



## USER MANUAL

Step-by-step guide to accessing all the functions  
of the Finder Bliss2 smart thermostat  
Type 1C.B1.9.005.0007

# BLISS2

# CONTENTS

EASY INSTALLATION	page 1
OVERVIEW OF SCREENS & ICONS	page 3
MANUAL MODE	page 4
ON/OFF MODE	page 5
AUTOMATIC MODE	page 6
HUMIDITY	page 7
GATEWAY ASSOCIATION	page 8
TRANSMISSION TEST WITH THE GATEWAY	page 9
HEATING/COOLING	page 10
GATEWAY SET-UP	page 12

## TECHNICAL SPECIFICATION

Power supply: 3x1.5 V alkaline batteries type AAA - LR03  
Temperature adjustment: (+5...+37)°C  
Resolution: 0.1°C  
Degree of protection: IP20  
Output: 5 A 250 V AC changeover volt-free contact  
Mounting: Wall

## INSTALLATION NOTES

### SAFETY REQUIREMENTS

The installation and assembly of electrical equipment must be performed by experienced personnel. Before connecting the thermostat, make sure that the load (pump, valve, boiler, etc.) is not powered and that it falls within the thermostat's contact rating.

### POSITIONING

Install the thermostat away from heat sources (radiators, direct sunlight, kitchens), away from doors/windows, and mount approximately 1.5 meters above floor level.

## FIXING BASE TO WALL

First, detach thermostat from its base by inserting two fingers into the central rear hole and, with the other hand, pull the front of the thermostat towards you.

### FIXING BASE

Secure the Smart Bliss2 thermostat base to the wall using the screws included in the package. When fixing, be careful not to over-tighten the screws to avoid damaging the base.

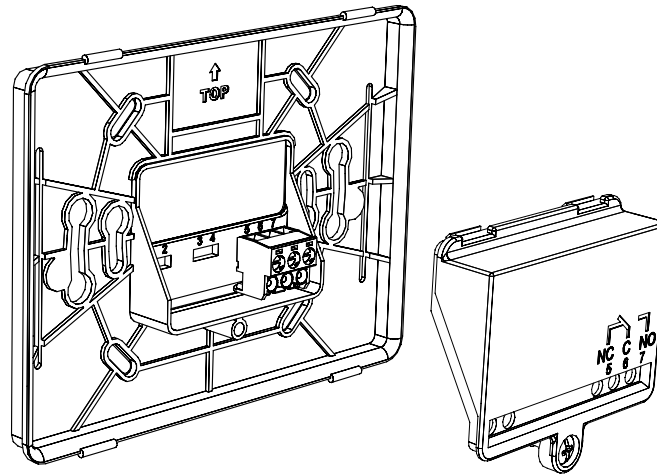

## ELECTRICAL CONNECTIONS

To make the connections, first refer to instructions for your heating system (pump, valve, boiler, etc.), then remove the terminal cover and connect the appropriate wires to terminals 6 (COM) and 7 (NO) of the Smart Bliss2 thermostat.

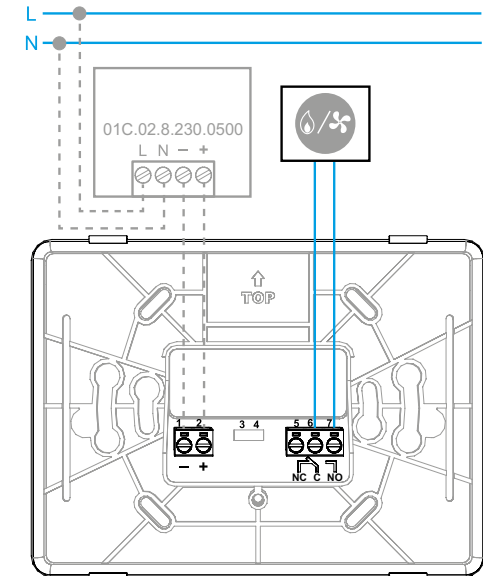

Type 01C.02.8.230.0500: OPTIONAL power supply

Using the external power supply, the batteries **MUST** be removed.

## BATTERY INSERTION AND MOUNTING

### THE THERMOSTAT

- Insert 3 x 1.5V alkaline batteries type AAA - LR03, paying attention to the indicated polarity.

After inserting the batteries, initialization screens will appear.

Wait for this process to finish and the detected temperature will then appear.

- Mount the thermostat to its base by first engaging the bottom part of the thermostat with the lower pins of the base plate, then close the upper part of the thermostat to lock onto the upper pins.

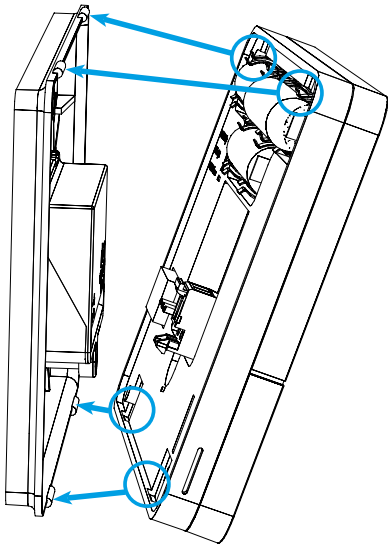

The thermostat is now ready to be configured.

However, the Gateway2 (1Y.GU.005.1) must first be installed.

## GATEWAY2 INSTALLATION

Connect the Micro USB connector to the Gateway2 (1Y.GU.005.1) and plug the power supply into the electrical outlet.

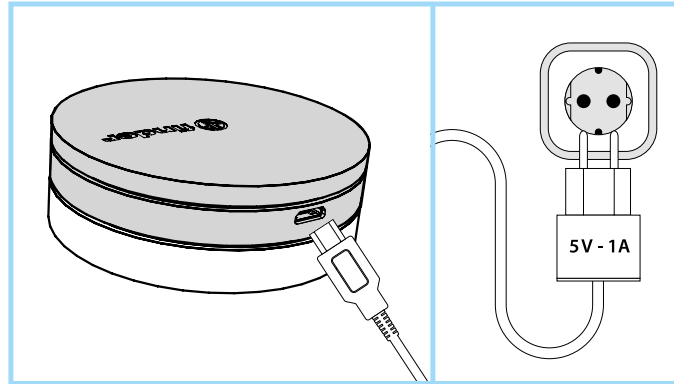

After switching on, the luminous base of the Gateway2 flashes with a fading white light - which indicates it is awaiting configuration.

### CONFIGURATION

To configure the Gateway2 and the Smart Bliss2 Thermostat, download the Finder Bliss application from the Google Play Store or the Apple Store and proceed with the configuration following the tutorial on the App. When requested by the App, activate the association of the thermostat following the following screens:

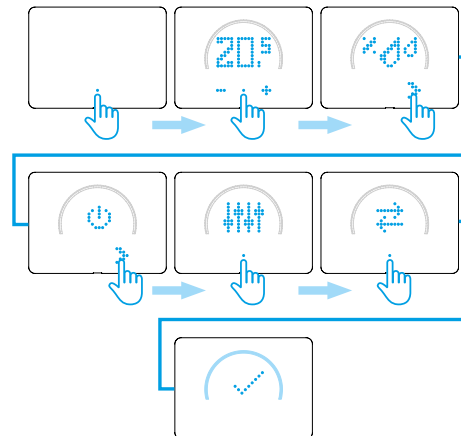

When done, the temperature detected by the Smart Bliss2 thermostat will be displayed in the application.

### THE LUMINOUS BASE - NOTES

#### WHITE LED

- **Fading flashing:** waiting for configuration
- **Fixed:** Wi-Fi network and Cloud connection present
- **2 Flashes:** Connected to the Wi-Fi network but no connection to the Cloud (Check your Internet connection)
- **3 Flashes:** No connection to the Wi-Fi network and no connection to the Cloud (Check your Wi-Fi network)

#### BLUE LED

- **Flashing:** sending Bluetooth commands

#### RED LED

- **Flashing:** sending commands to the Smart Bliss2 Thermostat

To change the light intensity of the GATEWAY2 base, press the button:

- 1 Once: Low brightness
- 2 times: Medium-Low brightness
- 3 times: Medium-High brightness
- 4 times: High brightness

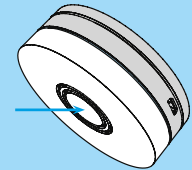

#### RESET

Press the button for > 10 seconds to restore factory settings



Bliss





**ROOM TEMPERATURE**  
Thermostat is set to AUTOMATIC mode (AUTO) and will respond to programming via the App. Current room temperature is displayed.

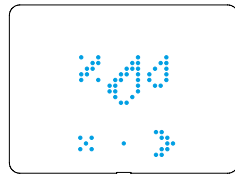

**HUMIDITY DETECTED IN THE ATMOSPHERE**  
In this section you can opt to view the level of humidity in the atmosphere (% RH).

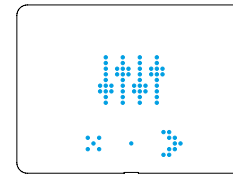

**SETTINGS MENU**  
From here you can access the device settings.



**TARGET TEMPERATURE IN MANUAL MODE**  
The thermostat is set to MANUAL mode. The target temperature is displayed.



**%RH**  
Display of Relative Humidity currently present in the atmosphere.

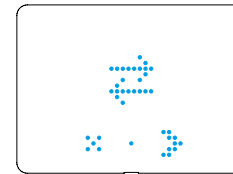

**ASSOCIATION WITH THE GATEWAY**  
The opposing arrows will flash only during the gateway pairing procedure.

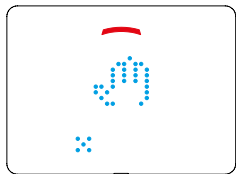

**MANUAL MODE**  
Thermostat is set to Manual mode. If the small arc segment at the top is coloured, the heating or cooling system is active. If red - heating If blue - cooling.

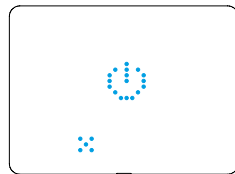

**ON/OFF SECTION**  
In this section you can turn the thermostat ON or OFF.



**TRANSMISSION TEST WITH THE GATEWAY**  
At this point in the menu you can perform a signal transmission test between the gateway and the thermostat.

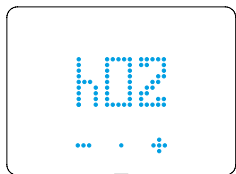

**HOURS SETTING**  
This displays the number of hours for which the manual mode is to apply. From 1 hour (h01) to permanent (h∞).

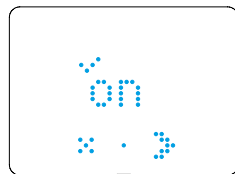

**ON MODE**  
With ON mode selected, the thermostat can function in either AUTO or Manual modes.

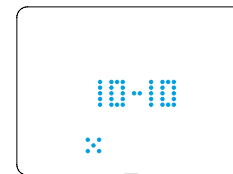

**RESULT OF THE TRANSMISSION TEST WITH THE GATEWAY**  
0 SIGNAL ABSENT: the gateway is unreachable  
1/6 POOR: bring the two devices closer  
7/8 GOOD: make changes only if errors are found  
9/10 VERY GOOD: stable connection.

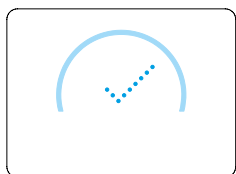

**FULL ARC**  
Appears when a setting is accepted and when the heating or cooling system is active.

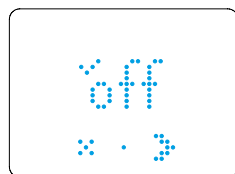

**OFF MODE**  
With the OFF mode selected, the thermostat will still maintain a frost protection setting of + 5°C to avoid freeze damage to the system.

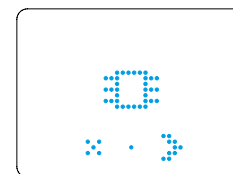

**FIRMWARE VERSION**  
At this point in the menu it is possible to view the firmware version present on the device.

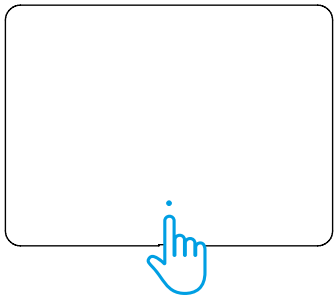

With the display off, press the point to turn the display on.

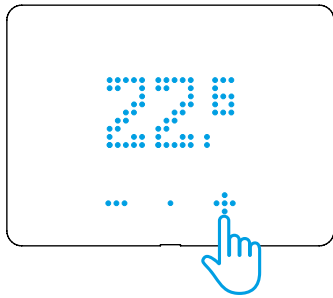
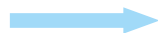

To change the target temperature, press + or - on the main screen.

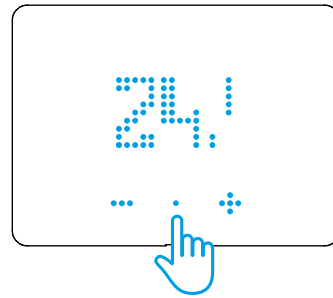
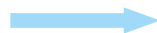

With the target temperature showing, confirm by pressing the point.

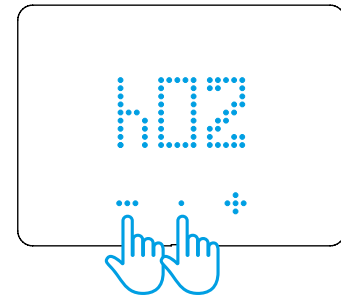
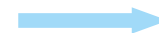

To set the number of hours for which the manual mode is to apply (after which it will return to the AUTO (weekly) mode). Press the + to increase the hours h01 = 1 hour, h02 = 2 hours, ... Pressing the - until «h∞» is displayed will set the permanent manual mode (until this is canceled via the App or thermostat.) Confirm by pressing the center point.

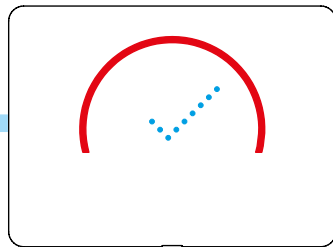
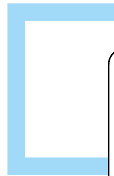

The arc will turn red if it is set on heating or blue if it is on cooling.

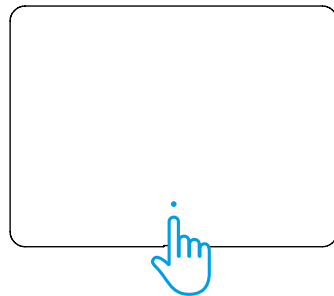

With the display off, press the point to turn the display on.

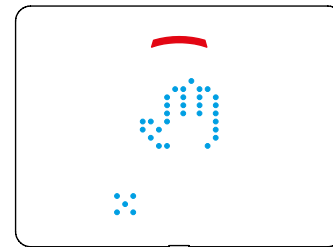

The small top segment of the arc will show either red or blue, indicating respectively that the heating or cooling system is active. Press X to cancel Manual operation and to return to AUTO operation.

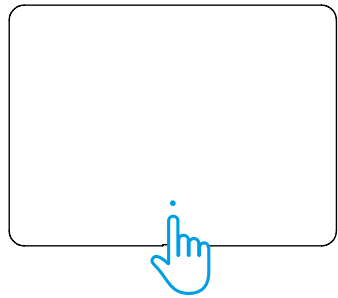

With the display off, press the point to turn the display on.

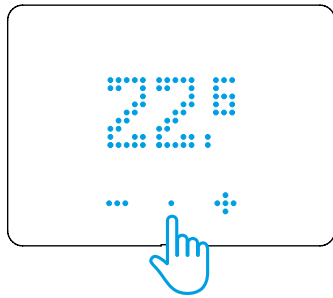

Press the point to access the internal menu.

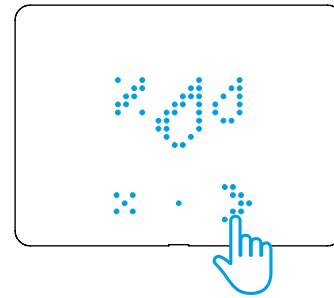

The "humidity" section will be displayed as it is the first item in the menu. Press on the right arrow to move on from the RH section.

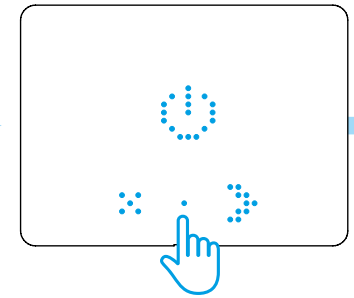

Press on the point to confirm if you wish to enter the ON/OFF section.

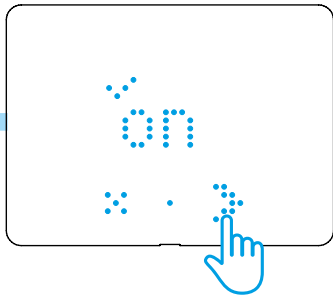

This screen indicates with the "√" that the thermostat is currently ON. Press the right arrow if you wish to change this.

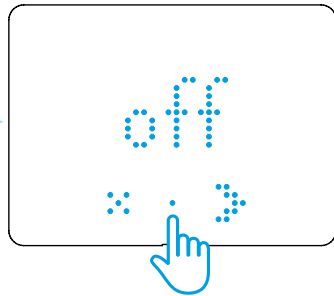

Press on the point to confirm you wish to select the OFF state.

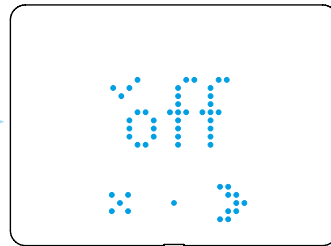

OFF mode is confirmed as being correctly set. Exit the menu by pressing X, or wait for the display to time out.

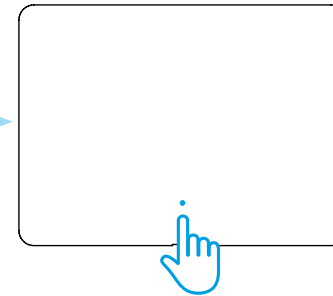

With the display off, press the point to turn the display on.

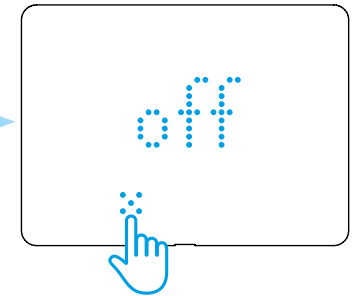

Press X to exit the ON/OFF mode.

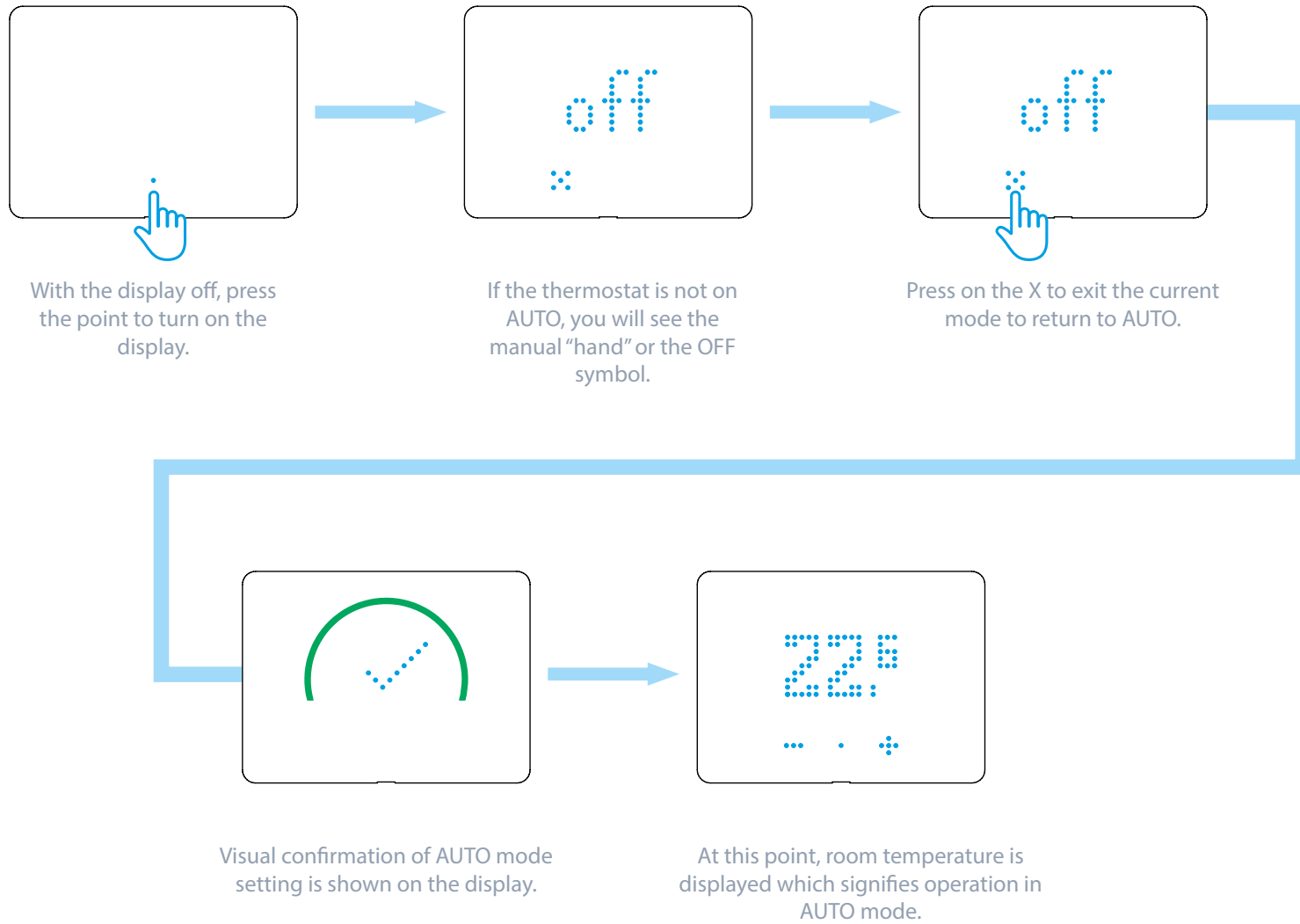



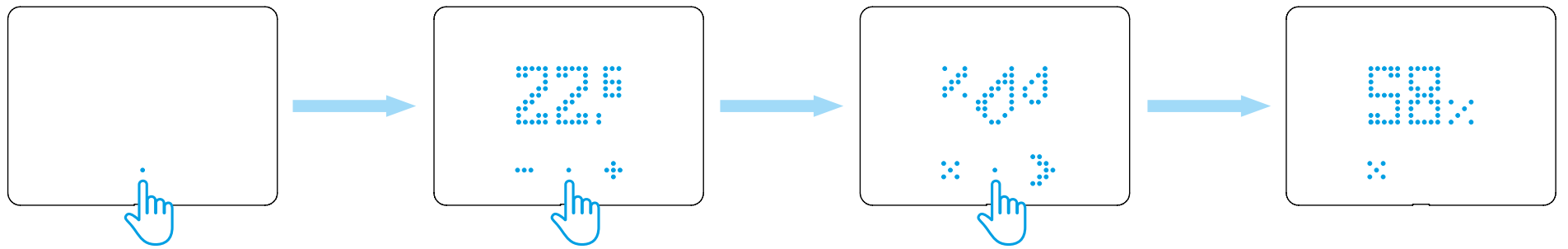

With the display off, press the point to turn the display on.

Press the point to access the internal menu.

The "humidity" section will be displayed as it is the first item in the menu. Press on the point to enter this section.

This screen shows the humidity (% RH). Press on the X to go back.

# ASSOCIATION WITH THE GATEWAY

BEFORE FOLLOWING THE ASSOCIATION PROCEDURE, OPEN THE BLISS APP AND ADD A NEW DEVICE

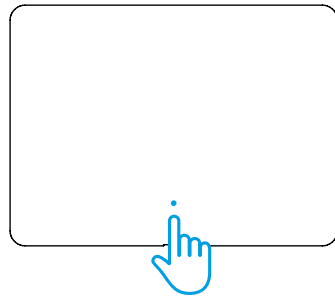

With the display off, press the point to turn the display on.

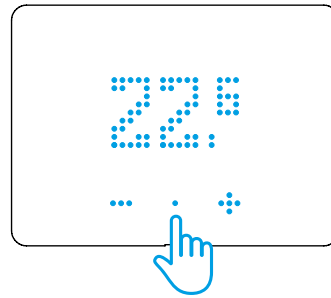

Press the point to access the internal menu.

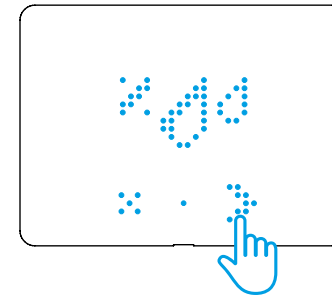

The "humidity" section will be displayed as it is the first item in the menu. Press on the right arrow to move on from the RH section.

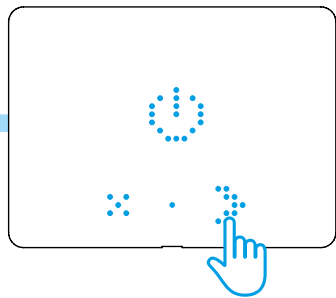

Press the right arrow to keep scrolling through the menu.

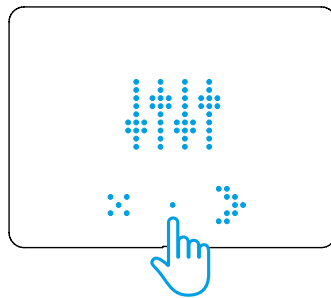

Press on the point to access the device settings.

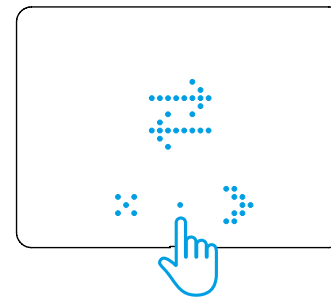

Press the point to put the thermostat into pairing mode. The opposing arrows will begin to flash.

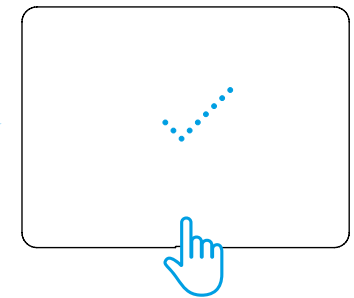

Visual confirmation of the correct association is shown on the display.

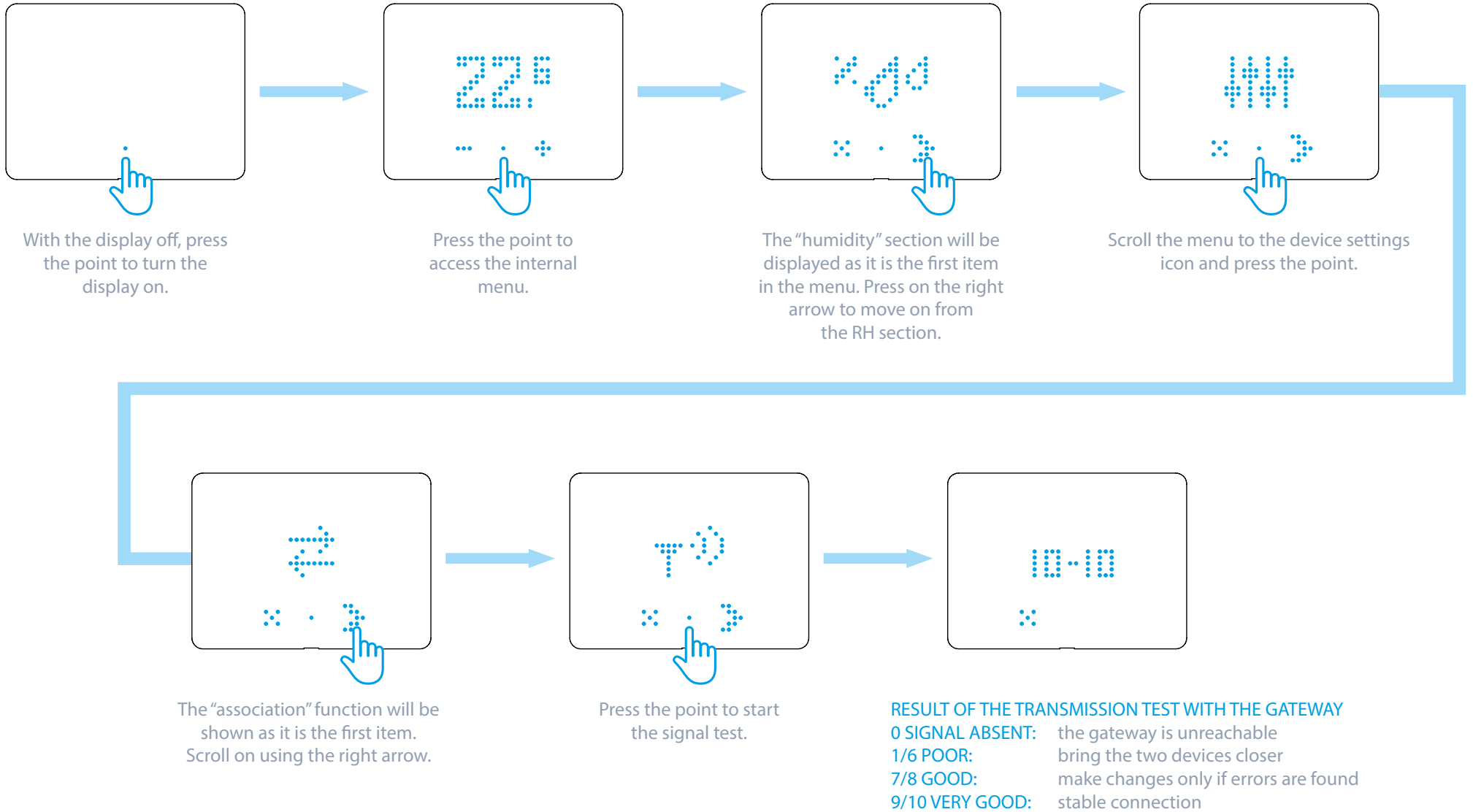

# HEATING/COOLING

ACCORDING TO THE OPERATING MODE OF THE THERMOSTAT, YOU WILL SEE DIFFERING VISUAL FEEDBACKS ON THE LUMINOUS ARC

## HEATING THE ARC IS RED

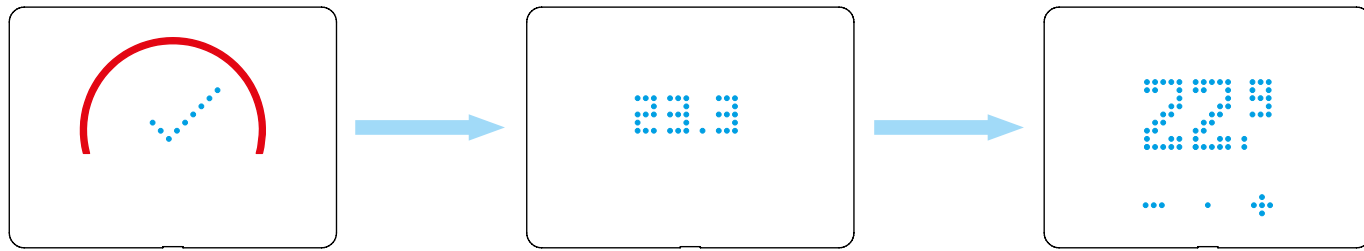

## COOLING THE ARC IS BLUE

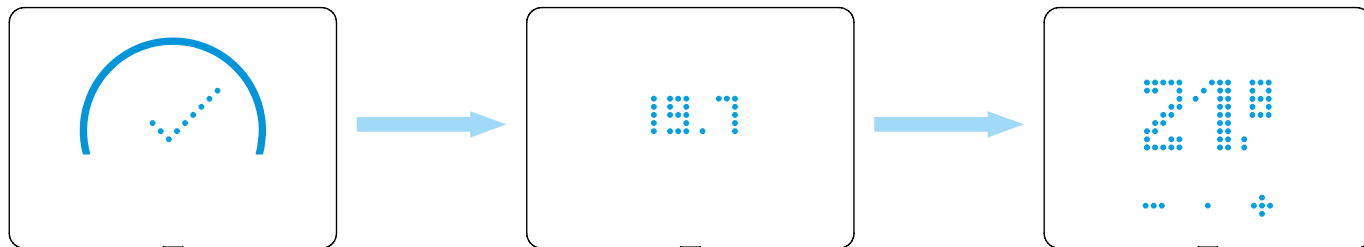



# INSTALLATION GUIDE

## 2nd GENERATION GATEWAY & BLISS2

2nd generation gateway Type 1Y.GU.005.1 & Smart Thermostat Bliss2  
Type 1C.B1.005.0007 configuration steps

## FIRST STEPS

Connect the gateway to the socket using the micro USB power supply before starting the procedure.

## IMPORTANT

The BLISS2 smart thermostat is only compatible with the second generation gateway Type 1Y.GU.005.1.

The code is shown under the black silicone cover at the top of the gateway.

The gateway works only with 2.4GHz Wi-Fi networks. Check that you have a 2.4GHz network configured on your home router and that you have the network name and password before starting the procedure.

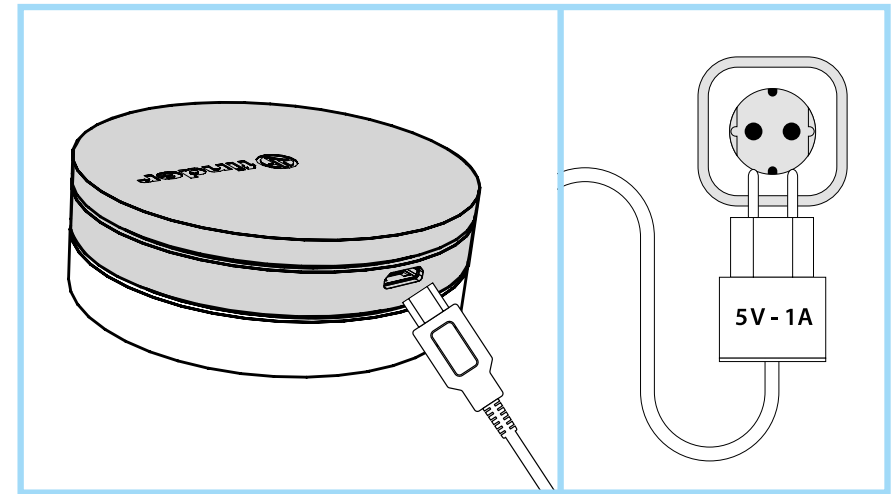

01

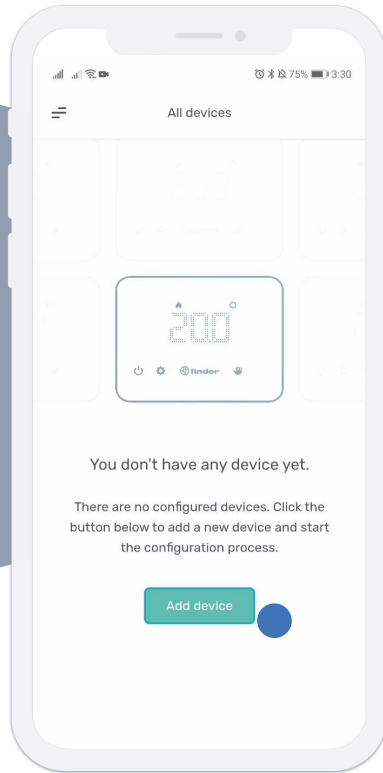

After logging in to the new Bliss app, click on "Add device" to start the association

Select "Bliss2" to star the association of the gateway and the thermostat.

02

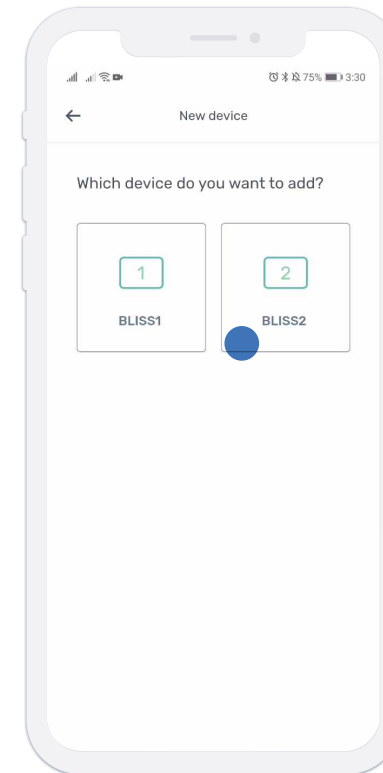

03

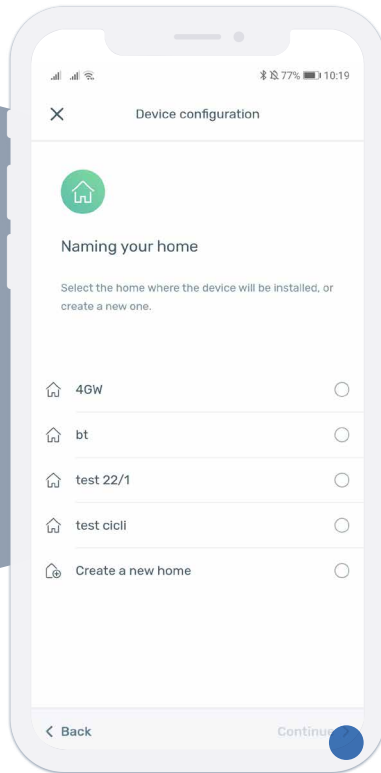

Select an existing house (created with Yesly) or create a new one to define which system the gateway belongs to. Then press "Continue".

Select the time zone you are in.  
The default is for Italy

04

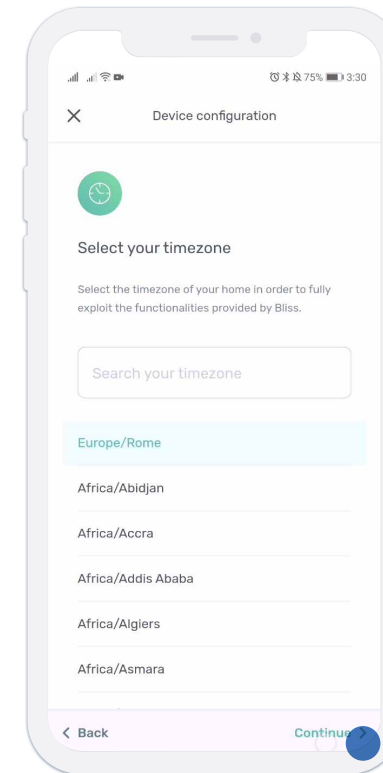



05

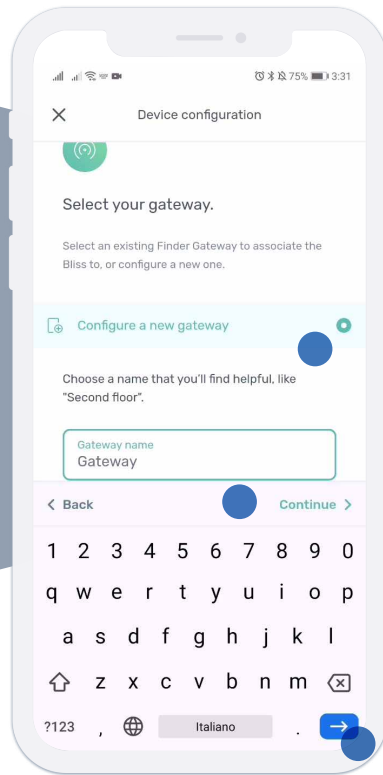

Select "Configure a new gateway" and give it a name. Then press "Continue".

After selecting the gateway to associate, choose to connect it to the Wi-Fi network. Then press "Continue".

06

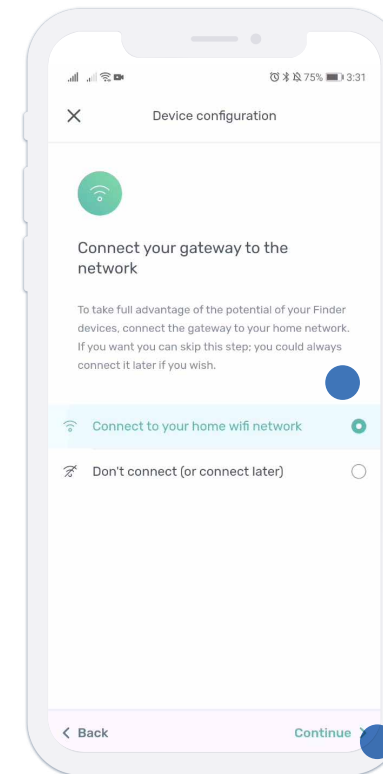

07

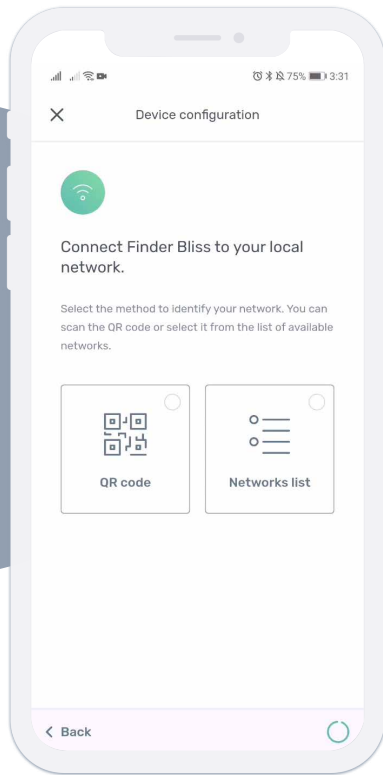

You can choose whether to associate the gateway to the network by selecting it from those available or by scanning the QR code located behind the router.

After choosing the network to associate with, the gateway will complete the association.

08

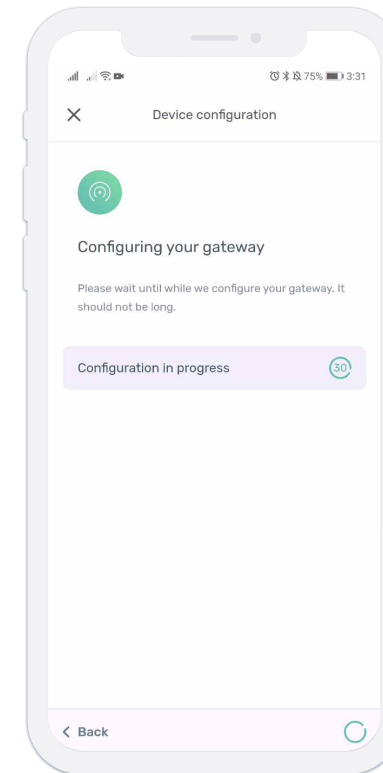

09

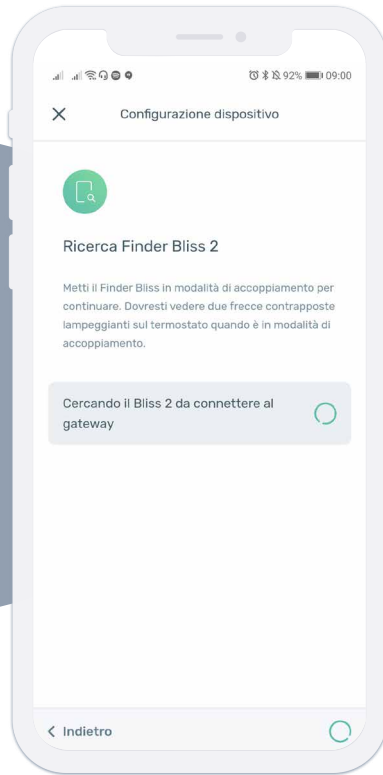

Now you need to put the Bliss2 thermostat in "connection" mode. Go to the device and make the arrows blink.

Execute this procedure on the Bliss2:

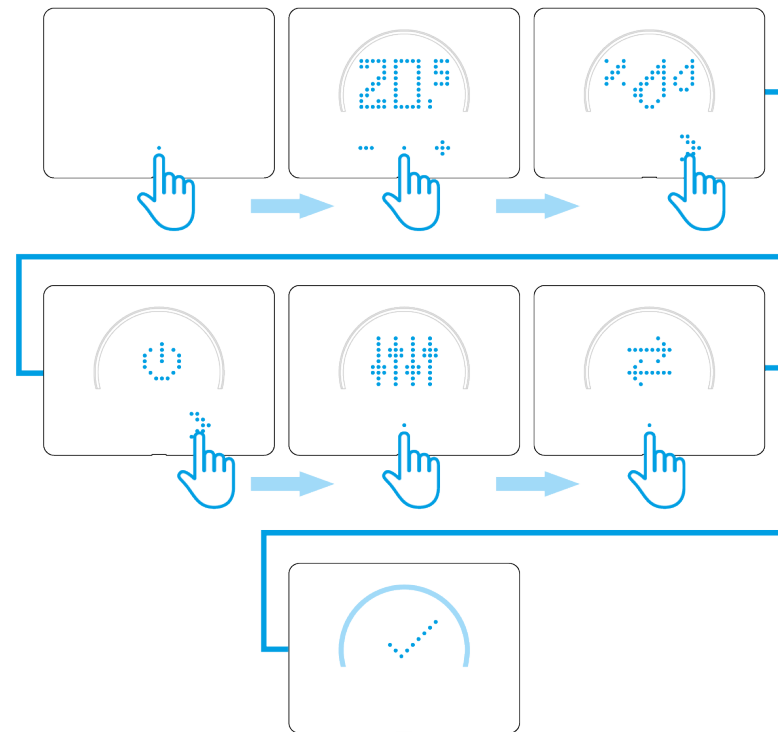

10

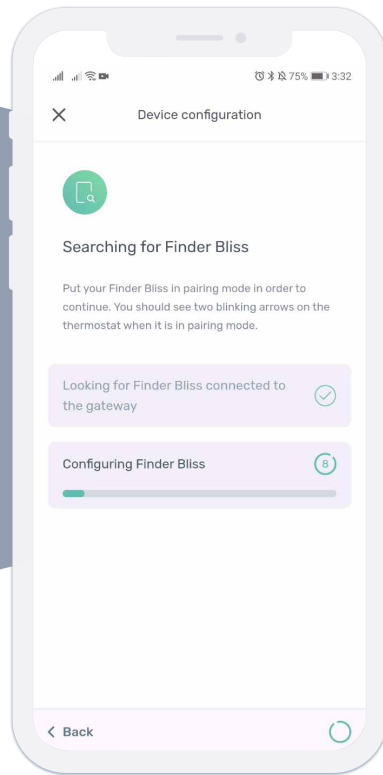

The gateway is now communicating with the Bliss2.  
Please, wait.

When the procedure is over,  
give the Bliss2 a name.

11

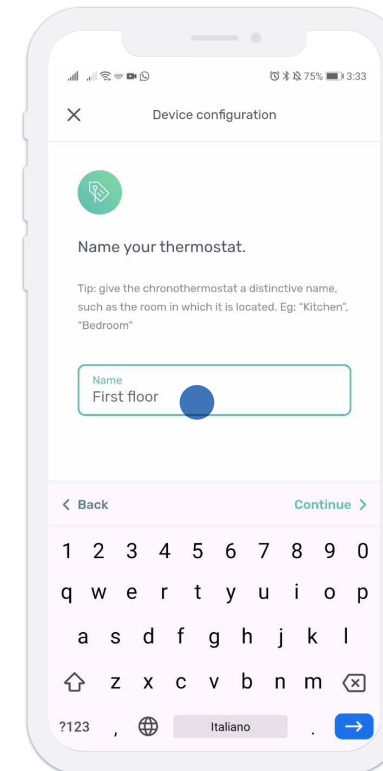

12

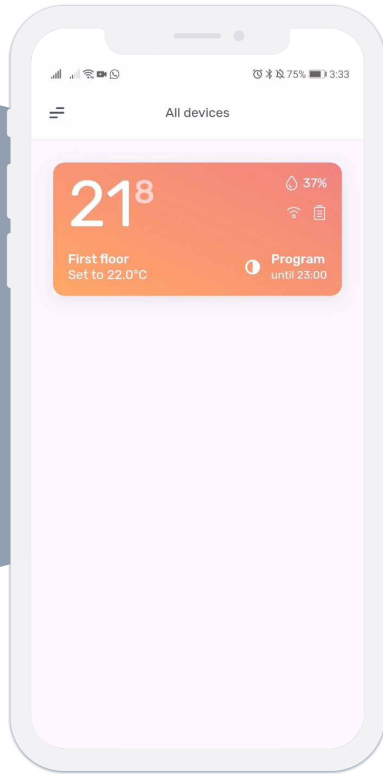

Finder Bliss2 is properly paired. Now all you have to do is configure the temperature schedule and discover the rest of the functions of your new Smart Bliss2 Thermostat.

 **FINDER SpA**  
Via Drubiaglio 14  
I-10040 ALMESE (TO)  
Tel. +39 011 9346 211  
Fax +39 011 9359 079  
export@findernet.com

 **FINDER FRANCE Sarl**  
Avenue d'Italie  
ZI du Pré de la Garde  
F - 73300 ST. JEAN DE MAURIENNE  
Tel.+33/479/83 27 27  
Fax +33/479/59 80 04  
finder.fr@finder.fr

 **FINDER GmbH**  
Hans-Böckler-Straße 44  
D - 65468 Trebur-Astheim  
Tel. +49 6147 2033-0  
Fax +49 6147 2033-377  
info@finder.de

 **FINDER BELGIUM SRL - BV**  
Bloemendael, 5  
B - 1547 BEVER  
Tel. +32/54/30 08 68  
Fax +32/54/ 30 08 67  
finder.be@findernet.com

 **FINDER P.L.C.**  
Opal Way - Stone Business Park  
STONE, STAFFORDSHIRE  
ST15 0SS - UK  
Tel: +44 (0)1785 818100  
Fax: +44 (0)1785 815500  
finder.uk@findernet.com

 **FINDER RELAIS NEDERLAND B.V.**  
Dukdalfweg 51  
1041 BC AMSTERDAM - NEDERLAND  
Tel. +31/20/615 65 57  
Fax +31/20/617 89 92  
finder.nl@findernet.com

 **FINDER RELAIS VERTRIEBS GmbH**  
IZ NÖ-Süd, Str. 2a, Obj. M 40  
A - 2351 Wiener Neudorf  
Tel. +43/2236/86 41 36 - 0  
Fax +43/2236/86 41 36 - 36  
finder.at@findernet.com

 **FINDER CZ, s.r.o.**  
Radiová 1567/2b  
CZ - 102 00 PRAHA 10  
Tel. +420 286 889 504  
Fax +420 286 889 505  
finder.cz@findernet.com

 **FINDER AB**  
Sångelekgatan 6c  
SE - 215 79 Malmö  
Tel: +46 (0) 40 93 77 77  
Fax:+46 (0) 40 93 78 78  
finder.se@findernet.com

 **FINDER ApS**  
Bøstrupvej 11  
DK-8870 Langå  
Tel. +45 69 15 02 10  
Fax +45 69 15 02 11  
finder.dk@findernet.com

 **FINDER ELECTRICA S.L.U.**  
C/ Severo Ochoa, 6  
Pol. Ind. Cap de L'Horta  
E - 46185 La Pobla de Vallbona (VALENCIA)  
Apdo Postal 234  
Telf. Oficina Comercial 93 836 51 30  
finder.es@findernet.com

 **FINDER - Hungary Kereskedelmi Kft.**  
Kiss Ernő u. 3/A.  
HU - 1046 BUDAPEST  
Tel. +36/1-369-30-54  
Fax +36/1-369-34-54  
finder.hu@findernet.com

 **FINDER PORTUGAL LDA**  
Travessa Campo da Telheira, n. 56  
Vila Nova da Telha,  
P - 4470-828 - MAIA  
Tel. +351 22 99 42 900 -1-6-7-8  
Fax +351 22 99 42 902  
finder.pt@findernet.com

 **FINDER (Schweiz) AG**  
Industriestrasse 1a Postfach 23  
CH - 8157 DIELSDORF (ZH)  
Tel. +41 44 885 30 10  
Fax +41 44 885 30 20  
finder.ch@finder-relais.ch

 **FINDER RELAYS, INC.**  
4191 Capital View Drive  
Suwanee, GA 30024 - U.S.A.  
Tel. +1/770/271-4431  
finder.us@findernet.com

 **FINDER ECHIPAMENTE srl**  
Str. Clujului nr. 75 F,  
401180 Turda  
Jud. CLUJ - ROMANIA  
Tel. +40 264 403 888  
Fax +40 264 403 889  
finder.ro@finder.ro

 **RELEVADORES FINDER, S.A. de C.V**  
Carretera a San Bernardino Chalchihuapan #43  
San Pablo Ahuatempan, Santa Isabel Cholula, Puebla.  
C.P. 74350 - MÉXICO.  
Tel. +52/222/2832392, 2832393, 2832394  
Fax. +52/222/7628471  
finder.mx@findernet.com

 **FINDER OOO**  
Bakuninskaya street, 78/1  
105082 MOSCOW  
RUSSIAN FEDERATION  
Tel. +7/495/229-49-29  
Fax +7/495/229-49-42  
finder.ru@findernet.com

 **FINDER COMPONENTES LTDA.**  
Rua Olavo Bilac, 326  
Bairro Santo Antônio  
São Caetano Do Sul - São Paulo  
CEP 09530 - 260 - BRASIL  
Tel. +55 11 4223 1550  
Tel. +55 11 2147 1550  
Fax +55 11 4223 1590  
finder.br@findernet.com

 **FINDER ARGENTINA S.R.L**  
Calle Martín Lezica 3079  
San Isidro - Buenos Aires  
CP B1642GJA - ARGENTINA  
Tel +54/11/5648.6576  
Fax +54/11/5648.6577  
finder.ar@findernet.com

 **FINDER ASIA Ltd.**  
Room 901 - 903, 9F, Premier  
Center20 Cheung Shun Street  
Cheung Sha Wan, Kowloon  
Hong Kong  
Tel. +852 3188 0212  
Fax +852 3188 0263  
finder.hk@findernet.com

 **FINDER Polska Sp. z o.o.**  
ul. Logistyczna 27  
62-080 Sady  
Tel. +48 61 865 94 07  
Fax +48 61 865 94 26  
finder.pl@findernet.com

 **FINDER INDIA PVT. LTD.**  
Unit No.912 - R.G. Trade Tower,  
Netaji Subhash Place,  
Wazirpur District Centre,  
Pitampura - Delhi - 110034 - INDIA  
Tel. +91-11-47564343  
Fax +91-11-47564344  
finder.in@findernet.com

 **FINDER BALTIC, UAB**  
Eiguliu str. 9-1  
Vilnius, LT-03150  
Lithuania  
Tel. +370 526 53 027  
finder.lt@findernet.com

 **FINDER LATAM S.A.**  
Logistic Center for South America  
Ruta 8 km 17.500 - Edificio Quantum - O  
CP: 91600 - Zonamerica - Montevideo -  
finder.latam@findernet.com

 **FINDER COMPONENTS INC.**  
5028 South Service Road  
Burlington, ONTARIO L7L 5Y7  
Toll Free 1 800 265 6263  
Local 905 681 7767  
finder.ca@findernet.com

 **FINDER d.o.o.**  
Skapinova ulica 2a  
1000 Ljubljana, Slovenija  
Tel. +386 820 09931  
sales.si@findernet.com