

# COUNTIS *E43/E44*

Three-phase Energy meter Measure via CT  
up to 12 000A - RS485 MODBUS

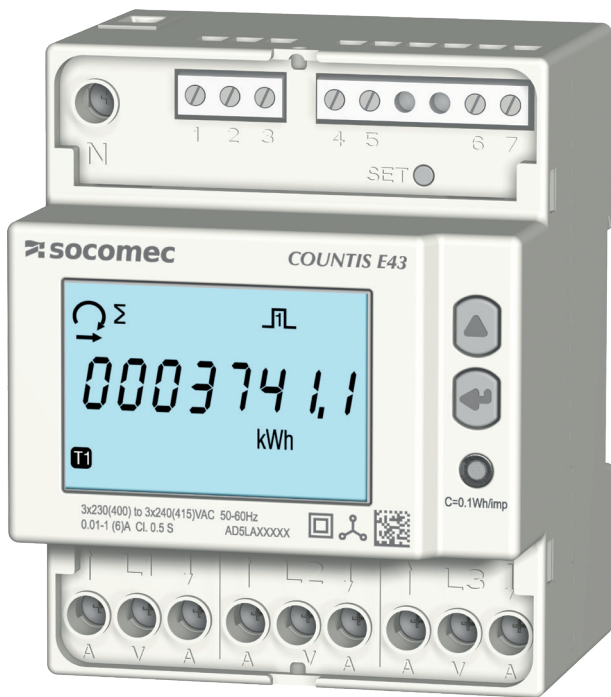

COUNTIS E43

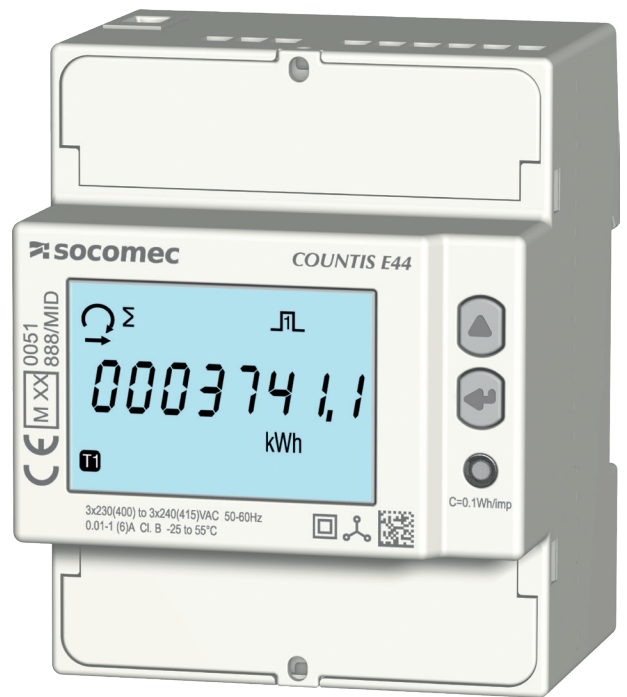

COUNTIS E44 - MID



1. DOCUMENTATION . . . . .	4
2. HAZARDS AND WARNINGS . . . . .	4
2.1. RISK OF ELECTROCUTION, BURNS OR EXPLOSION . . . . .	4
2.2. RISK OF DAMAGING THE UNIT . . . . .	4
2.3. RESPONSIBILITY . . . . .	4
3. PRELIMINARY OPERATIONS . . . . .	5
4. INTRODUCTION . . . . .	6
4.1. INTRODUCING THE COUNTIS E43/E44 . . . . .	6
4.2. FUNCTIONS . . . . .	6
4.3. FRONT PANEL . . . . .	6
4.4. LCD DISPLAY . . . . .	7
4.5. DIMENSIONS . . . . .	7
4.6. ELECTRICAL VALUES MEASURED . . . . .	8
4.6.1. MEASUREMENTS . . . . .	8
4.6.2. ENERGY BALANCE; DEFINITION . . . . .	9
5. INSTALLATION . . . . .	9
5.1. RECOMMENDATIONS AND SAFETY . . . . .	9
5.2. DIN RAIL MOUNTED . . . . .	9
6. CONNECTION . . . . .	10
6.1. CONNECTING THE COUNTIS E43/E44 . . . . .	10
6.2. CONNECTION TO THE ELECTRICAL NETWORK AND TO THE LOADS . . . . .	10
7. MID COMPLIANCE . . . . .	11
8. COMMUNICATION . . . . .	12
8.1. GENERAL INFORMATION . . . . .	12
8.2. RS485 RULES . . . . .	12
8.3. COMMUNICATION STRUCTURE . . . . .	13
8.4. COMMUNICATION TABLES . . . . .	13
9. CONFIGURATION . . . . .	14
9.1. ONSCREEN CONFIGURATION . . . . .	14
9.1.1. DETAILED VIEW OF MENU "SETUP 1" . . . . .	14
9.1.2. VIEW ALL OF THE MENU "SETUP 2" . . . . .	15
9.1.3. DETAILED VIEW OF MENU "SETUP 2" . . . . .	16
9.1.4. EXAMPLE: SETTING THE COMMUNICATION ADDRESS . . . . .	17
10. USE . . . . .	18
10.1. DETAILED VIEW OF THE MENU FOR TARIFF 1, "TAR.1" . . . . .	19
10.2. DETAILED VIEW OF THE MENU FOR TARIFF 2, "TAR.2" . . . . .	20
10.3. DETAILED VIEW OF THE MENU FOR TARIFF 3, "TAR.3" . . . . .	21
10.4. DETAILED VIEW OF THE MENU FOR TARIFF 4, "TAR.4" . . . . .	22
10.5. DETAILED VIEW OF THE TOTAL MENU, "TOT" . . . . .	23
10.6. DETAILED VIEW OF THE MENU SHOWING PARTIAL READINGS AND THE ENERGY BALANCE "PAR.B" . . . . .	24
10.6.1. STARTING UP THE PARTIAL ENERGY METER . . . . .	25
10.6.2. STOPPING THE PARTIAL ENERGY METER . . . . .	25
10.6.3. RESETTING THE PARTIAL ENERGY METER TO ZERO . . . . .	25
10.7. DETAILED VIEW OF THE MENU FOR REALTIME READINGS, "RT" . . . . .	26
10.8. DETAILED VIEW OF THE MENU "INFO" . . . . .	27

11. DIAGNOSTICS MESSAGES.....	28
11.1. MISSING PHASES .....	28
11.2. REVERSED PHASES .....	28
11.3. MALFUNCTION.....	28
12. ASSISTANCE .....	29
13. CHARACTERISTICS.....	30
14. GLOSSARY OF ABBREVIATIONS .....	33

# 1. DOCUMENTATION

All documentation on the COUNTIS E43/E44 is available on our website at the following address:  
[www.socomec.com/en/countis-e4x](http://www.socomec.com/en/countis-e4x)



## 2. HAZARDS AND WARNINGS

The term "device" used in the paragraphs below refers to the COUNTIS E43/E44.

The assembly, use, servicing and maintenance of this equipment must only be carried out by trained, qualified professionals. SOCOMEC shall not be held responsible for failure to comply with the instructions in this manual.

### 2.1. Risk of electrocution, burns or explosion

- This device must only be installed and serviced by qualified personnel who have in-depth knowledge of installing, commissioning and operating the device and who have had appropriate training. He or she should have read and understood the various safety measures and warnings stated in the instructions.
- Before carrying out any work on the unit, switch off the voltage inputs.
- Always use an appropriate voltage detection device to confirm the absence of voltage.
- Replace all devices, doors and covers before turning on power to this equipment.
- Always power the device with the correct rated voltage.
- Install the unit following the recommended installation instructions and in a suitable electrical cabinet.

**Failure to take these precautions could cause death or serious injuries.**

### 2.2. Risk of damaging the unit

To ensure that the unit operates correctly, make sure that:

- The unit is correctly installed.
- There is a maximum voltage at the voltage input terminals of 288 VAC phase-neutral
- The network frequency indicated on the device is observed: 50 or 60 Hz.
- There is a maximum current of 6 A at the current input terminals (I1, I2 and I3).

**Failure to respect these precautions could cause damage to the unit.**

### 2.3. Responsibility

- Assembly, connection and use must be carried out in accordance with the installation standards currently in force.
- The unit must be installed in accordance with the rules given in this manual.
- Failure to observe the rules for installing this unit may compromise the device's intrinsic protection.
- The unit must be positioned within an installation which complies with the standards currently in force.
- Any cable which needs to be replaced may only be replaced with a cable having the correct rating.

### 3. PRELIMINARY OPERATIONS

To ensure the safety of staff and the equipment, it is vital to read and absorb the contents of these instructions thoroughly before commissioning.

Check the following points as soon as you receive the package containing the unit:

- The packaging is in good condition
- The unit has not been damaged during transportation
- The device reference number conforms to your order
- The package includes:
  - 1 device
  - 1 sealing kit (for COUNTIS E44)
  - 1 Quick Start guide

## 4. INTRODUCTION

### 4.1. Introducing the COUNTIS E43/E44

The COUNTIS E43/E44 are modular active and reactive electrical energy meters that displays consumed and produced energy. They are designed for three-phase networks and can be connected using a CT 1/5 A on installations up to 12000 A.

### 4.2. Functions

- Measures and displays bidirectional total and partial energy
- Four tariff management : T1 / T2 / T3 / T4
- Pulse output
- Electrical parameter measurements: I, U, V, f
- Bidirectional Power, power factor
- RS 485 Modbus communication
- MID version (according to reference)

Description	Reference
COUNTIS E43	4850 3065
COUNTIS E44	4850 3066

### 4.3. Front panel

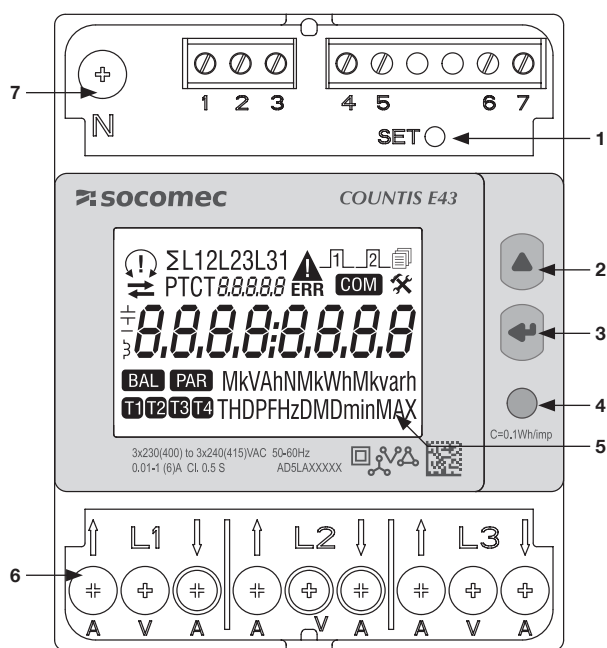

1. SET button
2. UP button
3. ENTER key
4. Metrological LED
5. LCD display
6. Current and voltage terminals
7. Neutral connection

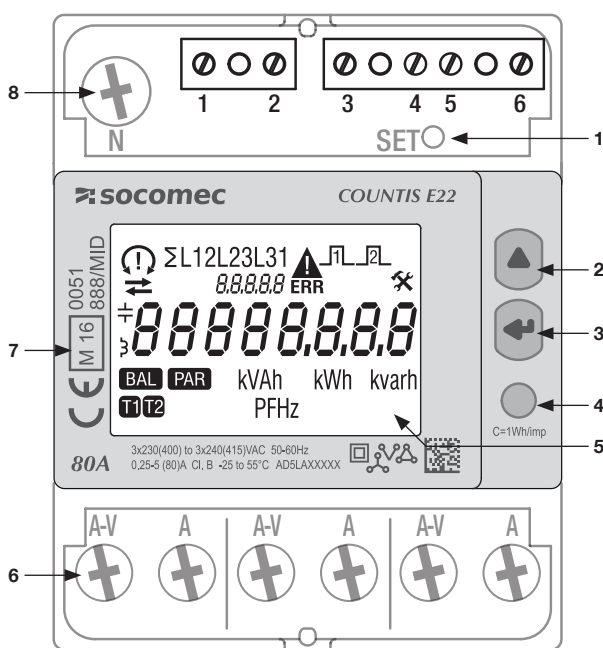

1. SET button
2. UP button
3. ENTER key
4. Metrological LED
5. LCD display
6. Current and voltage terminals
7. Information relating to MID certification
8. Neutral connection

## 4.4. LCD display

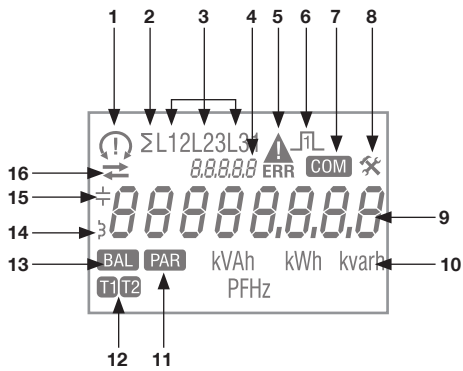

1. Phase sequences:
  - ↻ 132
  - ↻ 123
  - ✖ one or multiple phases are not detected
2. System value
3. Value by phase
4. Identification of current menu
5. Device malfunction. Replace the device
6. Active pulse output
7. Active communication
8. Setup menu
9. Main zone
10. Measurement Unit
11. Partials meters. Flashing = partial meter has stopped
12. Tariff display
13. Energy balance
14. Inductive value
15. Capacitive value
16. Imported (↔) or exported energy or power (↔)

## 4.5. Dimensions

Dimensions: in/mm

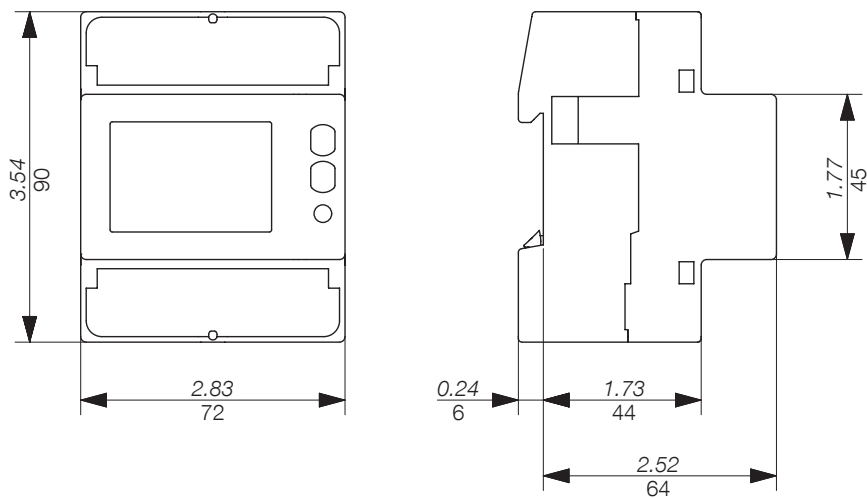

## 4.6. Electrical values measured

### 4.6.1. Measurements

Settings vary by model.

Realtime values	Symbol	Measurement Unit	LCD display	Via communication
Phase to neutral voltage	$\sum V$	V	●	●
	V1, V2, V3			●
Phase to phase voltage	$\sum U$		●	●
	U12, U23, U31			●
Current	$\sum I$	A	●	●
	I1, I2, I3, IN			●
Power factor	$\sum PF$		●	●
	PF1, PF2, PF3			●
Apparent power	$\sum S, S1, S2, S3$	kVA	●	●
Active power	$\sum P, P1, P2, P3$	kW	●	●
Reactive power	$\sum Q, Q1, Q2, Q3$	kVAr	●	●
Frequency	f	Hz	●	●
Phase sequence	CW / CCW		●	●
Power direction	$\rightleftharpoons$		●	
<b>Logged data</b>				
Total active and reactive energy	Ea, Er ( $\sum$ & by phase)	kWh, kvarh	●	●
Total apparent energy	Eap ( $\sum$ )	kVAh	●	●
	Eap (by phase)			●
Total inductive and capacitive reactive energy	Er ( $\sum$ )	kvarh	●	●
	Er (by phase)			●
Total active, reactive energy for each tariff (T1/T2/T3/T4)	Ea, Er ( $\sum$ )	kWh, kvarh	●	●
	Ea, Er, Eap ( $\sum$ & by phase)	kWh, kvarh, kVAh		●
Total reactive, inductive and capacitive energy for each tariff (T1/T2/T3/T4)	Er ( $\sum$ )	kvarh	●	●
	Er (by phase)			●
Active, partial energy for each tariff (T1/T2/T3/T4)	Ea ( $\sum$ )	kWh	●	●
Active, reactive and apparent partial energy	Ea, Er, Eap ( $\sum$ )	kWh, kvarh, kVAh	●	●
Energy balance	$\sum$	kWh, kvarh	●	●
<b>Miscellaneous</b>				
Present tariff	T	1/2/3/4	●	●
Partial counters	BY	START/STOP	●	
Pulse output status	$\perp$ L	Active / inactive	●	

NOTE:  $\sum$  is the sum of the meter readings for each phase, divided by 3.

NOTE: If you have a 3-wire connection the following voltage readings are not available; phase-neutral, neutral current, phase power, power factor for each phase and power for each phase.



## 4.6.2. Energy balance; definition

	Formula
kWh	$(+kWh\ T1) - (-kWh\ T1) + (+kWh\ T2) - (-kWh\ T2)$
kvarh	$(+kvarh\ T1) - (-kvarh\ T1) + (+kvarh\ T2) - (-kvarh\ T2)$

# 5. INSTALLATION

The paragraphs below describe how to install the device.

## 5.1. Recommendations and safety

Refer to the safety instructions (section "2. Hazards and warnings", page 4)

- Keep away from electromagnetic interference generator systems,
- Avoid vibrations with accelerations greater than 1 g for frequencies lower than 60 Hz.

## 5.2. DIN rail mounted

The COUNTIS E43/E44 can be mounted on a 35-mm DIN rail (EN 60715TM35). It must be used inside electrical cabinets.

# 6. CONNECTION

## 6.1. Connecting the COUNTIS E43/E44

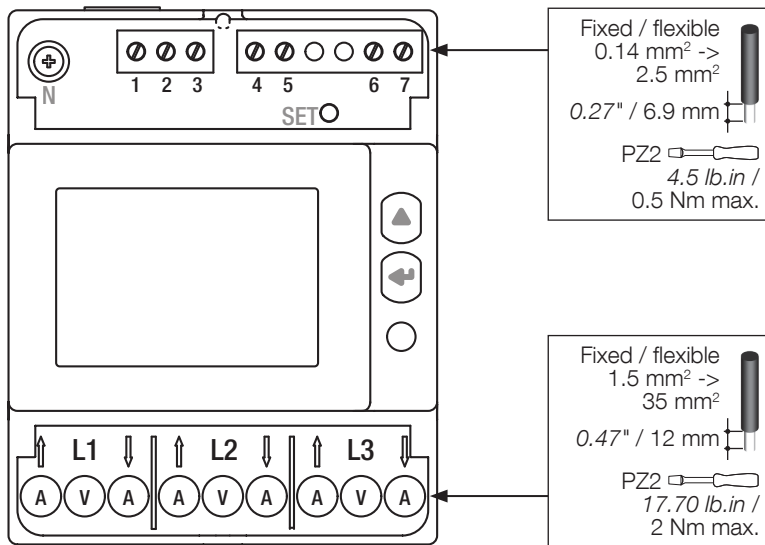

## 6.2. Connection to the electrical network and to the loads

The COUNTIS E43/E44 are intended for three-phase networks with neutral.

### 3 phases, 4 wires, 3 CT

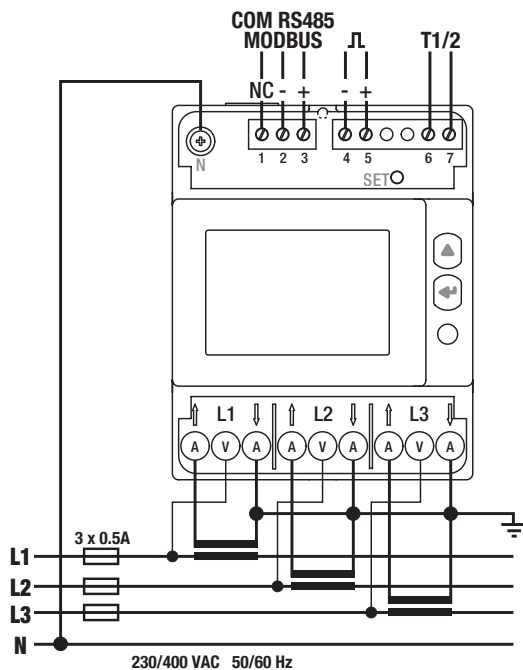

#### MODBUS

- 1: NC (not connected). May be used for shielding continuity.
- 2: -
- 3: +

#### Pulse output

- 4: -
- 5: +
- Optocoupler pulse outputs
- Terminals 4-5 must be supplied with voltage between 5 and 27 VDC (27mA max)

#### Double tariff

- 6-7: Switch tariffs:
- 0 VAC/DC -> Tariff 1
- 80-276 VAC/DC -> Tariff 2

#### Mains

- L1 A: Current input/output
- L1 V: Voltage input
- L2 A: Current input/output
- L2 V: Voltage input
- L3 A: Current input/output
- L3 V: Voltage input
- N: Neutral connection

## 7. MID COMPLIANCE

The following points must be taken into consideration to ensure that the device is used in compliance with directive MID 2014/32/EU:

- **Type of network**

The COUNTIS E44 meter complies with the MID directive for connection to networks: 3P+N and 3P (see "6.2. Connection to the electrical network and to the loads", page 10)

- **Fitting terminal covers**

After connecting the device, ensure that the terminal covers are fitted properly and secured by the plastic seals provided with the device.

- **Locking the program button**

Make sure the SET program button is locked after fitting the terminal cover.

- **RS485 communication**

The information provided via the RS485 COM is transmitted for information only and has no legal value.

- **MID Declaration of Conformity**

The MID Declaration of Conformity is available on the website: [www.socomec.com/en/countis-e4x](http://www.socomec.com/en/countis-e4x)

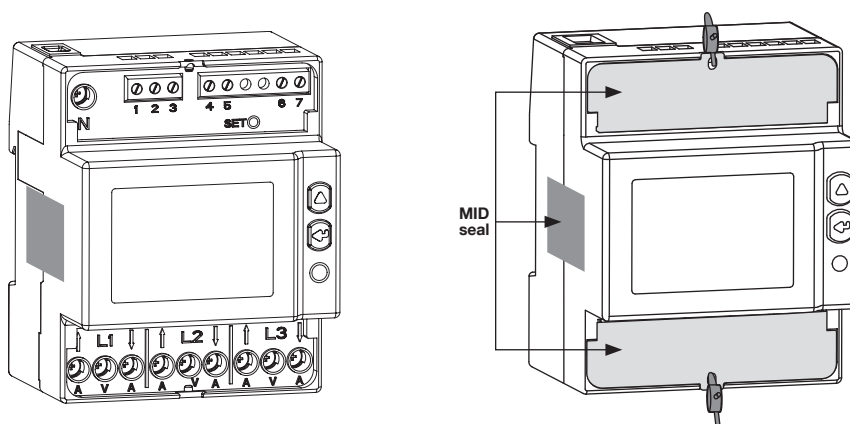

# 8. COMMUNICATION

## 8.1. General information

The Modbus communication available on the COUNTIS E43/E44 communicates via an RS485 series link (2 or 3 wires) which is used to operate devices from a PC or an API.

In a standard configuration an RS485 connection is used to connect 32 devices to a PC or a controller over 1200 metres.

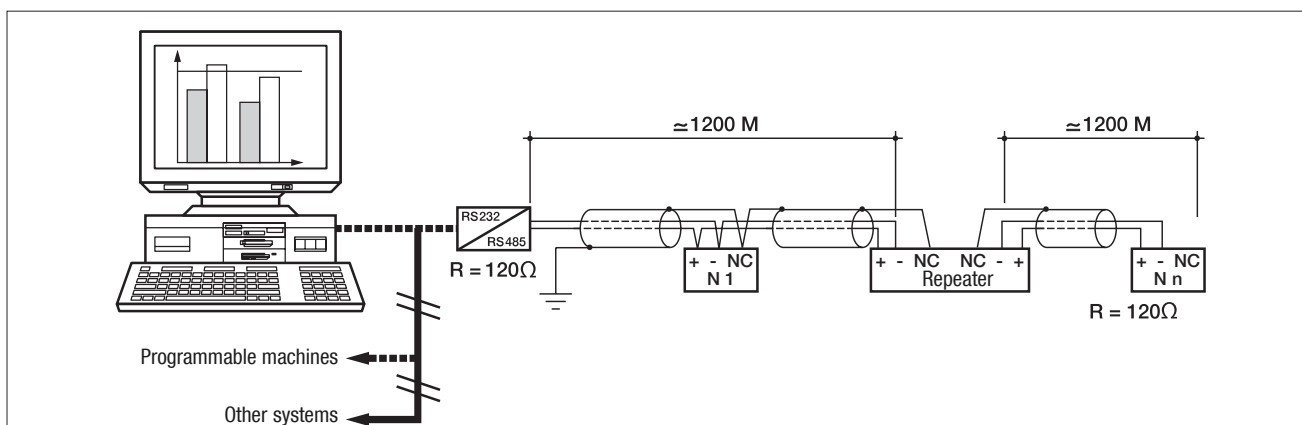
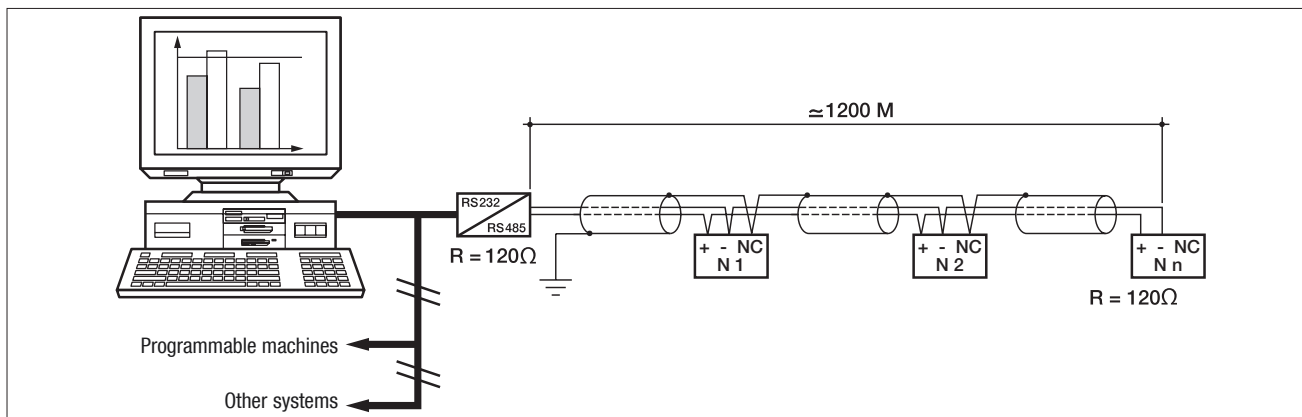

## 8.2. RS485 rules

A LIYCY shielded twisted pair must be used. We recommend using a shielded twisted pair with a general LIYCY-CY shielding in an environment where there is interference or in a very long network with a number of devices.

If the distance of 1200 m is exceeded and/or the number of devices is greater than 32, a repeater must be added to enable additional devices to be connected.

A 120 Ohm resistor must be fixed at both ends of the connection.

### 8.3. Communication structure

The device communicates via a Modbus protocol which involves a dialogue in accordance with a master/slave structure. The communication mode is the RTU (Remote Terminal Unit) mode with hexadecimal characters composed of at least 8 bits.

Modbus frame structure (master -> slave question):

Slave address	Function code	Address	Number of words to be read	CRC 16
1 byte	1 byte	2 bytes	2 bytes	2 bytes

To comply with the Modbus protocol, the inter-character time must be  $\leq 3$  silences.

This means the time for 3 characters to be emitted so that the message is processed by the COUNTIS E43/44.

In order to use the information correctly, you must use the Modbus functions in accordance with the codes:

- 3: to read n words (maximum 128).
- 6: to write one word.
- 16: to write n words (maximum 128).

N.B.:

1 word  $\Leftrightarrow$  2 bytes  $\Leftrightarrow$  16 bits

2 words  $\Leftrightarrow$  4 bytes  $\Leftrightarrow$  32 bits

The broadcast communication is available for the log that stores the tariff.

### 8.4. Communication tables

The communication tables and relevant notes are available on the COUNTIS E43/E44 documentation page on the website at the following address:

[www.socomec.com/en/countis-e4x](http://www.socomec.com/en/countis-e4x)



# 9. CONFIGURATION

The device can be configured directly from the COUNTIS E43/E44 screen in programming mode or via the communication link. The paragraphs below describe configuring using the screen.

## 9.1. Onscreen configuration

From the screen, go to programming mode to change your communication settings. How to browse through the programming mode is described in the following stages:

FUNCTION	WHERE	BUTTONS	PRESS
Switch menus	Every page with the exception of SETUP 1/2		Realtime
Switch pages within a menu	Every page within a menu		Realtime
Go to menu SETUP 2	Menu page SETUP		> 3 sec
Go to menu SETUP 1	Every page with the exception of SETUP 1	SET	> 3 sec
Change a value/digit	Pages SETUP 1/2		Realtime
Confirm a value/digit	Pages SETUP 1/2		Realtime
Exit menu SETUP 1/2	Menu SETUP 1/2		> 3 sec
Start/stop the displayed partial meter	Partial meter menu	+	Realtime
Reset the displayed partial meter to zero	Partial meter menu	+	> 3 sec
Display test	Every page with the exception of SETUP 1/2	+	> 10 sec

### 9.1.1. Detailed view of menu "SETUP 1"

You can change the current tariff either via the communication link or via the device's T1/2 inputs.

In the "SETUP 1" menu you can select the tariff management mode.

Press SET for 3 seconds using a screwdriver to put the device into programming mode.

Press to go to the two programming options: COM = Modbus connection or DiG = T1/T2 inputs

SET >3s

▼ **Tariff management selections**

x1

▼ x1 **Confirm**

COM = Modbus communication  
DiG = T1/T2 inputs

▼ >3s **Exit menu**

Y=Save changes and exit  
 N=Exit without saving  
 C=Continue without saving

x1 **Confirm**

### 9.1.2. View all of the menu "SETUP 2"

In the SETUP 2 menu, press "" for 3 seconds to put the device into programming mode.

You can go to the different screens by pressing "":

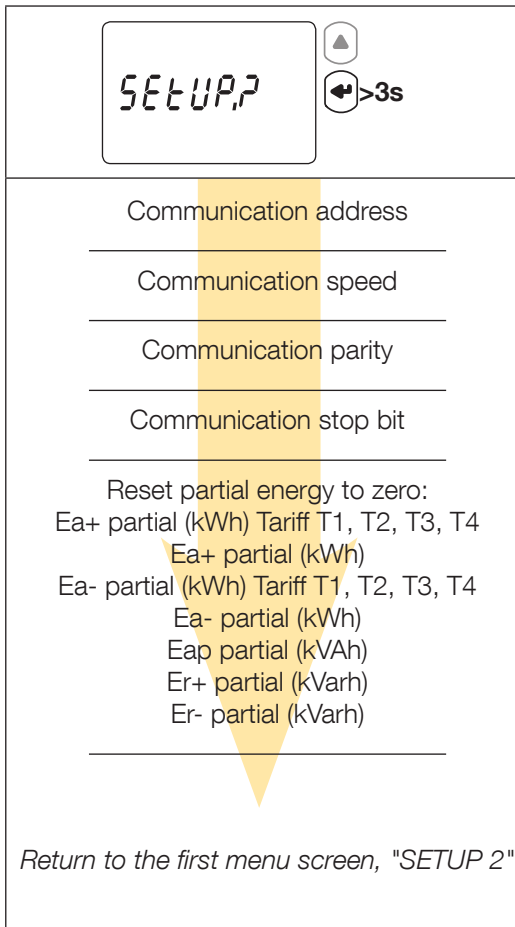

### 9.1.3. Detailed view of menu "SETUP 2"

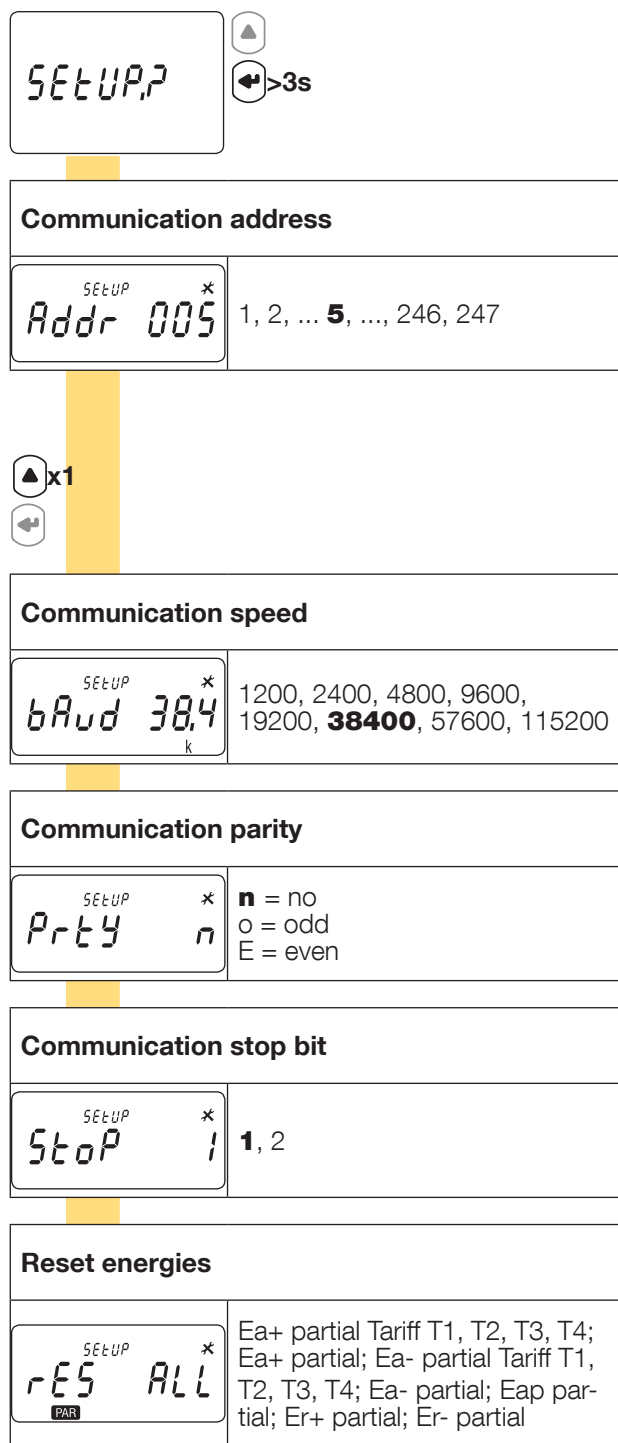

Return to the first menu screen, "SETUP 2"

**XX** = default value





### 9.1.4. Example: setting the communication address

In "SETUP 2" mode (see page 14), go to the "Addr communication address" screen

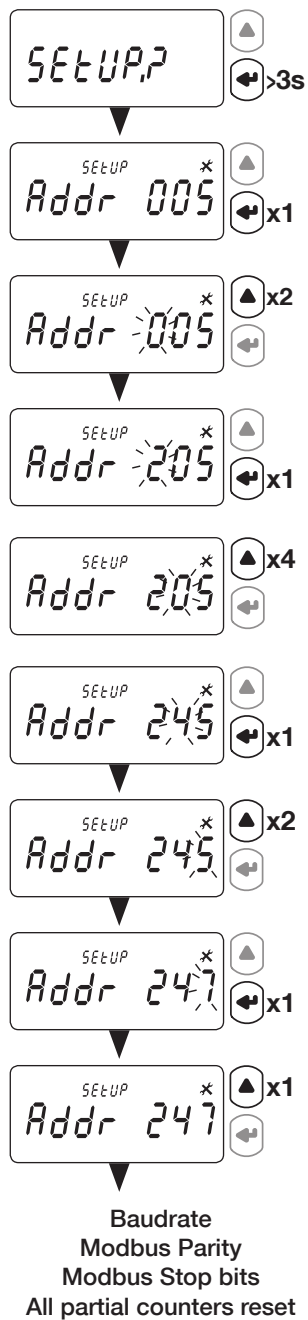
Example: changing the communication address to 247.



# 10. USE

Switch menus by pressing "". Press "" to see the electrical readings or information within a menu.

The menus and related measurements are described in the table below:

Tariff 1 (Tar.1)	Tariff 2 (Tar.2)	Tariff 3 (Tar.3)	Tariff 4 (Tar.4)	Total (tot)	Partial readings and energy balance (Par.b)	Realtime values (rt)	Information (inFo)
Tariff 1 - Imported and exported active energy	Tariff 2 - Imported and exported active energy	Tariff 3 - Imported and exported active energy	Tariff 4 - Imported and exported active energy	Total imported and exported active energy	Partial imported active energy by tariff	Active, apparent and reactive power	Metrological firmware version
Tariff 1 - Imported and exported inductive reactive energy	Tariff 2 - Imported and exported inductive reactive energy	Tariff 3 - Imported and exported inductive reactive energy	Tariff 4 - Imported and exported inductive reactive energy	Total apparent energy	Partial imported active energy	Phase/phase and phase/neutral voltage	Non-metrological firmware version
Tariff 1 - Imported and exported capacitive reactive energy	Tariff 2 - Imported and exported capacitive reactive energy	Tariff 3 - Imported and exported capacitive reactive energy	Tariff 4 - Imported and exported capacitive reactive energy	Total imported and exported inductive reactive energy	Partial exported active energy by tariff	Three-phase current	Checksum of metrological firmware
Tariff 1 - Imported and exported reactive energy	Tariff 2 - Imported and exported reactive energy	Tariff 3 - Imported and exported reactive energy	Tariff 4 - Imported and exported reactive energy	Total imported and exported capacitive reactive energy	Partial exported active energy	Power factor	Checksum of non-metrological firmware
Go back to first screen, menu "Tar.1"	Go back to first screen, menu "Tar.2"	Go back to first screen, menu "Tar.3"	Go back to first screen, menu "Tar.4"	Total imported and exported reactive energy	Partial apparent energy	Frequency	Connection type
				Go back to first screen, menu "tot"	Partial imported and exported reactive energy	Go back to first screen, menu "rt"	Go back to first screen, menu "info"
					Active energy balance		
					Reactive energy balance		
					Go back to first screen, menu "Par.b"		

## 10.1. Detailed view of the menu for tariff 1, "Tar.1"

**Imported active energy, tariff 1**

$\sum_{t \in R_{r,1}}$ 000006.22 kWh	
--	--

**Exported active energy, tariff 1**

$\sum_{t \in R_{r,1}}$ 000006.22 kWh	
--	--

**Imported inductive reactive energy, tariff 1**

$\sum_{t \in R_{r,1}}$ 000006.22 kvarh	
--	--

**Exported inductive reactive energy, tariff 1**

$\sum_{t \in R_{r,1}}$ 000006.22 kvarh	
--	--

**Imported capacitive reactive energy, tariff 1**

$\sum_{t \in R_{r,1}}$ 000006.22 kvarh	
--	--

**Exported capacitive reactive energy, tariff 1**

$\sum_{t \in R_{r,1}}$ 000006.22 kvarh	
--	--

**Imported reactive energy, tariff 1**

$\sum_{t \in R_{r,1}}$ 000006.22 kvarh	
--	--

**Exported reactive energy, tariff 1**

$\sum_{t \in R_{r,1}}$ 000006.22 kvarh	
--	--

Go back to first screen, menu "Tar.1"

## 10.2. Detailed view of the menu for tariff 2, "Tar.2"

**Imported active energy, tariff 2**

$\sum_{\text{Tar.2}}$ 000006.22 kWh	
---	--

**Exported active energy, tariff 2**

$\sum_{\text{Tar.2}}$ 000006.22 kWh	
---	--

**Imported inductive reactive energy, tariff 2**

$\sum_{\text{Tar.2}}$ 000006.22 kvarh	
---	--

**Exported inductive reactive energy, tariff 2**

$\sum_{\text{Tar.2}}$ 000006.22 kvarh	
---	--

**Imported capacitive reactive energy, tariff 2**

$\sum_{\text{Tar.2}}$ 000006.22 kvarh	
---	--

**Exported capacitive reactive energy, tariff 2**

$\sum_{\text{Tar.2}}$ 000006.22 kvarh	
---	--

**Imported reactive energy, tariff 2**

$\sum_{\text{Tar.2}}$ 000006.22 kvarh	
---	--

**Exported reactive energy, tariff 2**

$\sum_{\text{Tar.2}}$ 000006.22 kvarh	
---	--

Go back to first screen, menu "Tar.2"

## 10.3. Detailed view of the menu for tariff 3, "Tar.3"

<b>Imported active energy, tariff 3</b>	
$\sum$ 000006.22 kWh	

<b>Exported active energy, tariff 3</b>	
$\sum$ 000006.22 kWh	

<b>Imported inductive reactive energy, tariff 3</b>	
$\sum$ 000006.22 kvarh	

<b>Exported inductive reactive energy, tariff 3</b>	
$\sum$ 000006.22 kvarh	

<b>Imported capacitive reactive energy, tariff 3</b>	
$\sum$ 000006.22 kvarh	

<b>Exported capacitive reactive energy, tariff 3</b>	
$\sum$ 000006.22 kvarh	

<b>Imported reactive energy, tariff 3</b>	
$\sum$ 000006.22 kvarh	

<b>Exported reactive energy, tariff 3</b>	
$\sum$ 000006.22 kvarh	

Go back to first screen, menu "Tar.3"

## 10.4. Detailed view of the menu for tariff 4, "Tar.4"

<b>Imported active energy, tariff 4</b>	
$\sum$ ⤵ 000006.22 kWh	

<b>Exported active energy, tariff 4</b>	
$\sum$ ⤵ 000006.22 kWh	

<b>Imported inductive reactive energy, tariff 4</b>	
$\sum$ ⤵ 000006.22 kvarh	

<b>Exported inductive reactive energy, tariff 4</b>	
$\sum$ ⤵ 000006.22 kvarh	

<b>Imported capacitive reactive energy, tariff 4</b>	
$\sum$ ⤵ 000006.22 kvarh	

<b>Exported capacitive reactive energy, tariff 4</b>	
$\sum$ ⤵ 000006.22 kvarh	

<b>Imported reactive energy, tariff 4</b>	
$\sum$ ⤵ 000006.22 kvarh	

<b>Exported reactive energy, tariff 4</b>	
$\sum$ ⤵ 000006.22 kvarh	

Go back to first screen, menu "Tar.4"

## 10.5. Detailed view of the total menu, "tot"

<b>Total imported active energy</b>	
 $\overset{L1}{\text{tot}}$ 000008.32 kWh	L1, L2, L3, $\Sigma$

<b>Total exported active energy</b>	
 $\overset{L1}{\text{tot}}$ 000008.32 kWh	L1, L2, L3, $\Sigma$

<b>Total apparent energy</b>	
 $\overset{\text{tot}}{\Sigma}$ 000008.32 kVAh	$\Sigma$

<b>Total imported inductive reactive energy</b>	
 $\overset{\text{tot}}{\Sigma}$ 000008.32 kvarh	$\Sigma$

<b>Total exported inductive reactive energy</b>	
 $\overset{\text{tot}}{\Sigma}$ 000008.32 kvarh	$\Sigma$

<b>Total imported capacitive reactive energy</b>	
 $\overset{\text{tot}}{\Sigma}$ 000008.32 kvarh	$\Sigma$









<b>Total exported capacitive reactive energy</b>	
 $\overset{\text{tot}}{\Sigma}$ 000008.32 kvarh	$\Sigma$







<b>Total imported reactive energy</b>	
 $\overset{L1}{\text{tot}}$ 000008.32 kvarh	L1, L2, L3, $\Sigma$

<b>Total exported reactive energy</b>	
 $\overset{L1}{\text{tot}}$ 000008.32 kvarh	L1, L2, L3, $\Sigma$

Go back to first screen, menu "tot"

## 10.6. Detailed view of the menu showing partial readings and the energy balance "Par.b"

<b>Imported partial active energy for tariff T1</b>	
 $\Sigma$ $PAR_{r,b}$ <b>000008.54</b> $\Sigma$ <small>PAR kWh</small>	
<b>Imported partial active energy for tariff T2</b>	
 $\Sigma$ $PAR_{r,b}$ <b>000008.54</b> $\Sigma$ <small>PAR kWh</small>	
<b>Imported partial active energy for tariff T3</b>	
 $\Sigma$ $PAR_{r,b}$ <b>000008.54</b> $\Sigma$ <small>PAR kWh</small>	
<b>Imported partial active energy for tariff T4</b>	
 $\Sigma$ $PAR_{r,b}$ <b>000008.54</b> $\Sigma$ <small>PAR kWh</small>	
<b>Partial imported active energy</b>	
 $\Sigma$ $PAR_{r,b}$ <b>000008.54</b> $\Sigma$ <small>PAR kWh</small>	
<b>Exported partial active energy for tariff T1</b>	
 $\Sigma$ $PAR_{r,b}$ <b>000008.54</b> $\Sigma$ <small>PAR kWh</small>	
<b>Exported partial active energy for tariff T2</b>	
 $\Sigma$ $PAR_{r,b}$ <b>000008.54</b> $\Sigma$ <small>PAR kWh</small>	
<b>Exported partial active energy for tariff T3</b>	
 $\Sigma$ $PAR_{r,b}$ <b>000008.54</b> $\Sigma$ <small>PAR kWh</small>	

<b>Exported partial active energy for tariff T4</b>	
 $\Sigma$ $PAR_{r,b}$ <b>000008.54</b> $\Sigma$ <small>PAR kWh</small>	
<b>Partial exported active energy</b>	
 $\Sigma$ $PAR_{r,b}$ <b>000008.54</b> $\Sigma$ <small>PAR kWh</small>	
<b>Partial apparent energy</b>	
 $\Sigma$ $PAR_{r,b}$ <b>000008.54</b> $\Sigma$ <small>PAR kVAh</small>	
<b>Partial imported reactive energy</b>	
 $\Sigma$ $PAR_{r,b}$ <b>000008.54</b> $\Sigma$ <small>PAR kvarh</small>	
<b>Partial exported reactive energy</b>	
 $\Sigma$ $PAR_{r,b}$ <b>000008.54</b> $\Sigma$ <small>PAR kvarh</small>	
<b>Active energy balance)</b>	
 $\Sigma$ $PAR_{r,b}$ <b>000008.54</b> <small>BAL kWh</small>	
<b>Reactive energy balance</b>	
 $L1$ $PAR_{r,b}$ <b>000008.32</b> <small>PAR kvarh</small>	

Go back to first screen, menu "Par.b"



### 10.6.1. Starting up the partial energy meter

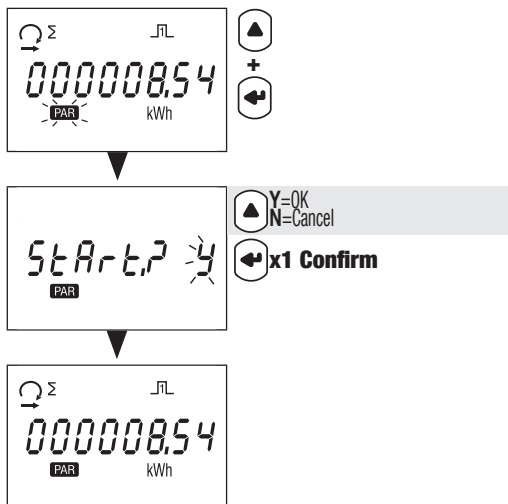

### 10.6.2. Stopping the partial energy meter

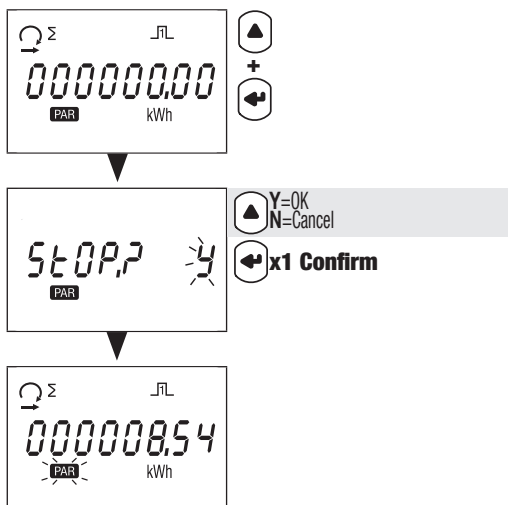

### 10.6.3. Resetting the partial energy meter to zero

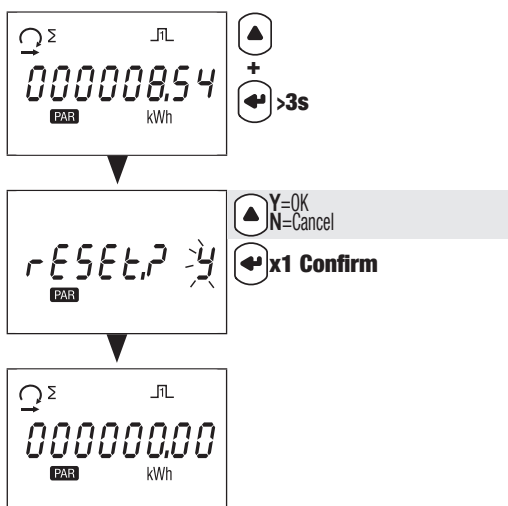

## 10.7. Detailed view of the menu for realtime readings, "rt"

Realtime active power	
$\text{L1}_{rt}$ 1150 kW	L1, L2, L3, $\Sigma$

Realtime apparent power	
$\text{L1}_{rt}$ 1150 kVA	L1, L2, L3, $\Sigma$

Realtime reactive power	
$\text{L1}_{rt}$ 1150 kvar	L1, L2, L3, $\Sigma$

Realtime phase/phase voltage	
$\Sigma \text{L12 23 31}_{rt}$ 1513 V	$\Sigma$

Realtime phase/neutral voltage	
$\Sigma \text{L1 2 3}_{rt}$ 075,7 V	$\Sigma$

Realtime three-phase current	
$\Sigma_{rt}$ 69,67 A	$\Sigma$

Realtime power factor	
$\Sigma_{rt}$ 0,800 PF	$\Sigma$

Frequency	
$\Sigma_{rt}$ 5000 Hz	

Go back to first screen, menu "rt"

## 10.8. Detailed view of the menu "info"

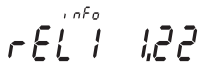
Metrological firmware version	
	

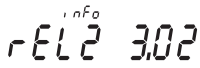
Non-metrological firmware version	
	

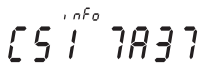
Checksum of metrological firmware	
	

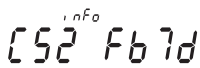
Checksum of non-metrological firmware	
	

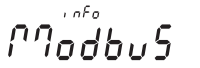
Installed communication port	
	

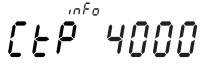
CT primary value (CtP)	
	1...12000 A

Full scale value (FSA)	
	1 or 5 A

Go back to first screen, menu "info"



# 11. DIAGNOSTICS MESSAGES

The following messages appear if there are connection or malfunction errors.



## 11.1. Missing phases



- If one or several phases are not detected, the exclamation point  flashes on the screen. Example: phase not detected

## 11.2. Reversed phases



- If a 123 phase sequence is detected, the  symbol appears.
- If a 132 phase sequence is detected, the  symbol appears.

## 11.3. Malfunction



- If you see this message, the meter has malfunctioned and must be replaced.

## 12. ASSISTANCE

<b>Causes</b>	<b>Solutions</b>
Device not working	Check the neutral and phase 1 cable connections.
Phases not shown onscreen	Check the connections
Phases reversed onscreen	Check the network configuration
Error message	Check the meter is working OK

# 13. CHARACTERISTICS

GENERAL FEATURES	
Compliant with	European EMC Directive No. 2014/30/EU dated 26/02/2014 LV Directive No. 2014/35/EU dated 26/02/2014 Measuring Instrument Directive MID No. 2014/32/EU dated 26/02/2014 EN50470-1/-3 IEC 62053-21/-23
Frequency	MID model: 50 Hz $\pm$ 1 Hz Non MID model: 50/60 Hz $\pm$ 1 Hz
Power supply	Self-supplied
Rated dissipated power (Wmax.)	7.5VA (0.5W)
OPERATING FEATURES	
Three-phase connectivity	4 wires MID model: 3x 230/400 V Non MID model: 3x 230/400 V to 3x 240/415 V
Stores energy readings and settings	In FRAM memory
Identifies display of tariffs	T1, T2, T3 and T4
CURRENT MEASUREMENTS	
Type	via current transformers
CT burden (for each phase)	0,04 VA
Startup current (Ist)	2mA (Class 1) 1mA (Class C)
Minimum current (Imin)	0.10 A
Transition current (Itr)	50mA
Reference current (Iref)	1 A
Maximum current (Imax)	6 A
CURRENT TRANSFORMER AND FSA	
Minimum CT ratio	1
Maximum CT ratio	12000
FSA programmable	1 or 5 A
OVERLOAD CAPACITY	
Voltage Un continuous	288 VAC
Voltage Un momentary (1 s)	300 VAC
Current Imax continuous	6 A
Current Imax momentary	20 Imax for 0.5 s
VOLTAGE MEASUREMENTS	
Consumption	3.5VA max. per phase
Permanent max. voltage	290V phase-neutral / 500V phase-phase
FREQUENCY MEASUREMENT	
Frequency measurement	45-65 Hz
ENERGY MEASUREMENT	
Active	Yes
Reactive	Yes
Total and partial reading	Yes
MID metering	Bidirectional with three-phase
Resolution	10 Wh, 10 varh

<b>ENERGY ACCURACY</b>	
Active energy Ea+	Class C (EN 50470-3) Class 1 (EN 62053-21)
Reactive energy Er+	Class 2 (EN 62053-23)
<b>TARIFF for Ea+</b>	
Tariff management	Yes (via input and communication)
Number of tariffs managed	2 (via input), 4 (via communication)
Tariff input	Yes
Input type	Opto-isolated
Voltage	0V --> Tariff 1 80-276 VAC-DC --> Tariff 2
<b>METROLOGICAL LED (Ea+, Ea-)</b>	
Pulse value	1000 pulses / kWh
Colour	Red
<b>PULSE OUTPUT</b>	
Type	Opto-isolated - 5 ... 27VDC 27mA according to EN 62053-31
Pulse weight according to the set CT ratio	1 Wh à CT -> 1 ... 4 5 Wh à CT -> 5 ... 24 25 Wh à CT -> 25 ... 124 125 Wh à CT -> 125 ... 624 1000 Wh à CT -> 625 ... 3124 10000 Wh à CT -> 3125 ... 12000
<b>DISPLAY</b>	
Type	8-digit LCD with backlight
Refresh time	1 s
Backlight activation time	10 s
Active energy: 1 display, 8-digit	00000.000 kWh ... 999999.99 MWh
Reactive energy: 1 display, 8-digit	00000.000 kvarh ... 999999.99 Mvarh
Apparent energy: 1 display, 8-digit	00000.000 kVAh ... 999999.99 MVAh
Instantaneous active power: 1 display, 4-digit	0.000 kW ... 99.99 MW
Instantaneous reactive power: 1 display, 4-digit	0.000 kvar ... 99.99 Mvar
Instantaneous apparent power: 1 display, 4-digit	0.000 kVA ... 99.99 MVA
Instantaneous voltage: 1 display, 4-digit	000.0 ... 999.9 V
Instantaneous current: 1 display, 4-digit	0.000 ... 99.99 kA
Power factor: 1 display, 4-digit	0.000 ... 1.000
Frequency: 1 display, 4-digit	45.00-65.00 Hz
<b>COMMUNICATION</b>	
RS485	2 wires + shielding/ half duplex
Protocol	Modbus, RTU mode
Baudrate	1200 / 2400 / 4800 / 9600 / 19200 / 38400 / 57600 / 115200 bps
Insulation	SELV
RS485 Unity of Load	1/8
<b>SAVING</b>	
Energy registers	In FRAM memory

<b>ENVIRONMENTAL CONDITIONS</b>	
Mechanical environment	M1
Electromagnetic environment	E2
Operating temperature range	-25° C to +55° C
Storage temperature	-25° C to +75° C
Humidity	≤ 80%
Installation	Internal (box/cabinet)
Vibrations	±0.075 mm
<b>HOUSING</b>	
Dimensions W x H x D (mm)	Modular - width of 4 modules (DIN 43880) 72 x 90 x 64
Mounting	On DIN rail (EN 60715)
Connection capacity, tightening torque	See chapter "6. Connection", page 10
Protection index	Front: IP51 - casing: IP20
Insulation class	Class II (EN 50470-1)
Weight	440 g



## 14. GLOSSARY OF ABBREVIATIONS

info	Menu information
rEL1	Metrological firmware version
rEL2	Non-metrological firmware version
CS1	Checksum of metrological firmware
CS2	Checksum of non-metrological firmware
tAr.1	Menu for Tariff 1
tAr.2	Menu for Tariff 2
tAr.3	Menu for Tariff 3
tAr.4	Menu for Tariff 4
tot	Total menu
PAr.b	Partial readings and energy balance menu
rt	Realtime values menu
SEtuP.2	Setup 2 menu
Addr	Slave address
bAud	Communication speed in bauds (bits per second)
Prty	Communication frame parity
n	No parity
o	Off parity
E	Even parity
StoP	Frame stop bit
1	1 stop bit
2	2 stop bits
rES	Reset partial energy
ConF?	Confirm selection
Y	Save and exit
N	Exit without saving
C	Continue without saving
tAr	Tariff management option
COM	Tariff management via communication
diG	Tariff management via device input

---

CORPORATE HQ CONTACT:  
SOCOMECSAS  
1-4 RUE DE WESTHOUSE  
67235 BENFELD, FRANCE

---

[www.socomec.com](http://www.socomec.com)

