

MODULAR CIRCUIT BREAKERS FOR CIRCUIT PROTECTION

MCB - MTC - MT - MTHP

Technical data

TYPE		MTC			MT		
		MTC45	MTC60	MTC100	MT 45	MT 60	
Rated current (In)	(A)	2-32	6-32	6-32	6-40	1-63	
Utilization category		A	A	A	A	A	
Rated operational voltage (Ue)	(V)	230/400 - 240/415	230/400 - 240/415	230 - 240	230/400 - 240/415	230/400 - 240/415	
Minimum operating voltage (Ue min)	(V)	12 AC/DC	12 AC/DC	12 AC/DC	12 AC/DC	12 AC/DC	
Maximum operating voltage (Ue max)	(V)	440 AC/ 220 DC	440 AC/ 220 DC	253 AC/ 110 DC	440 AC/ 220 DC	440 AC/ 220 DC	
Insulation voltage (Ui)	(V)	500	500	500	500	500	
Rated frequency	(Hz)	50 / 60	50 / 60	50 / 60	50 / 60	50 / 60	
Rated impulse withstand voltage (Uimp)	(kV)	4	4	4	4	4	
Overvoltage category:		III	III	III	III	III	
Number of poles		1 1+N,2 3,4	1+N,2 3,4	1+N,2	1,1+N 2,3,4	1,1+N 2,3,4	
Energy limiting class (B and C curve):		3 3 3	3 3	3 3 (≤16A) 1 (>16A)	3 3	3 3	
Breaking capacity							
Alternating current	IEC/EN 60898-1	Icn (A)	4500	6000 ⁽¹⁾ 6000	10000 ⁽¹⁾	4500	6000
		Ics (A)	1 Icn	1 Icn	0.75 Icn	1 Icn	1 Icn
		Icu 230/240 V (kA)	4.5 6 6	7.5 7.5	10	4.5 6	10 20
	IEC/EN 60947-2	Icu 400/415 V (kA)	- - 4.5	- 6	-	- 6	- 10
		Ics (kA)	100% Icu	100% Icu	75% Icu	100% Icu	75% Icu
Direct current	IEC/EN 60947-2	Icu (1 pole) 50 V (kA)	6	10	-	6	10
		Ics (kA)	6	10	-	6	10
		Icu (2 poles in series) 110 V (kA)	6	10	10 (15 at 50V)	6	10
		Ics (kA)	6	10	10 (15 at 50V)	6	6
		Icu (4 poles in series) 220 V (kA)	4.5	6	-	4.5	10
		Ics (kA)	4.5	6	-	4.5	10
Wiring		cable section (mm²)	rigid	≤ 1x16 - ≤ 1x10+1x6	≤ 1x16 - ≤ 1x10+1x6	≤ 1x16 - ≤ 1x10+1x6	≤ 1x35 - ≤ 2x16 - ≤ 1x16+2x10
		flexible	≤ 1x10 - ≤ 2x6	≤ 1x10 - ≤ 2x6	≤ 1x10 - ≤ 2x6	≤ 1x35 - ≤ 2x16 - ≤ 1x16+2x10	≤ 1x35 - ≤ 2x16 - ≤ 1x16+2x10
Screwdriver suggested:			PZ2	PZ2	PZ2	PZ2	PZ2
Electrical endurance:			10000	10000	10000	10000	10000
Mechanical endurance:			20000	20000	20000	20000	20000
Max. no. of usable modular accessories:			2	2	2	2	2
Upline/downline power supply:			yes	yes	yes	yes	yes
ON/OFF status displayed:			yes	yes	yes	yes	yes
Mounting position:			any	any	any	any	any
Type of residual current device:			-	-	-	Add-on RCD BD	Add-on RCD BD
Rated tightening torque:	(Nm)		1.2	1.2	1.2	2	2
Degree of protection:	terminals		IP20	IP20	IP20	IP20	IP20
	front		IP40	IP40	IP40	IP40	IP40
Pollution degree:			2	2	2	2	2
Tropicalization:			55°C - RH 95%	55°C - RH 95%	55°C - RH 95%	55°C - RH 95%	55°C - RH 95%
Reference temperature:	(°C)		30	30	30	30	30
Operating temperature:	(°C)		-25 +60	-25 +60	-25 +60	-25 +60	-25 +60
Stocking temperature:	(°C)		-40 +70	-40 +70	-40 +70	-40 +70	-40 +70
Double connection (cable+fork busbar)			no	no	no	yes (only downstream)	yes (only downstream)
Weight:	(g)		135 (per module)	135 (per module)	135 (per module)	145 (per pole)	145 (per pole)
Tripping characteristic			C	C B	C	C B	C B D
Rated currents available In:	(A)		-	-	-	-	1 - -
			2	-	-	-	2 - -
			-	-	-	-	3 - -
			-	-	-	-	4 - -
			6	6 6	6	6 6	6 6 6
			10	10 10	10	10 10	10 10 10
			13	13 13	13	13 13	13 13 13
			16	16 16	16	16 16	16 16 16
			20	20 20	20	20 20	20 20 20
			25	25 25	25	25 25	25 25 25
			32	32 32	32	32 32	32 32 32
			-	-	-	40 40	40 40 40
			-	-	-	-	50 50 -
			-	-	-	-	63 63 -
			-	-	-	-	- - -

⁽¹⁾ Breaking capacity of the single pole Icn=4500A

⁽²⁾ ≤95mm² with reduced connection terminal (width connection < 17mm)

MODULAR CIRCUIT BREAKERS FOR CIRCUIT PROTECTION

MT												MTHP														
MT 100						MT 250						MTHP 160				MTHP 250										
1-25			32-63			6-20			25			32-40			50-63				63-125				20-63			
A						A						A						A				A				
230/400 - 240/415			230/400 - 240/415			230/400 - 240/415			230/400 - 240/415			230/400 - 240/415			230/400 - 240/415				230/400				230/400			
12 AC/DC			12 AC/DC			12 AC/DC			12 AC/DC			12 AC/DC			12 AC/DC				12 AC/DC				12 AC/DC			
440 AC/220 DC			440 AC/220 DC			440 AC/220 DC			440 AC/220 DC			440 AC/220 DC			440 AC/220 DC				440 AC/220 DC				440 AC/220 DC			
500			500			500			500			500			500				500				500			
50/60			50/60			50/60			50/60			50/60			50/60				50/60				50/60			
4			4			4			4			4			4				6				6			
III			III			III			III			III			III				IV				IV			
1	2	3,4	1	2	3,4	1	2	3,4	1	2	3,4	1	2	3,4	1	2	3,4	1	2,3,4	1	2	3,4	1	2	3,4	
3	3	3	3	3	3	-	-	-	-	-	-	-	-	-	-	-	-	-	-	-	-	-	-	-	-	-
10000			10000			25000			20000			15000			12500				10000				25000			
0.75 Icn			0.75 Icn			0.75 Icn			0.75 Icn			0.75 Icn			0.75 Icn				0.75 Icn				0.75 Icn			
15	30	25	12.5	25	20	25	50	40	20	40	30	15	30	25	15	25	20	16	20	6	25	25	25	50	30	
-	20	15	-	15	12.5	-	30	25	-	25	20	-	20	15	-	15	15	4.5	16	6	25	25	6	25	25	
50% Icu			50% Icu			50% Icu			50% Icu			50% Icu			50% Icu				75% Icu							
10			10			20			20			20			20				25							
10			10			15			15			15			15				20							
15			15			25			25			25			25				30							
15			15			20			20			20			20				25							
15			15			25			25			25			25				25							
12			12			20			20			20			20				20							
1x35 - . 2x16 - . 1x16+2x10			≤ 1x35 - ≤ 2x16 - ≤ 1x16+2x10			≤ 1x35 - ≤ 2x16 - ≤ 1x16+2x10			≤ 1x35 - ≤ 2x16 - ≤ 1x16+2x10			≤ 1x35 - ≤ 2x16 - ≤ 1x16+2x10			≤ 1x35 - ≤ 2x16 - ≤ 1x16+2x10				≤ 1x70 - ≤ 2x25 - ≤ 2x25+1x10				≤ 1x70 - ≤ 2x25 - ≤ 2x25+1x10			
1x35 - . 2x16 - . 1x16+2x10			≤ 1x35 - ≤ 2x16 - ≤ 1x16+2x10			≤ 1x35 - ≤ 2x16 - ≤ 1x16+2x10			≤ 1x35 - ≤ 2x16 - ≤ 1x16+2x10			≤ 1x35 - ≤ 2x16 - ≤ 1x16+2x10			≤ 1x35 - ≤ 2x16 - ≤ 1x16+2x10				≤ 1x50 ⁽²⁾ - ≤ 2x25 - ≤ 3x16				≤ 1x50 ⁽²⁾ - ≤ 2x25 - ≤ 3x16			
PZ2			PZ2			PZ2			PZ2			PZ2			PZ2				PZ2							
10000			10000			10000			10000			10000			10000				10000							
20000			20000			20000			20000			20000			20000				20000							
2			2			2			2			2			2				2							
yes			yes			yes			yes			yes			yes				yes							
yes			yes			yes			yes			yes			yes				yes							
any			any			any			any			any			any				any							
Add-on RCD BD			Add-on RCD BD			Add-on RCD BD			Add-on RCD BD			Add-on RCD BD			Add-on RCD BD				Add-on RCD BDHP							
2			2			2			2			2			2				3.5 / 3 (terminal)							
IP20			IP20			IP20			IP20			IP20			IP20				IP20							
IP40			IP40			IP40			IP40			IP40			IP40				IP40							
2			2			2			2			2			2				2							
55°C - RH 95%			55°C - RH 95%			55°C - RH 95%			55°C - RH 95%			55°C - RH 95%			55°C - RH 95%				55°C - RH 95%							
30			30			30			30			30			30				30							
-25 +60			-25 +60			-25 +60			-25 +60			-25 +60			-25 +60				-25 +60							
-40 +70			-40 +70			-40 +70			-40 +70			-40 +70			-40 +70				-40 +70							
yes (only downstream)			yes (only downstream)			yes (only downstream)			yes (only downstream)			yes (only downstream)			yes (only downstream)				no							
145 (per pole)			145 (per pole)			145 (per pole)			145 (per pole)			145 (per pole)			145 (per pole)				250 (per pole)							
C			B			D			C			C			C				D							
-			-			1			-			-			-				-							
-			-			2			-			-			-				-							
-			-			3			-			-			-				-							
-			-			4			-			-			-				-							
6			6			6			6			6			6				6							
10			10			10			10			10			10				10							
13			13			13			13			13			13				13							
16			16			16			16			16			16				16							
20			20			20			20			20			20				20							
25			25			25			25			25			25				25							
32			32			32			32			32			32				32							
40			40			40			40			40			40				40							
50			50			-			50			50			-				50							
63			63			-			63			63			-				63							
-			-			-			-			-			80				80							
-			-			-			-			-			100				100							
-			-			-			-			-			125				-							

For technical information contact the Technical Assistance Service or visit gewiss.com

CHARACTERISTICS OF THE NEW KINEMATIC MECHANISM OF THE MTC COMPACT CIRCUIT BREAKERS

The position of the releases on the front, with magnetic turns and opposing arc chute chambers, allows a notable reduction in arc time and short-circuit strain on the mechanism. It has therefore been possible to halve the system and lighten the mechanism, which has short pre-arc times thanks to the reduced energy. The new mechanism has been sized and optimised by means of a sophisticated planning, engineering and testing programme.

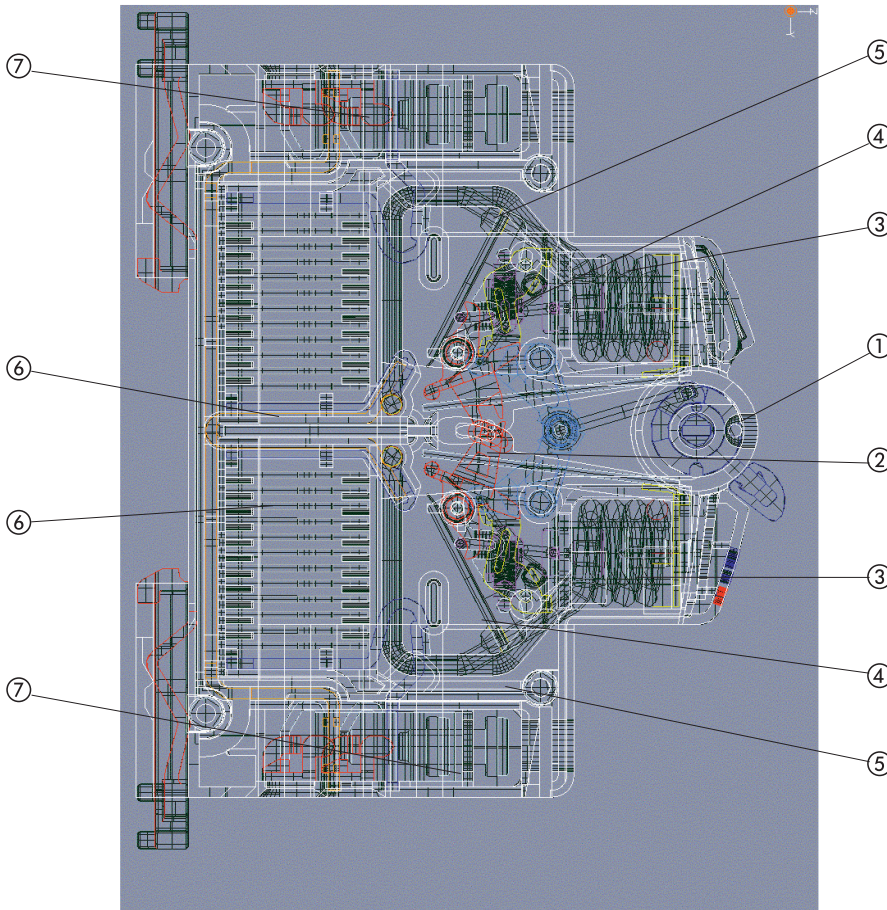

- ① Manual control lever with a position coherent with the contacts, allowing the circuit breaker to be used as a switch disconnecter (in compliance with Standard CEI 64-8)
- ② Toggle joint tripping mechanism with tripping accelerator for short-circuit condition
- ③ Electromagnets for instantaneous short-circuit tripping
- ④ Silver-graphite contacts to maintain electrical characteristics over time
- ⑤ Magnetic turns in the arc chute chambers
Arc chute chambers with 12 reeds in a ferromagnetic material
- ⑥ Shell-type terminals with anti-loosening
- ⑦ tightening system

MODULAR CIRCUIT BREAKERS FOR CIRCUIT PROTECTION

POWER LOSS VALUES AND TEMPERATURE PERFORMANCE

MTC 45 - 60 - 100 Compact miniature circuit breakers

General characteristics

The MTC compact miniature circuit breakers are characterised by the reduced overall dimensions they occupy in the board, and their full modularity with electrical auxiliaries and modular accessories. It is therefore possible to position all the equipment necessary to protect and control the service electrical system centrally, in small spaces. The innovations are based on a new kinematic mechanism for activating the circuit breaker (with a world-wide Gewiss patent) which helps to increase normal performance while reducing the occupied overall dimensions by 50%. This new device makes it possible to include a bipolar circuit breaker in a single 18mm module, with both poles protected by both magnetic and thermal release.

Temperature performance

In plant engineering situations where the ambient temperature is higher than the standard 30°C reference temperature, the circuit breakers may be subject to untimely tripping, i.e. inappropriate switch-off, because the rise in temperature is interpreted as overcurrent. In fact ambient temperature affects the initial deformation of the bimetal; at a temperature above 30°, the thermal release intervenes more quickly, acting like a relay with a lower rated current.

It is therefore imperative to take into consideration the temperature performance of the rated current if the circuit breaker is installed in a place with a temperature above 30°. The following tables show the max. operating currents corresponding to the different temperatures.

MTC 45 - 60 - 100 COMPACT MINIATURE CIRCUIT BREAKERS						
In (A)	Temperature					
	10°C	20°C	30°C	40°C	50°C	60°C
2	2.1	2.05	2	1.9	1.8	1.55
6	7.2	6.6	6	5.7	5.3	5
10	11.8	10.8	10	9.6	9.1	8.6
13	15	14	13	12.4	11.7	11
16	18.2	17.2	16	15.2	14.3	13.4
20	22.8	21.4	20	19.5	18.9	18.4
25	28.5	26.8	25	24	23	22
32	36.5	34.2	32	30.8	29.5	28

Power loss per pole

The following table shows the power loss values for the MTC miniature circuit breakers, so you can check the overtemperature values in the board in relation to Standards EN 60439 and CEI 17 - 43. You can also check whether the power loss of the devices is lower than - or equal to - the level that the enclosure is able to disperse, in accordance with Standards CEI 23 - 49 and CEI 23 - 51.

MTC 45 - 60 - 100 COMPACT MINIATURE CIRCUIT BREAKERS																
In (A)	2		6		10		13		16		20		25		32	
	Pole	N	Pole	N	Pole	N	Pole	N	Pole	N	Pole	N	Pole	N	Pole	N
R (mΩ)	450	1.07	29.4	2.6	20.3	2.6	14.2	2.6	8.7	2.6	5.7	2.6	5.3	2.6	3.4	2.6
P (W)	1.8	0.04	1.06	0.09	2.03	0.26	2.4	0.44	2.22	0.67	2.27	1.04	3.34	2	3.45	2.66

MODULAR CIRCUIT BREAKERS FOR CIRCUIT PROTECTION

POWER LOSS VALUES AND TEMPERATURE PERFORMANCE

MT 45 - MT 60 - MT 100 - MT 250 Miniature circuit breakers

General characteristics

Thanks to a wide range and excellent performance, the MT miniature circuit breakers allow the creation of electrical systems in which the use of MTCs alone would be insufficient.

The MT range, with rated current from 1 to 63A, characteristics B, C and D, and a breaking capacity of 6, 10 and 25 kA, satisfies all installation needs in the commercial, advanced commercial and industrial sectors. Thanks to the full modularity with the residual current devices, electrical auxiliaries and modular accessories, the MT range guarantees the optimum solution for every plant engineering context.

MT 45 - MT 60 - 100 - 250 TEMPERATURE PERFORMANCE						
In (A)	Temperature (°C)					
	15	20	30	40	50	60
1	1.07	1.04	1.00	0.97	0.93	0.90
2	2.14	2.07	2.00	1.93	1.86	1.79
3	3.21	3.11	3.00	2.90	2.79	2.69
4	4.28	4.14	4.00	3.86	3.72	3.58
6	7	6.67	6.00	5.52	4.84	3.96
10	11.2	10.8	10.0	8.9	7.95	7.16
13	14.4	13.9	13.0	11.9	10.9	10
16	17.6	17.1	16.0	14.9	13.9	12.8
20	22	21.3	20.0	17.8	16.1	15.1
25	28.2	27.1	25.0	23.4	21.3	18.8
32	37	35.3	32.0	30.8	27.8	23.1
40	45	43.3	40.0	34.8	30	28
50	57.5	55	50.0	46.7	42.1	36.3
63	70	67.7	63.0	59.9	52.7	41.25

MT 45 - MT 60 - 100 - 250 POWER LOSS PER POLE						
In (A)	Tripping characteristic					
	B		C		D	
	P (W)	R (mΩ)	P (W)	R (mΩ)	P (W)	R (mΩ)
1	-	-	2.20	2200	-	-
2	-	-	2.70	675	-	-
3	-	-	2.30	256	-	-
4	-	-	2.20	138	-	-
6	1.42	39	1.42	39	0.80	22
10	2.13	21	2.13	21	1.20	12
13	2.1	12.4	2.1	12.4	1.3	7.7
16	2.80	11	2.80	11	1.60	6.3
20	2.56	6.4	2.56	6.4	2.10	5.3
25	3.10	5	3.10	5	2.00	3.2
32	3.00	2.9	3.00	2.9	2.40	2.4
40	3.10	1.9	3.10	1.9	2.70	1.7
50	3.87	1.5	3.87	1.5	-	-
63	4.51	1.2	4.51	1.2	-	-

Note: power loss values are suitable also for neutral of 1P+N versions.

MTHP 160 - MTHP 250 High performance miniature circuit breakers

General characteristics

Thanks to a wide range and excellent performance, the MTHP miniature circuit breakers allow the creation of electrical systems in which the use of MTCs and MTs alone would be insufficient. The MTHP range, with rated current from 20 to 125A, characteristics C and D, and a breaking capacity of 10 and 25 kA, satisfies all installation needs in the commercial, advanced commercial and industrial sectors. Thanks to the full modularity with the residual current devices, electrical auxiliaries and modular accessories, the MTHP range guarantees the optimum solution for every plant engineering context.

MTHP 160 - 250 TEMPERATURE PERFORMANCE					
In (A)	Temperature				
	20°C	30°C	40°C	50°C	60°C
20	21	20	17.5	16	15
25	26	25	24	22	19
32	35	32	30	28	23
40	42	40	35	33	28
50	55	50	47	42	36
63	66	63	59	53	48
80	85	80	75	70	63
100	107	100	93	87	78
125	135	125	115	107	97

MTHP 160 - 250 POWER LOSS PER POLE									
In (A)	20	25	32	40	50	63	80	100	125
	Power loss (W)								
MTHP 250	2.8	2.7	3.1	3.5	4.2	5.6	-	-	-
MTHP 160	-	-	-	-	-	5.6	5.6	7.4	11

MODULAR CIRCUIT BREAKERS FOR CIRCUIT PROTECTION

TRIPPING CHARACTERISTICS IN ALTERNATING CURRENT (EN 60898)

MTC 45 - 60 - 100 Characteristic C
MT 45 - MT 60 - 100 - 250 Characteristic C
MTHP 160 - 250 Characteristic C

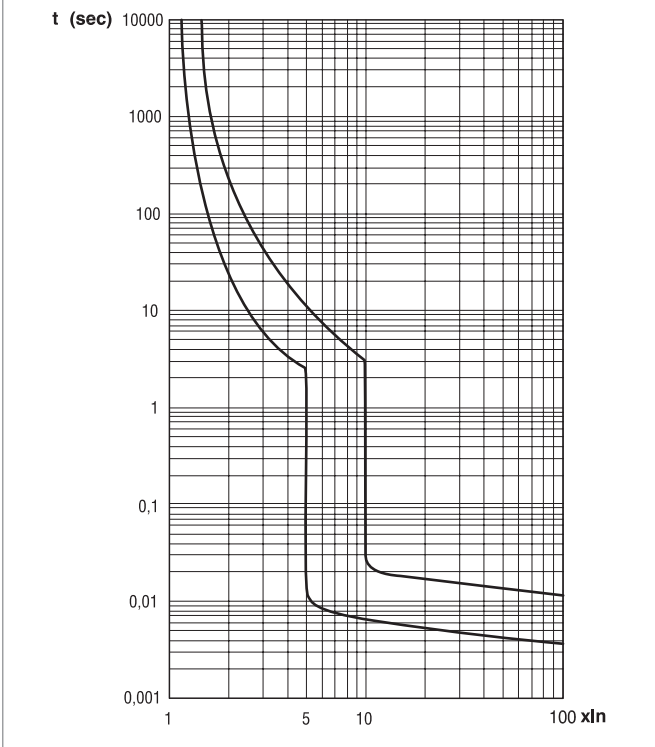

MT 45 - MT 60 - 100 Characteristic B
MTC 60 Characteristic B

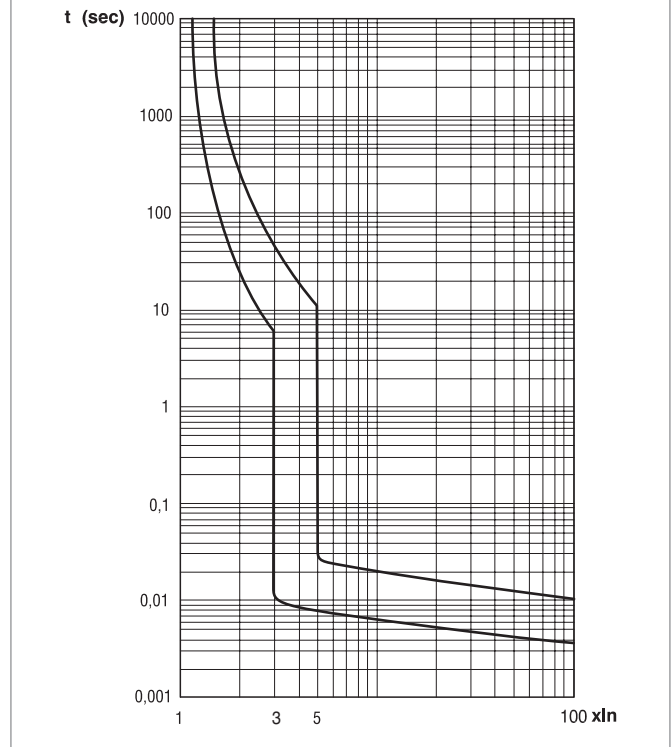

MT 60 - 100 Characteristic D
MTHP 160 Characteristic D

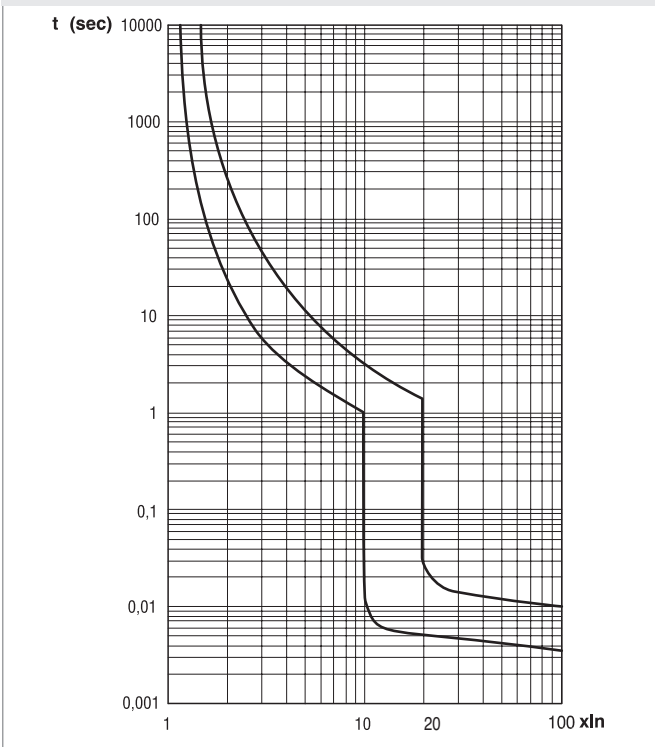

Tripping characteristic	B	C	D
In	from 6 to 63 A	from 1 to 125 A	from 6 to 100 A
Thermal release			
Inf	1,13 In	1,13 In	1,13 In
If	1,45 In	1,45 In	1,45 In
t	< 1 h	< 1 h	< 1 h
Magnetic release			
Inf	3 In	5 In	10 In
If	5 In	10 In	20 In
t	instantaneous	instantaneous	instantaneous

In = rated current
 Inf = conventional non-tripping current
 If = conventional tripping current
 t = tripping time

B tripping curve: tripping characteristic for the protection of electrical resistive loads (for example: heating) and very long electrical distribution lines.

C tripping curve: tripping characteristic for the protection of general electrical resistive or slight inductive loads (for example: fluorescent lamps).

D tripping curve: tripping characteristic for the protection of electrical heavy inductive loads or high starting currents (for example: electrical engines).

SPECIFIC LET-THROUGH ENERGY CHARACTERISTICS - MTC MODULAR COMPACT CIRCUIT BREAKERS

MTC 45 - 1P+N, 2P - 230V versions

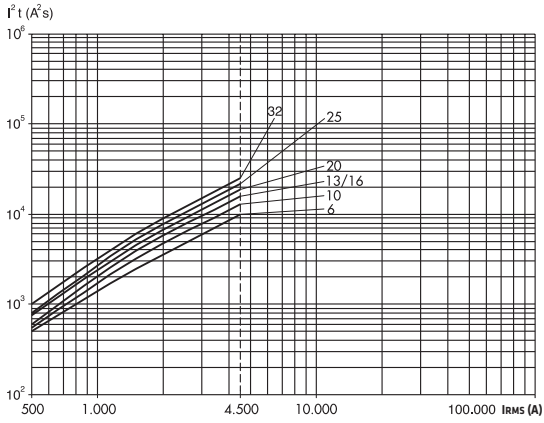

MTC 45 - 1P - 230V and 3P,4P - 230/400V versions

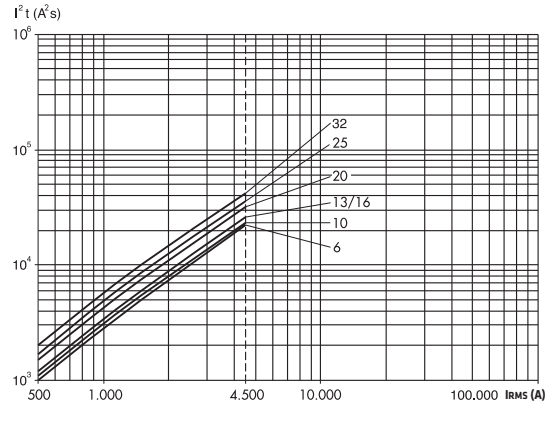

MTC 60 - 1P+N, 2P - 230V versions

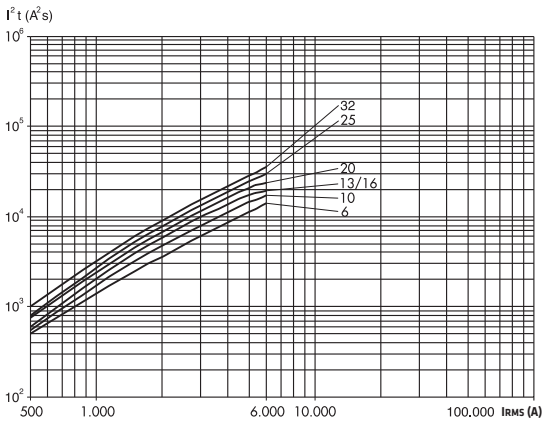

MTC 60 - 3P,4P - 230/400V versions

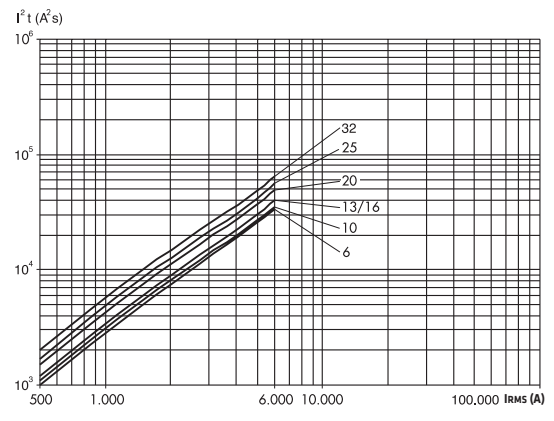

MTC 100 - 1P+N, 2P - 230V versions

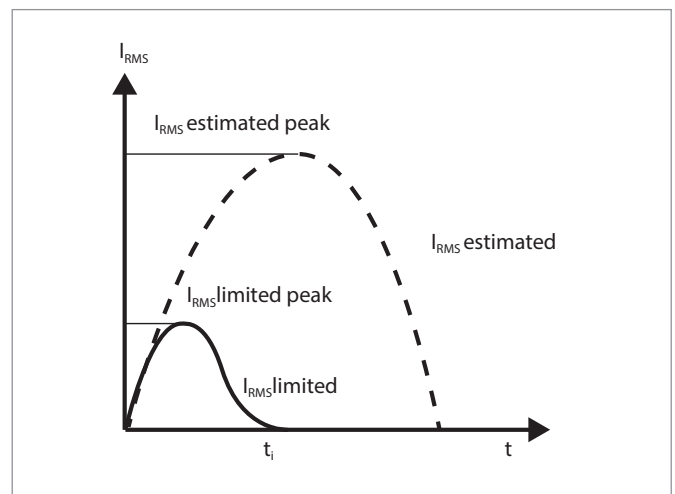
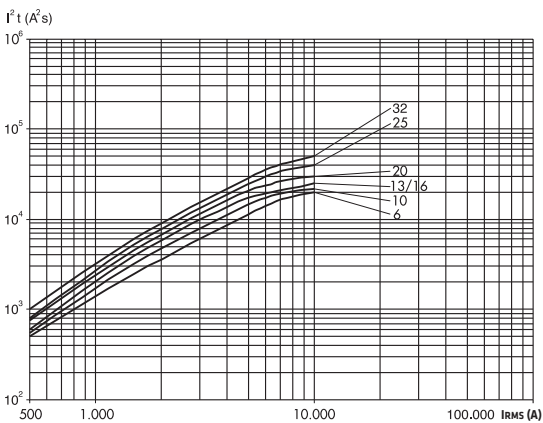

The curves above give the values of the specific let-through energy in relation to the short-circuit current expressed in A. Every curve refers to each rated current value of circuit breaker.

SPECIFIC LET-THROUGH ENERGY CHARACTERISTICS - MT 45 MODULAR CIRCUIT BREAKERS

MT 45 - 1P + N 2P 230V C characteristic

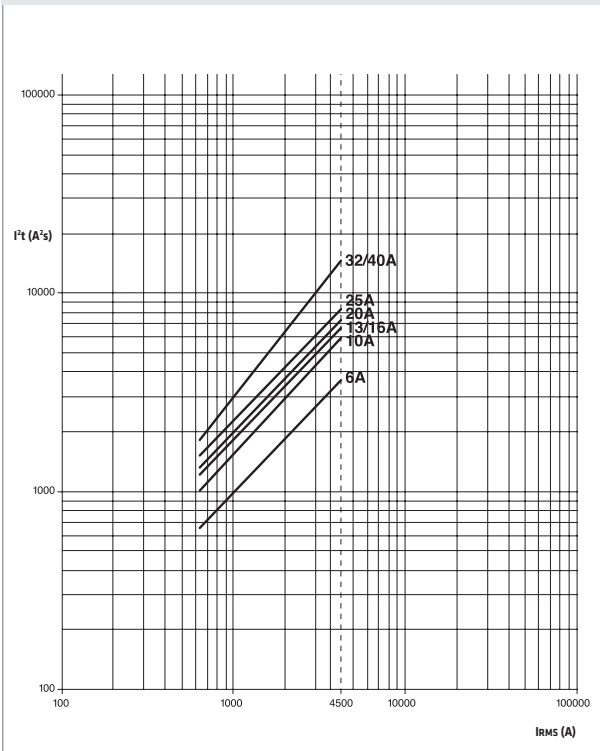

MT 45 - 2P 400V C characteristic

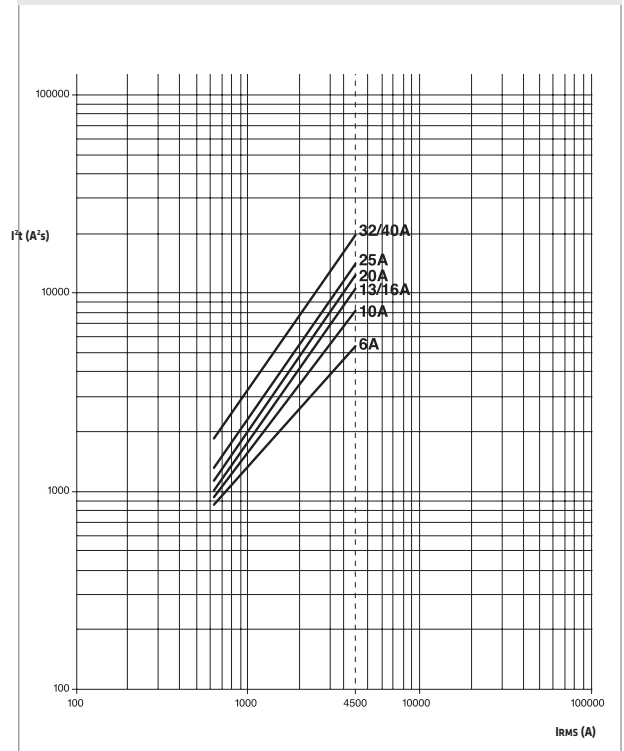

MT 45 - 1P - 230V 3P and 4P 400V C characteristic

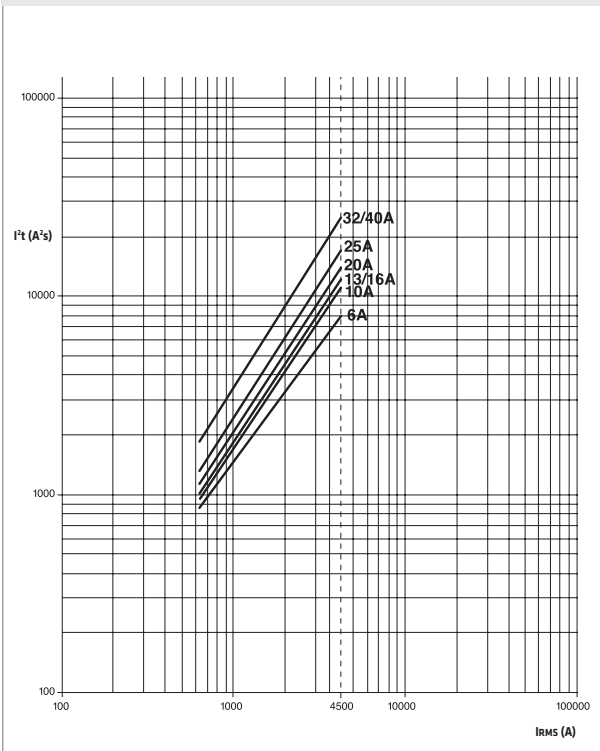

SPECIFIC LET-THROUGH ENERGY CHARACTERISTICS - MT 45 MODULAR CIRCUIT BREAKERS

MT 45 - 1P+N 2P 230V B characteristic

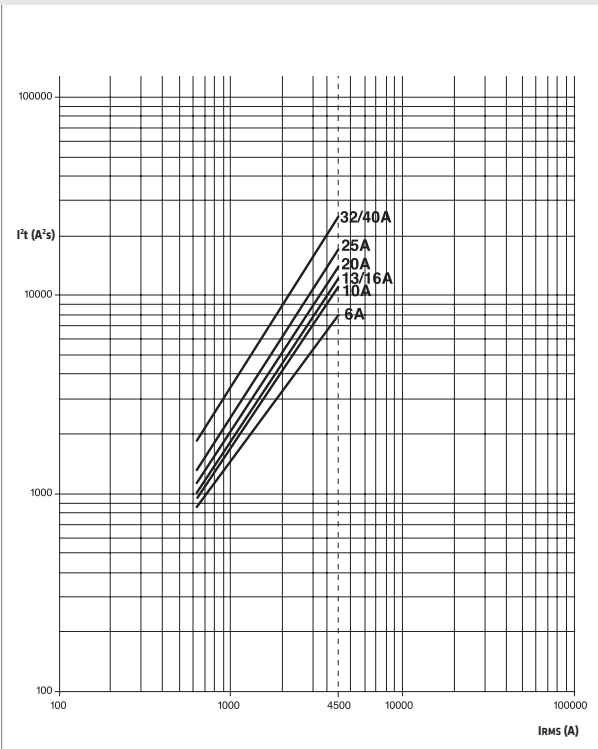

MT 45 - 2P 400V B characteristic

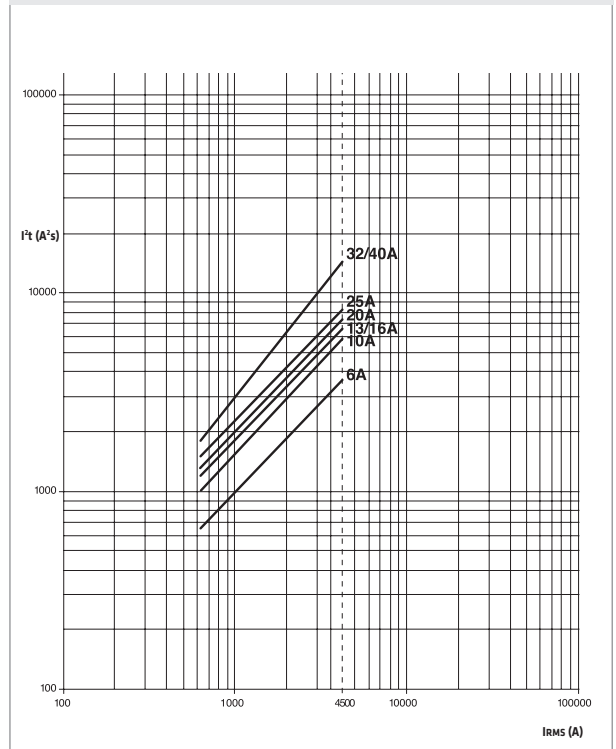

MT 45 - 1P - 230V 3P and 4P 400V B characteristic

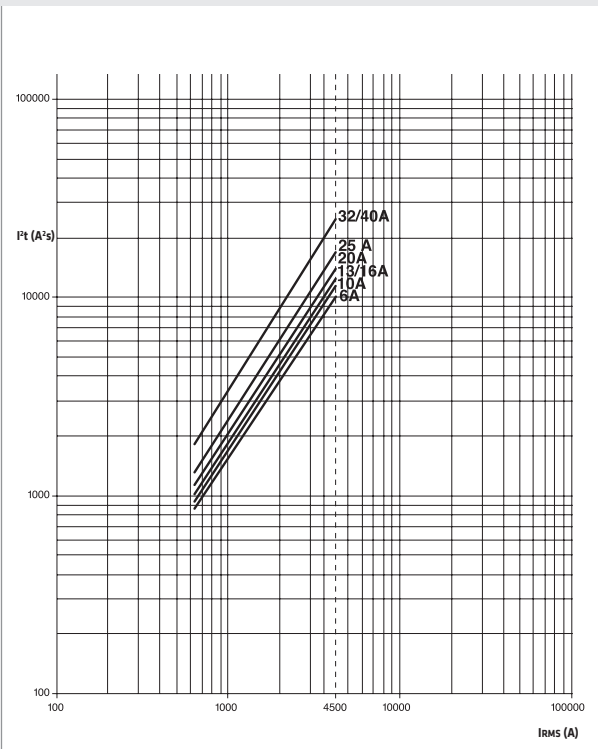

SPECIFIC LET-THROUGH ENERGY CHARACTERISTICS - MT 60 MODULAR CIRCUIT BREAKERS

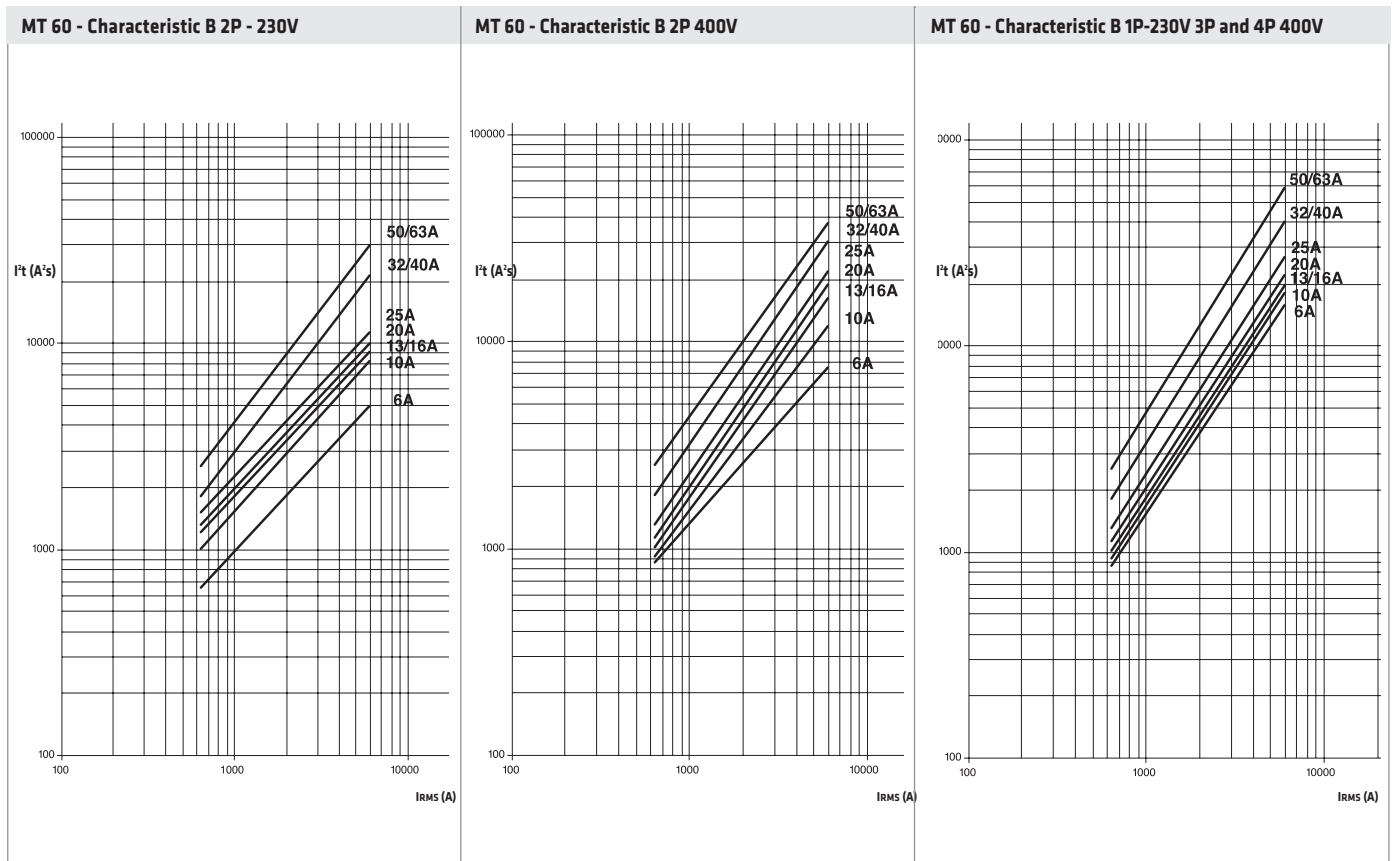
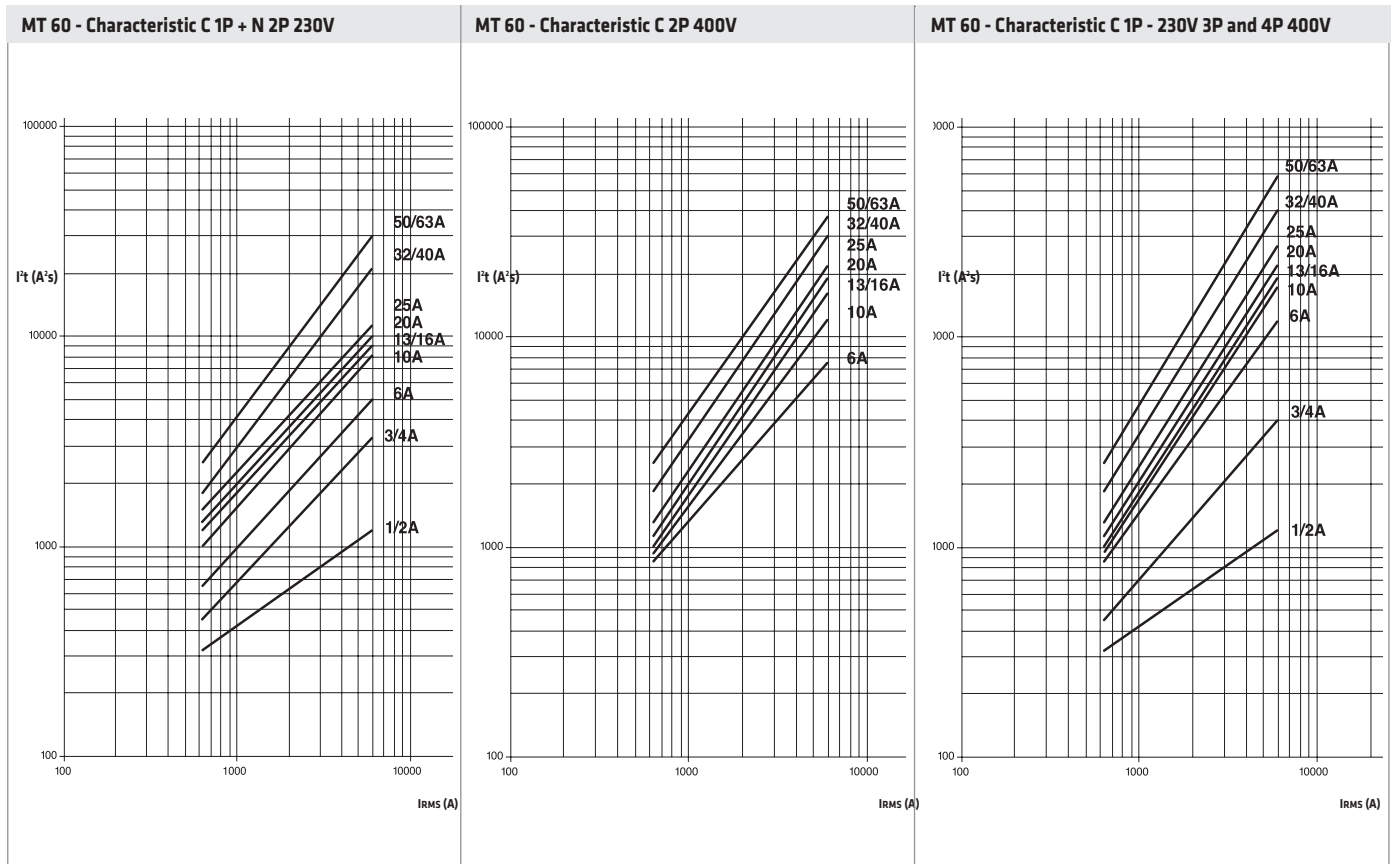

SPECIFIC LET-THROUGH ENERGY CHARACTERISTICS - MT 60 - MT 100 MODULAR CIRCUIT BREAKERS

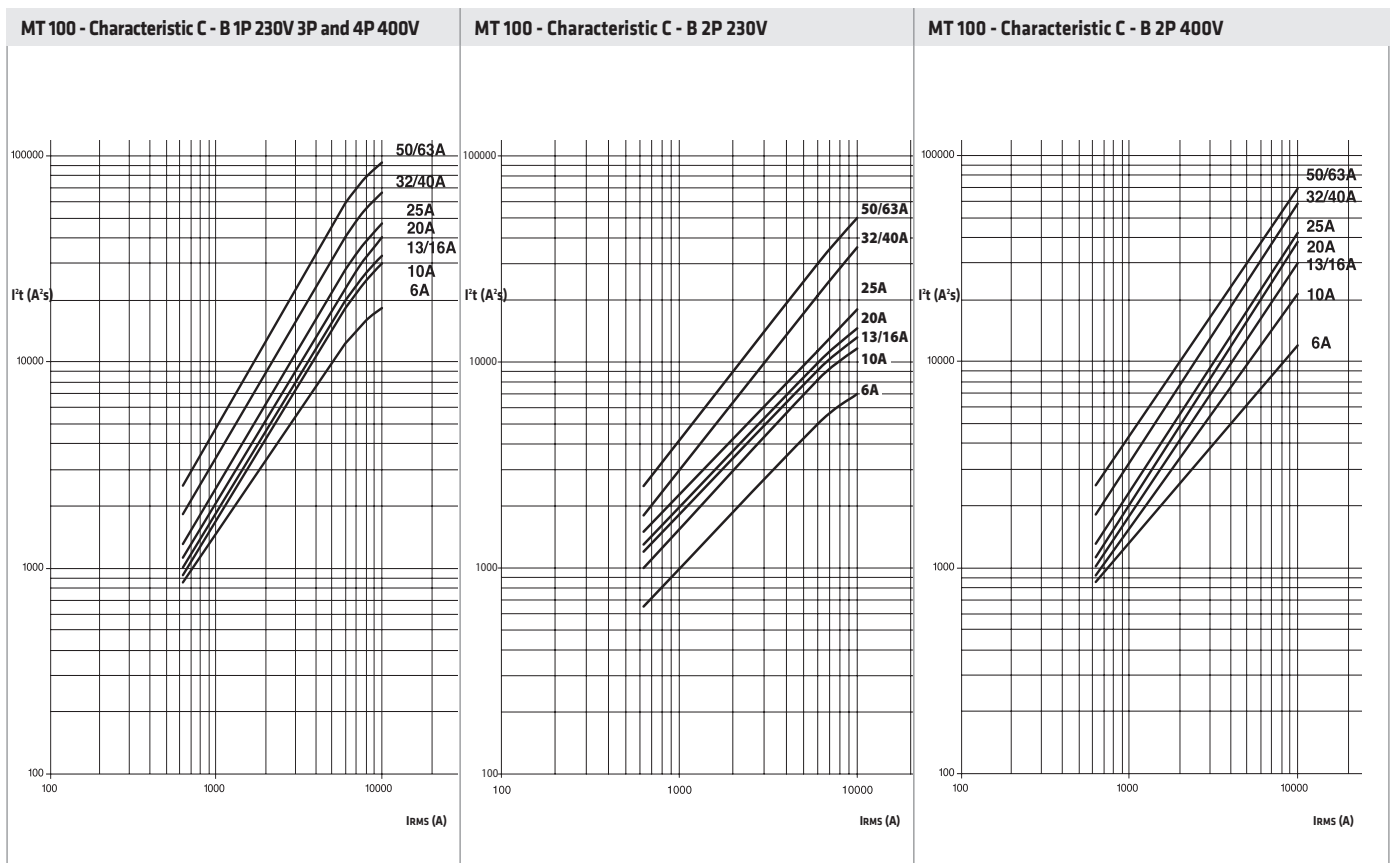
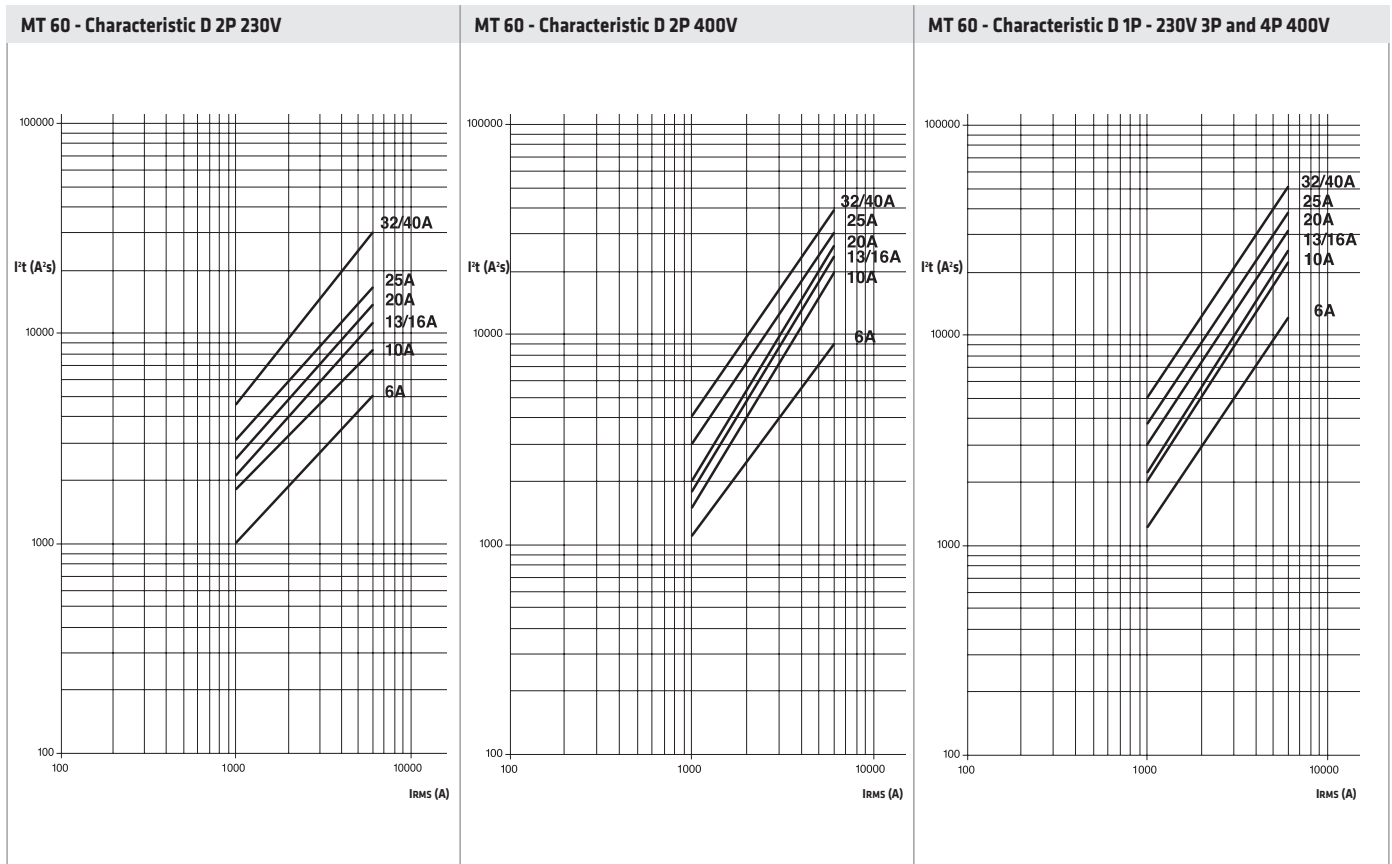

MODULAR CIRCUIT BREAKERS FOR CIRCUIT PROTECTION

SPECIFIC LET-THROUGH ENERGY CHARACTERISTICS - MT 100 - MT 250 MODULAR CIRCUIT BREAKERS

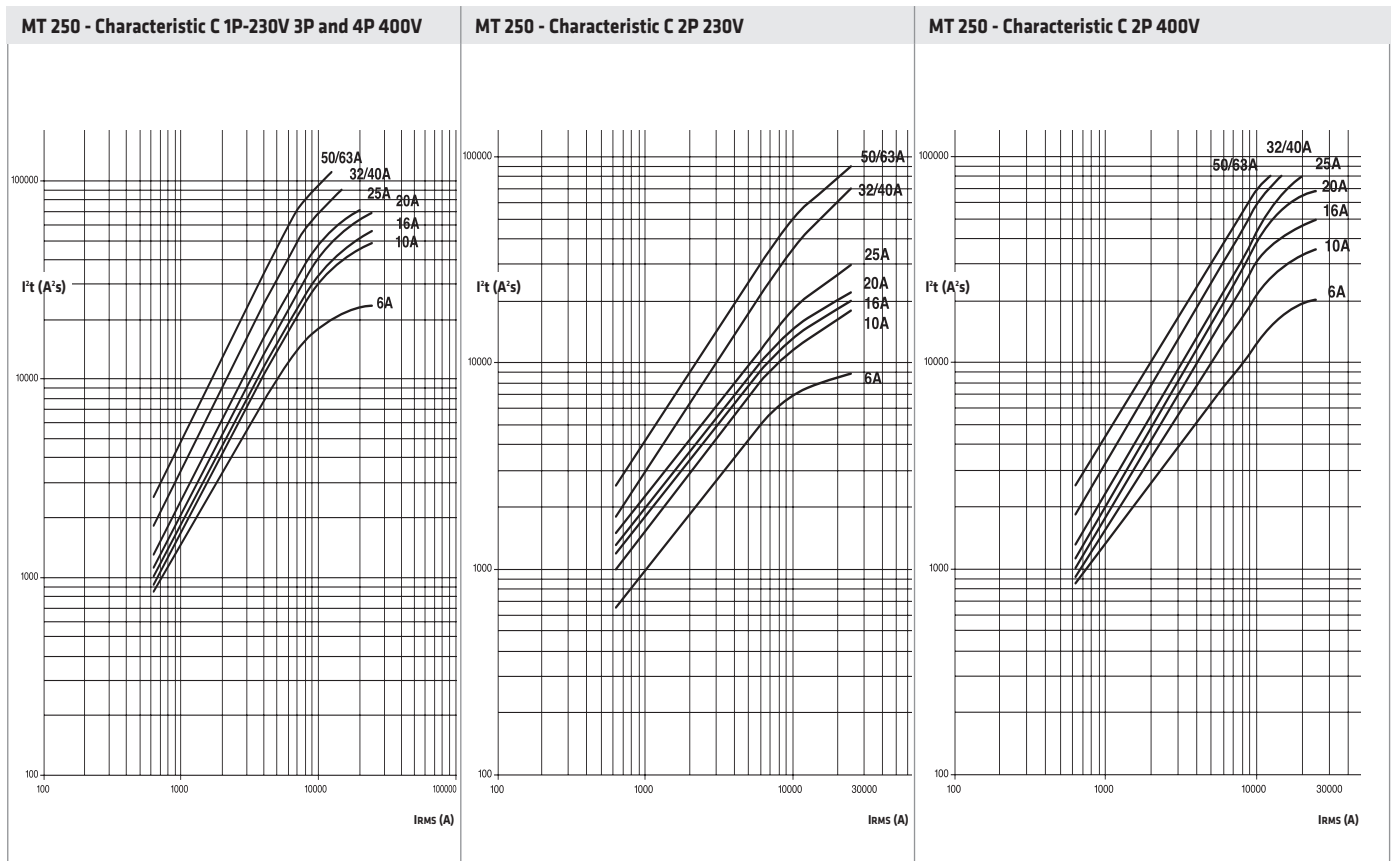
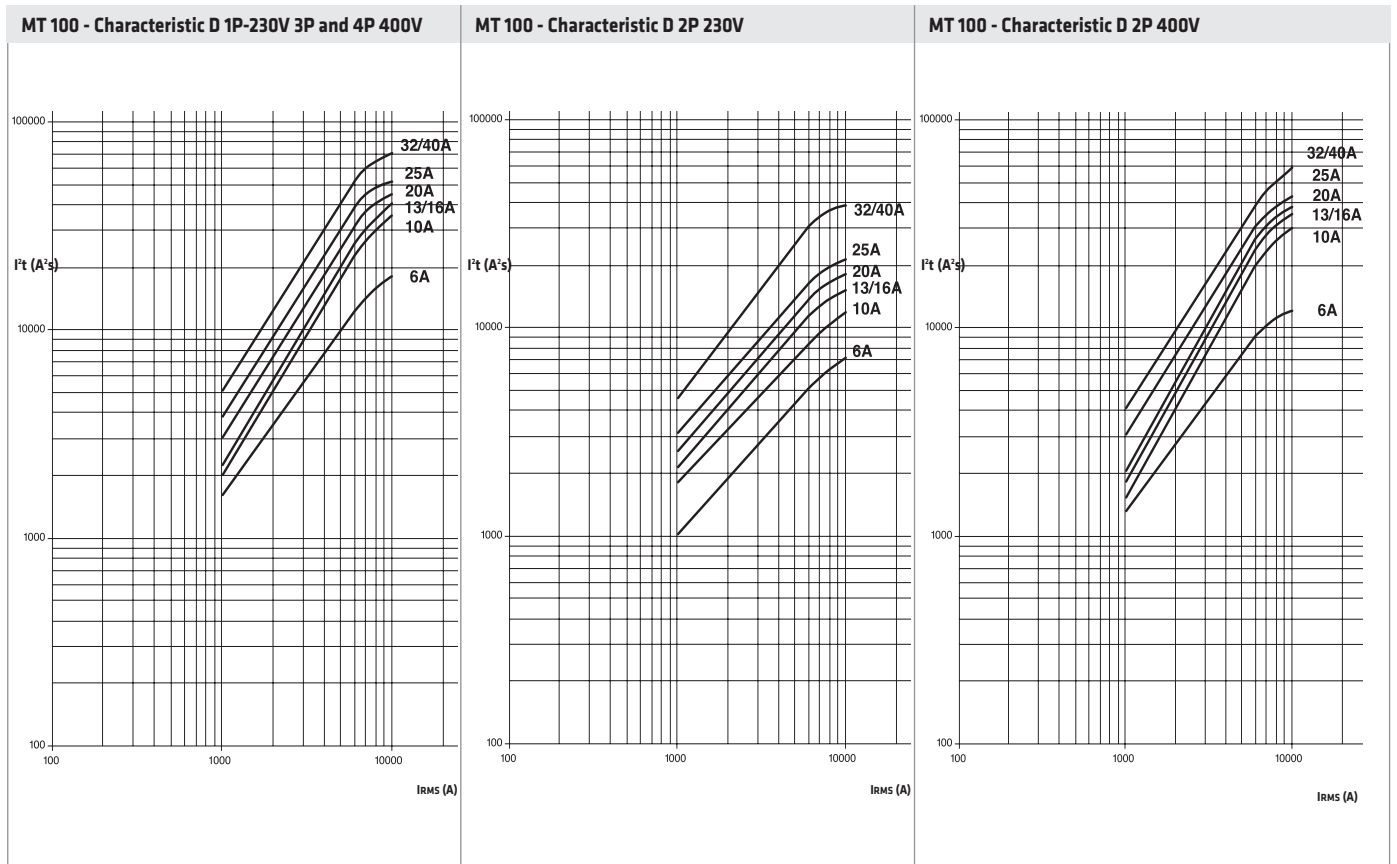

For technical information contact the Technical Assistance Service or visit gewiss.com

SPECIFIC LET-THROUGH ENERGY CHARACTERISTICS - MTHP 250 MODULAR CIRCUIT BREAKERS

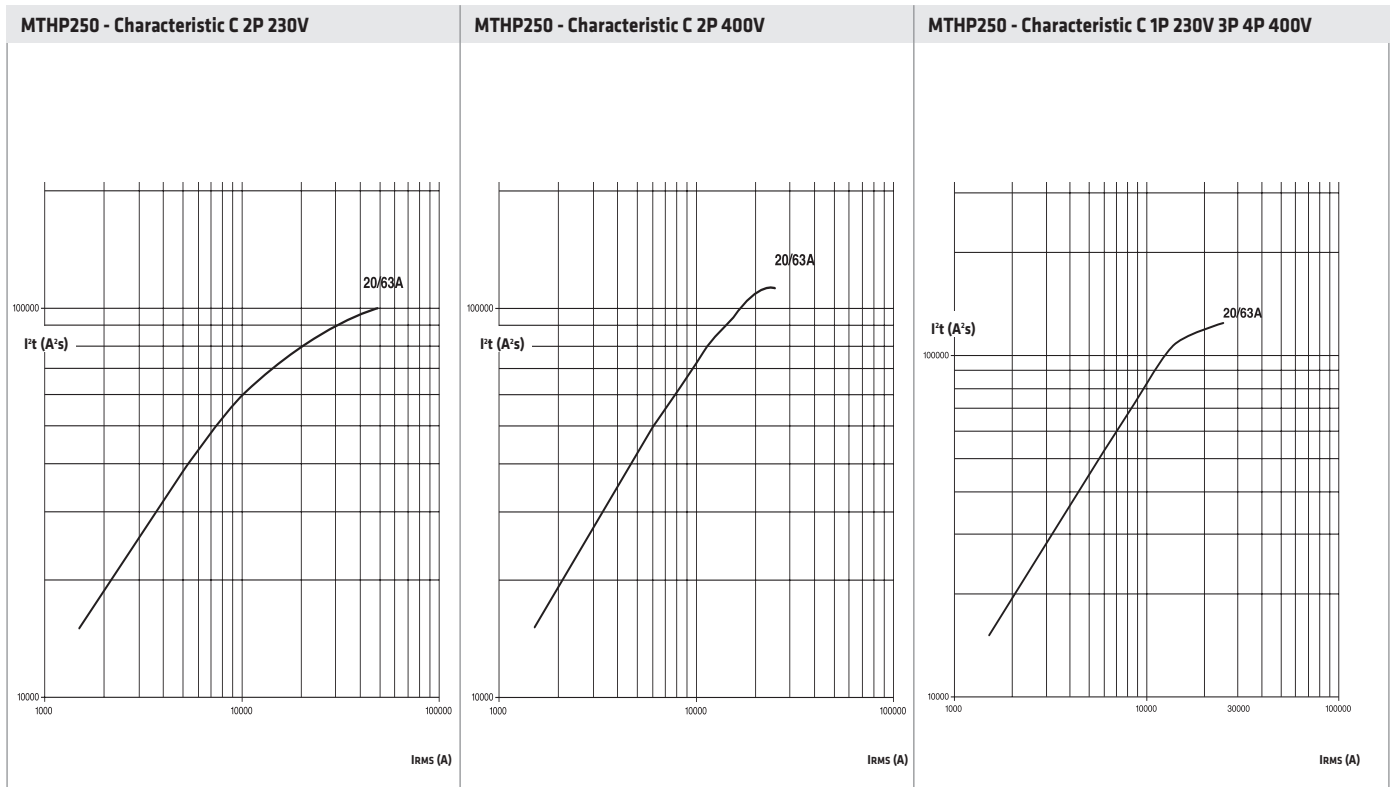

SPECIFIC LET-THROUGH ENERGY CHARACTERISTICS - MTHP 160 MODULAR CIRCUIT BREAKERS

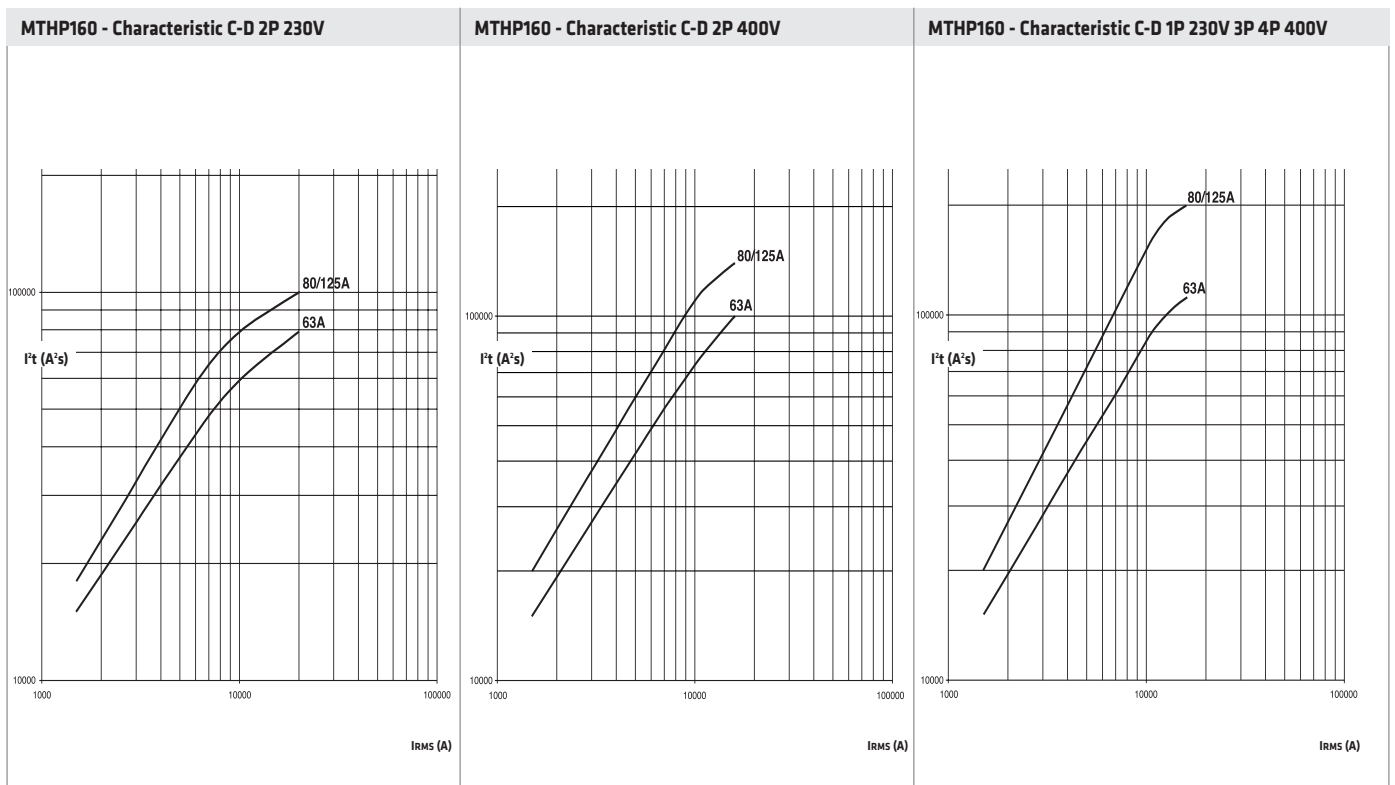

PEAK CURRENT LIMITATION CHARACTERISTICS

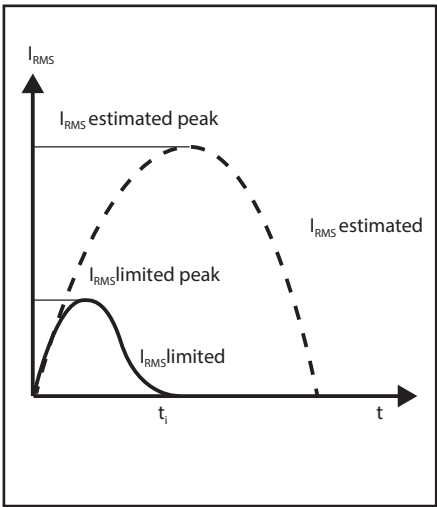
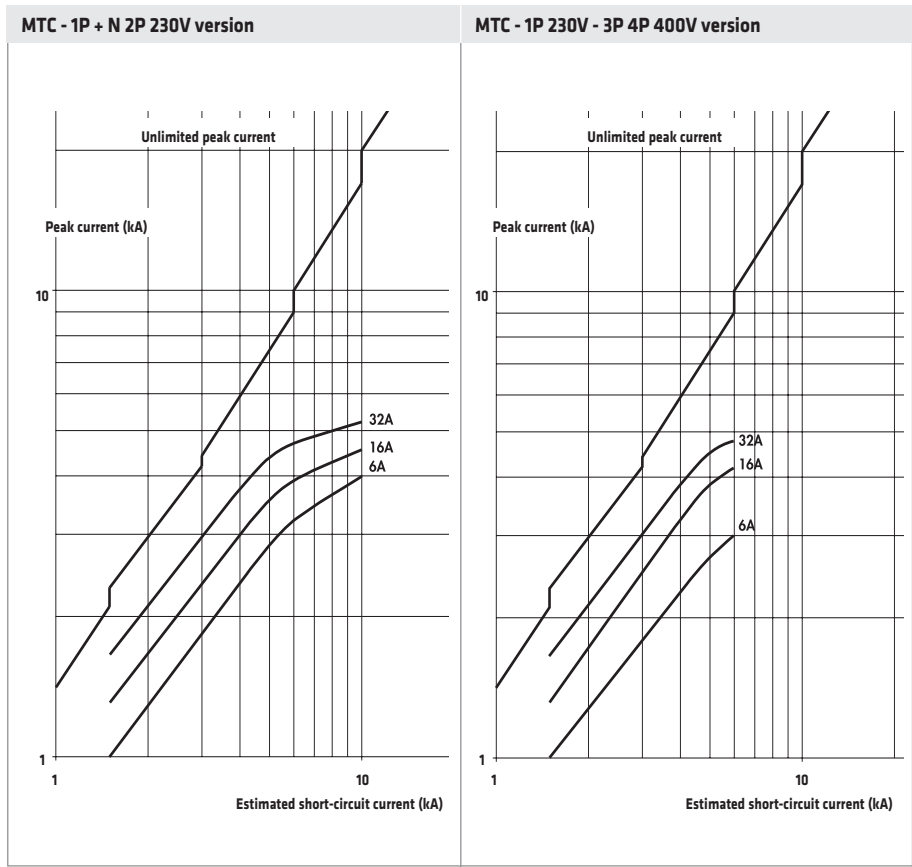

The following curves give the values of the peak current in relation to the estimated short-circuit current expressed in kA. Every curve refers to each rated current value of circuit breaker.

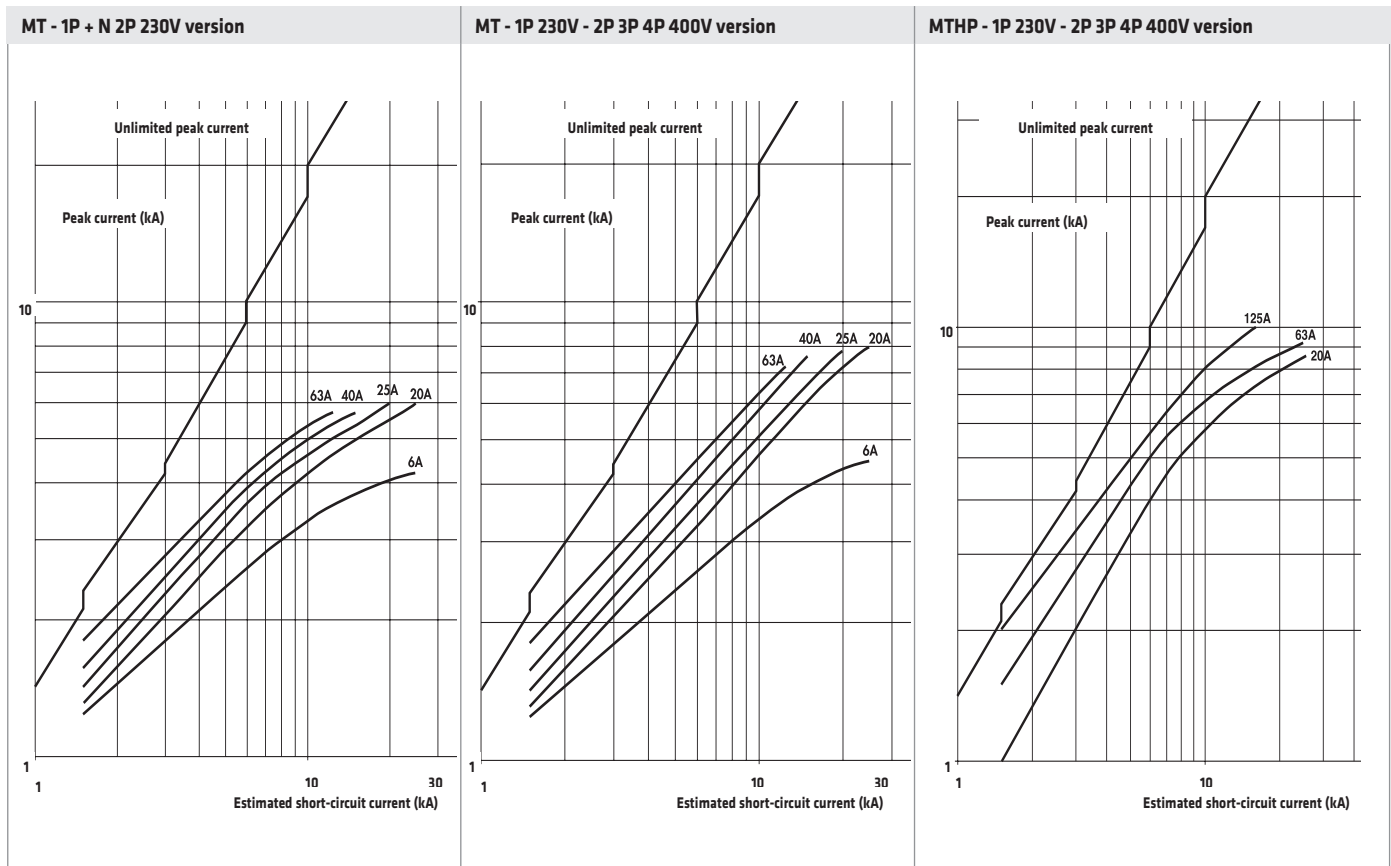

For technical information contact the Technical Assistance Service or visit gewiss.com

HOW TO CHOOSE CIRCUIT BREAKERS FOR DIRECT CURRENT APPLICATIONS

The interruption of direct current is more difficult to achieve than the alternating current because the direct current doesn't go through zero at each half cycle. Therefore, it is necessary to connect in series the poles of the same circuit breaker so that the increase of the resistance, thus created, causes the decrease of the current until its cancellation.

Moreover, if the operating voltage of the system increases, also the number of poles connected in series must increase.

For a correct choice of a circuit breaker to protect DC electrical loads, it's suggested to keep in mind these following 3 factors:

- 1. Operating voltage**, which effects the number of poles to be connected in series. The maximum operating voltage in direct current for Gewiss circuit breaker is equal to 220V by connecting 4 poles in series (max 50V per pole).

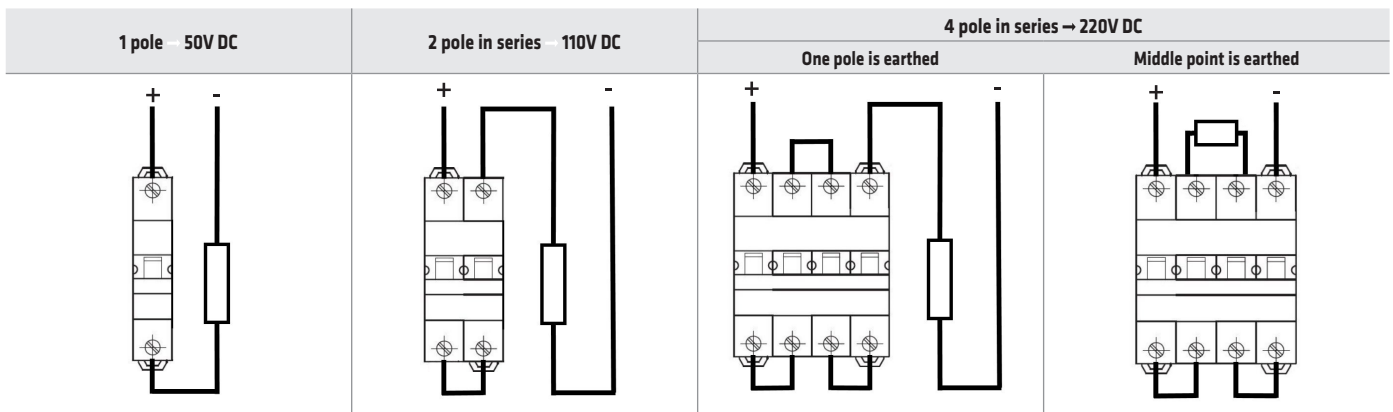

- 2. Short-circuit current**, alleged in the installation point that effects the choice of circuit breaker type.

Circuit breaker type	BREAKING CAPACITY I_{cu} (kA)		
	Operating voltage (V)		
	50	110	220
MTC 45	6	6	4.5
MTC 60	10	10	6
MTC 100	-	10 (*)	-
MT 45	6	6	4.5
MT 60	10	10	10
MT 100	10	15	15
MT 250	20	25	25
MTHP 160	10	15	15
MTHP 250	25	30	25

(*) 15 kA at 50V

- 3. Operating current and the type of electrical load**, which effect the rated current of the circuit breaker and its tripping characteristic. The rated current of the circuit breaker for DC application must be higher than the operating current of electrical load and must be lower or equal to the capacity of the cable, as well as alternating current situation. In addition to inrush current, the choice of tripping characteristics must consider that the DC magnetic trip threshold is greater than alternating current. Hereafter the tripping characteristics according to EN 60898 of circuit breakers used in direct current.

Tripping characteristics in direct current (EN 60898)

MTC 45 - 60 - 100 Characteristic C
 MT 45 - MT 60 - 100 - 250 Characteristic C
 MTHP 160 - 250 Characteristic C

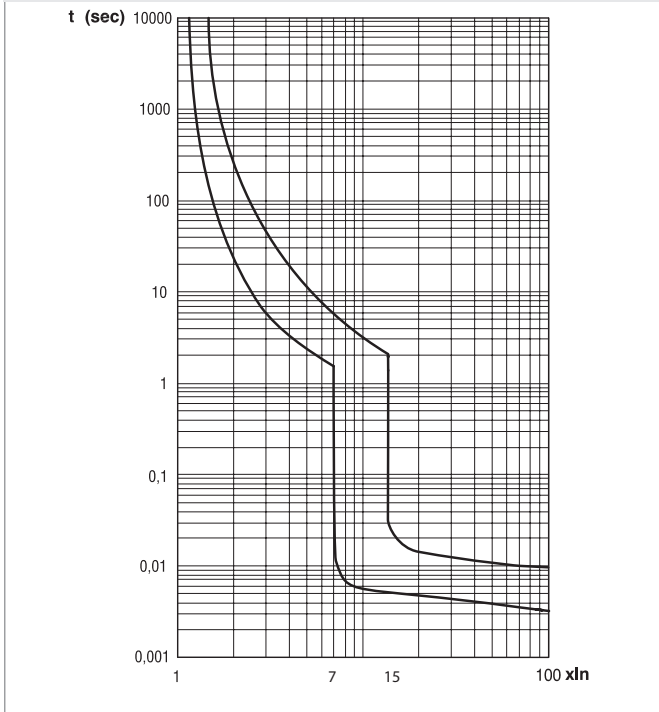

MT 45 - MT 60 - 100 Characteristic B
 MTC 60 Characteristic B

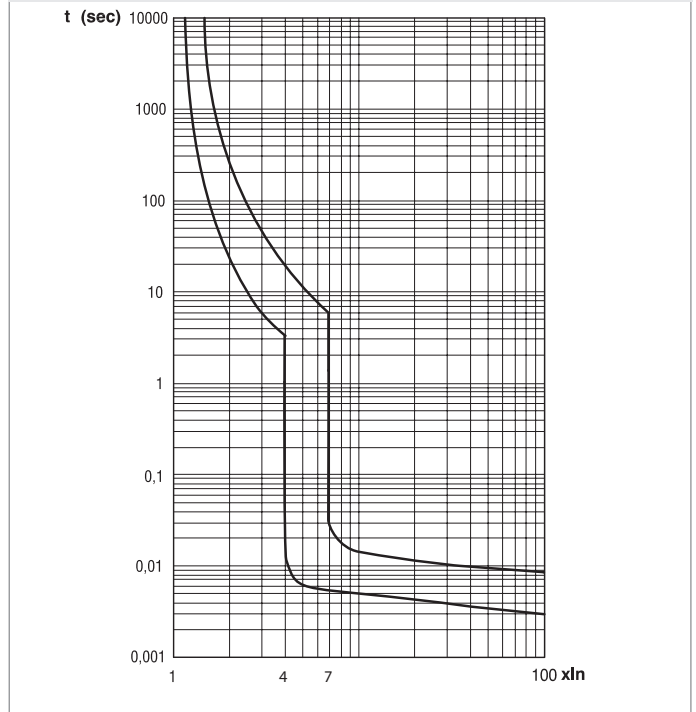

MT 60 - 100 Characteristic D
 MTHP 160 Characteristic D

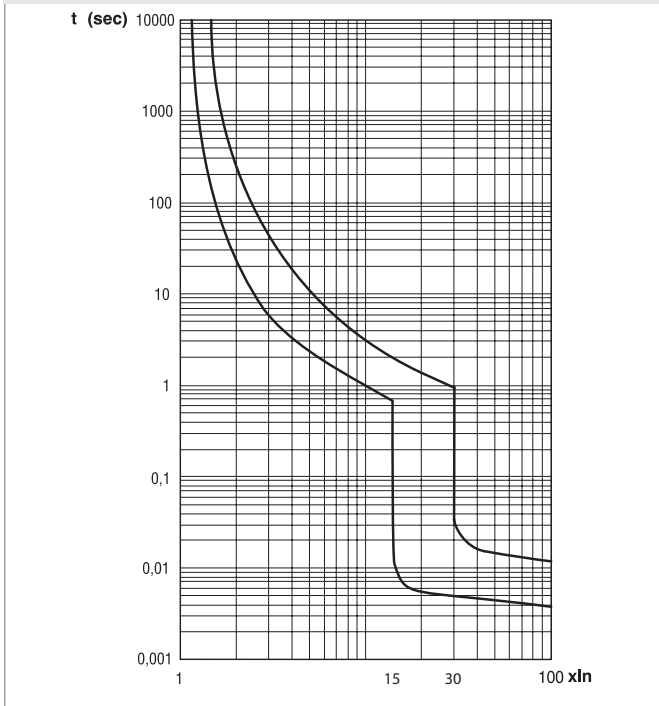

Tripping characteristic	B	C	D
I_n	from 6 to 63 A	from 1 to 125 A	from 6 to 100 A
Thermal release			
I_{nf}	1,13 I_n	1,13 I_n	1,13 I_n
I_f	1,45 I_n	1,45 I_n	1,45 I_n
t	< 1 h	< 1 h	< 1 h
Magnetic release			
I_{nf}	4 I_n	7 I_n	15 I_n
I_f	7 I_n	15 I_n	30 I_n
t	instantaneous	instantaneous	instantaneous

I_n = rated current
 I_{nf} = conventional non-tripping current
 I_f = conventional tripping current
 t = tripping time

B tripping curve: tripping characteristic for the protection of electrical resistive loads (for example: heating) and very long electrical distribution lines.

C tripping curve: tripping characteristic for the protection of general electrical resistive or slight inductive loads (for example: fluorescent lamps).

D tripping curve: tripping characteristic for the protection of electrical heavy inductive loads or high starting currents (for example: electrical engines).

MODULAR CIRCUIT BREAKERS FOR CIRCUIT PROTECTION

COORDINATION TABLES BACKUP

Back-up protection means to put two circuit breakers in series using their capacity to limit the short circuit in order to install a downstream circuit breaker with breaking capacity lower than required. Therefore, the upstream circuit breaker (with breaking capacity at least equal to the estimated short circuit current at the point of installation) trips to help the downstream circuit breaker to break the short circuit increasing its breaking capacity. Back-up protection is useful in every electrical installation where the continuity of working is not a fundamental requirement (as instead for selective protection) but there are other priority needs:

- to decrease the costs of electrical system because back-up allows the choice of circuit breakers with lower breaking capacity than required and therefore less expensive;

		BACK UP TABLES - 400V AC UPSTREAM - 230V AC DOWNSTREAM (EN 60947-2)											
UPSTREAM		400V (AC)											
DOWNSTREAM	RANGE	RANGE		MT60	MT100			MT250					
		In [A]	Icu [kA]	1÷63	1÷25	32÷63	6÷20	25	32÷63				
230V (AC)	Range												
	MTC/MDC45	6÷32	6	7,5	7,5	7,5	10	10	10	10	10	10	7,5
	MTC/MDC60	6÷32	7,5	10	10	10	10	15	15	15	15	15	10
	MTC/MDC100	6÷32	10			15	12,5	17,5	17,5	17,5	17,5	17,5	12,5
	MT60	1÷63 (1P+N)	10			15	12,5	17,5	17,5	17,5	17,5	17,5	12,5
		1÷63 (2P)	20					25					
	MT100	1÷25	30										
		32÷63	25										
	MT250	6÷20	50										
		25	40										
		32÷40	30										
	MTHP160	63÷125	20										
MTHP250		20÷63	50										

		BACK UP TABLES - 400V AC UPSTREAM - 400V AC DOWNSTREAM (EN 60947-2)													
UPSTREAM		400V (AC)													
DOWNSTREAM	RANGE	RANGE		MT60	MT100			MT250			MTHP160	MTHP250	MTX 160c		
		In [A]	Icu [kA]	1÷63	1÷25	32÷63	6÷20	25	32÷63	63÷125	20÷63	160			
400V (AC)	Range														
	MTC 45/MDC45	6÷32	4,5	6	7,5	6	10	10	7,5	6	6	6	6	6	6
	MTC 60/MDC60	6÷32	6	10	12	10	15	15	12	10	10	10	10	10	10
	MT 60	1÷63	10			15	12	18	18	15	16	20	16	20	20
		1÷25	15					25	20		16	25	16	25	25
	MT 100	32÷63	12,5					25	20	15	16	20	16	25	25
		6÷20	25												36
	MT 250	25	20									25		25	25
		32÷63	15								16	20	16	25	25
	MTHP 160	63÷125	16												
	MTHP 250	20÷63	25												
	MTX160c	160	16											25	36
			25											36	
			36												
	MTX/E 160	160	36												
			50												
	MTX 250	250	70												
			36												
	MTX/E 320	320	50												
			70												
			120												
	MTX/E 630	630	36												
			50												
			70												
MTX/E 1000	1000	120													
		36													
		50													
		70													
		100													
		36													
		50													

Note: kA values

For technical information contact the Technical Assistance Service or visit gewiss.com

MODULAR CIRCUIT BREAKERS FOR CIRCUIT PROTECTION

- to limit the size of circuit breakers;
- to maintain existing electrical systems even if they are not still suitable to break the new value of short-circuit.

The following tables cover the possible combinations between Gewiss circuit breakers range for electrical networks 230 and 400V in order the specific let-through energy of upstream circuit breaker is not so high to damage the downstream circuit breaker. The numbers give the value of the breaking capacity expressed in kA considering the combination of the two switches selected.

BACK UP TABLES - 400V AC UPSTREAM - 230V AC DOWNSTREAM (EN 60947-2)

400V (AC)											
MTHP160		MTHP250		MTX 160c			MTX/E 160			MTX 250	
63÷125		20÷63		160			160			250	
16	25	16	25	36	36	50	70	36	50		
7,5	10	7,5	10	10							
10	17,5	10	12,5	16	10	16	16	10	16		
12,5	20	16	16	16	16	16	16	16	16		
12,5	20	16	16	16	16	16	16	16	16		
	25		25	30	25	30	30	25	30		
				36	36	40	50	36	40		
				36	36	40	50	36	40		
						50	50		50		
				36	36	50	50	36	50		
				36	36	36	50	36	36		
					25	36	36	25	36		

BACK UP TABLES - 400V AC UPSTREAM - 400V AC DOWNSTREAM (EN 60947-2)

400V (AC)																				
MTX/E 160			MTX 250		MTX/E 320				MTX/E 630				MTX/E 1000				MTSE 1600			
160			250		320				630				1000				1600			
36	50	70	36	50	36	50	70	120	36	50	70	120	36	50	70	100	50	65	100	
10	10	10			10	10	10	10												
20	20	20	16	16	20	20	20	20												
25	30	30	25	30	25	25	25	30												
25	25	25	20	25	25	25	25	30												
30	36	36	30	30	30	30	30	30												
30	36	36	25	25	25	30	30	30												
25	25	30	20	20	20	25	25	25												
25	25	30	20	20	20	25	25	25												
30	30	36	30	30	30	30	30	30												
36	50	70	36	50	30	36	40	50	30	36	40	50	30	36	40	50				
36	50	70	36	50	36	40	65	85	36	40	65	85	36	50	65	70	50	50	50	
	50	70		50		50	65	100		50	65	100		50	65	70	50	50	50	
	50	70		50		50	65	100		50	65	100		50	65	85	50	65	85	
							70	100			70	100			70	85		65	85	
								120				120				85			85	
				50		50	65	100		50	65	100		50	65	100	50	50	50	
							70	100			70	100			70	100		65		
						50	65	100		50	65	100		50	65	65	50	50	65	
							70	100			70	100			70	85		65	85	
								120				120				100			100	
										50	65	100		50	65	85	50	50	65	
											70	100			70	85		65	85	
												120				100			100	
															50	65	70	40	40	
																70	85		85	
																100				

For technical information contact the Technical Assistance Service or visit gewiss.com

MODULAR CIRCUIT BREAKERS FOR CIRCUIT PROTECTION

SELECTIVITY TABLES

The following tables show the energy selectivity type combination between each circuit breaker belonging to the Gewiss range. The energy selectivity type, as other types, has the aim to ensure maximum continuity of working, even in the case of fault, suppling only the electrical circuits without fault and tripping the circuit breakers of fault circuits. This coordination requires the upstream circuit breaker is dimensioned enough to let pass the fault current for a time as long as necessary the downstream circuit breaker trips. The energy selectivity can be of two types:

SELECTIVITY TABLE - 400 Vac UPSTREAM - 400 Vac DOWNSTREAM (EN 60947-2)																									
UPSTREAM		MTX 160c										MTXE 160				MTX 250									
DOWNSTREAM		TM1										SEP/1				TM1									
Range	Curve	In	16	20	25	32	40	50	63	80	100	125	160	10	25	63	100	160	63	80	100	125	160		
MTC 45 MDC 45	C	6	T	T	T	T	T	T	T	T	T	T	T		T	T	T	T	T	T	T	T	T	T	
		10		3	3	3	3	3	3	5	5	5	5	5		T	T	T	T	T	T	T	T	T	T
		16					3	3	3	4,5	4,5	4,5	4,5	4,5			T	T	T	T	T	T	T	T	T
		20					3	3	3	3,5	3,5	3,5	3,5	3,5			T	T	T	T	5,5	5,5	5,5	5,5	5,5
		25							3	3,5	3,5	3,5	3,5	3,5			T	T	T	T	5,5	5,5	5,5	5,5	5,5
		32							3		4,5	4,5	4,5	4,5			T	T	T		4,5	4,5	4,5	4,5	4,5
MTC 60/100 MDC 60/100	B/C	6	5,5	5,5	5,5	5,5	5,5	5,5	T	T	T	T	T		T	T	T	T	T	T	T	T	T	T	
		10			3	3	3	3	4,5	5	8,5	8,5	8,5	8,5		T	T	T	T	7,5	8,5	8,5	8,5	8,5	
		16				3	3	3	4,5	4,5	7,5	7,5	7,5	7,5			T	T	T	5	7,5	7,5	7,5	7,5	
		20				3	3	3	3,5	5,5	5,5	5,5	5,5	5,5			T	T	T	5	5,5	5,5	5,5	5,5	
		25						3	3,5	5,5	5,5	5,5	5,5	5,5			T	T	T	5	5,5	5,5	5,5	5,5	
		32						3		4,5	5,5	5,5	5,5	5,5			T	T	T		4,5	7	7	7	
MT 60	B/C	1	T	T	T	T	T	T	T	T	T	T	T	T	T	T	T	T	T	T	T	T	T	T	
		2	T	T	T	T	T	T	T	T	T	T	T	T	T	T	T	T	T	T	T	T	T	T	
		3	T	T	T	T	T	T	T	T	T	T	T	T	T	T	T	T	T	T	T	T	T	T	
		4	T	T	T	T	T	T	T	T	T	T	T	T	T	T	T	T	T	T	T	T	T	T	
		6	5,5	5,5	5,5	5,5	5,5	5,5	5,5	T	T	T	T	T		T	T	T	T	T	T	T	T	T	
		10			3	3	3	3	4,5	5,5	8,5	8,5	8,5	8,5		T	T	T	T	7,5	8,5	8,5	8,5	8,5	
		16					3	3	4,5	4,5	7,5	7,5	7,5	7,5			T	T	T	5	7,5	7,5	7,5	7,5	
		20						3	3,5	5,5	5,5	5,5	5,5	5,5			T	T	T	5	5,5	5,5	5,5	5,5	
		25								3,5	5,5	5,5	5,5	5,5			T	T	T	5	5,5	5,5	5,5	5,5	
		32									4,5	7	7	7			T	T	T		4,5	7	7	7	
		40										7	7	7				T	T			7	7	7	
50											6	6				T	T				6	6			
63												T				T	T					T			
MT 60	D	6	5,5	5,5	5,5	5,5	5,5	5,5	T	T	T	T	T		T	T	T	T	T	T	T	T	T		
		10			3	3	3	3	5	7	8	8	8		T	T	T	T	5	8,5	8,5	8,5	8,5		
		16					2	2	3	5	8	8	8			T	T	T	3	5	8	8	8		
		20						2	3	4,5	6,5	8	8			T	T	T	3	4,5	6,5	8	8		
		25								2,5	4	6	8			T	T	T	2,5	4	6	9,5	9,5		
		32									4	6	8			T	T	T		4	6	9,5	9,5		
MT 100	B/C	6	5,5	5,5	5,5	5,5	5,5	5,5	10,5	T	T	T	T		T	T	T	T	10,5	T	T	T	T		
		10			3	3	3	3	5,5	8,5	8,5	8,5	8,5		T	T	T	T	7,5	8,5	8,5	8,5	8,5		
		16					3	3	4,5	7,5	12	12	12			T	T	T	5	7,5	12	12	12		
		20						2,5	3,5	5,5	7,5	7,5	7,5			T	T	T	5	5,5	8	12	12		
		25								3,5	5,5	7,5	7,5			T	T	T	5	5,5	8	12	12		
		32									4,5	7	12			T	T	T		4,5	7	12	12		
		40										7	12				T	T			7	12	12		
		50											6	10,5				10,5	10,5				6	10,5	
63												10,5				10,5						10,5			
MT 100	D	6	5,5	5,5	5,5	5,5	5,5	10,5	T	T	T	T	T		T	T	T	T	10,5	T	T	T	T		
		10			3	3	3	3	5	8,5	8,5	8,5	8,5		T	T	T	T	5	8,5	8,5	8,5	8,5		
		16					2	2	3	5	8	13,5	13,5			T	T	T	3	5	8	13,5	13,5		
		20						2	3	4,5	6,5	11	11			T	T	T	3	4,5	6,5	11	11		
		25								2,5	4	6	9,5			T	T	T	2,5	4	6	9,5	9,5		
		32									4	6	9,5			T	T	T		4	6	9,5	9,5		

Note: T= total selectivity - kA values

For technical information contact the Technical Assistance Service or visit gewiss.com

MODULAR CIRCUIT BREAKERS FOR CIRCUIT PROTECTION

SELECTIVITY TABLES

SELECTIVITY TABLE - 400 V _{ac} UPSTREAM - 400 V _{ac} DOWNSTREAM (EN 60947-2)																										
UPSTREAM		MTX 160c												MTXE 160					MTX 250							
DOWNSTREAM		TM1												SEP/1					TM1							
Range	Curve	In	16	20	25	32	40	50	63	80	100	125	160	10	25	63	100	160	63	80	100	125	160			
MTX 250	C	6	5,5	5,5	5,5	5,5	5,5	5,5	10,5	T	T	T	T		T	T	T	T	10,5	T	T	T	T			
		10		3	3	3	3	3	5,5	8,5	T	T	T		T	T	T	T	7,5	8,5	T	T	T			
		16						3	3	4,5	7,5	12	T	T			T	T	T	5	7,5	12	T	T		
		20							2,5	3,5	5,5	7,5	T	T			T	T	T	5	5,5	8	T	T		
		25									3,5	5,5	7,5	T	T			T	T	T	5	5,5	8	T	T	
		32										4,5	7	12	T			T	T	T		4,5	7	12	T	
		40											7	12	T				T	T			7	12	T	
		50												6	10,5				10,5	10,5					6	10,5
		63																		10,5						10,5
MTHP 160	C	80												6					6							
		100																								
		125																								
MTHP 160	D	80										6	7,5					7,5						9,5		
		100											6					6								
		125																								
MTHP 250	C	20					5,5	5,5	T	T	T	T	T			T	T	T	2,5	5,5	8	T	T			
		25							3,5	5,5	7,5	T	T			3,5	7,5	T		5	8	T	T			
		32								4,5	7	T	T				7	T		4,5	7	T	T			
		40									7	T	T				7	T			7	T	T			
		50										6	T						T				6	T		
		63												T					T						10	
MTX 160c		16											3			3	3	3						3		
		20												3			3	3	3						3	
		25												3			3	3	3						3	
		32												3				3	3						3	
		40												3				3	3						3	
		50												3				3	3						3	
		63												3					3						3	
		80																		3						
		100																								
		125																								
160																										
MTXE 160		10																								
		25																								
		63																								
		100																								
		160																								
MTX 250		63																						3		
		80																						3		
		100																								
		125																								
		160																								
		200																								
250																										

Note: T= total selectivity - kA values

For technical information contact the Technical Assistance Service or visit [gewiss.com](http://www.gewiss.com)

MODULAR CIRCUIT BREAKERS FOR CIRCUIT PROTECTION

SELECTIVITY TABLE - 400 Vac UPSTREAM - 400 Vac DOWNSTREAM (EN 60947-2)																								
MTX 250		MTX 320						MTXE 320				MTX 630			MTXE 630		MTX 1000		MTXE 1000			MTSE 1600		
TM1		TM2						SEP/1 - SEP/2				TM2			SEP/1 - SEP/2		TM2		SEP/1 - SEP/2			SEP/A - SEP/B		
200	250	100	125	160	200	250	100	160	250	320	320	400	500	400	630	630	800	630	800	1000	1000	1250	1600	
T	T	T	T	T	T	T	T	T	T	T	T	T	T	T	T	T	T	T	T	T	T	T	T	
T	T	T	T	T	T	T	T	T	T	T	T	T	T	T	T	T	T	T	T	T	T	T	T	
T	T	T	T	T	T	T	T	T	T	T	T	T	T	T	T	T	T	T	T	T	T	T	T	
T	T	T	T	T	T	T	T	T	T	T	T	T	T	T	T	T	T	T	T	T	T	T	T	
T	T	T	T	T	T	T	T	T	T	T	T	T	T	T	T	T	T	T	T	T	T	T	T	
T	T	T	T	T	T	T	T	T	T	T	T	T	T	T	T	T	T	T	T	T	T	T	T	
T	T	T	T	T	T	T	T	T	T	T	T	T	T	T	T	T	T	T	T	T	T	T	T	
T	T	T	T	T	T	T	T	T	T	T	T	T	T	T	T	T	T	T	T	T	T	T	T	
T	T	T	T	T	T	T	T	T	T	T	T	T	T	T	T	T	T	T	T	T	T	T	T	
9,5	T	T	T	T	T	T	T	T	T	T	T	T	T	T	T	T	T	T	T	T	T	T	T	
	T	T	T	T	T	T	T	T	T	T	T	T	T	T	T	T	T	T	T	T	T	T	T	
		T	T	T	T	T	T	T	T	T	T	T	T	T	T	T	T	T	T	T	T	T	T	
T	T	T	T	T	T	T	T	T	T	T	T	T	T	T	T	T	T	T	T	T	T	T	T	
9,5	T	T	T	T	T	T	T	T	T	T	T	T	T	T	T	T	T	T	T	T	T	T	T	
		T	T	T	T	T	T	T	T	T	T	T	T	T	T	T	T	T	T	T	T	T	T	
T	T	T	T	T	T	T	T	T	T	T	T	T	T	T	T	T	T	T	T	T	T	T	T	
T	T	T	T	T	T	T	T	T	T	T	T	T	T	T	T	T	T	T	T	T	T	T	T	
T	T	T	T	T	T	T	T	T	T	T	T	T	T	T	T	T	T	T	T	T	T	T	T	
T	T	T	T	T	T	T	T	T	T	T	T	T	T	T	T	T	T	T	T	T	T	T	T	
T	T	6	T	T	T	T	T	T	T	T	T	T	T	T	T	T	T	T	T	T	T	T	T	
T	T		T	T	T	T	T	T	T	T	T	T	T	T	T	T	T	T	T	T	T	T	T	
4	5	10	10	10	10	10	10	10	10	10	T	T	T	T	T	T	T	T	T	T	T	T	T	
4	5	10	10	10	10	10	10	10	10	10	T	T	T	T	T	T	T	T	T	T	T	T	T	
4	5	10	10	10	10	10	10	10	10	10	T	T	T	T	T	T	T	T	T	T	T	T	T	
4	5	10	10	10	10	10	10	10	10	10	T	T	T	T	T	T	T	T	T	T	T	T	T	
4	5	10	10	10	10	10	10	10	10	10	T	T	T	T	T	T	T	T	T	T	T	T	T	
4	5		10	10	10	10	10	10	10	10	T	T	T	T	T	T	T	T	T	T	T	T	T	
4	5			10	10	10		10	10	10	T	T	T	T	T	T	T	T	T	T	T	T	T	
	5			10	10	10		10	10	10	T	T	T	T	T	T	T	T	T	T	T	T	T	
					10	10			10	10	T	T	T	T	T	T	T	T	T	T	T	T	T	
									10	10	T	T	T	T	T	T	T	T	T	T	T	T	T	
3	4	25	25	25	25	25	25	25	25	25	T	T	T	T	T	T	T	T	T	T	T	T	T	
3	4	25	25	25	25	25	25	25	25	25	T	T	T	T	T	T	T	T	T	T	T	T	T	
3	4			25	25	25	25	25	25	25	T	T	T	T	T	T	T	T	T	T	T	T	T	
3	4					25		25	25	25	T	T	T	T	T	T	T	T	T	T	T	T	T	
3	4								25	25	T	T	T	T	T	T	T	T	T	T	T	T	T	
4	5		7	7	7	7	7	7	7	7	25	25	25	25	25	T	T	T	T	T	T	T	T	
4	5			7	7	7		7	7	7	25	25	25	25	25	T	T	T	T	T	T	T	T	
4	5			7	7	7		7	7	7	25	25	25	25	25	40	T	40	T	T	T	T	T	
					7				7	7	20	20	20	20	20	36	T	36	T	T	T	T	T	
									7	7			20	20	20	36	T	36	T	T	T	T	T	
										7				20	20	30	T	30	T	T	T	T	T	
														20	20	30	40	30	40	40	T	T	T	

For technical information contact the Technical Assistance Service or visit gewiss.com

Protection of lighting circuits

Determining the rated current of the circuit breaker

To select the most suitable rated current of the miniature circuit breaker for lighting circuit protection, it is necessary to know the operating current provided by the lighting device manufacturer, or calculated on the basis of the type of lamp and the relative technical data (rated power, power supply voltage and power factor). Once the operating current is known, you should choose the circuit breaker version with the rated current value immediately above this value. The tables below show the maximum number of lamps that can be protected, on the basis of the rated current. For all case, you are advised to choose a circuit breaker with tripping characteristic C.

SINGLE-PHASE 230V AC - THREE-PHASE DISTRIBUTION 400V AC WITH NEUTRAL ⁽¹⁾														
Rated current In (A):		6	10	13	16	20	25	32	40	50	63	80	100	125
FLUORESCENT lamps	Lamp power (W)	Number of lamps per phase												
		Single without P.F. correction (cos = 0.6)	18	24	36	61	79	98	122	153	196	245	306	386
	36	12	18	30	39	49	61	76	98	122	153	193	245	306
	58	7	11	19	24	30	38	47	60	76	95	119	152	190
Single with P.F. correction (cos = 0.86) ⁽²⁾	18	35	52	87	114	140	175	219	281	351	439	553	703	879
	36	17	26	43	57	70	87	109	140	175	219	276	351	439
	58	10	16	27	35	43	54	68	87	109	136	171	218	272
Double with P.F. correction (cos = 0.86) ⁽²⁾	2 x 18	17	26	43	57	70	87	109	140	175	219	276	351	439
	2 x 36	8	13	21	28	35	43	54	70	87	109	138	175	219
	2 x 58	5	8	13	17	21	27	34	43	54	68	85	109	136

⁽¹⁾ Star connection

⁽²⁾ The values given are valid for lamps with inductive ballast and starter. In the case of lamps with an electronic power supply, the number of lamps indicated should be halved

THREE-PHASE DISTRIBUTION 230V AC and 400V AC ⁽³⁾		
DISCHARGE lamps	Power (W) ⁽⁴⁾	Current In (A)
Mercury vapor lamp	≤ 700	6
	≤ 1000	10
	≤ 2000	16
Metal halide lamp	≤ 375	6
	≤ 1000	10
	≤ 2000	16
High pressure sodium vapor lamp	≤ 400	6
	≤ 1000	10

⁽³⁾ With ballast with or without P.F. correction, and star or delta connection

⁽⁴⁾ The values given refer to the maximum values for each start-up

SINGLE PHASE DISTRIBUTION 230 V a.c.																
Tripping characteristic C																
Rated current In (A)			6	10	13	16	20	25	32	40	50	63	80	100	125	
SMART LED lamps	Lamp power (W)	Number lamps per phase														
		2L		31	-	10	17	23	32	44	59	78	100	129	168	214
2+2L		62	-	6	10	14	19	26	35	46	59	76	99	126	159	
4L		62	-	6	10	14	19	26	35	46	59	76	99	126	159	
5L		69	-	4	7	10	14	19	26	34	44	57	74	94	119	
4+4L		124	-	3	5	7	9	13	17	23	29	38	49	63	79	
5+5L		138	-	2	3	5	7	9	13	17	22	28	37	47	59	
4x4L		248	-	1	2	3	4	6	8	11	14	19	24	31	39	
4x5L		276	-	-	1	2	3	4	6	8	11	14	18	23	29	

For technical information contact the Technical Assistance Service or visit gewiss.com

Dimension tables

MTC 45 - MTC 60 - MTC 100

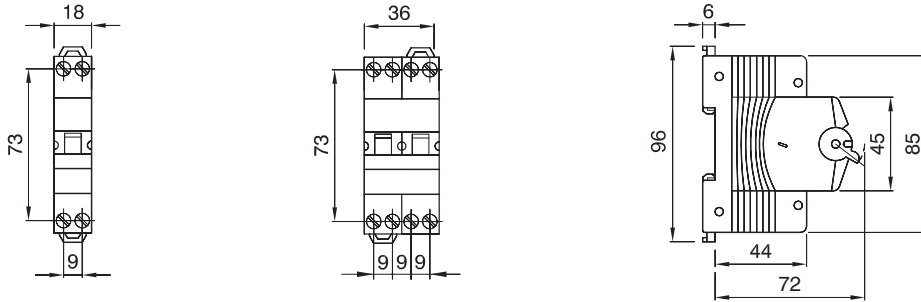

MT45 - MT 60 - MT 100 - MT 250

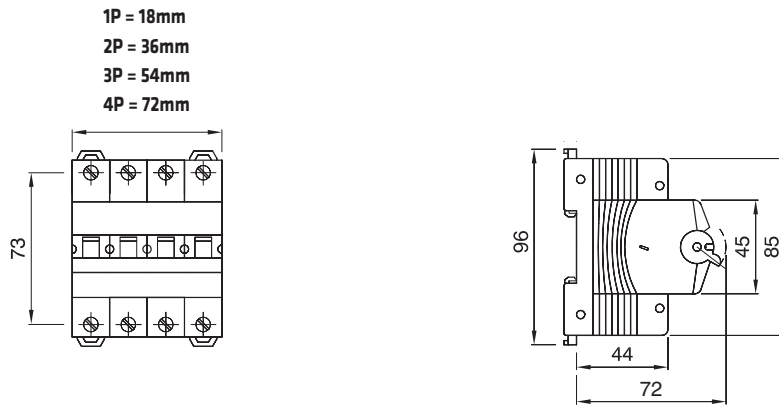

MTHP 160 - MTHP 250

