



















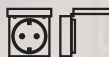

















Pictogramele capului de tabel

 Note, completări	 Autonomie (h)	 Culoare	 Lungimea circuitului aferent butonului
 I_{imptotal} 10/350 μ s Capacitate totală descărcare curent de trăsnet	I_n Curent nominal (A)	 \times LED Numărul de LED-uri (buc)	IP.. Grad de protecție
U_p Nivel de protecție	 I_{imp} 1P 10/350 μ s Capacitate descărcare curent de trăsnet	U_n Tensiune nominală (V)	I_n L-N 8/20 μ s Curent nominal de funcționare
I_{cn} EN60698 Capacitatea nominală de rupere a siguranțelor automate	U_c Tensiunea de ținere permanentă	I_{max} 8/20 μ s Curent maxim de descărcare	 Dimensiuni (LxWxH)
$I\Delta n$ (mA) Curent nominal rezidual	I_e Curent nominal de lucru	U_m Tensiunea nominală de acționare	 Secțiunea conductorului de racord
U_{up} Nivel superior de protecție al tensiunii	P_{max} Putere nominală	P_s Consum propriu	 NC NO CO Contacte
$\times P$ Număr de poli	U_{down} Nivel inferior de protecție al curentului	 C Caracteristica de declanșare	 Priză cu capac
I_{sec} Curent maxim în înfășurarea secundară	$\times 17.5$ Număr module	 Partea stângă al siguranței	Σ Numărul de butoane care se pot utiliza
 Contact de protecție lateral	U_{sec} Tensiune secundară	U_{pr} Tensiunea primară	
 Tipul de rețea	 Contact de protecție tip pin	 Priză normală	

Pictogramele datelor tehnice

230 V AC Tensiune nominală (V)	50/60 Hz Frecvența nominală	 Se poate monta pe tavan și pe pereții laterali	IP 54 Grad de protecție
 Volum (intensitate)	 rel % 30-90 Umiditate relativă	Ta 40..+105 °C Temperatura mediului ambiant	low batt Indicator de baterie descărcată
 Element modular înlocuibil	 Variantă constructivă compactă	AUX 1xNO Contacte auxiliare	[mm²] 0,75-2,5 Secțiunea conductorului de racord
Ft Siguranță termică	 Eclator	 Varistor	 Semnalizator optic
63 A gG Siguranța din amonte recomandată	I2t 3 Clasa de eficiență energetică	E3 Clasa de eficiență energetică	R $\geq 0.5m\Omega$ Rezistența
LCD Aparat de măsură cu afișaj digital	 Clasa II de protecție la atingere	AC Pentru rețele de curent alternativ	A, AC Pentru rețele de curent alternativ și de curent continuu pulsatoriu
U_{imp} 6 kV Tensiune nominală de ținere la impuls	 U_i 690 V Tensiunea nominală de izolare	 Durata de viață electrică $\times 10.000$	 Durata de viață mecanică $\times 10.000$
I_{cn} EN60698 10 kA Capacitatea nominală de rupere a siguranțelor automate	 Se poate monta pe pereții laterali	P_m 0,8 W Consum propriu	 Durata de viață [h] 20.000
 Se poate plomba în poziție 0-1-2	 OFF Se poate plomba în poziție oprită	8mm Distanța între contacte	V0 UL94 Rezistență la foc conform UL 94
 Se poate fixa pe sină de montaj 35x7.5	 Se pot interconecta prin intermediul șinelor de legătură tip pin	 Se pot interconecta prin intermediul șinelor de legătură tip pin sau tip furcă	 Tipul declanșatorului: Termic și magnetic



Descărcătoare de curent de trăsnet, clasa 1 4



Descărcătoare combinate de supratensiune (clasa 1+2) 4



Descărcătoare de supratensiune de clasa 2 5



Descărcătoare de supratensiune de clasa 2 pentru curent continuu 5

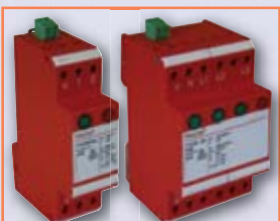

Descărcătoare de supratensiune de clasa 3 (protecție fină), variantă constructivă modulară 6



Descărcător de supratensiune, clasa 2+3 (pentru surse de alimentare LED) 6

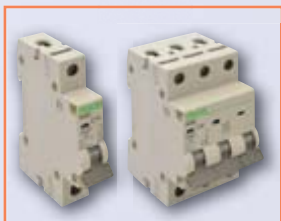

Sigurante automate, tip EVOZ 12

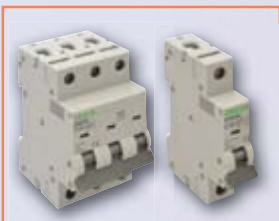

Sigurante automate, tip EVOTDA 13



Sigurante pentru cureni mari, tip EVOH 14



Sigurante automate, tip EVON 15



Disjunctoare cu protecție diferențială, tip EVOK 16



Blocuri cu protecție diferențială, tip EVOV 17

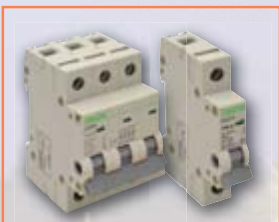

Întrerupătoare separatoare modulare, tip EVOTIK 19

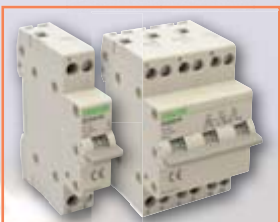

Selectoare modulare, tip EVOSVK 20



Întrerupător separator modular cu zăvorăre prin lacăt, tip EVOMS 21



Lămpi de semnalizare modulare, tip EVOSLJL 21



Buton modular, comutator modular, tip EVOP 22



Transformatoare de siguranță (pt. sonerii), tip EVOBT 22



Contactoare de instalații, tip EVOHK 23



Relee de recuperare automată la creșterea/scăderea tensiunii 24



Sigurante automate tip MB 27



Sigurante automate tip TDZ 28



Sigurante automate tip DC, pentru rețele electrice de curent continuu 29



Disjunctoare cu protecție diferențială KVK 31



Blocuri cu protecție diferențială RB 32



Bloc cu protecție diferențială combinat cu dispozitiv de recuperare automată cu motor 35



Automat de scară 37



Releu de impuls 38



Sonerii 38



Prize de tablou 39



Prize și întrerupătoare PT 40



Priză ST cu CP lateral, cu port USB 43



Sonerie pentru școală 43



Detector monoxid de carbon 44



Detector de fum fără fir cu posibilitatea de transmisie 45



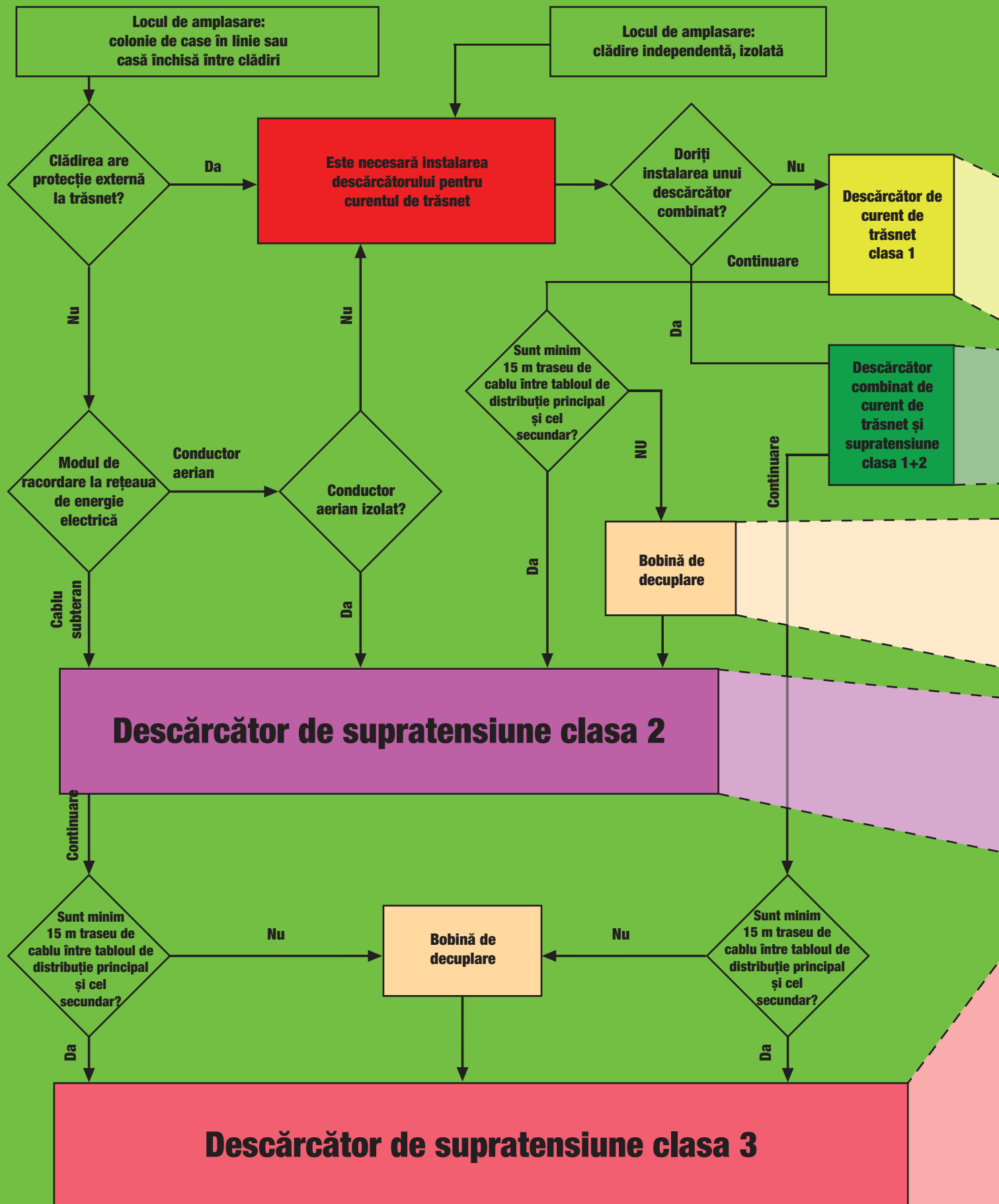

Ghid de selecție

La proiectarea corespunzătoare a sistemului de protecție la trăsnet și supratensiuni, din cauza complexității acesteia, recomandăm în toate cazurile ca fiecare beneficiar să solicite ajutorul unui specialist.

Diagrama atașată oferă ajutor pentru proiectare, urmată până la capăt se pot alege elementele componente ale sistemului pentru protecția rețelei electrice.

Diagrama trebuie începută din pătratul corespunzător locului de amplasare și în toate cazurile trebuie continuată până la descărcătorul de clasă 3. Pentru protecția minimală ar trebui instalate descărcătoarele de clasă 2 și 3. Descărcătoarele de clasă 1 și 1+2 se montează în general în tabloul de distribuție principal al clădirilor, iar descărcătoarele de clasă 2 și 3 se recomandă a se monta în tabloul de distribuție secundar. Dacă între descărcătorul de clasă 3 și echipamentul de protejat traseul de cablu este mai mare de 30 m, atunci protecția de clasă 3 trebuie repetată la bornele echipamentului ! Pentru protecția sistemelor de curenți slabi vă recomandăm prelungitoarele noastre cu protecție suplimentară.

Pentru o descriere mai detaliată consultați ANEXA

Descărcător de curent de trăsnet clasă 1



F/4

Descărcătoare DC



F/6

Bobină de decuplare



F/7

Descărcător combinat de curent de trăsnet și supratensiune clasă 1+2



F/4

Descărcător de supratensiune clasă 2



F/5

Descărcător de supratensiune clasă 3



F/6 - F/7

Prelungitoare cu mai multe prize - cu protecție



G/9 - G/10

Descărcătoare de curent de trăsnet, clasa 1

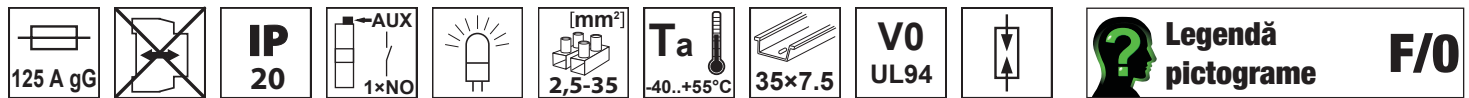

TRACON	xP	I _{imp} 1P 10/350µs	I _{imp} total Σ 10/350µs	U _n	U _p	U _c	W (mm)	
TTV1-50-1P	1P	25 kA	50 kA	230 V,			18	TN, TT
TTV1-50-2P	2P	25 kA	50 kA	50 Hz; 1~			36	TN, IT
TTV1-50-3P	3P	25 kA	50 kA	3x230/400 V, 50 Hz; 3~	0,9/1,5 kV	260 V, AC	54	TN, TT
TTV1-50-3P+N/PE	3P+N/PE	25 kA	50 kA				72	TN, TT
TTV1-50-4P	4P	25 kA	50 kA				72	TN, IT



RELEVANT STANDARD
EN 61643

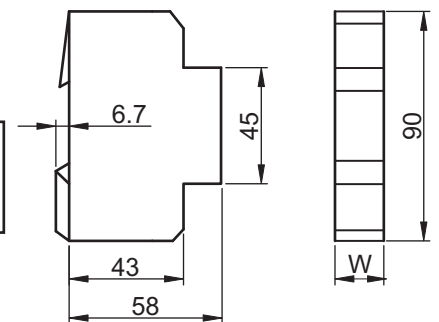

Aceste aparate sunt potrivite pentru descărcarea curenților de trăsnet cu energie mare datorată loviturilor de trăsnet cu forma de undă 10/350 µs din rețelele de alimentare, trifazate respectiv monofazate, cu conductoare neizolate. Variante constructive compacte (unitare cu soclul). Descărcătoarele de clasa 1 trebuie montate în tabloul principal de distribuție după prima protecție la s.c. și imediat după contorul de energie electrică.

Ghid de selecție vezi pag. F/2-3!

Descărcătoare combinate de supratensiune (clasa 1+2)

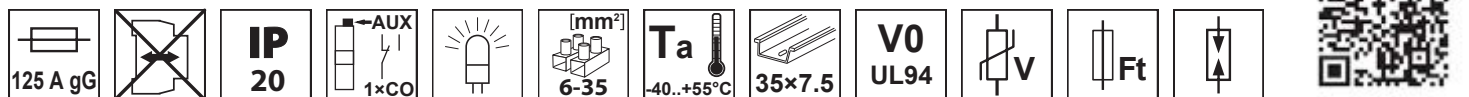

TRACON	xP	I _{imp} 1P 10/350µs	I _{max} 8/20µs	U _n	U _p	U _c	W (mm)	
TTV1+2-100-1P	1P	8 kA	100 kA	230/400 V, 50 Hz	2,2 kV	385 V AC, 500 V DC	27	TN, TT, IT
TTV1+2-100-2P	2P	8 kA	100 kA				54	TN, TT, IT
TTV1+2-100-3P	3P	8 kA	100 kA				81	TN, TT, IT
TTV1+2-100-4P	4P	8 kA	100 kA				108	TN, TT, IT
TTV1+2-100-3P+N/PE	3P+N/PE	8 kA	100 kA				108	TN, TT, IT
TTV1+2-80-1P	1	8 kA	80 kA	230/400 V, 50 Hz	2,2 kV	385 V AC, 500 V DC	27	TN, TT, IT
TTV1+2-80-2P	2	8 kA	80 kA				54	TN, TT, IT
TTV1+2-80-3P	3	8 kA	80 kA				81	TN, TT, IT
TTV1+2-80-4P	4	8 kA	80 kA				108	TN, TT, IT
TTV1+2-80-3P+N/PE	3P+N/PE	8 kA	80 kA				108	TN, TT, IT

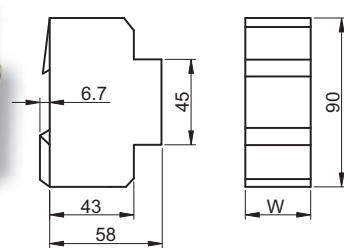

Aceste aparate sunt potrivite pentru descărcarea curenților de trăsnet cu energie mare datorată loviturilor de trăsnet cu forma de undă 10/350 µs și/sau supratensiunilor induse de supracurenții datorată comutației (forma de undă 8/20 µs), din rețelele de alimentare trifazate respectiv monofazate, cu conductoare neizolate. Variante constructive compacte (unitare cu soclul). Descărcătoarele de clasa 1.+2. trebuie montate în tabloul principal de distribuție după prima protecție la s.c. și imediat după contorul de energie electrică.

Atenție! În general capacitatea de descărcare a descărcătoarelor combinate nu ajunge la nivelul capacității de descărcare a celor distincte!

Cu o dimensionare corespunzătoare se pot utiliza și în sistemele fotovoltaice (DC)!

Ghid de selecție vezi pag. F/2-3!

Descărcătoare de supratensiune de clasa 2

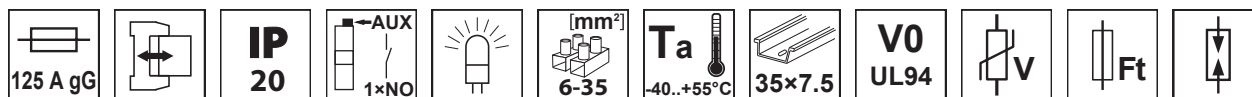

TRACON	xP	I _n L-N 8/20μs	I _{max} 8/20μs	U _n	U _p	U _c	W (mm)	
TTV2-60-1P	1P	30 kA	60 kA	230 V, 3x230/400 V	2,0 kV	385 V AC	18	TN, TT, IT
TTV2-60-2P	2P	30 kA	60 kA				36	TN, TT, IT
TTV2-60-3P	3P	30 kA	60 kA				54	TN, TT, IT
TTV2-60-3P+N/PE	3P+N/PE	30 kA	60 kA				72	TN, TT, IT
TTV2-60-4P	4P	30 kA	60 kA				72	TN, TT, IT
TTV2-40-1P	1P	20 kA	40 kA				1,8 kV	385 V AC
TTV2-40-2P	2P	20 kA	40 kA		36	TN, TT, IT		
TTV2-40-3P	3P	20 kA	40 kA		54	TN, TT, IT		
TTV2-40-3P+N/PE	3P+N/PE	20 kA	40 kA		72	TN, TT, IT		
TTV2-40-4P	4P	20 kA	40 kA		72	TN, TT, IT		
TTV2-30-1P+N/PE*	1P+N/PE	15 kA	30 kA		1,5 kV	320 V AC		
TTV2-30-3P+N/PE**	3P+N/PE	15 kA	30 kA				36	TN, TT, IT
TTV2-20-1P	1P	10 kA	20 kA	1,5 kV	385 V AC	18	TN, TT, IT	
TTV2-20-2P	2P	10 kA	20 kA			36	TN, TT, IT	
TTV2-20-3P	3P	10 kA	20 kA			54	TN, TT, IT	
TTV2-20-3P+N/PE	3P+N/PE	10 kA	20 kA			72	TN, TT, IT	
TTV2-20-4P	4P	10 kA	20 kA			72	TN, TT, IT	

* 2 descărcătoare într-un aparat cu lățime de un modul pentru rețele monofazate de tip TNC-S și TNS

** 4 descărcătoare într-un aparat cu lățime de 2 de module pentru rețele trifazate de tip TNC-S și TNS

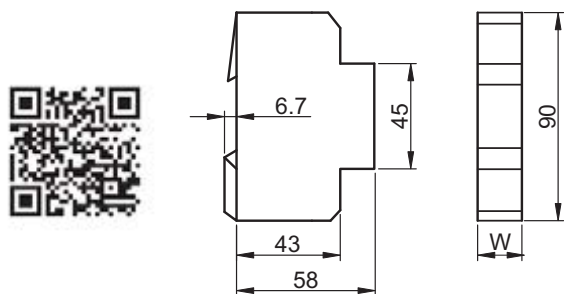

Aceste aparate sunt adecvate descărcării supratensiunilor induse de supracurenții datorati comutației (forma de unda 8/20μs).

Descărcătoarele de tip 2 trebuie montate în tabloul de distribuție secundar după tabloul de distribuție principal care conține descărcătoarele de tip 1. (în clădirile cu mai multe apartamente în tablourile de distribuție de palier). În scopul unei funcționări corespunzătoare între descărcătoarele de tip 1 și cele de tip 2 trebuie să fie minim 10-15 metri lungime de traseu de conductor sau trebuie să se intercaleze o bobină de decuplare. Variante constructive cu element modular înlocuibil. Contactul auxiliar este încorporat în soclu.

Socli + Elemente modulare

TRACON	I _n L-N 8/20μs	I _{max} 8/20μs	W (mm)	TTV2-BASE-1P	TTV2-BASE-2P	TTV2-BASE-3P	TTV2-BASE-4P
TTV2-60-M	30 kA	60 kA	18	-	OK	OK	OK
TTV2-40-M	20 kA	40 kA	18	OK	-	-	-
TTV2-30-A-M*	15 kA	30 kA	18	-	-	-	-
TTV2-30-B-M**	15 kA	30 kA	18	-	-	-	-
TTV2-20-M	10 kA	20 kA	18	OK	-	-	-
TTV2-40-N/PE-M	20 kA	40 kA	18	-	OK	OK	OK

*element modular 2P pentru descărcătorul TTV2-30-3P+N/PE

** element modular 1P+N/PE pentru descărcătorul TTV2-30-1P+N/PE și TTV2-30-3P+N/PE



TTV2-20-M



TTV2-40-N/PE-M

Descărcătoare de supratensiune de clasa 2 pentru curent continuu

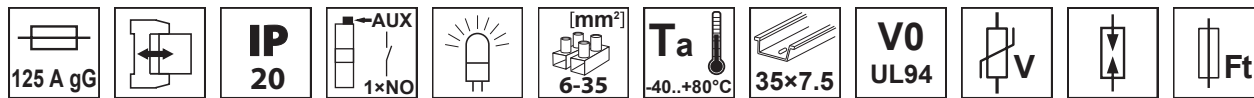

TRACON	xP	U_n	U_p	U_c	I_n L-N 8/20µs	I_{max} 8/20µs
TTV2-40-DC-600	3 P	600 V DC	3 kV	800 V DC	20 kA	40 kA
TTV2-40-DC-1000	3 P	1000 V DC	4 kV	1200 V DC	20 kA	40 kA



Elemente modulare

TRACON	I_n L-N 8/20µs	I_{max} 8/20µs	U_p
TTV2-40-DC-600-M	20 kA	40 kA	3 kV
TTV2-40-DC-1000-M	20 kA	40 kA	4 kV
TTV2-40-DC-600-V	20 kA	40 kA	3 kV
TTV2-40-DC-1000-V	20 kA	40 kA	4 kV
TTV2-40-DC-600-G	20 kA	40 kA	3 kV
TTV2-40-DC-1000-G	20 kA	40 kA	4 kV

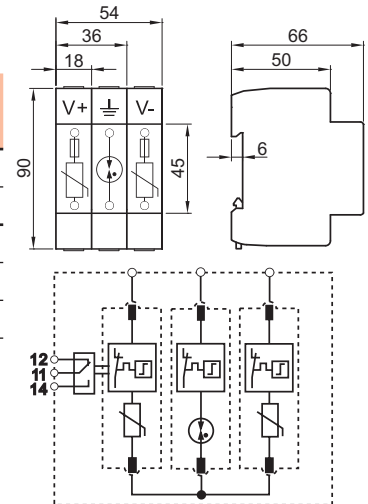

RELEVANT STANDARD
EN 61643

Aceste aparate sunt adecvate descărcării supratensiunilor induse de supracurenții datorati comutației (forma de unda **8/20 µs**).

Descărcătoarele de supratensiune de clasa 2 pentru curent continuu au fost proiectate în special pentru utilizarea în circuitele de curent continuu a sistemelor fotovoltaice (PV).

Variante constructive cu element modular înlocuibil. Contactul auxiliar este încorporat în soclu.

Descărcătoare de supratensiune de clasa 3 (protecție fină), variantă constructivă modulară

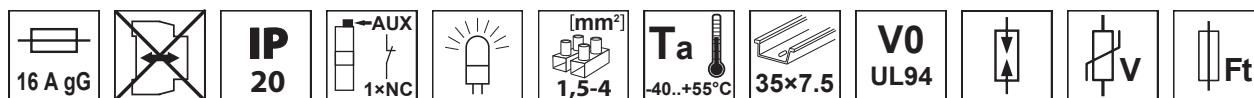

TRACON	xP	I_n L-N 8/20µs	I_{max} 8/20µs	U_n	U_p	U_c	W (mm)	
TTV3-10-1P+N/PE	1P+N/PE	5 kA	10 kA	230 V, 50 Hz; 1~	1,5 kV	385/440 V	36	TN, TT
TTV3-10-3P+N/PE	3P+N/PE	5 kA	10 kA	3x230/400 V, 50 Hz; 3~	1,5 kV	385/440 V	72	TN, IT



RELEVANT STANDARD
EN 61643

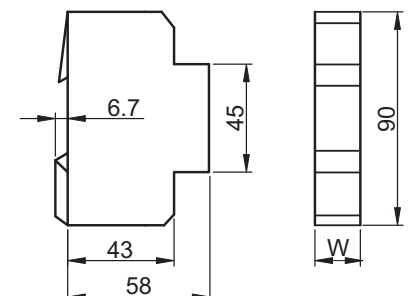

Descărcătoarele de clasa 3 trebuie montate pe cât posibil cât mai aproape de aparatul de protejat.

Unitățile secundare de protecție la trăsnet care limitează și întrerup vârfurile de tensiune datorate comutației din rețea pentru ca perturbațiile de supratensiune să nu se propage, prin conductoarele de alimentare cu energie electrică, la echipamentele electronice producând defectarea acestora. Variante constructive compacte (element modular unitar cu soclu).

Atenție! Ca aparat de protecție singular, independent, nu poate rezolva protecția la supratensiuni de trăsnet a echipamentelor!

Variantele constructive monofazate și trifazate care se pot monta în tablourile de distribuție se pot conecta în paralel sau în serie cu aparatul de protejat. În cazul conectării în serie, descărcătoarele trebuie instalate după protecția la supracurent.

Descărcătoare de supratensiune de clasa 3 (protecție fină), varianta constructivă încorporabilă

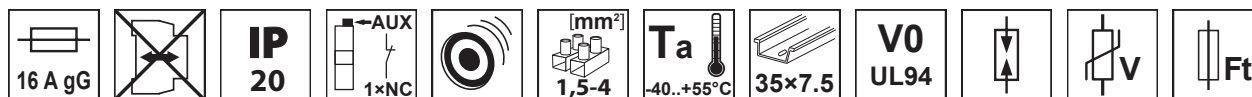

TRACON	$\times P$ 1P+N-PE	I_n L-N 8/20 μ s	I_{max} 8/20 μ s	U_n	U_p	U_c	
TTV3-5-1P+N-PE	1P+N-PE	2,5 kA	5 kA	230 V, 50 Hz; 1~	1,25 kV	255 V AC	TN, IT

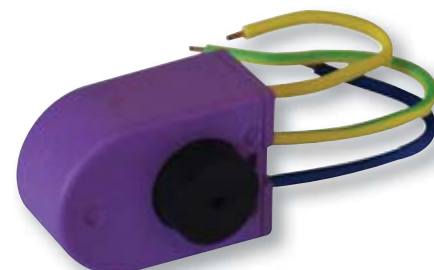
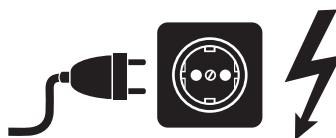
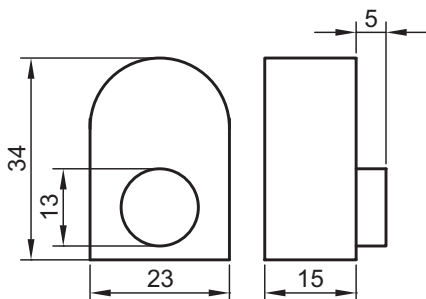

Descărcătoarele de clasa 3 trebuie montate pe cât posibil cât mai aproape de aparatul de protejat.

Unitățile secundare de protecție la trăsnet care limitează și întrerup vârfurile de tensiune datorate comutației din rețea pentru ca perturbațiile de supratensiune să nu se propage, prin conductoarele de alimentare cu energie electrică, la echipamentele electronice producând defectarea acestora. Atenție! Ca aparat de protecție singular, independent, nu poate rezolva protecția la supratensiuni de trăsnet a echipamentelor!

Descărcător de supratensiune, clasa 2+3 (pentru surse de alimentare LED)

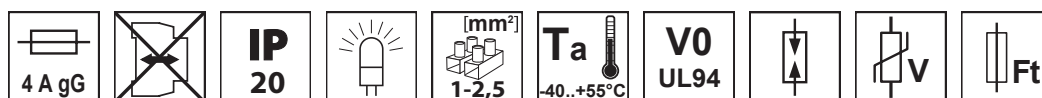

TRACON	I_n L-N 8/20 μ s	I_{max} 8/20 μ s	U_n	U_p	U_c	
TTVL2+3-10	5 kA	10 kA	230 V, 50 Hz	1,5 kV	320 V AC	TN, IT



Descărcătorul de supratensiune compact TTVL2+3-10 servește pentru protecția surselor de alimentare LED. Descărcătorul de supratensiuni LED protejează sursele de alimentare monofazate cu tensiunea de 120-277 V.c.a. împotriva supratensiunilor tranzitorii cauzate de trăsnete și de comutație.

Defecțiunea este indicată prin aprinderea unei lumini de semnalizare pe aparat.

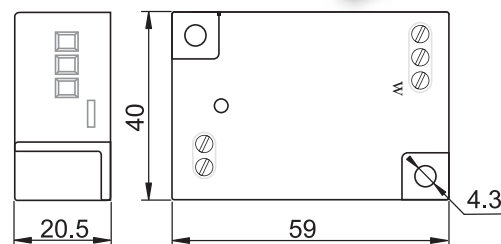

Bobină de decuplare

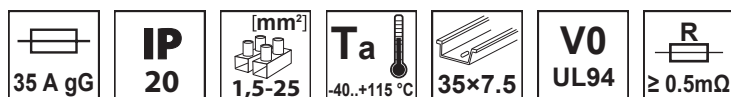

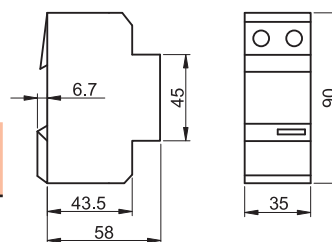

TRACON	$\times 17.5$ 2	I_n	U_n	L
TTV-CSF35	2	35 A	500 V AC/DC	18 μ H \pm 10 %



Condiția esențială a funcționării coordonate a descărcătorului de curent de trăsnet de clasa 1 din sistemul complex de protecție la supratensiune și a descărcătorului de supratensiuni de clasa 2 care urmează după el, este ca între descărcătoare să se intercaleze o bobină cu impedanță corespunzătoare, pentru formarea diferitelor niveluri de tensiune aferente fiecărei clase. Această condiție este îndeplinită în general atunci când între cele două dispozitive de protecție este cel puțin 10-15 m traseu de conductor.



Siguranțe automate

TRACON			I_n	I_{cn} EN60698	
EVON	C	1+N	6 – 32 A	4,5 kA	F/15
EVOZ	B, C	1, 2, 3, 4	1 – 63 A	6 kA	F/12.
EVOTDA	B, C	1, 2, 3, 4	1 – 63 A	10 kA	F/13.
EVOH	C	1, 2, 3, 4	63 – 125 A	10 kA	F/14.
DPN	C	1+N	6 – 32 A	4,5 kA	F/26.
MB	B, C	1, 2, 3	6 – 63 A	4,5 kA	F/27.
TDZ	B, C, D	1, 2, 3, 4	1 – 63 A	6 kA	F/28.
DC	C	1, 2, 3, 4	6 – 63 A	6/10 kA	F/29.
KMH	C	1, 2, 3, 4	63 – 125 A	6 kA	F/30.

Siguranțele automate se utilizează la protecția circuitelor electrice de suprasarcini, prevenirea defecțiunilor cauzate de scurtcircuite. Asigură respectarea normelor de securitatea muncii și protecția mediului. Declanșarea poate fi realizată cu bimetale (la suprasarcini), declanșator instantaneu electromagnetic (scurtcircuite) sau manual. Acționarea polilor se face în același timp.

Caracteristici de declanșare

Norma EN 60898 determină caracteristicile de funcționare, cerințele structurale, precum și testele de efectuat.

În domeniul de suprasarcină ($< 2,55 \times I_n$) toate curbele caracteristice (B, C și D) au aceeași alură. Diferențele apar în zona $> 3 \times I_n$, unde declanșarea se produce în domeniul $(3 - 5) \times I_n$ pentru tipul B, $(5 - 10) \times I_n$ pentru tipul C, respectiv $(10 - 15) \times I_n$ pentru tipul D.

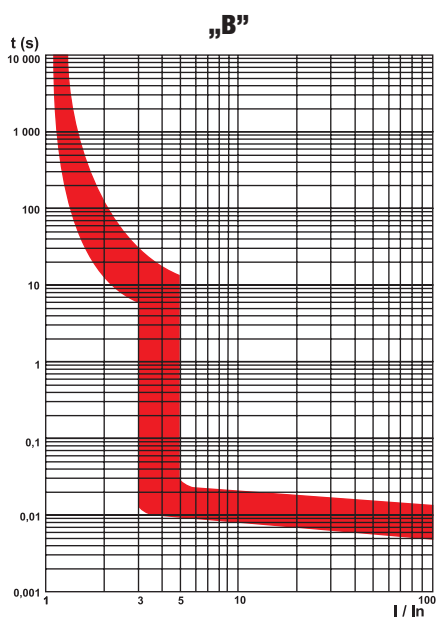

De uz general, pentru protecția consumatorilor cu curent de pornire mic, în circuite cu becuri incandescente și pentru protecția conductorilor.

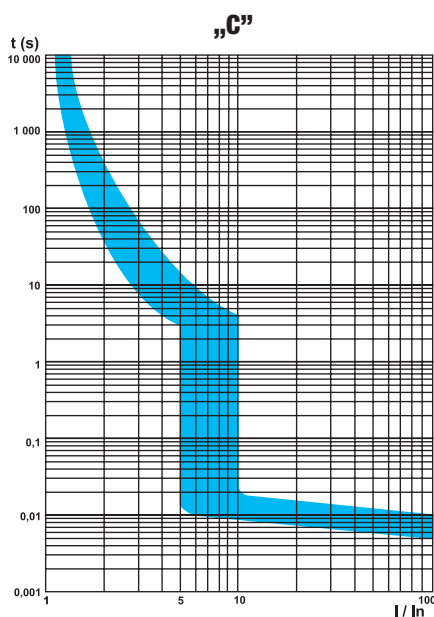

De uz general, pentru protecția aparatelor electrocasnice și a motoarelor mici.

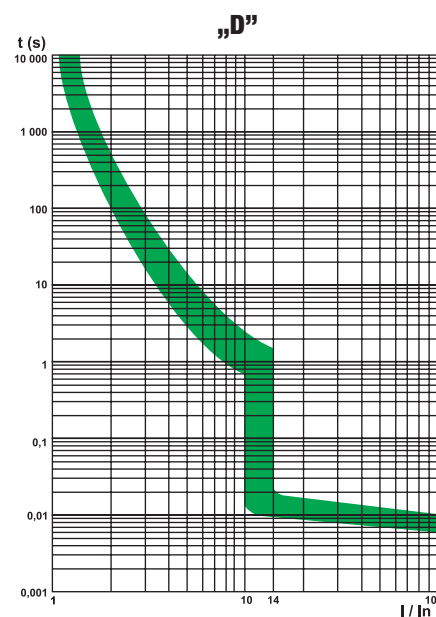

Pentru protecția motoarelor cu curent mare la pornire, transformatoarelor și altor consumatori cu caracter inductiv.

Date dependente de temperatură

Sarcina maximă admisă pe siguranțe scade în raport cu temperatura mediului.

Când se face dimensionarea siguranțelor, în situația în care se montează mai multe siguranțe una lângă alta într-un tablou, trebuie luat în calcul creșterea temperaturii din interiorul tabloului.





De exemplu: Sarcina maximă la o siguranță cu curentul nominal de 16A ($I_n = 16A$) poate fi de 17,9A la 20 °C, la 40 °C sarcina este chiar sarcina nominală de 16A iar la 60 °C valoarea sarcinii scade la 13,9A.

Temperatura de referință pentru funcționarea siguranțelor automate este 40 °C.

Curentul de sarcină, maxim admisibil (A)

I_n (A)	20 °C	30 °C	40 °C	50 °C	60 °C
2	2.18	2.08	2	1.9	1.8
4	4.52	4.24	4	3.72	3.44
6	6.48	6.24	6	5.76	5.46
10	11.4	10.7	10	9.2	8.4
16	17.9	16.9	16	15	13.9
20	22.2	21.2	20	18.8	17.6
25	27.7	26.5	25	23.5	21.7
32	35.2	33.6	32	30.4	28.4
40	44.4	42.4	40	37.5	34.8
50	56	53	50	46.5	43
63	71.8	67.4	63	57.9	52.9

Disjunctoare cu protecție diferențială

TRACON				I_n (A)	I_{cn} EN60698	
EVOKE	B, C	2	1	6 – 32 A	6 kA	F/15.
EVOK	B, C	2	1	6 – 32 A	6 kA	F/16.
EVOKM	B, C	2	1	6 – 32 A	6 kA	F/16.
KVKE	B, C	2	1	6 – 32 A	6 kA	F/31.
KVK	B, C	2	2	6 – 32 A	3 kA	F/31.
KVKM	B, C	2	2	6 – 40 A	6 kA	F/32.

Disjunctoarele cu protecție combinată sunt aparate utilizate în primul rând în instalația electrică a clădirilor. Asigură protecția persoanelor împotriva electrocutării, protecția împotriva suprasarcinii și a scurtcircuitelor.

Sunt potrivite mai ales în circuitele acelor încăperi unde dorim să creem siguranță mărită (de ex. camere de copii, saloane de spital, e.t.c.)

Pornind de la dimensiunile de gabarit, în caz de modificare ulterioară a cerințelor se poate monta simplu în locul siguranțelor automate existente.

Pentru asigurarea celor 3 funcții în carcasa comună sunt plasate transformatorul sumator al blocului diferențial, declanșatorul electromagnet instantaneu la scurtcircuit

și declanșatorul termic cu bimetal la suprasarcină. Funcția de protecție diferențială a





aparaturii se verifică prin apăsarea butonului de testare „T”.

Verificarea trebuie efectuată în fiecare lună.

În scopul asigurării unei funcționări corespunzătoare, trebuie respectate marcasele bornelor, în momentul realizării legăturilor!



Blocuri cu protecție diferențială

TRACON			I_n (A)	$I_{\Delta n}$ (mA)	I_{cn} EN60698	
EVOV		2, 4	25, 40, 63, 80	30, 100, 300	6 kA	F/17.
RB		2, 4	25, 40, 63	30, 100, 300, 500	4,5 kA	F/32.
TFV		2, 4	16, 25, 40, 63	30, 100, 300	6 kA	F/33.
TFVH		4	80, 100, 125	30, 100, 300	6 kA	F/33.
EVOG		2, 4	25, 40, 63, 80	30, 100, 300	6 kA	F/18.
TFG		2, 4	16, 25, 40, 63	30, 100, 300	6 kA	F/34.
TFGA		–	16	30	6 kA	F/34.
TFIG		2, 4	16, 25, 40, 63, 80	30, 100, 300	10 kA	F/35.

TRACON	Denumire	EVOV	EVOG	RB	TFV	TFVH	TFG	TFIG
EDS-□, EDFK-□	cutii de distribuție	✓	✓	✓	✓	✓	✓	✓
TFSS-□	șine de legătură cu pin	✓	✓	✓	✓	✓	✓	✓
TFSS-□V	șine de legătură cu furcă	✓	✓	✓	✓	✓	✓	✓
TFSS-1CS	Clemă de conexiune cu șurub	✓	✓	✓	✓	✓	✓	–
35/7,5□SIN	șină omega EN50022	✓	✓	✓	✓	✓	✓	✓

Blocurile cu protecție diferențială sunt cele mai moderne soluții pentru protecție împotriva electrocutării prin atingere indirectă, uneori chiar și directă, în circuite cu pământare. Blocul diferențial decuplează în momentul când în circuit valoarea curentului rezidual atinge valoarea critică (izolație deteriorată sau atingere accidentală). Utilizarea sa este recomandată în toate circuitele electrice, dar este obligatorie în cazul circuitelor de alimentare al prizelor în aer liber, schele de construcții, betoniere, vane de baie cu bule de aer și multe altele. Peste valori de 6000A al curentului de scurtcircuit se utilizează siguranțe fuzibile.



FAMILIA MODULARĂ DE PRODUSE EVO



**Siguranțe automate,
6 kA-10 kA**



F/12

**Siguranțe automate,
1+N**



F/15

**Disjunctoare cu pro-
tecție diferențială**



F/15

**Blocuri cu protecție
diferențială**



F/17

**Înterupătoare sepa-
ratoare modulare**



F/19

**Selectoare
modulare**



F/20

**Înterupător separator mo-
dular cu zăvorâre prin lacăt**



F/21

**Lămpi de semnaliza-
re modulare**



F/21

**Butoane
modulare**



F/22

**Transformatoare de
siguranță (pt. sonerii)**



F/22

**Contactoare de
instalații**



F/23

**Relee de recuplare
automate**



F/24

Căutați noutățile în magazinul nostru virtual.

Contacte auxiliare și indicatoare declanșare

230/400 V AC	x5.000	x4.000	IP 20	35x7.5	[mm ²] 0,5-4	Ta -25..+55°C	U _i 500 V	V0 UL94
-----------------	--------	--------	--------------	--------	-----------------------------	----------------	-------------------------	-------------------

Legendă pictograme **F/0**

TRACON		I _n (A) 400 V AC	I _n (A) 230 V AC	I _n (A) 110 V DC	I _n (A) 48 V DC	I _n (A) 24 V DC
EVOZ-AUX11	EVOZ					
EVOH-AUX11	EVOH					
EVOTDA-AUX11	EVOTDA					
EVOZ-AL	EVOZ	3 A	6 A	1 A	2 A	4 A
EVOH-AL	EVOH					
EVOTDA-AL	EVOTDA					

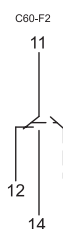
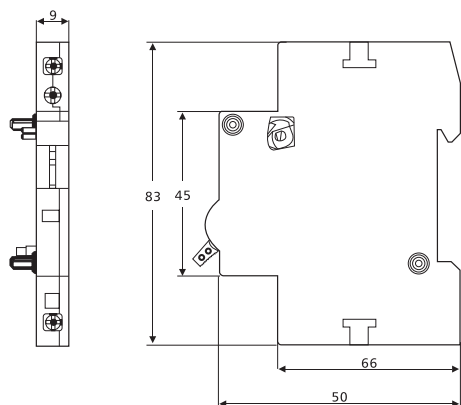

Declanșator la tensiune de lucru, declanșator la variații de tensiune

230/400 V AC	x4.000	x3.000	IP 20	35x7.5	[mm ²] 0,5-4	Ta -25..+55°C	U _i 500 V	V0 UL94
-----------------	--------	--------	--------------	--------	-----------------------------	----------------	-------------------------	-------------------



TRACON		U _s		
EVOZ-SR*	EVOZ	110-415V AC / 110-220V DC	-	-
EVOH-SR*	EVOH	110-415V AC / 110-220V DC	-	-
EVOTDA-SR*	EVOTDA	110-415V AC / 110-220V DC	-	-
EVOZ-OVR	EVOZ	-	280V ± 5%	-
EVOZ-UVR	EVOZ	-	-	170V ± 5%
EVOH-OVR	EVOH	-	280V ± 5%	-
EVOH-UVR	EVOH	-	-	170V ± 5%
EVOTDA-OVR	EVOTDA	-	280V ± 5%	-
EVOTDA-UVR	EVOTDA	-	-	170V ± 5%

*declanșator la tensiune de lucru

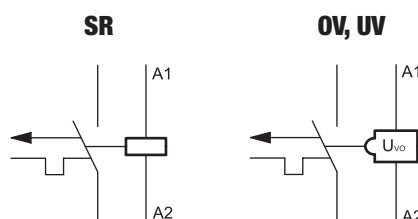
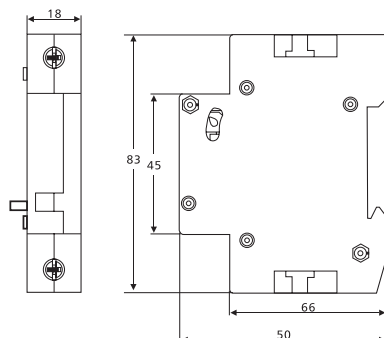

Siguranțe automate, tip EVOZ

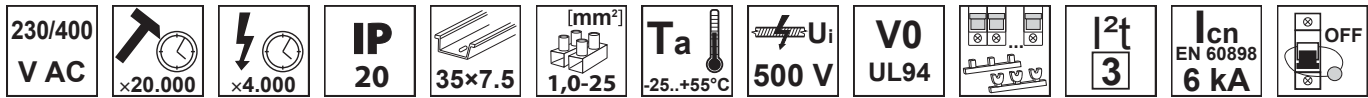

TRACON		I _n (A)
B	C	
EVOZ1B1	EVOZ1C1	1
EVOZ1B2	EVOZ1C2	2
EVOZ1B4	EVOZ1C4	4
EVOZ1B6	EVOZ1C6	6
EVOZ1B10	EVOZ1C10	10
EVOZ1B13	EVOZ1C13	13
EVOZ1B16	EVOZ1C16	16
EVOZ1B20	EVOZ1C20	20
EVOZ1B25	EVOZ1C25	25
EVOZ1B32	EVOZ1C32	32
EVOZ1B40	EVOZ1C40	40
EVOZ1B50	EVOZ1C50	50
EVOZ1B63	EVOZ1C63	63
EVOZ2B1	EVOZ2C1	1
EVOZ2B2	EVOZ2C2	2
EVOZ2B4	EVOZ2C4	4
EVOZ2B6	EVOZ2C6	6
EVOZ2B10	EVOZ2C10	10
EVOZ2B13	EVOZ2C13	13
EVOZ2B16	EVOZ2C16	16
EVOZ2B20	EVOZ2C20	20
EVOZ2B25	EVOZ2C25	25
EVOZ2B32	EVOZ2C32	32
EVOZ2B40	EVOZ2C40	40
EVOZ2B50	EVOZ2C50	50
EVOZ2B63	EVOZ2C63	63

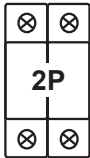

TRACON		I _n (A)
B	C	
EVOZ3B1	EVOZ3C1	1
EVOZ3B2	EVOZ3C2	2
EVOZ3B4	EVOZ3C4	4
EVOZ3B6	EVOZ3C6	6
EVOZ3B10	EVOZ3C10	10
EVOZ3B13	EVOZ3C13	13
EVOZ3B16	EVOZ3C16	16
EVOZ3B20	EVOZ3C20	20
EVOZ3B25	EVOZ3C25	25
EVOZ3B32	EVOZ3C32	32
EVOZ3B40	EVOZ3C40	40
EVOZ3B50	EVOZ3C50	50
EVOZ3B63	EVOZ3C63	63
EVOZ4B1	EVOZ4C1	1
EVOZ4B2	EVOZ4C2	2
EVOZ4B4	EVOZ4C4	4
EVOZ4B6	EVOZ4C6	6
EVOZ4B10	EVOZ4C10	10
EVOZ4B13	EVOZ4C13	13
EVOZ4B16	EVOZ4C16	16
EVOZ4B20	EVOZ4C20	20
EVOZ4B25	EVOZ4C25	25
EVOZ4B32	EVOZ4C32	32
EVOZ4B40	EVOZ4C40	40
EVOZ4B50	EVOZ4C50	50
EVOZ4B63	EVOZ4C63	63

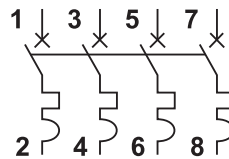
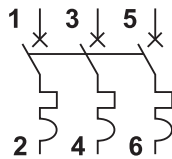
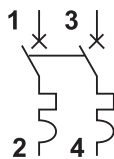
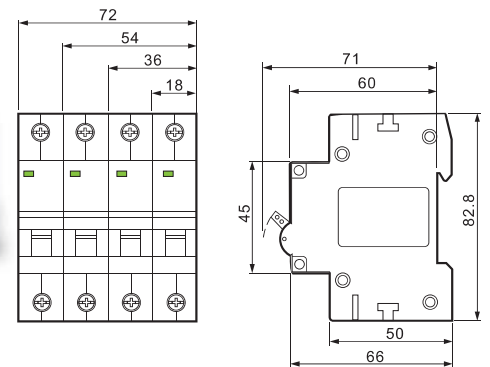
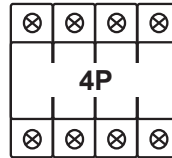
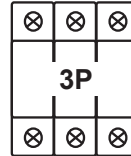

RELEVANT STANDARD
EN 60898-1

RELEVANT STANDARD
EN 60947-2



Siguranțe automate, tip EVOTDA

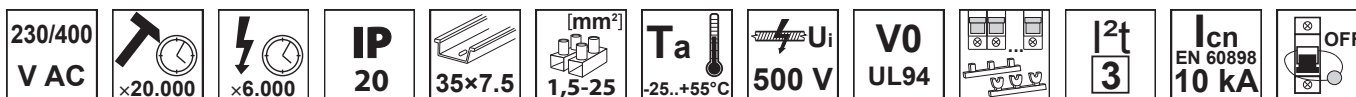

TRACON		I _n (A)
B	C	
TDA-1B-1	TDA-1C-1	1
TDA-1B-2	TDA-1C-2	2
TDA-1B-4	TDA-1C-4	4
TDA-1B-6	TDA-1C-6	6
TDA-1B-10	TDA-1C-10	10
TDA-1B-13	TDA-1C-13	13
TDA-1B-16	TDA-1C-16	16
TDA-1B-20	TDA-1C-20	20
TDA-1B-25	TDA-1C-25	25
TDA-1B-32	TDA-1C-32	32
TDA-1B-40	TDA-1C-40	40
TDA-1B-50	TDA-1C-50	50
TDA-1B-63	TDA-1C-63	63
<hr/>		
TDA-2B-1	TDA-2C-1	1
TDA-2B-2	TDA-2C-2	2
TDA-2B-4	TDA-2C-4	4
TDA-2B-6	TDA-2C-6	6
TDA-2B-10	TDA-2C-10	10
TDA-2B-13	TDA-2C-13	13
TDA-2B-16	TDA-2C-16	16
TDA-2B-20	TDA-2C-20	20
TDA-2B-25	TDA-2C-25	25
TDA-2B-32	TDA-2C-32	32
TDA-2B-40	TDA-2C-40	40
TDA-2B-50	TDA-2C-50	50
TDA-2B-63	TDA-2C-63	63

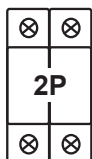
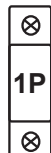

TRACON		I _n (A)
B	C	
TDA-3B-1	TDA-3C-1	1
TDA-3B-2	TDA-3C-2	2
TDA-3B-4	TDA-3C-4	4
TDA-3B-6	TDA-3C-6	6
TDA-3B-10	TDA-3C-10	10
TDA-3B-13	TDA-3C-13	13
TDA-3B-16	TDA-3C-16	16
TDA-3B-20	TDA-3C-20	20
TDA-3B-25	TDA-3C-25	25
TDA-3B-32	TDA-3C-32	32
TDA-3B-40	TDA-3C-40	40
TDA-3B-50	TDA-3C-50	50
TDA-3B-63	TDA-3C-63	63
<hr/>		
TDA-4B-1	TDA-4C-1	1
TDA-4B-2	TDA-4C-2	2
TDA-4B-4	TDA-4C-4	4
TDA-4B-6	TDA-4C-6	6
TDA-4B-10	TDA-4C-10	10
TDA-4B-13	TDA-4C-13	13
TDA-4B-16	TDA-4C-16	16
TDA-4B-20	TDA-4C-20	20
TDA-4B-25	TDA-4C-25	25
TDA-4B-32	TDA-4C-32	32
TDA-4B-40	TDA-4C-40	40
TDA-4B-50	TDA-4C-50	50
TDA-4B-63	TDA-4C-63	63

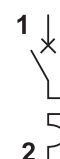
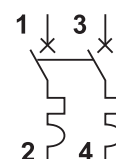
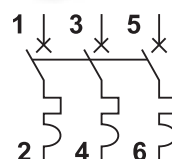
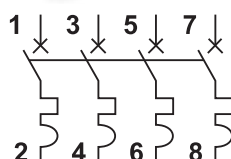
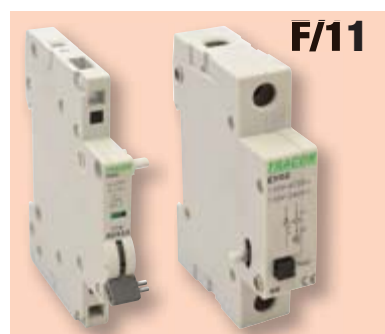
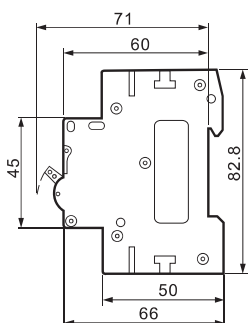
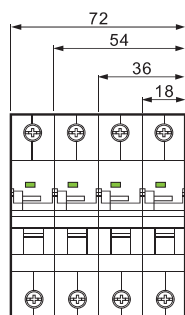
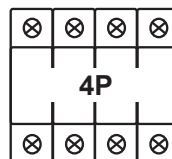
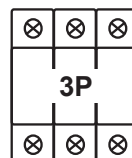

RELEVANT STANDARD
EN 60898

Legendă pictograme F/0



Siguranțe pentru curenți mari, tip EVOH

230/400 V AC	$\times 20.000$	$\times 10.000$	IP 20	35x7.5	[mm ²] 16-50	Ta -25..+55°C	U_i 500 V	V0 UL94		12t 3	I_{cn} EN 60898 10 kA	
-----------------	-----------------	-----------------	-----------------	--------	-----------------------------	-------------------------	----------------	-------------------	--	-----------------	--	--

TRACON

I_n
(A)

TRACON

I_n
(A)



EVOH163	63
EVOH180	80
EVOH1100	100
EVOH1125	125

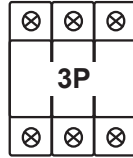

EVOH363	63
EVOH380	80
EVOH3100	100
EVOH3125	125

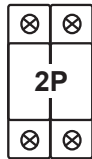

EVOH263	63
EVOH280	80
EVOH2100	100
EVOH2125	125

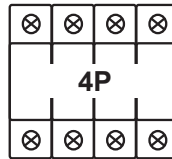

EVOH463	63
EVOH480	80
EVOH4100	100
EVOH4125	125

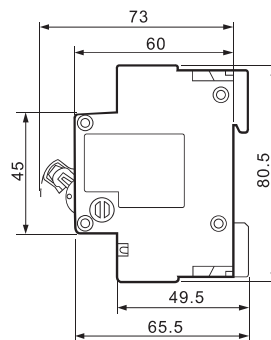
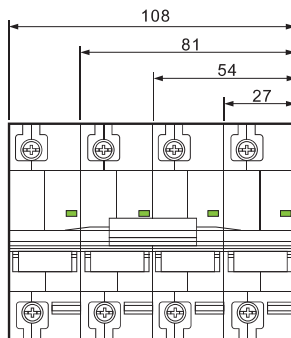
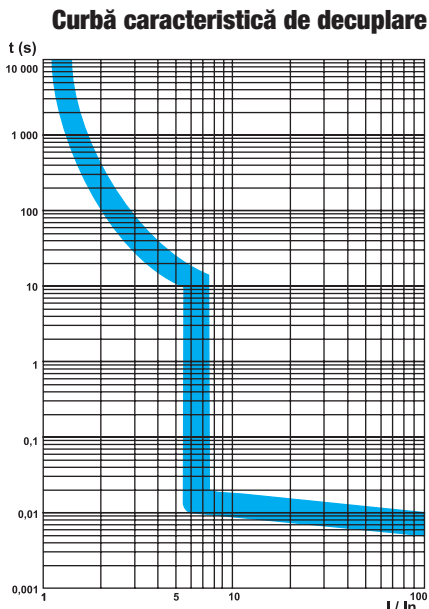
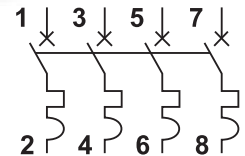
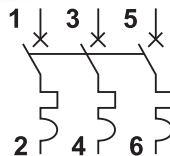

**RELEVANT STANDARD
EN 60898**



Siguranțe automate, tip EVON

230 V AC	x20.000	x4.000	IP 20	35x7.5	[mm ²] 1,0-10	Ta -25..+55°C	U _i 500 V	V0 UL94		12t 3	I _{cn} EN 60898 4,5 kA	
----------	---------	--------	-------	--------	---------------------------	----------------	----------------------	---------	--	----------	---------------------------------	--

TRACON		I _n (A)

⊗	⊗
1P	N
⊗	⊗

EVONC6	6
EVONC10	10
EVONC16	16
EVONC20	20
EVONC25	25
EVONC32	32

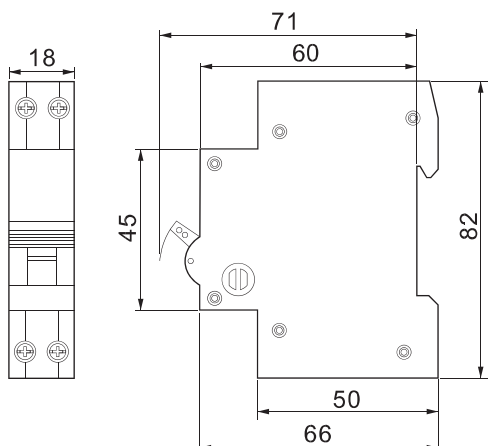
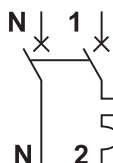

* Siguranță cu doi poli care protejează faza și comută nului.

RELEVANT STANDARD
EN 60898-1

Legendă pictograme **F/0**

Disjunctoare cu protecție diferențială, 1 modul lățime, tip EVOKE

230 V AC	x10.000	x4.000	IP 20	35x7.5	[mm ²] 1-16	Ta -25..+40°C	U _i 690 V	V0 UL94		AC	I _{cn} EN 60898 6 kA	
----------	---------	--------	-------	--------	-------------------------	----------------	----------------------	---------	--	----	-------------------------------	--

TRACON			
		I _n (A)	I _{Δn} (mA)
EVOKEB603	EVOKEC603	6	30
EVOKEB1003	EVOKEC1003	10	30
EVOKEB1603	EVOKEC1603	16	30
EVOKEB2003	EVOKEC2003	20	30
EVOKEB2503	EVOKEC2503	25	30
EVOKEB3203	EVOKEC3203	32	30

⊗	⊗
2P	
⊗	⊗

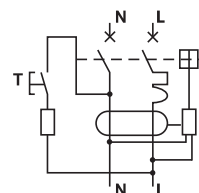

Caracteristici de decuplare

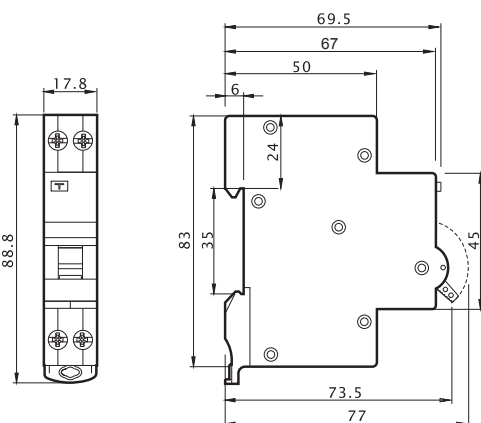
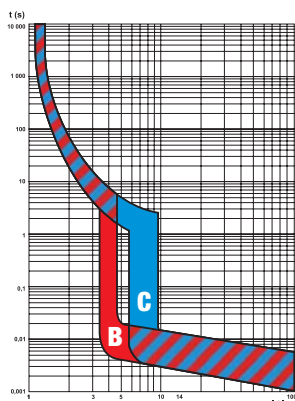

E3

RELEVANT STANDARD
EN 61009-1

Disjunctoare cu protecție diferențială, tip EVOK

230 V AC	$\times 10.000$	$\times 4.000$	IP 20	35x7.5	[mm ²] 1,5-25	Ta -25..+40°C	690 V	UL94	AC	Icn EN 60898 6 kA	OFF
----------	-----------------	----------------	-------	--------	---------------------------	---------------	-------	------	----	-------------------	-----



Caracteristici de decuplare

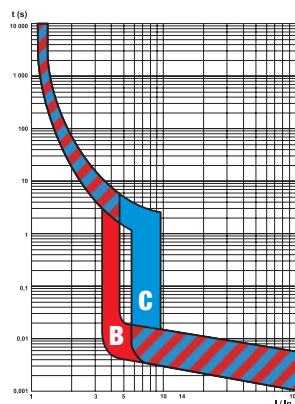

TRACON		In (A)	IΔn (mA)
B	C		
EVOK2B603	EVOK2C603	6	30
EVOK2B1003	EVOK2C1003	10	30
EVOK2B1603	EVOK2C1603	16	30
EVOK2B2003	EVOK2C2003	20	30
EVOK2B2503	EVOK2C2503	25	30
EVOK2B3203	EVOK2C3203	32	30
EVOK2B4003	EVOK2C4003	40	30

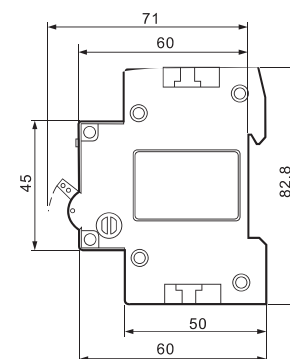
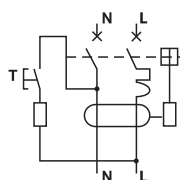

RELEVANT STANDARD EN 61009-1



Legendă pictograme **F/0**

E3

Disjunctoare cu protecție diferențială, electromecanice, tip EVOKM

230 V AC	$\times 10.000$	$\times 4.000$	IP 20	35x7.5	[mm ²] 1,5-25	Ta -25..+55°C	690 V	UL94	AC	Icn EN 60898 6 kA	OFF
----------	-----------------	----------------	-------	--------	---------------------------	---------------	-------	------	----	-------------------	-----



Caracteristici de decuplare

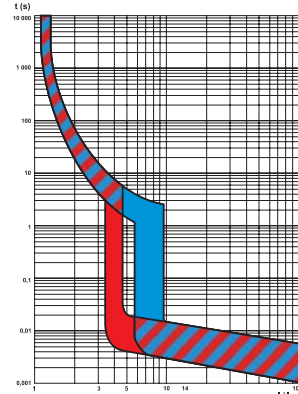

TRACON		In (A)	IΔn (mA)
B	C		
EVOKM2B603	EVOKM2C603	6	30
EVOKM2B1003	EVOKM2C1003	10	30
EVOKM2B1603	EVOKM2C1603	16	30
EVOKM2B2003	EVOKM2C2003	20	30
EVOKM2B2503	EVOKM2C2503	25	30
EVOKM2B3203	EVOKM2C3203	32	30
EVOKM2B4003	EVOKM2C4003	40	30
EVOKM2B5003	EVOKM2C5003	50	30
EVOKM2B6303	EVOKM2C6303	63	30

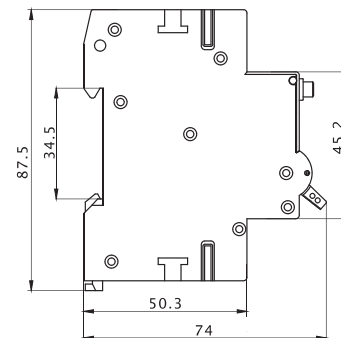
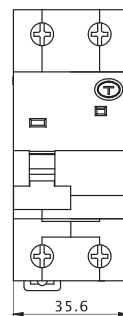
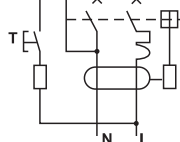
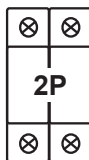

RELEVANT STANDARD EN 61009-1



Înterupătoarele electromecanice cu protecție combinată oferă protecție împotriva electrocutării și în cazul întreruperii conductorului de nul!

Blocuri cu protecție diferențială, tip EVOV

230/400 V AC	x20.000	x10.000	IP 20	35x7.5	[mm ²] 2,5-25	T_a -25..+55°C	U _i 500 V	V0 UL94		AC	I_{cn} EN 60898 6 kA	
-----------------	---------	---------	-----------------	--------	------------------------------	------------------------------------	-------------------------	-------------------	--	-----------	---	--

TRACON	I _n (A)	I _{Δn} (mA)
EVOV2P2503	25	30
EVOV2P4003	40	30
EVOV2P6303	63	30
EVOV2P8003	80	30
EVOV2P251	25	100
EVOV2P401	40	100
EVOV2P631	63	100
EVOV2P801	80	100
EVOV2P253	25	300
EVOV2P403	40	300
EVOV2P633	63	300
EVOV2P803	80	300
EVOV4P2503	25	30
EVOV4P4003	40	30
EVOV4P6303	63	30
EVOV4P8003	80	30
EVOV4P251	25	100
EVOV4P401	40	100
EVOV4P631	63	100
EVOV4P801	80	100
EVOV4P253	25	300
EVOV4P403	40	300
EVOV4P633	63	300
EVOV4P803	80	300

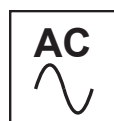
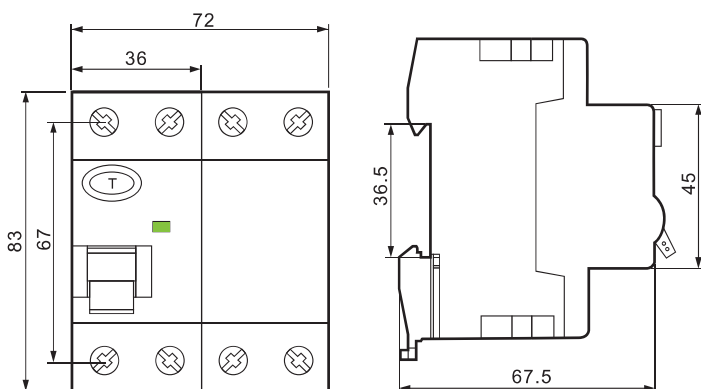
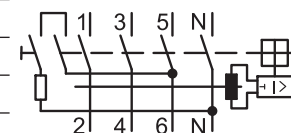
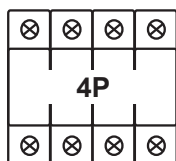
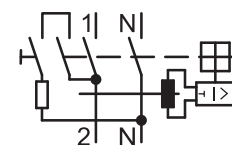
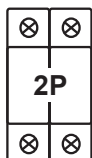

Pentru rețele de curent alternativ!

RELEVANT STANDARD
EN 61008-1



Blocuri cu protecție diferențială, tip EVOG

230/400 V AC
IP 20
35x7.5
2,5-35 [mm²]
Ta -25...+55°C
500 V U_i
V0 UL94
A, AC
I_{cn} EN 60898 6 kA
OFF

TRACON	I _n (A)	I _{Δn} (mA)
EVOG2P2503	25	30
EVOG2P4003	40	30
EVOG2P6303	63	30
EVOG2P8003	80	30
EVOG2P251	25	100
EVOG2P401	40	100
EVOG2P631	63	100
EVOG2P801	80	100
EVOG2P253	25	300
EVOG2P403	40	300
EVOG2P633	63	300
EVOG2P803	80	300
EVOG4P2503	25	30
EVOG4P4003	40	30
EVOG4P6303	63	30
EVOG4P8003	80	30
EVOG4P251	25	100
EVOG4P401	40	100
EVOG4P631	63	100
EVOG4P801	80	100
EVOG4P253	25	300
EVOG4P403	40	300
EVOG4P633	63	300
EVOG4P803	80	300

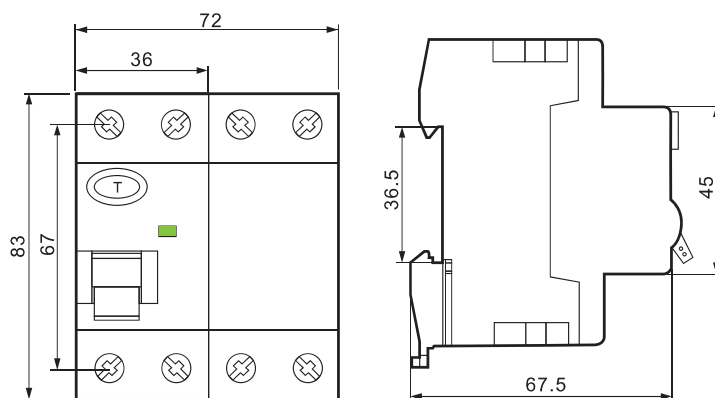
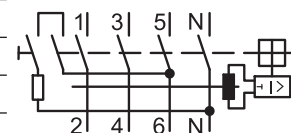
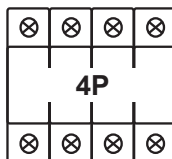
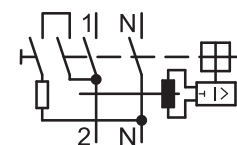
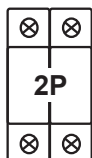

Pentru rețele de curent alternativ și de curent continuu pulsatoriu!



RELEVANT STANDARD
EN 61008-1



J/10 - J/25

Intrerupătoare separatoare modulare, tip EVOTIK

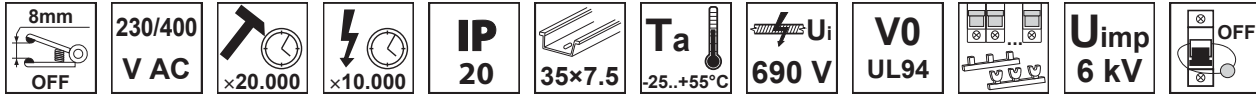

	TRACON	In (A)	mm ²
1P	TIK1-20	20	16-50
	TIK1-25	25	
	TIK1-32	32	
	TIK1-40	40	
	TIK1-63	63	
	TIK1-80	80	
	TIK1-100	100	
2P	TIK2-20	20	16-50
	TIK2-25	25	
	TIK2-32	32	
	TIK2-40	40	
	TIK2-63	63	
	TIK2-80	80	
	TIK2-100	100	
TIK2-125	125		

	TRACON	In (A)	mm ²
3P	TIK3-20	20	16-50
	TIK3-25	25	
	TIK3-32	32	
	TIK3-40	40	
	TIK3-63	63	
	TIK3-80	80	
	TIK3-100	100	
4P	TIK4-20	20	16-50
	TIK4-25	25	
	TIK4-32	32	
	TIK4-40	40	
	TIK4-63	63	
	TIK4-80	80	
	TIK4-100	100	
TIK4-125	125		

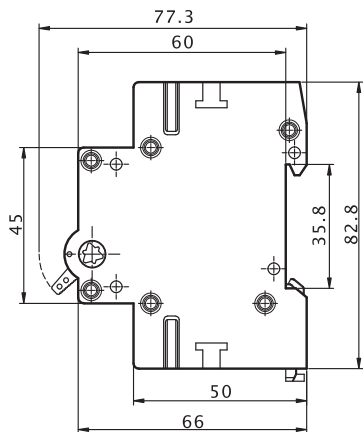
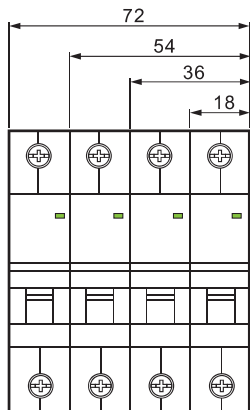
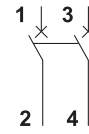
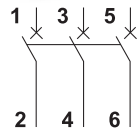
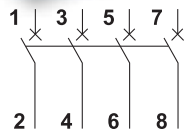

RELEVANT STANDARD
EN 60947-3



F/21

Selectoare modulare, tip EVOSVK

230/400 V AC	$\times 30.000$	$\times 10.000$	IP 20	35x7.5	[mm ²] 1-16	Ta -25..+55°C	U_i 690 V	V0 UL94		U_{imp} 6 kV	1 0 2
-----------------	-----------------	-----------------	-----------------	--------	----------------------------	-------------------------	----------------	-------------------	--	--------------------------------	-------

TRACON	I _n (A)
--------	-----------------------



SVK1-16	16
SVK1-32	32
SVK1-63	63



SVK2-16	16
SVK2-32	32
SVK2-63	63

TRACON	I _n (A)
--------	-----------------------



SVK3-16	16
SVK3-32	32
SVK3-63	63

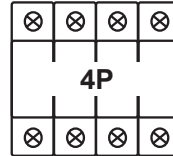

SVK4-16	16
SVK4-32	32
SVK4-63	63

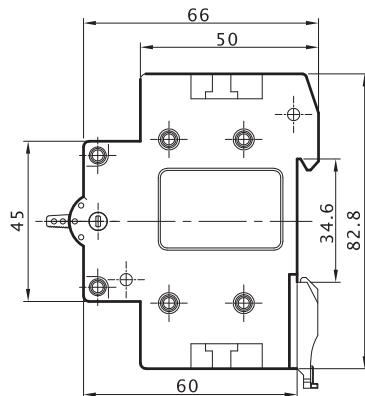
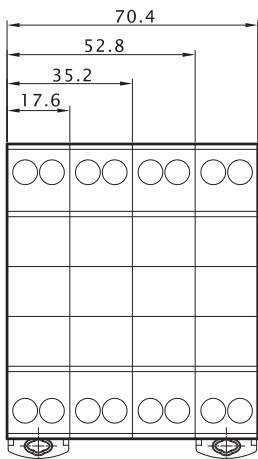
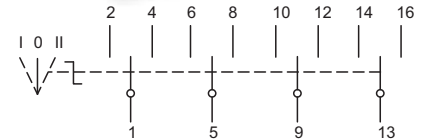
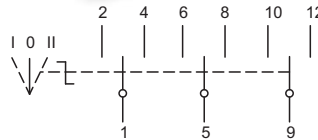
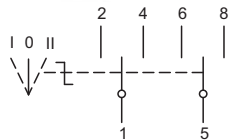
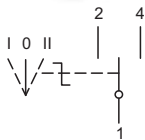

RELEVANT STANDARD
EN 60947-3

RELEVANT STANDARD
EN 60669-1

TÜV MEEI TEST DOCUMENTATION
28211822 001

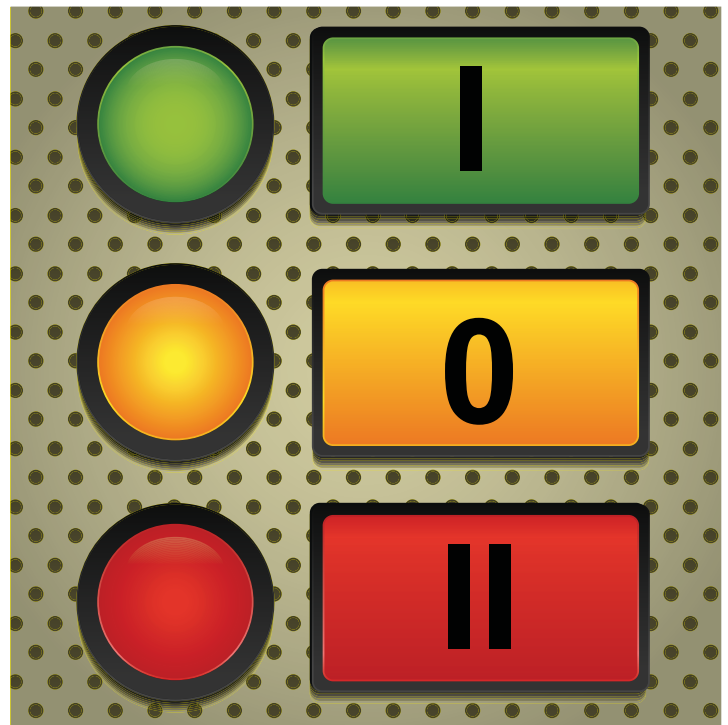

Întreprupător separator modular cu zăvorâre prin lacăt, tip EVOMS

230 V AC **IP 20** **35×7.5** **T_a -25..+55°C** **U_i 800 V** **OFF**

Legendă pictograme **F/0**

TRACON	I _{th} (40 °C)	A (mm)	B (mm)	C (mm)	D (mm)	E (mm)	mm ²
EVOMS16/3	16A/3P						
EVOMS20/3	20A/3P	73,3	81	65,5	75,5	36,5	1,5-16
EVOMS25/3	25A/3P						
EVOMS40/3	40A/3P						
EVOMS80/3	80A/3P						
EVOMS100/3	100A/3P	88	97,5	76,5	93,5	52	25-50
EVOMS125/3	125A/3P						

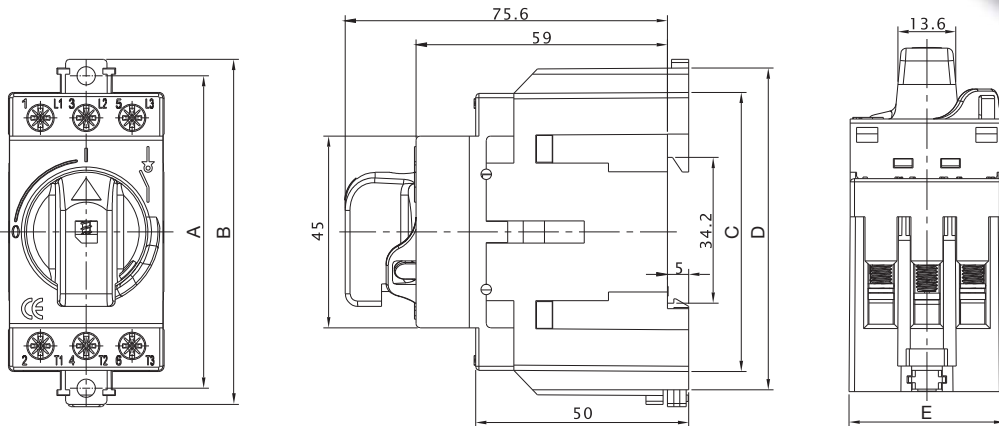

RELEVANT STANDARD
EN 60947-3

Lămpi de semnalizare modulare, tip EVOSLJL

P_m 0,8 VA **20.000 [h]** **IP 20** **[mm²] 1-25** **35×7.5** **T_a -25..+55°C**

Legendă pictograme **F/0**

TRACON		U _n		L E D
SLJL-AC230-P	Red	230 V AC	× 1 LED	
SLJL-AC230-Z	Green	230 V AC	× 1 LED	
SLJL-AC230-S	Yellow	230 V AC	× 1 LED	
SLJL-AC230-F	White	230 V AC	× 1 LED	
SLJL-AC230-K	Blue	230 V AC	× 1 LED	
SLJL-AC24-P	Red	24 V AC	× 1 LED	
SLJL-AC24-Z	Green	24 V AC	× 1 LED	
SLJL-AC24-S	Yellow	24 V AC	× 1 LED	
SLJL-AC24-F	White	24 V AC	× 1 LED	
SLJL-AC24-K	Blue	24 V AC	× 1 LED	
SLJL-AC230-SZP	Red, Green, Yellow	3×230 V AC	× 3 LED	
SLJL-DC220-P	Red	220 V DC	× 1 LED	
SLJL-DC220-Z	Green	220 V DC	× 1 LED	
SLJL-DC220-S	Yellow	220 V DC	× 1 LED	
SLJL-DC220-F	White	220 V DC	× 1 LED	
SLJL-DC220-K	Blue	220 V DC	× 1 LED	
SLJL-DC24-P	Red	24 V DC	× 1 LED	
SLJL-DC24-Z	Green	24 V DC	× 1 LED	
SLJL-DC24-S	Yellow	24 V DC	× 1 LED	
SLJL-DC24-F	White	24 V DC	× 1 LED	
SLJL-DC24-K	Blue	24 V DC	× 1 LED	

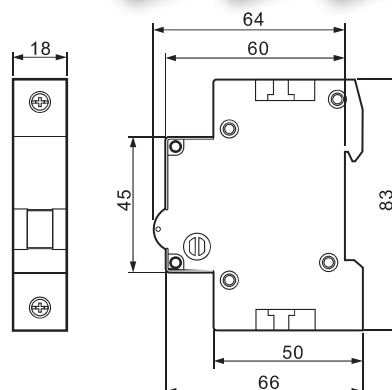

RELEVANT STANDARD
EN 62094-1
EN 60947-5

Buton modular, comutator modular, tip EVOP

230 V AC
 $\times 250.000$
 $\times 10.000$
IP 20
35x7.5
[mm²] 1-10
Ta -5..+55 °C
500 V U_i
V0 UL94

Legendă pictograme
F/O



EVOPS

EVOPB2

EVOPSL

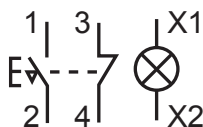
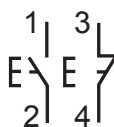
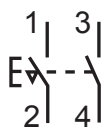

TRACON	I _{th}	I _e (AC-14) (230V AC)	NC NO
EVOPS	16A	6A	2NO
EVOPB2	16A	6A	1NO+1NC
EVOPSL	16A	6A	1NO+1NC

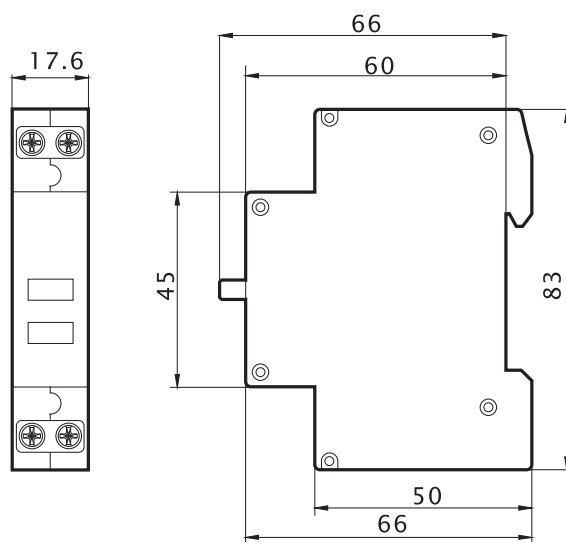

RELEVANT STANDARD
EN 60947-5-1

Transformatoare de siguranță (pt. sonerii), tip EVOBT

IP 20
35x7.5
[mm²] 1,5-30
Ta -25..+55 °C
500 V U_i
V0 UL94

Legendă pictograme
F/O



EVOBT15/1



EVOBT30/1

TRACON	P _s	U _{pr}	U _{sec}	I _{sec}
EVOBT15/1	max. 14 VA		4-8-12V AC	1,15 A
EVOBT24/1	max. 37 VA	230V AC	12-24V AC	1,55 A
EVOBT30/1	max. 37 VA		12-12-24V AC	1,55 A

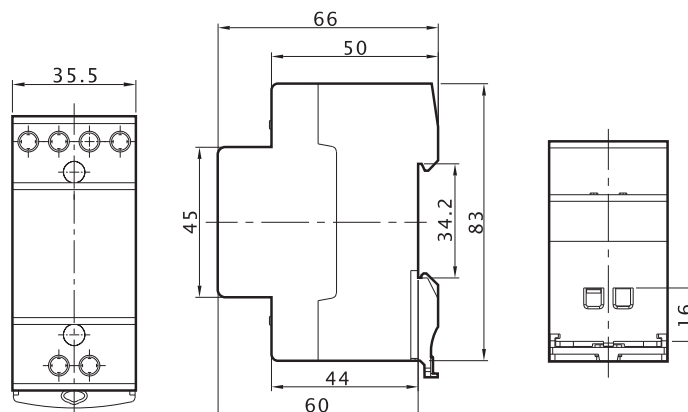

RELEVANT STANDARD
EN 60947-5-1

RELEVANT STANDARD
EN 61558-2-8

Contactoare de instalații, tip EVOHK

230/400 V AC	$\times 2.000.000$	$\times 125.000$	IP 20	35x7.5	[mm ²] 1,5-35	Ta -5...+55 °C	U_i 500 V	V0 UL94	ON-OFF-ON... sc/h $\times 360$	U_{imp} 4 kV
-----------------	--------------------	------------------	--------------	--------	------------------------------	--------------------------	-------------------------------	-------------------	--------------------------------------	--------------------------------

TRACON	U _m	I _n (A)	W (mm)	P _e (kW)				P _s			NC NO
				AC1 / AC7a 230V	AC3 / AC7b 230V	AC1 / AC7a 400V	AC3 / AC7b 400V				
EVOHK2-25	230 V AC	25	17,5	5	1,5	-	-	1,35 W	20A gG		2 × NO
EVOHK2-25-24	24 V AC	25	17,5	5	1,5	-	-	1,35 W	20A gG		2 × NO
EVOHK2-25V	230 V AC	25	17,5	5	1,5	-	-	1,35 W	20A gG		1 × NO+1 × NC
EVOHK2-40	230 V AC	40	35,4	9	2,2	-	-	1,55 W	32A gG		2 × NO
EVOHK2-63	230 V AC	63	35,4	11,6	3,3	-	-	1,55 W	50A gG		2 × NO
EVOHK2-80	230 V AC	80	54	16	5,5	-	-	1,55 W	63A gG		2 × NO
EVOHK2-100	230 V AC	100	54	19	6	-	-	1,55 W	80A gG		2 × NO
EVOHK4-25	230 V AC	25	35	5	1,5	16	4	1,35 W	20A gG		4 × NO
EVOHK4-25-24	24 V AC	25	35	5	1,5	16	4	1,35 W	20A gG		4 × NO
EVOHK4-40	230 V AC	40	53,3	9	2,2	27,5	12,5	1,55 W	32A gG		4 × NO
EVOHK4-63	230 V AC	63	53,3	11,6	3,3	40	15	1,55 W	50A gG		4 × NO
EVOHK4-80	230 V AC	80	108	16	5,5	50	18,5	1,55 W	63A gG		4 × NO
EVOHK4-100	230 V AC	100	108	19	6	60	22	1,55 W	80A gG		4 × NO

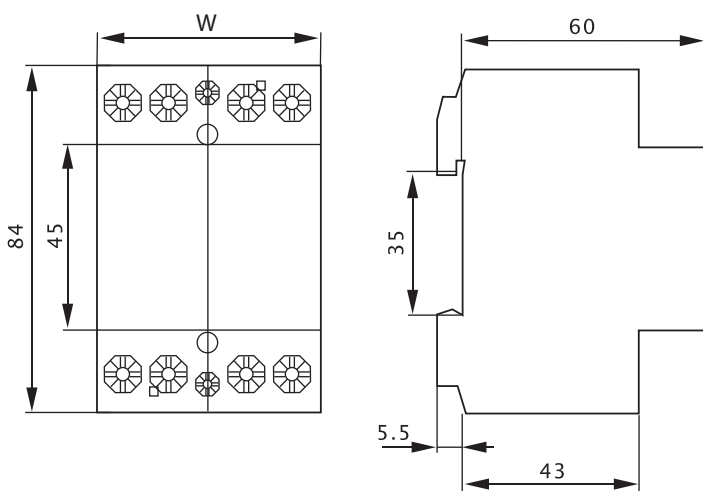

RELEVANT STANDARD
EN 60947-4-1

RELEVANT STANDARD
EN 61095

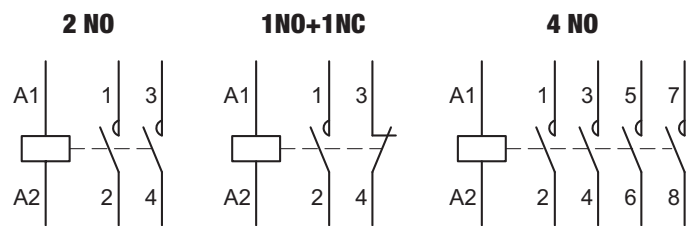

CITIȚI CODUL !

- Vezi noutățile noastre
- Fiți informat

Gama de produse se dezvoltă continuu și rapid!
Catalogul nostru reflectă situația din Octombrie 2017.
Pentru informații actualizate vizitați pagina
noastră de internet!

Relee de recuplare automată la creșterea/scăderea tensiunii

32 A gG	230/400 V AC	x4.000	IP 20	35x7.5	1,5-25 mm ²	Ta -20..+55°C	500 V Ui	
---------	--------------	--------	-------	--------	------------------------	---------------	----------	--

Legendă pictograme **F/O**

TRACON	2P	4P
	EVOU02	EVOU04
Tensiune nominală	230 V AC	230 V AC (L-N)
Frecvență nominală	50 Hz	
Curent nominal	40 A (AC 1)	
Putere absorbită	AC max. 3 VA	
Nivel superior de protecție la tensiune	265 V (fix)	265 V (L-N) (fix)
Nivel superior de recuplare	257 V (fix)	257 V (L-N) (fix)
Nivel inferior de protecție la tensiune	175 V (fix)	175 V (L-N) (fix)
Nivel inferior de recuplare	180 V (fix)	180 V (L-N) (fix)
Timpe de cuplare	1 s	
Temporizare la cuplare	2 s	
Timpe de recuplare	30 s	
Eroarea de măsură	≤1%	
Masa	120 g	250 g



EVOU02



EVOU04

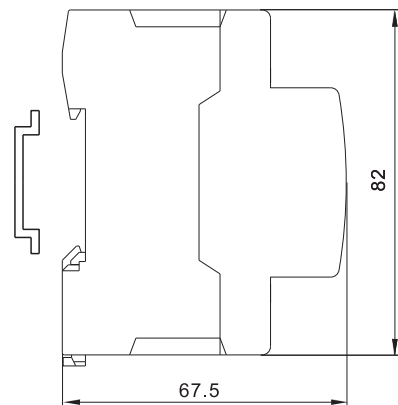
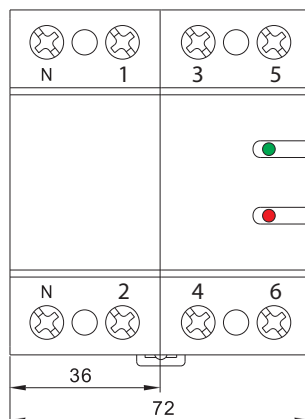

- Protecție împotriva creșterii și scăderii tensiunii.
- Aparatul deconectează circuitul de la rețeaua electrică, în cazul în care tensiunea depășește valoarea de prag
- Imediat ce tensiunea este restabilă, după o temporizare de 30 s recuplează automat circuitul!
- Starea de funcționare este indicată de LED-uri

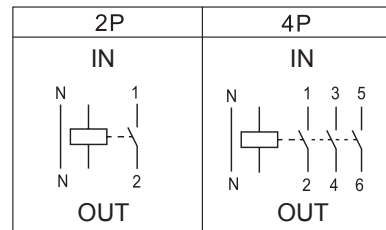
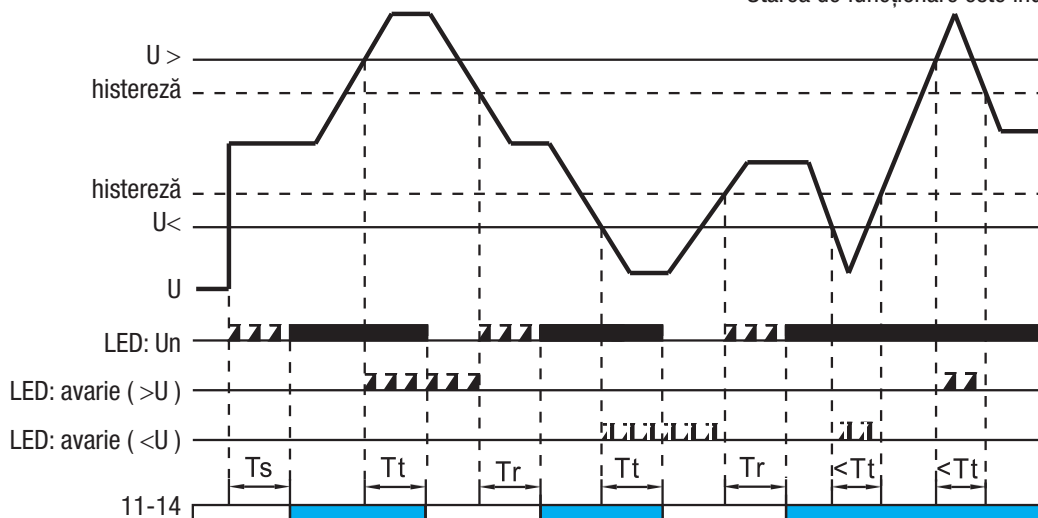

Ts: Timpe de pornire
Tt: Temporizare la decuplare
Tr: Timpe de reset

Contact auxiliar

230/400 V AC	×6.000	×5.000	IP 20	35×7.5	[mm ²] 1,5-25	T_a -25..+55°C	U_i 500 V	V0 UL94
-----------------	--------	--------	-----------------	--------	------------------------------	------------------------------------	-------------------------------	-------------------

Legendă pictograme **F/0**

TRACON			I_n (A) (415 V AC)	I_n (A) (240 V AC)	I_n (A) (125 V DC)	I_n (A) (48 V DC)	I_n (A) (24 V DC)
TDZ-F2		TDZ	3 A	6 A	1 A	2 A	4 A

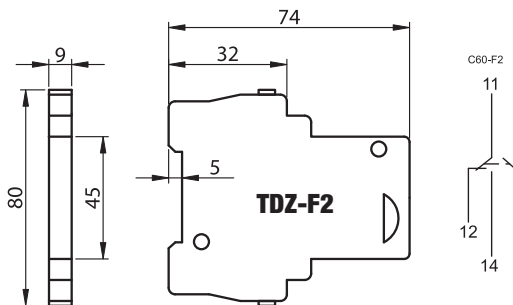

Indică starea de închis sau deschis al contactelor si-guranței.



Declanșor de tensiune de lucru (șunt)

230/400 V AC	×6.000	×4.000	IP 20	35×7.5	[mm ²] 1,5-25	T_a -25..+55°C	U_i 500 V	V0 UL94
-----------------	--------	--------	-----------------	--------	------------------------------	------------------------------------	-------------------------------	-------------------

Legendă pictograme **F/0**

TRACON			U_s
C60-S2		TDZ	110-415 V AC/ 110-220 V DC

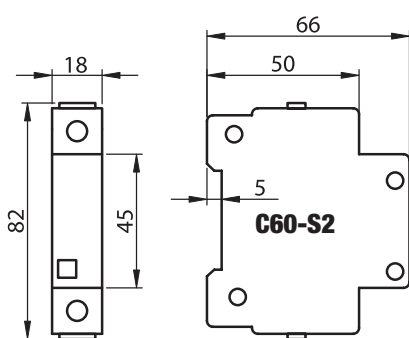

La un impuls de tensiune de acționare decuplează siguranța automată. Astfel se poate utiliza pentru aplicații de acționare de la distanță. După decuplare, siguranța poate fi comutată din nou doar după apăsarea butonului Reset de pe declanșor. Atenție!: Bobina de acționare poate fi alimentat maxim 10sec!

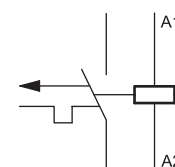

Declanșor la variații de tensiune

230/400 V AC	×6.000	×4.000	IP 20	35×7.5	[mm ²] 1,5-25	T_a -25..+55°C	U_i 500 V	V0 UL94
-----------------	--------	--------	-----------------	--------	------------------------------	------------------------------------	-------------------------------	-------------------

Legendă pictograme **F/0**

TRACON			U_{up}	U_{down}
C60-U2/02		TDZ	280 V ± 5 %	170 V ± 5 %

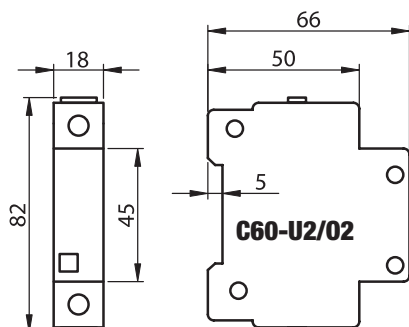

Decuplează siguranța automată în cazul în care tensiunea rețelei diferă de domeniul specificat a tensiunii de funcționare, protejând astfel consumatorul de efectele dăunătoare (distru-gătoare) ale variațiilor de tensiune. Siguranța automată poate fi cuplată din nou doar dacă tensiunea revine în plaja domeniului de funcționare (170-280V). În cazul declanșării butonul de reset iese afară și doar după apăsarea lui se va putea recupla înapoi siguranța automată.

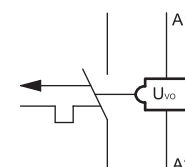

Zăvoare pentru siguranțe automate

Cu ajutorul zăvorului care se poate închide cu lacătul, dispozitivele de protecție în funcție de tipul lor, se pot zăvorî în poziția decuplată cu ajutorul unui lacăt. Zăvoarele se pot utiliza în gama de lățimi de 8-10 mm a decupajului pentru brațul de cuplare. Pe ambele margini ale decupajului în punctul cel mai înalt al arcului sunt necesare găuri de 1-1,5 mm pentru montarea urechilor zăvorului. Diametrul maxim al inelului lacătului care se utilizează: 8 mm. Este interzisă utilizarea zăvorului în poziția „Cuplat” !

TRACON



MDL

MB, RB, TDZ, TDA, KVKM, KVK, KVKVE, TFG, TFIG, TFV, TIK, SVK



Siguranțe automate DPN (Fază-nul)

230/400
V AC

x20.000

x6.000

IP
20

35x7.5

[mm²]
1,5-25

Ta
-25..+55°C

U_i
500 V

V0
UL94



I_{2t}
3

I_{cn}
EN 60898
4,5 kA

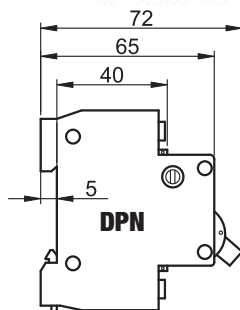
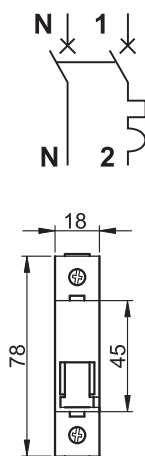

TRACON



I_n
(A)

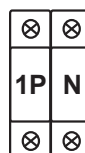

DPN-C-6	6
DPN-C-10	10
DPN-C-13	13
DPN-C-16	16
DPN-C-20	20
DPN-C-25	25
DPN-C-32	32

* Siguranță cu doi poli care protejează faza și comută nului.

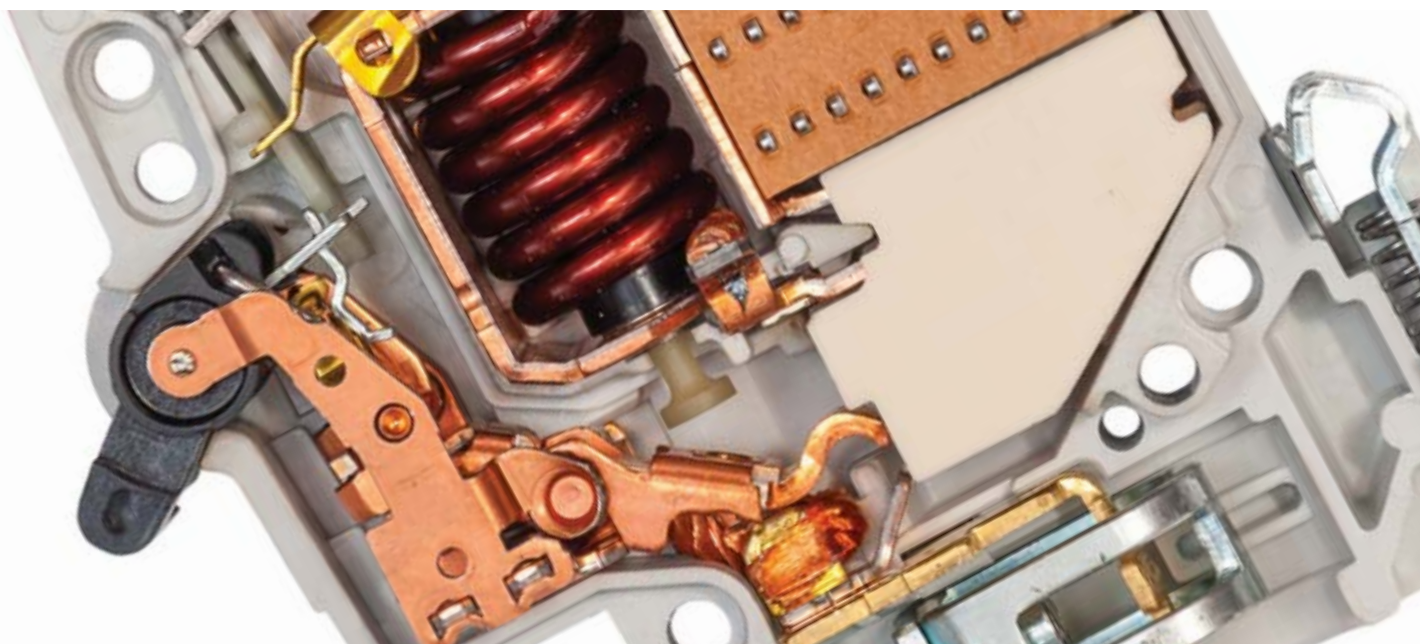

Siguranțe automate tip MB

230/400 V AC	x20.000	x6.000	IP 20	35x7.5	[mm ²] 1,5-25	Ta -25..+55°C	U_i 500 V	V0 UL94		I_{2t} 3	I_{cn} EN 60898 4,5 kA	
-----------------	---------	--------	-----------------	--------	------------------------------	-------------------------	-------------------------------	-------------------	--	----------------------------	---	--

TRACON			I _n (A)
MB-1B-6	MB-1C-6		6
MB-1B-10	MB-1C-10		10
MB-1B-13	MB-1C-13		13
MB-1B-16	MB-1C-16		16
MB-1B-20	MB-1C-20		20
MB-1B-25	MB-1C-25		25
MB-1B-32	MB-1C-32		32
MB-1B-40	MB-1C-40		40
MB-1B-50	MB-1C-50		50
MB-1B-63	MB-1C-63		63
MB-2B-6	MB-2C-6		6
MB-2B-10	MB-2C-10		10
MB-2B-13	MB-2C-13		13
MB-2B-16	MB-2C-16		16
MB-2B-20	MB-2C-20		20
MB-2B-25	MB-2C-25		25
MB-2B-32	MB-2C-32		32
MB-2B-40	MB-2C-40		40
MB-2B-50	MB-2C-50		50
MB-2B-63	MB-2C-63		63

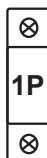

TRACON			I _n (A)
MB-3B-6	MB-3C-6		6
MB-3B-10	MB-3C-10		10
MB-3B-13	MB-3C-13		13
MB-3B-16	MB-3C-16		16
MB-3B-20	MB-3C-20		20
MB-3B-25	MB-3C-25		25
MB-3B-32	MB-3C-32		32
MB-3B-40	MB-3C-40		40
MB-3B-50	MB-3C-50		50
MB-3B-63	MB-3C-63		63
-	MB-4C-10		10
-	MB-4C-16		16
-	MB-4C-20		20
-	MB-4C-25		25
-	MB-4C-32		32
-	MB-4C-40		40
-	MB-4C-50		50
-	MB-4C-63		63

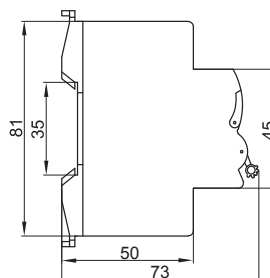
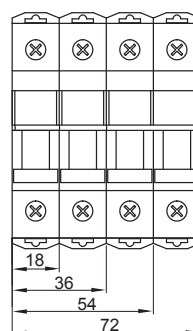
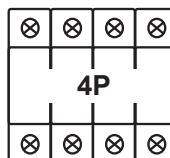
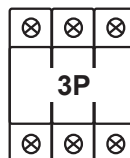

RELEVANT STANDARD
EN 60898

TÜV MEEI TEST DOCUMENTATION
03401-2014183F

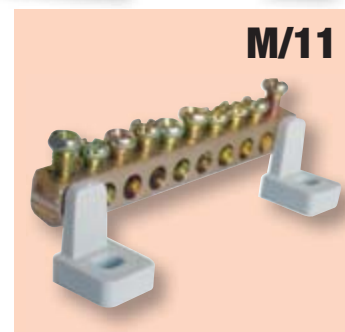
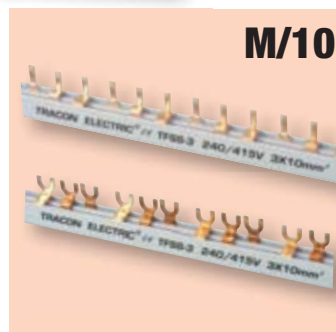
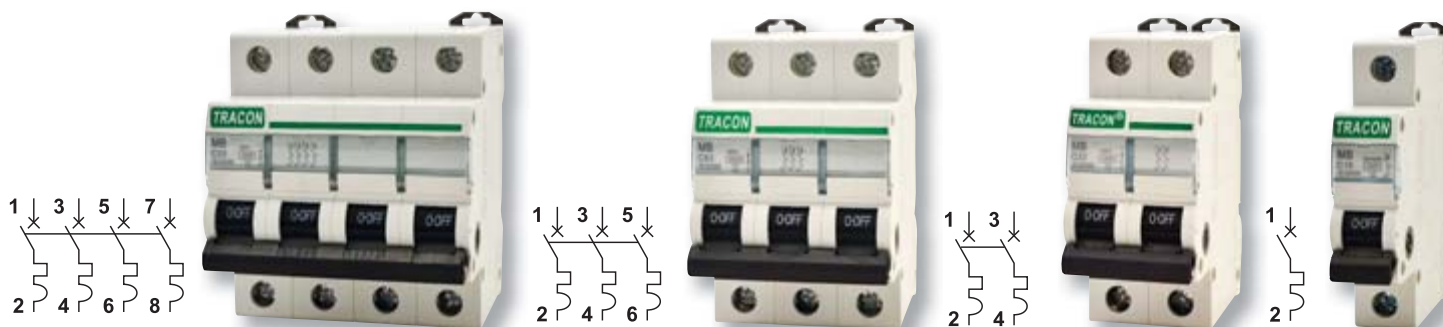

Siguranțe automate tip TDZ

TRACON				I _n (A)
B	C	D		
TDZ-1B-1	TDZ-1C-1	TDZ-1D-1		1
TDZ-1B-2	TDZ-1C-2	TDZ-1D-2		2
TDZ-1B-4	TDZ-1C-4	TDZ-1D-4		4
TDZ-1B-6	TDZ-1C-6	TDZ-1D-6		6
TDZ-1B-10	TDZ-1C-10	TDZ-1D-10		10
TDZ-1B-13	TDZ-1C-13	TDZ-1D-13		13
TDZ-1B-16	TDZ-1C-16	TDZ-1D-16		16
TDZ-1B-20	TDZ-1C-20	TDZ-1D-20		20
TDZ-1B-25	TDZ-1C-25	TDZ-1D-25		25
TDZ-1B-32	TDZ-1C-32	TDZ-1D-32		32
TDZ-1B-40	TDZ-1C-40	TDZ-1D-40		40
TDZ-1B-50	TDZ-1C-50	TDZ-1D-50		50
TDZ-1B-63	TDZ-1C-63	TDZ-1D-63		63
TDZ-2B-1	TDZ-2C-1	TDZ-2D-1		1
TDZ-2B-2	TDZ-2C-2	TDZ-2D-2		2
TDZ-2B-4	TDZ-2C-4	TDZ-2D-4		4
TDZ-2B-6	TDZ-2C-6	TDZ-2D-6		6
TDZ-2B-10	TDZ-2C-10	TDZ-2D-10		10
TDZ-2B-13	TDZ-2C-13	TDZ-2D-13		13
TDZ-2B-16	TDZ-2C-16	TDZ-2D-16		16
TDZ-2B-20	TDZ-2C-20	TDZ-2D-20		20
TDZ-2B-25	TDZ-2C-25	TDZ-2D-25		25
TDZ-2B-32	TDZ-2C-32	TDZ-2D-32		32
TDZ-2B-40	TDZ-2C-40	TDZ-2D-40		40
TDZ-2B-50	TDZ-2C-50	TDZ-2D-50		50
TDZ-2B-63	TDZ-2C-63	TDZ-2D-63		63

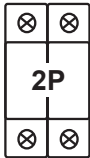

TRACON				I _n (A)
B	C	D		
TDZ-3B-1	TDZ-3C-1	TDZ-3D-1		1
TDZ-3B-2	TDZ-3C-2	TDZ-3D-2		2
TDZ-3B-4	TDZ-3C-4	TDZ-3D-4		4
TDZ-3B-6	TDZ-3C-6	TDZ-3D-6		6
TDZ-3B-10	TDZ-3C-10	TDZ-3D-10		10
TDZ-3B-13	TDZ-3C-13	TDZ-3D-13		13
TDZ-3B-16	TDZ-3C-16	TDZ-3D-16		16
TDZ-3B-20	TDZ-3C-20	TDZ-3D-20		20
TDZ-3B-25	TDZ-3C-25	TDZ-3D-25		25
TDZ-3B-32	TDZ-3C-32	TDZ-3D-32		32
TDZ-3B-40	TDZ-3C-40	TDZ-3D-40		40
TDZ-3B-50	TDZ-3C-50	TDZ-3D-50		50
TDZ-3B-63	TDZ-3C-63	TDZ-3D-63		63
TDZ-4B-1	TDZ-4C-1	TDZ-4D-1		1
TDZ-4B-2	TDZ-4C-2	TDZ-4D-2		2
TDZ-4B-4	TDZ-4C-4	TDZ-4D-4		4
TDZ-4B-6	TDZ-4C-6	TDZ-4D-6		6
TDZ-4B-10	TDZ-4C-10	TDZ-4D-10		10
TDZ-4B-13	TDZ-4C-13	TDZ-4D-13		13
TDZ-4B-16	TDZ-4C-16	TDZ-4D-16		16
TDZ-4B-20	TDZ-4C-20	TDZ-4D-20		20
TDZ-4B-25	TDZ-4C-25	TDZ-4D-25		25
TDZ-4B-32	TDZ-4C-32	TDZ-4D-32		32
TDZ-4B-40	TDZ-4C-40	TDZ-4D-40		40
TDZ-4B-50	TDZ-4C-50	TDZ-4D-50		50
TDZ-4B-63	TDZ-4C-63	TDZ-4D-63		63

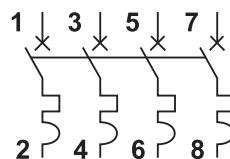
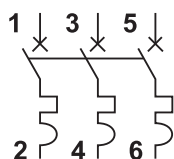
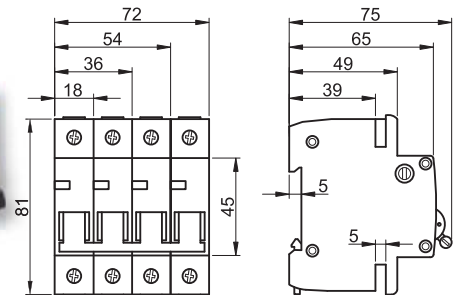
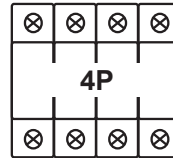
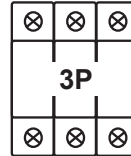

Legendă pictograme

F/0

RELEVANT STANDARD
EN 60898



Siguranțe automate tip DC, pentru rețele electrice de curent continuu



TRACON	U _i	U _e (6kV)	U _e (10kV)	I _{cu} EN 60898-2	I _{cu} EN 60947-2
DC-1C-..	500 V DC	125 V, 250 V	110 V, 220 V	6 kA	10 kA
DC-2C-..	500 V DC	250 V, 500 V	220 V, 440 V	6 kA	10 kA
DC-3C-..	1000 V DC	375 V, 750 V	330 V, 660 V	6 kA	10 kA
DC-4C-..	1000 V DC	500 V, 1000 V	440 V, 880 V	6 kA	10 kA

TRACON	I _n (A)
DC-1C-6	6
DC-1C-10	10
DC-1C-13	13
DC-1C-16	16
DC-1C-20	20
DC-1C-25	25
DC-1C-32	32
DC-1C-40	40
DC-1C-50	50
DC-1C-63	63
DC-2C-6	6
DC-2C-10	10
DC-2C-13	13
DC-2C-16	16
DC-2C-20	20
DC-2C-25	25
DC-2C-32	32
DC-2C-40	40
DC-2C-50	50
DC-2C-63	63

TRACON	I _n (A)
DC-3C-6	6
DC-3C-10	10
DC-3C-13	13
DC-3C-16	16
DC-3C-20	20
DC-3C-25	25
DC-3C-32	32
DC-3C-40	40
DC-3C-50	50
DC-3C-63	63
DC-4C-6	6
DC-4C-10	10
DC-4C-13	13
DC-4C-16	16
DC-4C-20	20
DC-4C-25	25
DC-4C-32	32
DC-4C-40	40
DC-4C-50	50
DC-4C-63	63

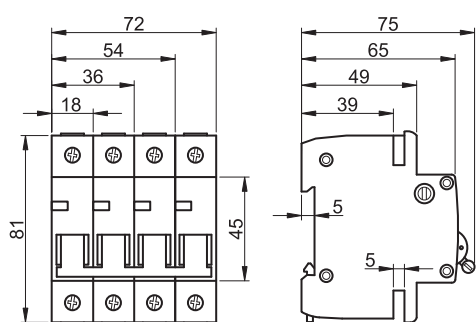

TÜV MEEI TEST DOCUMENTATION
28216230 001

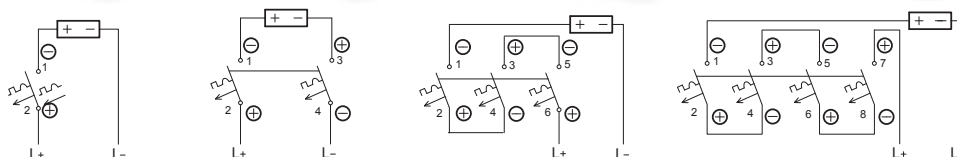

CITIȚI CODUL !

- Vezi noutățile noastre
- Fiți informat

Gama de produse se dezvoltă continuu și rapid!
Catalogul nostru reflectă situația din Octombrie 2017.
Pentru informații actualizate vizitați pagina noastră de internet!

Siguranțe pentru curenți mari KMH

230/400 V AC	$\times 10.000$	$\times 4.000$	IP 20	35x7.5	[mm ²] 16-35	Ta -25..+55°C	U_i 500 V	V0 UL94		12t 3	I_{cn} EN 60898 6 kA	
-----------------	-----------------	----------------	-----------------	--------	-----------------------------	-------------------------	-------------------------------	-------------------	--	-----------------	---	--

TRACON		I_n (A)
	C	

TRACON		I_n (A)
	C	

	KMH-163	63
	KMH-180	80
	KMH-1100	100
	KMH-1125	125

	KMH-363	63
	KMH-380	80
	KMH-3100	100
	KMH-3125	125

	KMH-263	63
	KMH-280	80
	KMH-2100	100
	KMH-2125	125

	KMH-463	63
	KMH-480	80
	KMH-4100	100
	KMH-4125	125

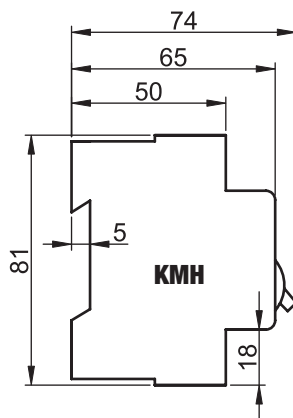
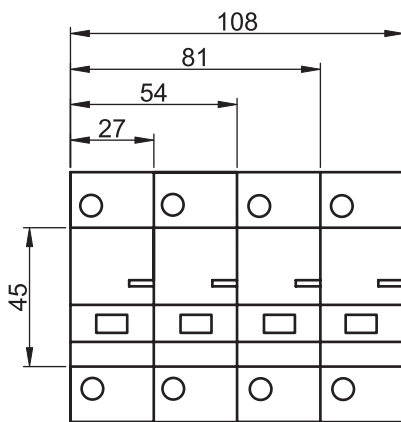
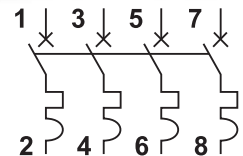
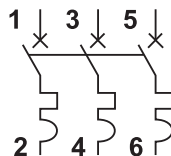
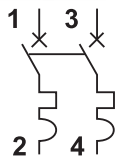

Curbă caracteristică de decuplare

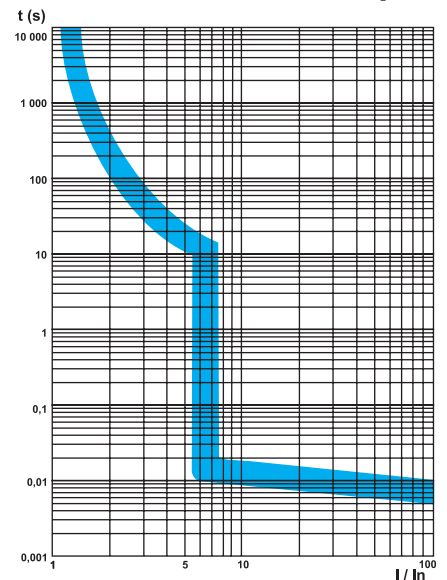

Legendă pictograme **F/0**

RELEVANT STANDARD
EN 60898

KVKVE Întrerupător cu protecție combinată, 1 modul lățime

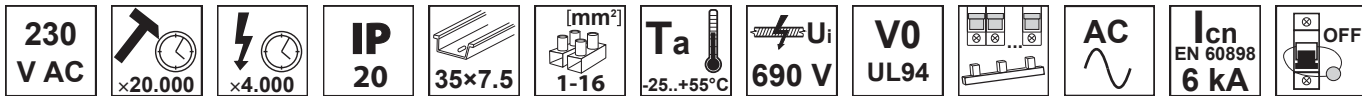

TRACON		I _n (A)	I Δ _n (mA)
B	C		
KVKVEB-6/30	KVKVE-6/30	6	30
KVKVEB-6/100	KVKVE-6/100	6	100
KVKVEB-10/30	KVKVE-10/30	10	30
KVKVEB-10/100	KVKVE-10/100	10	100
KVKVEB-13/30	KVKVE-13/30	13	30
KVKVEB-13/100	KVKVE-13/100	13	100
KVKVEB-16/30	KVKVE-16/30	16	30
KVKVEB-16/100	KVKVE-16/100	16	100
KVKVEB-20/30	KVKVE-20/30	20	30
KVKVEB-20/100	KVKVE-20/100	20	100
KVKVEB-25/30	KVKVE-25/30	25	30
KVKVEB-25/100	KVKVE-25/100	25	100
KVKVEB-32/30	KVKVE-32/30	32	30
KVKVEB-32/100	KVKVE-32/100	32	100



Caracteristici de decuplare

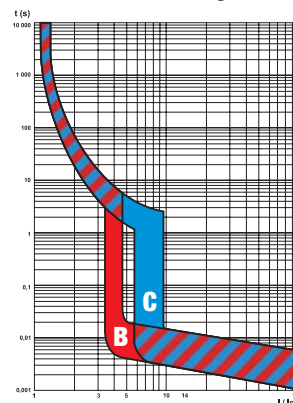

E3

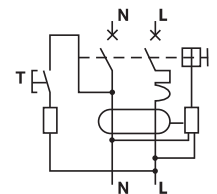
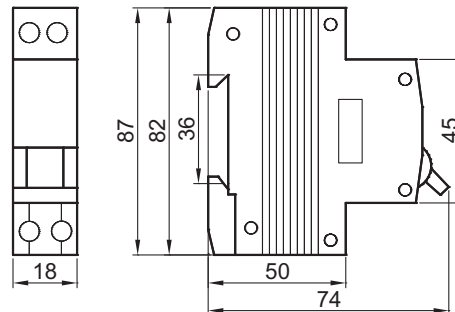

Legendă pictograme F/O

RELEVANT STANDARD EN 61009-1

Disjunctoare cu protecție diferențială KVK

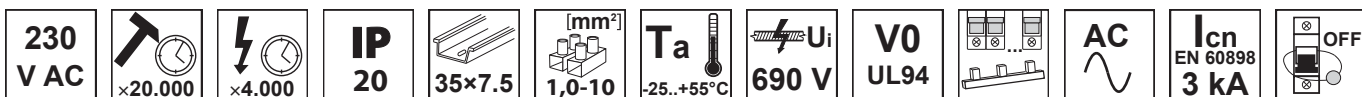

TRACON		I _n (A)	I Δ _n (mA)
B	C		
KVKB-6/03	KVK-6/03	6	30
KVKB-6/10	KVK-6/10	6	100
KVKB-6/30	KVK-6/30	6	300
KVKB-10/03	KVK-10/03	10	30
KVKB-10/10	KVK-10/10	10	100
KVKB-10/30	KVK-10/30	10	300
KVKB-16/03	KVK-16/03	16	30
KVKB-16/10	KVK-16/10	16	100
KVKB-16/30	KVK-16/30	16	300
KVKB-20/03	KVK-20/03	20	30
KVKB-20/10	KVK-20/10	20	100
KVKB-20/30	KVK-20/30	20	300
KVKB-25/03	KVK-25/03	25	30
KVKB-25/10	KVK-25/10	25	100
KVKB-25/30	KVK-25/30	25	300
KVKB-32/03	KVK-32/03	32	30
KVKB-32/10	KVK-32/10	32	100
KVKB-32/30	KVK-32/30	32	300

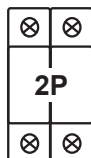

Caracteristici de decuplare

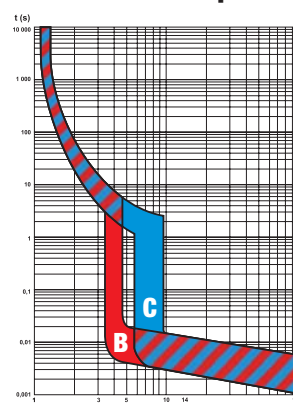

E3

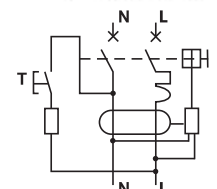
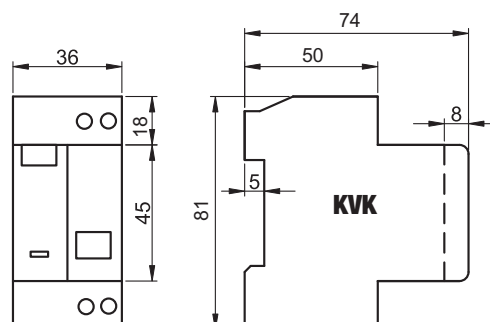

Disjunctoare cu protecție diferențială KVKM, electromecanice

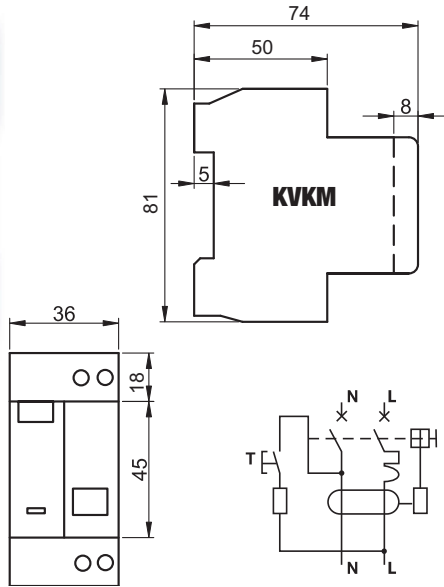
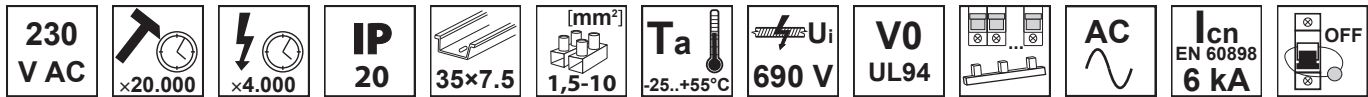

TRACON		I _n (A)	I Δ _n (mA)
B	C		
KVKMB-6/030	KVKM-6/030	6	30
KVKMB-6/100	KVKM-6/100	6	100
KVKMB-6/300	KVKM-6/300	6	300
KVKMB-10/030	KVKM-10/030	10	30
KVKMB-10/100	KVKM-10/100	10	100
KVKMB-10/300	KVKM-10/300	10	300
KVKMB-16/030	KVKM-16/030	16	30
KVKMB-16/100	KVKM-16/100	16	100
KVKMB-16/300	KVKM-16/300	16	300
KVKMB-20/030	KVKM-20/030	20	30
KVKMB-20/100	KVKM-20/100	20	100
KVKMB-20/300	KVKM-20/300	20	300
KVKMB-25/030	KVKM-25/030	25	30
KVKMB-25/100	KVKM-25/100	25	100
KVKMB-25/300	KVKM-25/300	25	300
KVKMB-32/030	KVKM-32/030	32	30
KVKMB-32/100	KVKM-32/100	32	100
KVKMB-32/300	KVKM-32/300	32	300
KVKMB-40/030	KVKM-40/030	40	30
KVKMB-40/100	KVKM-40/100	40	100
KVKMB-40/300	KVKM-40/300	40	300

Înterupătoarele electromecanice cu protecție combinată oferă protecție împotriva electrocutării și în cazul întreruperii conductorului de nul!

Blocuri cu protecție diferențială RB

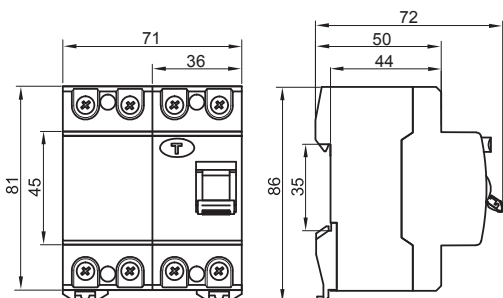
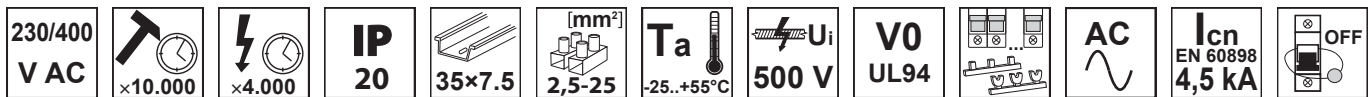

TRACON	I _n (A)	I Δ _n (mA)
RB2-25030	25	30
RB2-25100	25	100
RB2-25300	25	300
RB2-25500	25	500
RB2-40030	40	30
RB2-40100	40	100
RB2-40300	40	300
RB2-40500	40	500
RB4-25030	25	30
RB4-25100	25	100
RB4-25300	25	300
RB4-25500	25	500
RB4-40030	40	30
RB4-40100	40	100
RB4-40300	40	300
RB4-40500	40	500
RB4-63030	63	30
RB4-63100	63	100
RB4-63300	63	300
RB4-63500	63	500

Blocuri cu protecție diferențială de tip TFV

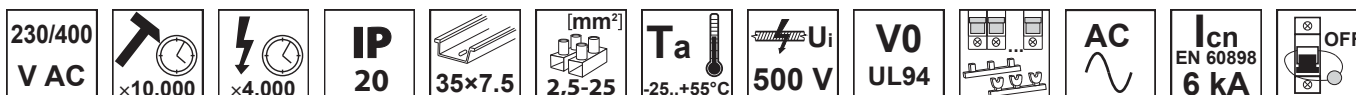

TRACON	I_n (A)	$I_{\Delta n}$ (mA)
TFV2-16030	16	30
TFV2-16100	16	100
TFV2-16300	16	300
TFV2-25030	25	30
TFV2-25100	25	100
TFV2-25300	25	300
TFV2-40030	40	30
TFV2-40100	40	100
TFV2-40300	40	300
TFV2-63030	63	30
TFV2-63100	63	100
TFV2-63300	63	300
TFV4-16030	16	30
TFV4-16100	16	100
TFV4-16300	16	300
TFV4-25030	25	30
TFV4-25100	25	100
TFV4-25300	25	300
TFV4-40030	40	30
TFV4-40100	40	100
TFV4-40300	40	300
TFV4-63030	63	30
TFV4-63100	63	100
TFV4-63300	63	300

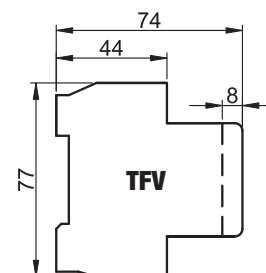
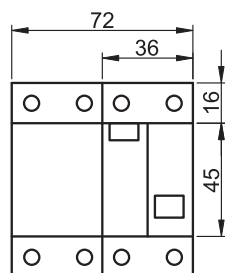
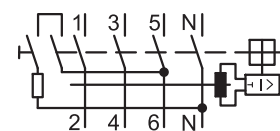
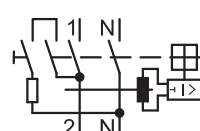
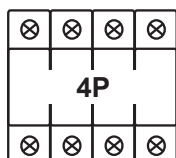
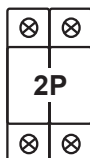

Blocuri cu protecție diferențială tip TFVH, pentru curenți mari

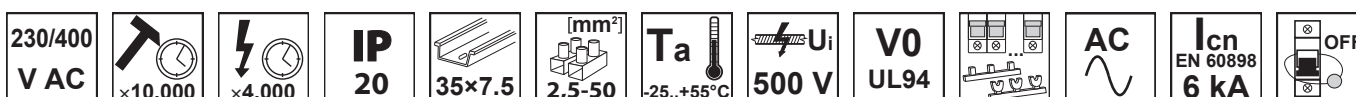

TRACON	I_n (A)	$I_{\Delta n}$ (mA)
TFVH4-80030	80	30
TFVH4-80100	80	100
TFVH4-80300	80	300
TFVH4-100030	100	30
TFVH4-100100	100	100
TFVH4-100300	100	300
TFVH4-125030	125	30
TFVH4-125100	125	100
TFVH4-125300	125	300

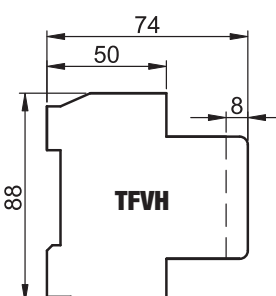
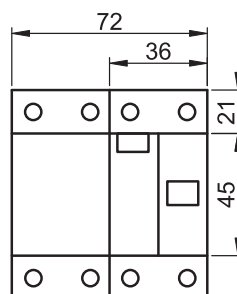
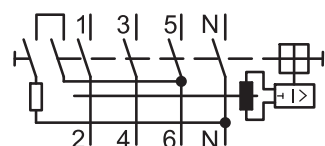
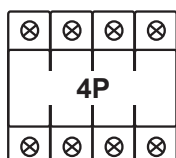

TÜV MEEI TEST DOCUMENTATION
M1 2792130 01

Blocuri cu protecție diferențială de tip TFG

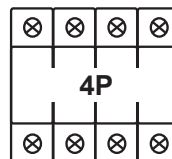
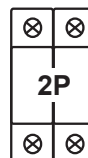
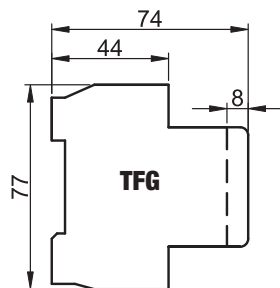
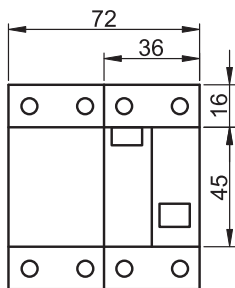
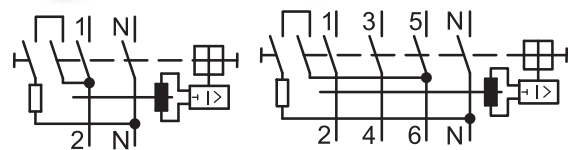

TRACON	I _n (A)	I _{Δn} (mA)
TFG2-16030	16	30
TFG2-16100	16	100
TFG2-16300	16	300
TFG2-25030	25	30
TFG2-25100	25	100
TFG2-25300	25	300
TFG2-40030	40	30
TFG2-40100	40	100
TFG2-40300	40	300
TFG2-63030	63	30
TFG2-63100	63	100
TFG2-63300	63	300
TFG4-16030	16	30
TFG4-16100	16	100
TFG4-16300	16	300
TFG4-25030	25	30
TFG4-25100	25	100
TFG4-25300	25	300
TFG4-40030	40	30
TFG4-40100	40	100
TFG4-40300	40	300
TFG4-63030	63	30
TFG4-63100	63	100
TFG4-63300	63	300

Legendă pictograme

F/O

RELEVANT STANDARD EN 61008-1

Adaptor TFGA cu protecție diferențială

TRACON		I _n (A)	I _{Δn} (mA)	P _{max}	IP..
TFGA-1		16	30	3.600 W	IP 40
TFGA-1F		16	30	3.600 W	IP 40
TFGA-4F		16	30	3.600 W	IP 44



Adaptorul TFGA echipat cu întrerupător sensibil la curent rezidual constituie unul din mijloacele cele mai moderne pentru protecție împotriva contactului indirect, uneori chiar împotriva atingerii directe. Protecția se activează, dacă intensitatea curentului rezidual în rețea depășește pragul critic. Fiind portativ, adaptorul se poate conecta la oricare rețea, care nu dispune de protecție diferențială integrată.

Adaptorul se anclanșează apăsând pe butonul RESET. Pentru verificarea funcționării corecte apăsați pe butonul TEST. Operațiunea trebuie să producă decuplarea prizei de la rețeaua de alimentare. În uz continuu recomandăm verificarea lunară a funcționării. După racordarea adaptorului la rețea, aparatul de protejat se conectează la priza de alimentare a adaptorului.

TÜV MEEI TEST DOCUMENTATION M1 2792130 01

ETL-SEMKO CERTIFICATE NO. 630406

Bloc cu protecție diferențială combinat cu dispozitiv de recuplare automată cu motor

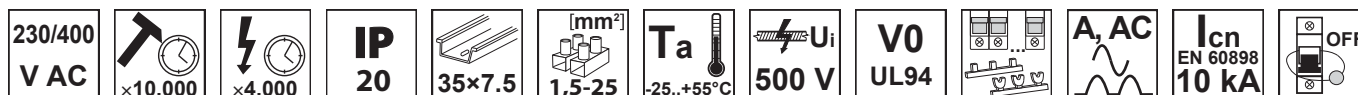

		TRACON			I _n (A)
		I _{Δn} = 30 mA	I _{Δn} = 100 mA	I _{Δn} = 300 mA	
		TFIG2-16030	TFIG2-16100	TFIG2-16300	16
		TFIG2-25030	TFIG2-25100	TFIG2-25300	25
		TFIG2-40030*	TFIG2-40100*	TFIG2-40300	40
		TFIG2-63030	TFIG2-63100	TFIG2-63300	63
		TFIG4-16030	TFIG4-16100	TFIG4-16300	16
		TFIG4-25030	TFIG4-25100	TFIG4-25300	25
		TFIG4-40030	TFIG4-40100*	TFIG4-40300	40
		TFIG4-63030	TFIG4-63100	TFIG4-63300*	63
	TFIG4-80030	TFIG4-80100	TFIG4-80300	80	



* În cazul comenzilor pentru variante care nu se află pe stoc timpul de livrare este de 4 săptămâni

Dispozitivul se folosește pentru recuplarea aparatelor care au declanșat datorită apariției curenților reziduali de valori mari sau supracurenți datorati fenomenelor atmosferice, după scăderea curentului alternativ sau curentului continuu pulsatoriu de defect din circuit la un nivel adecvat. Se recomandă utilizarea produsului în acele locuri unde decuplarea dispozitivelor de protecție produce oprirea pe o perioadă lungă de timp din cauza sosirii greoaie a echipajelor de intervenție (Stații de telecomunicație, semnalizare control, echipamente de comutare la distanță). De multe ori cauza ce a produs declanșarea dispare rapid și în aceste cazuri oprirea este nejustificată cauzând pierderi însemnate.

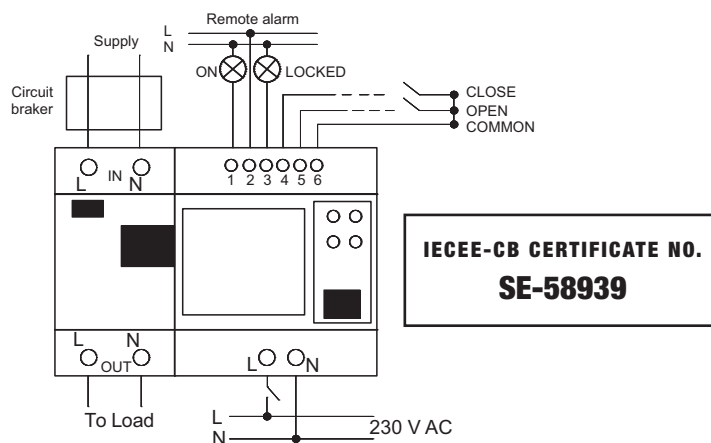

**IECEE-CB CERTIFICATE NO.
SE-58939**

Instalarea și reglarea dispozitivului de recuplare se realizează ușor. Pentru funcționare este suficient a culisa în lateral capacul convex pentru alegerea modului automat de funcționare.

Dacă în decursul numărului de recuplări setate dispozitivul (1-8) nu poate recupla blocul de protecție diferențială, atunci rămâne în stare blocată (declanșată). După restabilirea funcționării normale a rețelei, blocul de protecție diferențial se poate cupla și manual. În cazul lucrărilor de întreținere operatorul trebuie să fixeze întrerupătorul culisant în poziția OFF (oprit) înainte de decuplare, în caz contrar aparatul va recupla automat! În cazul unor nevoi speciale se poate comanda și varianta care se poate zăvorî pentru împiedicarea recuplărilor nedorite.

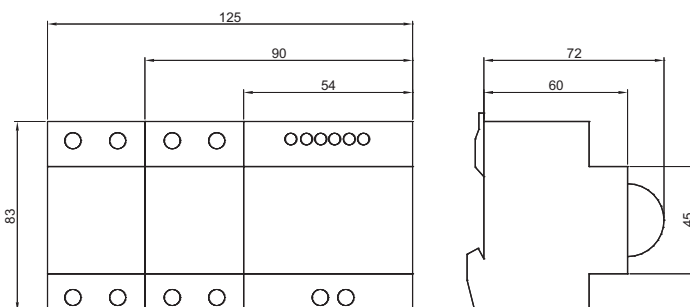

Date tehnice	Bloc de protecție diferențială	Dispozitiv de recuplare automată cu motor
Setarea numărului de recuplări	–	1, 2, 4, 6, 8
Timp de declanșare /Timp de decuplare	0,1 s	1 s
Timp de cuplare	–	2 s
Setarea temporizării la recuplare	–	10 - 30 - 60 - 120 - 180 s
Indicator LED pentru semnalizarea funcționării	–	Verde - cuplat ; roșu – decuplat; roșu intermitent dispozitivul urmează să recupleze
Conectare și deconectare manuală	Cu pârghie de acționare	Comutator frontal, convex
Sarcina utilă contacte auxiliare	–	250 V AC, 5 A
Intrări pentru comanda de la distanță	–	NC / NO / CO

Contactoare de instalații

230/400 V AC	x1.000.000	x30.000	IP 20	35x7.5	[mm ²] 1,5-25	Ta -25..+55°C	U_i 500 V	V0 UL94	ON-OFF-ON... sc/h x360	Legendă pictograme	F/0
-----------------	------------	---------	--------------	--------	------------------------------	-------------------------	-------------------------------	-------------------	------------------------------	---------------------------	------------

TRACON	U _m	I _n (A)	I _e			NC NO
			AC1/AC7a	AC3 (400V)	AC7b	
THK2-20-24	24 V AC	20 A	20	-	7	2 NO
THK2-20-24/1NO+1NC/	24 V AC	20 A	20	-	7	1NO+1NC
THK2-20	230 V AC	20 A	20	-	7	2 NO
THK2-20/1NO+1NC/	230 V AC	20 A	20	-	7	1NO+1NC
THK2-32-24	24 V AC	32 A	32	-	12	2 NO
THK2-32	230 V AC	32 A	32	-	12	2 NO
THK2-40-24	24 V AC	40 A	40	-	15	2 NO
THK2-40	230 V AC	40 A	40	-	15	2 NO
THK3-20-24	24 V AC	20 A	20	5	7	3 NO
THK3-20	230 V AC	20 A	20	5	7	3 NO
THK3-32-24	24 V AC	32 A	32	5.5	12	3 NO
THK3-32	230 V AC	32 A	32	5.5	12	3 NO
THK3-40-24	24 V AC	40 A	40	7	15	3 NO
THK3-40	230 V AC	40 A	40	7	15	3 NO
THK4-20-24	24 V AC	20 A	20	5	7	4 NO
THK4-20	230 V AC	20 A	20	5	7	4 NO
THK4-32-24	24 V AC	32 A	32	5.5	12	4 NO
THK4-32	230 V AC	32 A	32	5.5	12	4 NO
THK4-40-24	24 V AC	40 A	40	7	15	4 NO
THK4-40	230 V AC	40 A	40	7	15	4 NO
THK4-63	230 V AC	63 A	63	15	20	4 NO
THK4-63-24	24 V AC	63 A	63	15	20	4 NO
THK4-63/2NO+2NC/	230 V AC	63 A	63	15	20	2NO+2NC
THK4-63-24/2NO+2NC/	24 V AC	63 A	63	15	20	2NO+2NC

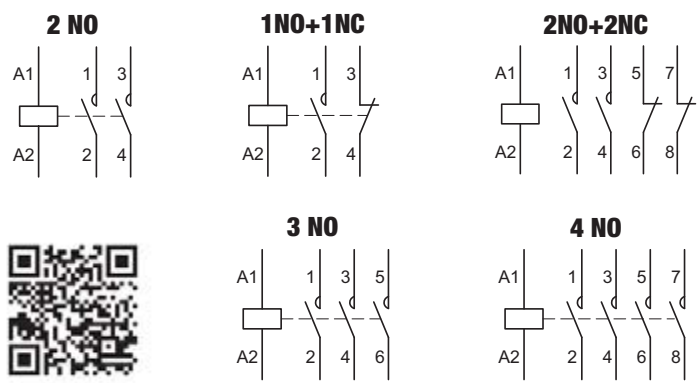

THK2-20

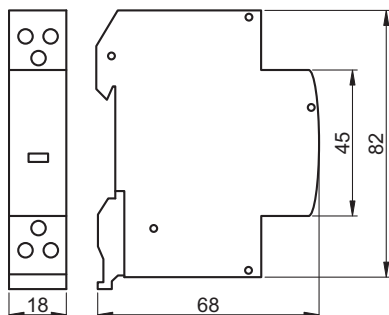

THK2-32, 2-40, 3-20, 4-20

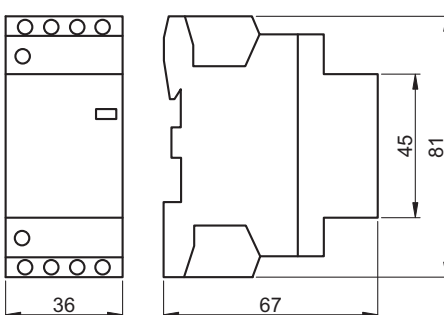

THK3-32, 3-40, 4-32, 4-40, 4-63

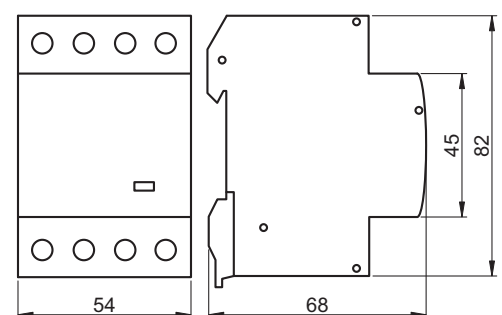

Automat de scară

230 V AC	1-2,5 mm²	IP 20	Ta -20..+55°C	35x7.5	1xCO	500 V	V0 UL94	Legendă pictograme	F/0
-----------------	-----------------------------	--------------	-------------------------	---------------	-------------	--------------	----------------	---------------------------	------------

TRACON		P_s	I_n	L	Σ	P_{max}	
TLA-3	30 sec – 12 min	1 VA	16 A (cos φ = 1)	max. 250 m	max. × 50	max. 2.300 W	max. 800 W
NARS	30 sec – 20 min	1.5 VA	16 A (cos φ = 1)	max. 250 m	max. × 50	max. 2.000 W	max. 400 W

Aplicații:

- temporizarea decuplării iluminatului pe coridoare, la intrare, în casa scării, săli, hale sau temporizarea decuplării ventilatoarelor (toaletă, baie, e.t.c.)

RELEVANT STANDARD EN 60730

RELEVANT STANDARD EN 60669-2

Conexiune cu 3 conductoare

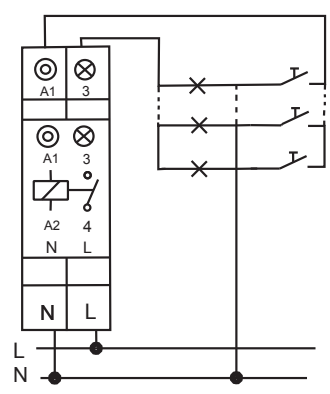

Max. 50 buc

Conexiune cu 4 conductoare

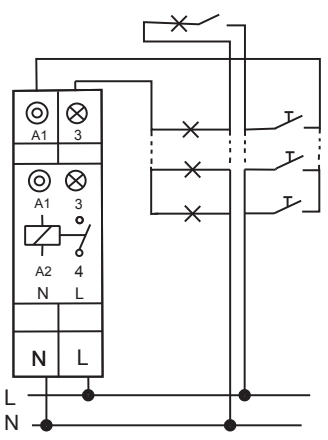

Conexiune cu 3 conductoare

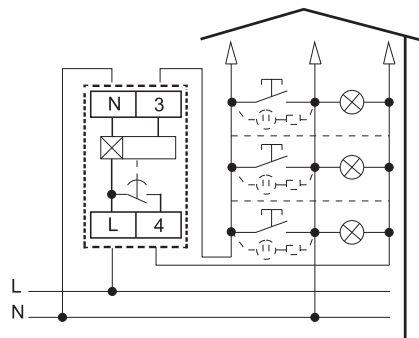

Max. 50 buc

Conexiune cu 4 conductoare

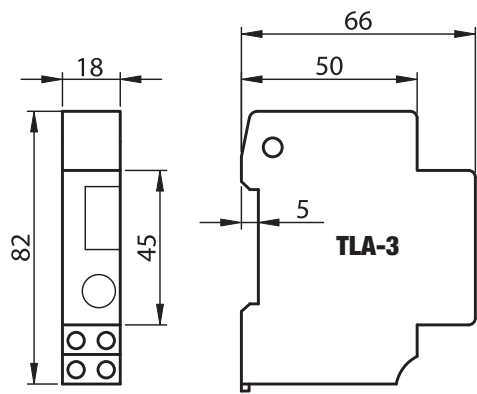
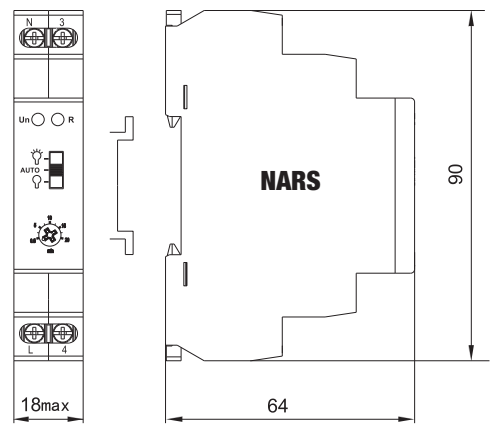
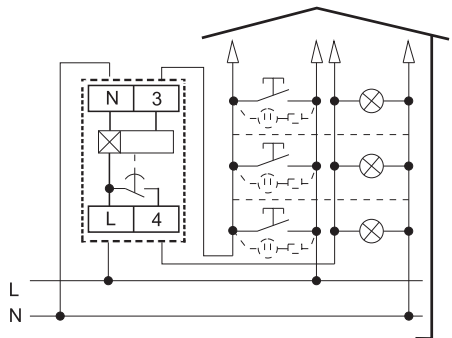

Releu de impuls

$\times 10^5$
 $\times 10^5$
 P_m 0,02 VA
 IP 20
 [mm²] 0,75-4
 35x7.5
 T_a $-25..+55^{\circ}\text{C}$
 U_i 500 V

Legendă pictograme
 F/0

TRACON	U _m	P _{max}		$\cos\phi=1$	$\cos\phi=0,6$
IMP-12	12 V AC	max. 3.500 W	max. 1.300 W	$\times 100.000$	$\times 50.000$
IMP-24	24 V AC	max. 3.500 W	max. 1.300 W	$\times 100.000$	$\times 50.000$
IMP-230	230 V AC	max. 3.500 W	max. 1.300 W	$\times 100.000$	$\times 50.000$
NARIMP	AC/DC12V-240V	max. 2.000 W	max. 900 W	500.000	250.000



IMP-..

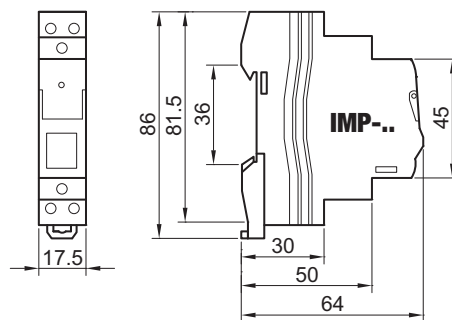
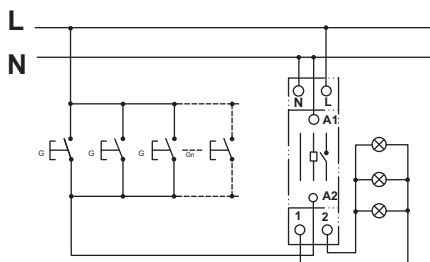

Aplicație

Releu de impuls se poate comanda cu ajutorul butoanelor din diferite locuri. Datorită înlocuirii comutatoarelor cruce cu comanda prin butoane (practic prin conectarea fără limitare pe două conductoare paralele), montajul este mult mai transparent și mai rapid pentru electrician.



NARIMP

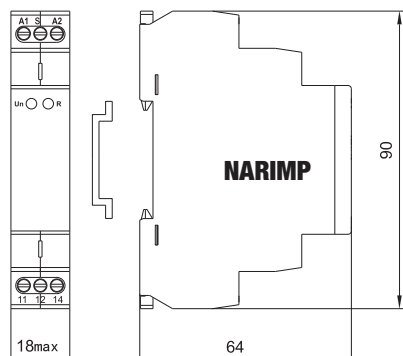
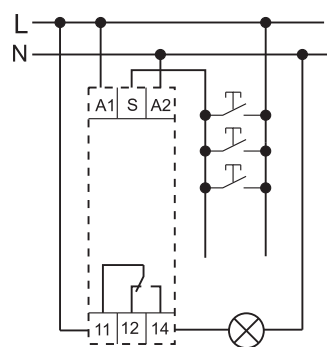

Sonerii

P_m 0,05 VA
 50/60 Hz

 IP 20
 [mm²] 1,0-10
 35x7.5
 T_a $-25..+55^{\circ}\text{C}$
 U_i 500 V



TRACON	U _m		
C60-CSEN	230 V AC	60 dB	max. 60 min.
C60-CSEN-24	24 V AC	60 dB	max. 60 min.
C60-CSEN-12	12 V AC	60 dB	max. 60 min.
C60-CSEN-8	8 V AC	60 dB	max. 60 min.

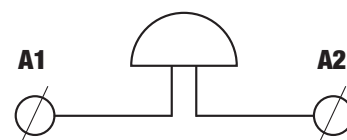
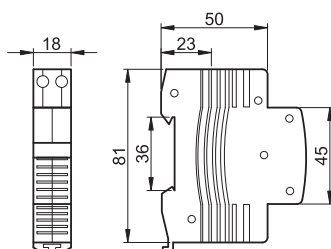

Transformator de siguranță (pt. sonerii)

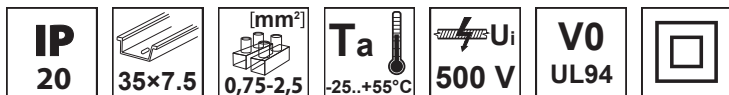

TRACON	P_s	U_{pr}	U_{sec}	I_{sec}
BT-8/1	max. 8 VA	230 V AC	4, 8, 12 V AC	0,66 A
BT-8/2			8, 12, 24 V AC	0,33 A

Transformator cu tensiune foarte joasă de siguranță. Asigură tensiuni mici de alimentare care nu sunt periculoase. În afara alimentării soneriilor obișnuite se poate utiliza ca sursă de alimentare pentru aparate electronice.

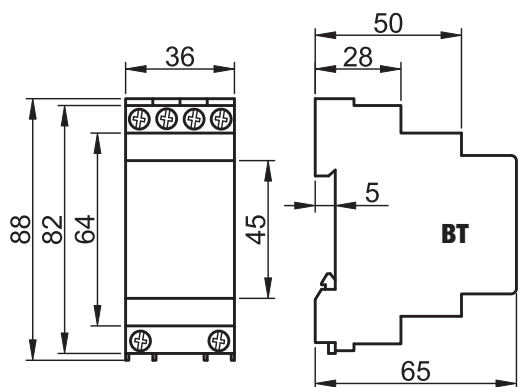

RELEVANT STANDARD
EN 61558-2-8

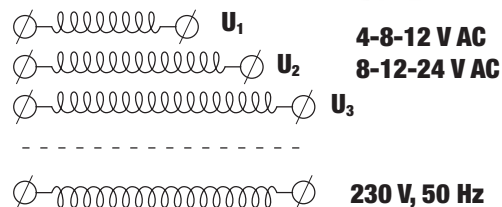

Prize de tablou

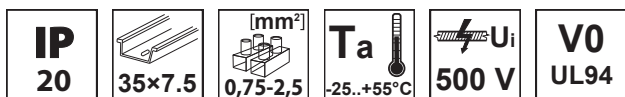

TRACON	I_n (A)	U_n
C60-DA0	16	250 V AC
C60-DA	16	250 V AC

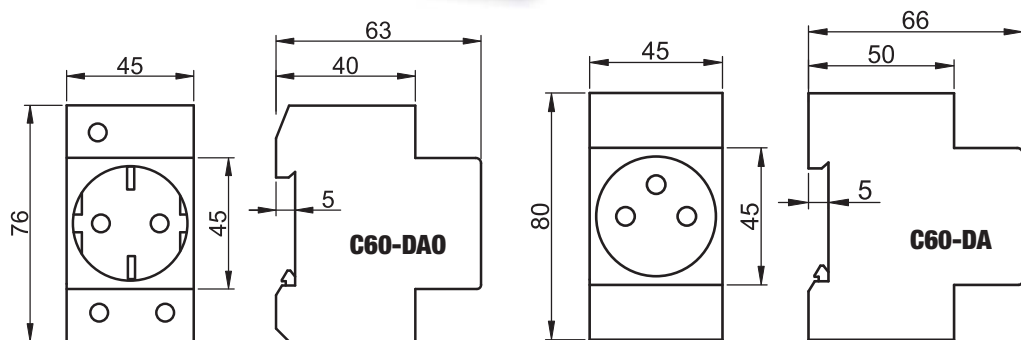

RELEVANT STANDARD MSZ 9872
 RELEVANT STANDARD IEC 60884-1
 TÜV MEEI TEST DOCUMENTATION 28208191 001

Prize și întrerupătoare PT

230 V AC	V1 UL94	IP 54	[mm ²] 1-2,5	Ta -25...+55°C	U _i 500 V
-------------	------------	----------	-----------------------------	-------------------	-------------------------

Legendă pictograme **F/0**



TRACON	SHUKO	FRENCH	F/0
TR-PH01	×1	-	-
TR-PHF01	-	×1	-
TR-PH02	×2	-	-
TR-PHF02	-	×2	-
TR-PH03	×1	-	101
TR-PHF03	-	×1	101
TR-PH08	×1	-	106
TR-PHF08	-	×1	106
TR-PH03V	×1	-	101
TR-PHF03V	-	×1	101
TR-PH08V	×1	-	106
TR-PHF08V	-	×1	106
TR-PH09V	×1	-	2×101
TR-PHF09V	-	×1	2×101
TR-PH10V	×1	-	2×106
TR-PHF10V	-	×1	2×101
TR-PH09	×1	-	2×101
TR-PHF09	-	×1	2×101
TR-PH10	×1	-	2×101
TR-PHF10	-	×1	2×101
TR-PH04	-	-	102
TR-PH05	-	-	101
TR-PH05L*	-	-	101
TR-PH06	-	-	106
TR-PH06L*	-	-	106
TR-PH07	-	-	N101
TR-PH07L*	-	-	N101
TR-PH05-2	-	-	2×101
TR-PH06-2	-	-	2×106

* cu lumină de semnalizare

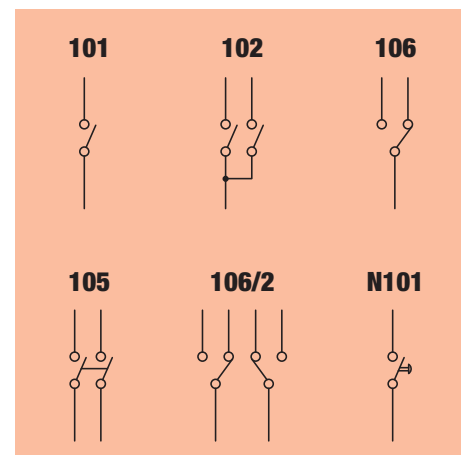
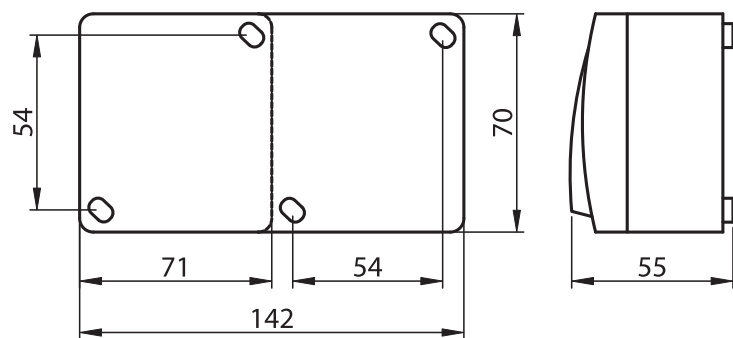

RELEVANT STANDARD
EN 60669-1

TÜV MEEI TEST DOCUMENTATION
28208176 001

Familia de prize și întrerupătoare TTK

230 V AC	V1 UL94	IP 20	1-2,5	Ta -25..+55°C	500 V
--------------------	-------------------	-----------------	--------------	-------------------------	--------------

Legendă pictograme **F/0**

TRACON

TTK-11	TTK-12	TTK-13*	TTK-21	TTK-31	TTK-32
SCHUKO	FRENCH	NO EARTH*	(RJ11 6/4) Telephone	9,5 mm TV	9,5 mm TV+FM

TRACON

TTK-01	TTK-02	TTK-03	TTK-04B	TTK-04L	TTK-04W	TTK-05	TTK-06	TTK-07
101	106	102	N101	N101	N101	2x101	105	2xN101

* Se recomandă pentru înlocuire de prize fără protecție

101 	102 	105 	106 	N101
----------------	----------------	----------------	----------------	-----------------

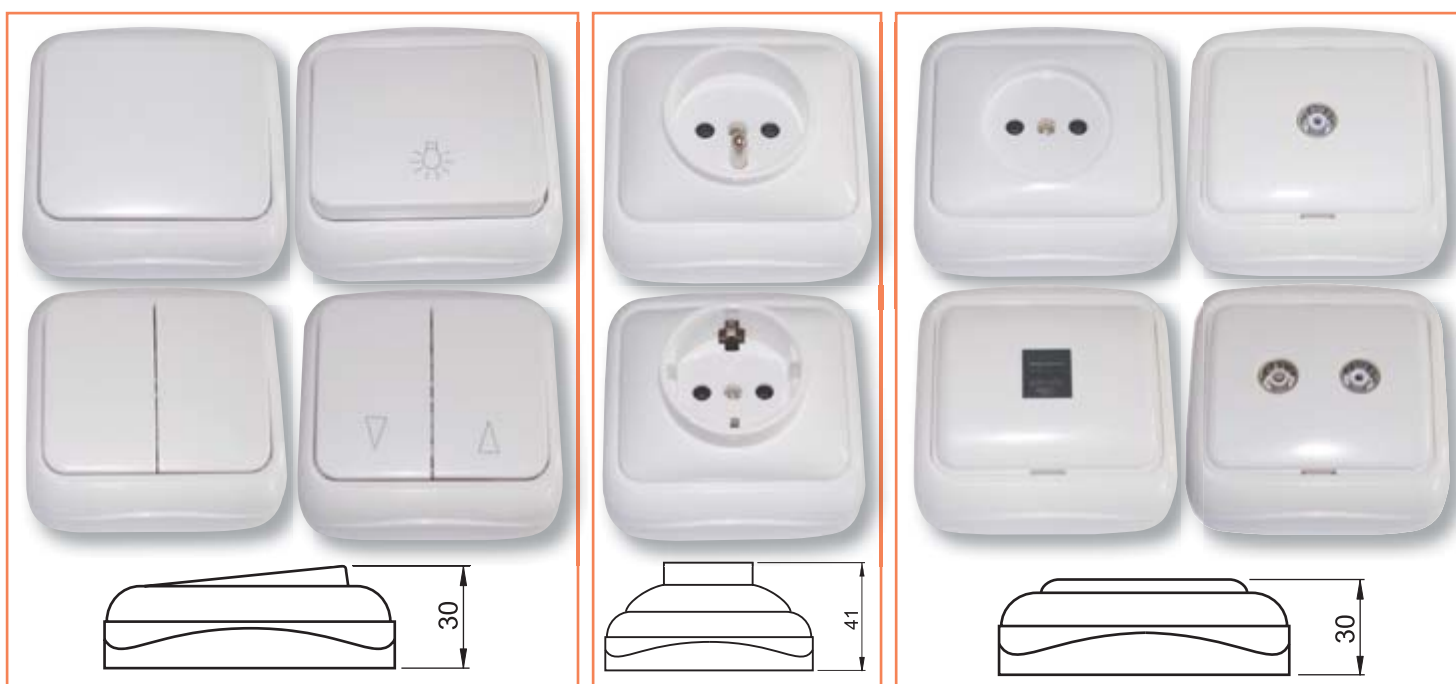
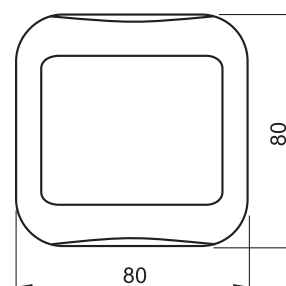

RELEVANT STANDARD
EN 60669-1

RELEVANT STANDARD
IEC 60884-1

RELEVANT STANDARD
MSZ 9871-2

TÜV MEEI TEST DOCUMENTATION
28208176 001

Familia de prize și întrerupătoare TFK

230 V AC	V1 UL94	IP 20	[mm ²] 1-2,5	Ta -25..+55°C	U _i 500 V	50/60 Hz
-------------	------------	----------	-----------------------------	------------------	-------------------------	----------

Legendă pictograme **F/O**

TRACON

TFK101	TFK101B	TFK102	TFK105	TFK106	TFKSCH	TFKSCH-2	TFKSCH-3
× 1 10 AX/250 V IP 20, (101)	× 1 10 AX/250 V IP 20, (N101)	× 1 10 AX/250 V IP 20, (102)	× 1 10 AX/250 V IP 20, (2×101)	× 1 10 AX/250 V IP 20, (106)	× 1 16 A/250 V, IP 20	× 2 16 A/250 V, IP 20	× 3 16 A/250 V, IP 20

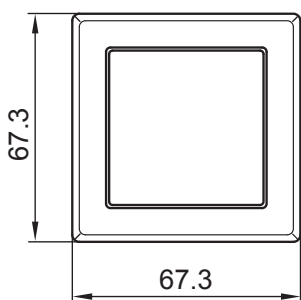

TFK...

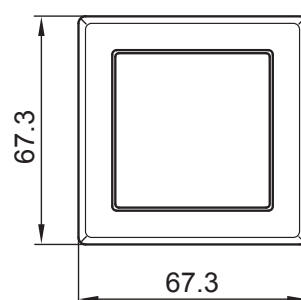

TFKSCH..

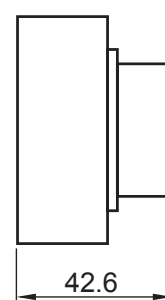

TFK101B



TFK102



TFK105



TFKSCH

FAMILIA DE ÎNTRERUPĂTOARE FĂRĂ FIR



Căutați noutățile în magazinul virtual !

Priză ST cu CP lateral, cu port USB

230 V AC	V1 UL94	IP 20	[mm²] 1-2,5	Ta -25..+55°C	U_i 500 V	50/60 Hz
-----------------	----------------	--------------	----------------------------------	-------------------------	-------------------------------	-----------------

Legendă pictograme **F/0**

TRACON

USB-21



× 1
16 A/250 V,
IP 20

USB:5V, 2100mA





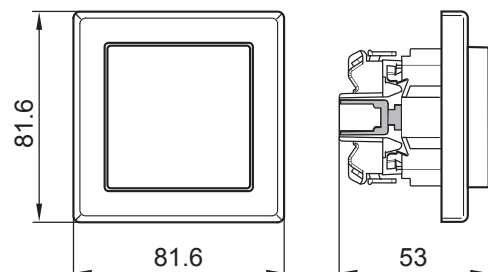



SCHUKO + USB



Sonerie pentru școală

U_i 500 V	50/60 Hz	[mm²] 0,75-2,5	Ta -25..+55°C	IP 20
-------------------------------	-----------------	-------------------------------------	-------------------------	--------------

Legendă pictograme **F/0**

TRACON	U _m	I _n		 [h]	H (mm)	W (mm)	D ₁ (mm)	D ₂ (mm)	d (mm)
BELL8S 	8 V AC	0,33 A	65 dB	max. 60 min.	148	72	36	36	76
BELL8 	8 V AC	0,55 A	85 dB	max. 60 min.	220	124	47	61	120
BELL24 	24 V AC	0,17 A	85 dB	max. 60 min.	220	124	47	61	120
BELL230 	230 V AC	0,03 A	85 dB	max. 60 min.	220	124	47	61	120

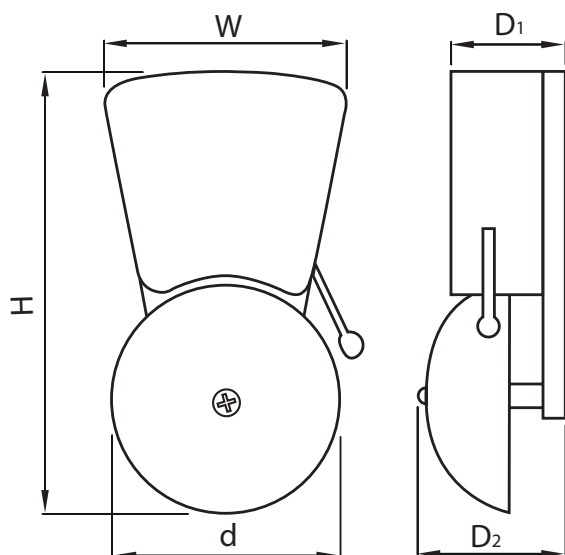

BELL8, BELL24, BELL230

BELL8S

Detector monoxid de carbon

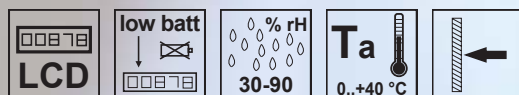

Concentrația de gaz CO	30 ppm	50 ppm	100 ppm	300 ppm
Cerințele standardului EN 50291	Nu alarmează	60 - 90 min.	10 - 40 min.	<3 min.
Rezultatele măsurătorilor pe baza raportului de încercare R-546875 TÜV SÜD	Nu alarmează	66 - 71 min.	26 - 33 min.	64 - 85 s
Rezultatele măsurătorilor pe baza raportului de încercare G/265/2015 Szenzortechnika Kft.	Nu alarmează	71 - 72 min.	20 min.	31 - 50 s

Cu ajutorul detectorilor cu dimensiuni compacte poate fi detectat monoxidul de carbon în aerul din locuință (un gaz toxic incolor și inodor). Monoxidul de carbon este rezultatul arderii incomplete care poate ajunge în locuință datorită echipamentelor de încălzire defecte și poate provoca chiar accidente mortale prin asfixiere. Detectorul avertizează optic și acustic în 4 trepte dacă concentrația gazului depășește o valoare prestabilită, protejând astfel sănătatea locatarilor din apartament. Aparatul nu oferă însă protecție împotriva efectelor cronice ale monoxidului de carbon și nu asigură protecție completă împotriva riscului specific! Utilizarea acestui produs nu înlocuiește instalarea și întreținerea corespunzătoare a echipamentelor de încălzire precum și asigurarea unei ventilații corespunzătoare!

Element senzitiv: celulă electrochimică
 Alimentare: Baterie AA 1,5 V 3 buc
 Consum de curent: în stare de repaus: <80 µA
 în stare de funcționare: 0,4 - 1,5 mA
 Tip de alarmă: optică și acustică
 Afișaj (LCD): situație de bază: PPM, temperatura exterioară, starea bateriei
 alarmare/test: ERR – eroare; --- - test; HCO – Valoare ridicată CO
 Semnalizare optică (LED): Funcționare (verde), eroare (galben), alarmare (roșu)
 Timp de răspuns: 5 s
 Buton de test încorporat

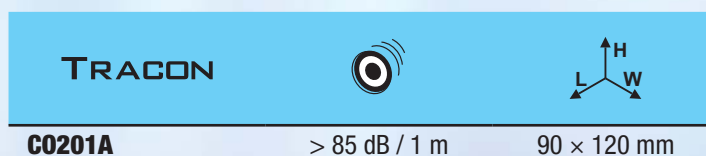

Durata de viață a unității de detecție, calculată de la prima punere în funcțiune este de 7 ani. Detectorul dispune de opțiunea afișării „Sfârșitul duratei de viață”.



Preveniți necazurile!

Detector de fum fără fir cu posibilitatea de transmisie

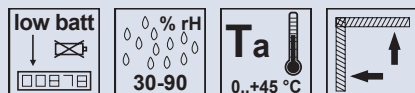

SD101LD > 85 dB / 3 m 433,92 MHz Ø125 × 125 × 48 mm

Cu ajutorul detectoarelor compacte fără fir poate fi semnalată prezența fumului în încăpere, astfel pot fi utilizate excelent în protecția persoanelor și a bunurilor împotriva incendiilor. Aparatul alarmează sonor și transmite deja un semnal la distanță unui receptor și în cazul unei detecții slabe a fumului, astfel și fumul generat în încăperi închise poate fi semnalat prin utilizarea funcției de transmisie.

Alimentare: Baterie AA 1,5 V 3 buc (emițător)
 Baterie 9 V 6LR61 1 buc (receptor)
 Tip de alarmă: optică și acustică
 Consum de curent: În stare de repaus(9 V): <12 μA
 Alarmare(9 V): <20 mA
 Semnalare (4,5 V): <230 μA

Buton de setare și de test încorporat



RELEVANT STANDARD
EN 14604:2005



Detector de fum fără posibilitatea de transmisie

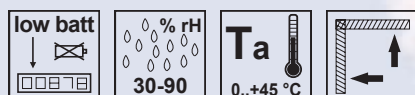

SD133A > 85 dB / 3 m 103×103×35 mm

Funcționarea detectoarelor în varianta constructivă simplă este identică cu a detectoarelor de fum fără fir, însă lipsește din aparat funcția de transmitere a semnalului.

Alimentare: Baterie 9 V 6LR61 1 buc (receptor)
 Tip de alarmă: optică și acustică
 Consum de curent: În stare de repaus(9 V): <12 μA
 Alarmare(9 V): <20 mA
 Semnalare (4,5 V): <230 μA

Buton de setare și de test încorporat



RELEVANT STANDARD
EN 14604:2005



**DATELE TEHNICE DETALIAATE ALE PRODUSELOR
 SE GĂSESC ÎN MAGAZINUL NOSTRU VIRTUAL!**