



































Pictogramele capului de tabel

U_n Tensiune nominală (V)	I_n Curent nominal (A)	P_{max} Puterea maximă	 Dimensiunea decupării (mm)
 Note, completări	 Volum (intensitate)	 Domeniu de reglaj	 Domeniu de reglaj
P_{th} Puterea de încălzire	T_h Temperatura pe suprafața elementului de încălzire	m³/h Debitul de aer	×17,5mm Rânduri×Module
 Ușă fumurie	 Ușă albă	 Ușă transparentă	 Cutii de distribuție fără ușă
N/PE Conține bară N/PE	 Încuietoare (buc)	×17.5 Număr module	VDC VAC A Date electrice contacte
 Filet	 Încovoiere	F_b↑ (N) Tracțiune	 Moment de strângere
 Culoare	 Intrări	 Lungime	 Secțiunea conductorului de racord
 Diametrul cablului	m Masa	 Volum	 Diametrul găurii
 Dimensiuni (LxWxH)	 Șine cupru		

Pictogramele datelor tehnice

600/1000 V AC/DC Tensiune nominală (V)	I_{n max.} 250 A Curent nominal (A)	 U_i 1 kV Tensiunea nominală de izolare	U_{test} 1min 5 kV Tensiune de încercare
 U_i 690 V Tensiunea maximă de izolare a aparatelor cu care se echează cutia:	IP 65 Grad de protecție	 Clasa I de protecție la atingere	 Clasa II de protecție la atingere
ABS Material: ABS	Cu Material: Cupru	STEEL Material: oțel	Al Material: aluminiu
N/PE Conține bară N/PE	 Unghiul de deschidere al ușii	 Se poate fixa pe șină de montaj 35×7.5	 Mod de fixare: pe soclu de beton
 Mod de fixare: pe suprafață verticală	[mm²] 1,5-2,5 Secțiunea conductorului de racord	 Contacte auxiliare	 Rezistență la șocuri mecanice
V2 UL94 Rezistență la foc conform UL 94	T_a -20..+80°C Temperatura mediului ambiant	 Rezistent UV	 Rulment cu bile



Cutii pe tencuială 2



Cutii sub tencuială 2



Cutii de distribuție PT, cu ușă plană 3



Cutii de distribuție ST, cu ușă plană 4



Cutii pe tencuială, IP 65 6



Cutii de distribuție fără ușă 6



Cutii de distribuție fără ușă, cu posibilitate de plombare 7



Capac de protecție 7



Cutii modulare de distribuție din material plastic 8



Cutii modulare de distribuție P.T.- metalice 9



Cutii modulare de distribuție metalice încastrate 9



Cutii metalice de distribuție-modulare 10



Acoperiș de ploaie pentru cutii metalice de distribuție-modulare 10

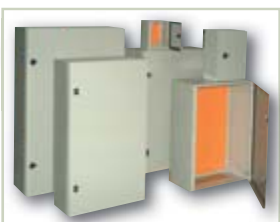

Cutii metalice de distribuție 11



Element pentru reglarea adâncimii, pentru cutii metalice tip TFE 12



Ușă de acces pentru cutii metalice 12



Grilaj de aerisire pentru cutii metalice 12



Încuietoare de siguranță din material plastic 13



Buzunar pentru proiecte 13



Trecere din cauciuc 13



Ventilatoare cu filtru de aer 14



Unități de încălzire compacte pentru dulapuri electrice 15



Unități compacte de încălzire cu ventilator montat 15



Termostate (Regulate de temperatură) 16



Higrostat 16



Clemă derivație din bara de distribuție 16

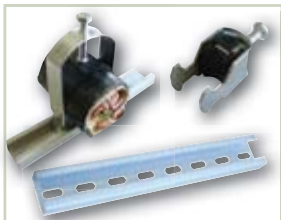

Cleme reglabile de fixare a caburilor 17



Distanțiere 17



Cutii pe tencuială



TRACON		$\times 17.5$	H (mm)	W (mm)	D (mm)
EDFK-4/1	EDFKN-4/1	4	200	110	70
EDFK-6/1	EDFKN-6/1	6	205	150	75
EDFK-8/1	EDFKN-8/1	8	205	190	75
EDFK-12/1	EDFKN-12/1	12	205	260	75
EDFK-18/1	EDFKN-18/1	18	220	365	75
EDFK-12/2	EDFKN-12/2	24	330	270	75
EDFK-12/3	EDFKN-12/3	36	475	310	85

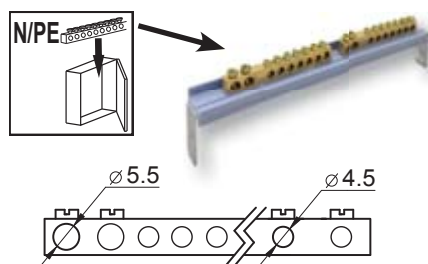

RELEVANT STANDARD
EN 61439-1

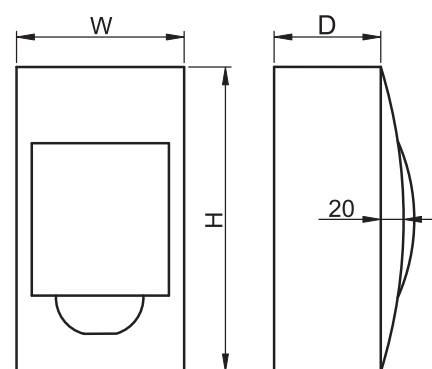

Cutii sub tencuială



TRACON		$\times 17.5$	H ₁ (mm)	W ₁ (mm)	D ₁ (mm)	H ₂ (mm)	W ₂ (mm)	D ₂ (mm)
EDS-4/1	EDSN-4/1	4	200	115	60	210	135	20
EDS-6/1	EDSN-6/1	6	200	160	60	210	170	20
EDS-8/1	EDSN-8/1	8	215	200	60	220	225	20
EDS-12/1	EDSN-12/1	12	200	260	60	220	280	20
EDS-18/1	EDSN-18/1	18	240	380	70	255	400	20
EDS-12/2	EDSN-12/2	24	320	270	70	350	300	20
EDS-12/3	EDSN-12/3	36	475	310	75	500	340	20

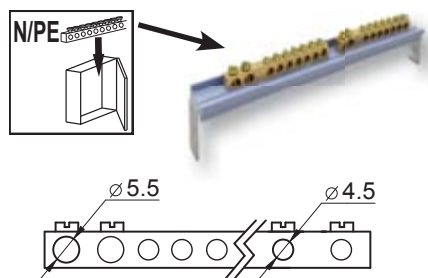

RELEVANT STANDARD
EN 61439-1

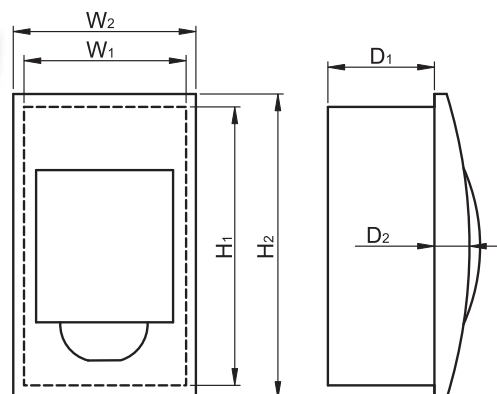

Cutii de distribuție PT, cu ușa plană



TRACON		x17.5	H (mm)	W (mm)	D (mm)
EDFKS-12/2	EDFKSN-12/2	24	345	305	75

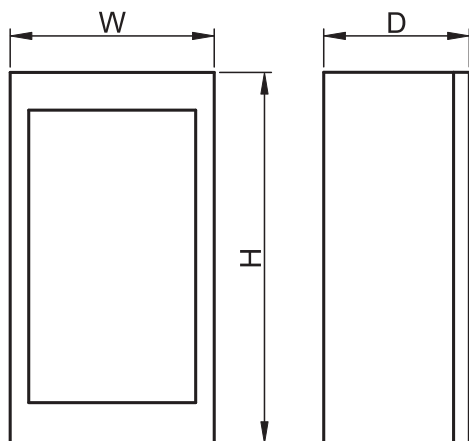

EDFKS-12/2



EDFKSN-12/2

RELEVANT STANDARD
EN 61439-3

RELEVANT STANDARD
EN 61439-1

MERGEȚI LA SIGUR!

- Gamă largă de produse
- Calitate sigură
- Recuplare automată ca opțiune

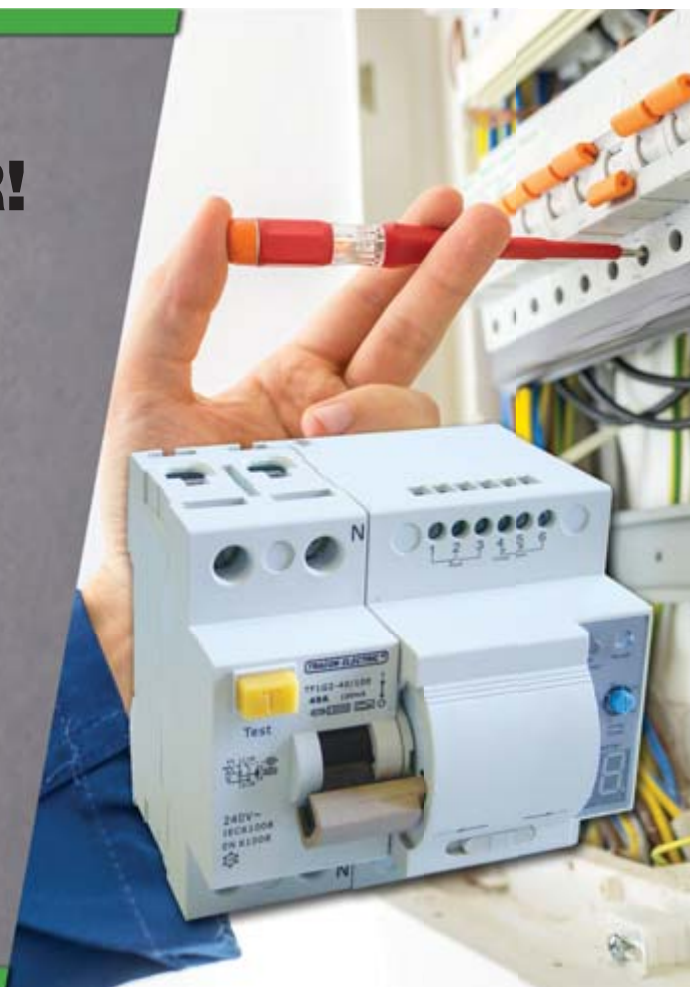

Cutii de distribuție ST, cu ușă plană



TRACON			ACCESORII				
			$H_1 \times W_1 \times D_1$ (mm)	$H_2 \times W_2 \times D_2$ (mm)			
EDSS-8/1	EDSSN-8/1	8	180×220×88	193×240×10	–	–	–
EDSS-12/1	EDSSN-12/1	12	240×305×80	262×330×10	max. 2 x NPE-Z-24	max. 1 x ED-TLT12	–
EDSS-12/2	EDSSN-12/2	24	395×305×85	420×330×17	max. 2 x NPE-Z-24	max. 2 x ED-TLT12	max. 1 x ED-SEP12
EDSS-12/3	EDSSN-12/3	36	545×305×85	570×330×17	max. 2 x NPE-Z-24	max. 3 x ED-TLT12	max. 2 x ED-SEP12
EDSS-18/1	EDSSN-18/1	18	270×440×85	300×465×17	max. 2 x NPE-Z-38	max. 1 x ED-TLT18	–
EDSS-18/2	EDSSN-18/2	36	480×440×90	505×465×17	max. 2 x NPE-Z-38	max. 2 x ED-TLT18	max. 1 x ED-SEP18
EDSS-18/3	EDSSN-18/3	54	655×440×90	685×465×20	max. 2 x NPE-Z-38	max. 3 x ED-TLT18	max. 2 x ED-SEP18
EDSS-18/4	EDSSN-18/4	72	860×440×95	880×465×20	max. 4 x NPE-Z-38	max. 4 x ED-TLT18	max. 3 x ED-SEP18

Cutia NU conține bară N/PE!

- Unghiul de deschidere al ușii 180°
- Direcția de deschidere a ușii poate fi inversată
- Consolă interioară care poate fi rotită
- Încuietore specială cu arc dublu
- Panoul frontal se poate plomba
- Preștanțări posterioare și laterale
- Accesorii plăci de separare
- Accesorii panouri frontale
- Accesorii bare N/PE



RELEVANT STANDARD
EN 61439-1

RELEVANT STANDARD
EN 61439-3

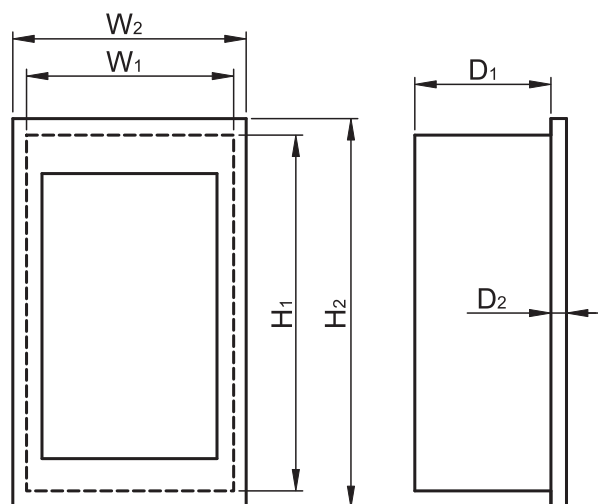





Accesorii pentru cutii de distribuție S.T.

Baretă izolată (N/PE)

230/400 V AC	I_n max. 100 A	U_i 500 V	Cu	IP 20	T_a -40..+85°C	V1 UL94
-----------------	------------------------	----------------	----	----------	---------------------	------------

 **Legendă pictograme** **H/0**

TRACON		\times 	I_n	 mm ²	L (mm)	H (mm)	W (mm)	d (mm)	 M
NPE-Z-24	6 × 9	24	max. 63 A	2,5-10 / 2,5-16	250	18,3	7,6	4×5,4 + 20×4,3	M5×20 + M6×4
NPE-Z-38	8 × 12	38	max. 100 A	2,5-16 / 4-25	360	26,5	13,7	10×7,5 + 28×5,2	M6×10 + M5×28

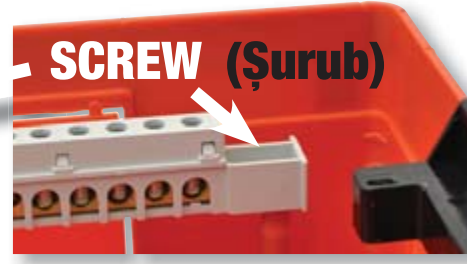
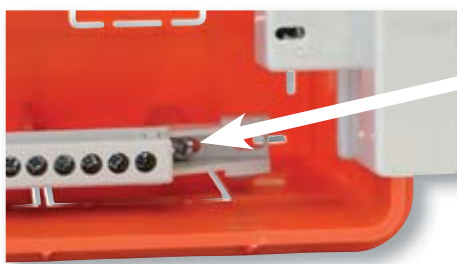
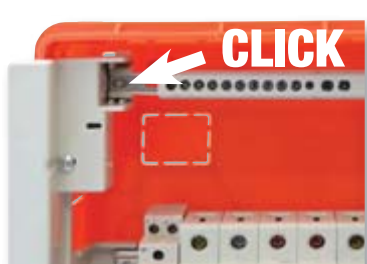
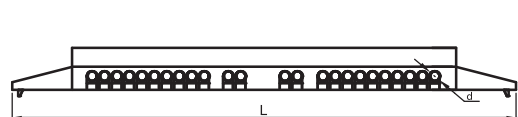

Panou frontal fără decupaj pt.cutii

T_a -25..+55°C	V0 UL94	ABS
---------------------	------------	-----



TRACON	\times 17.5 
ED-TLT12	12 mod.
ED-TLT18	18 mod.



Placă de separare,pt.cutii sub tencuială

T_a -25..+55°C	V0 UL94	ABS
---------------------	------------	-----



TRACON	\times 17.5 
ED-SEP12	12 mod.
ED-SEP18	18 mod.



Cutii pe tencuială, IP 65



TRACON	×17.5	H (mm)	W (mm)	D (mm)
EDFKIP65-4/1	4	210	140	100
EDFKIP65-8/1	8	210	215	100
EDFKIP65-12/1	12	260	300	140
EDFKIP65-18/1	18	285	410	140
EDFKIP65-12/2	24	415	300	140



RELEVANT STANDARD
EN 60439-1

RELEVANT STANDARD
EN 60439-3

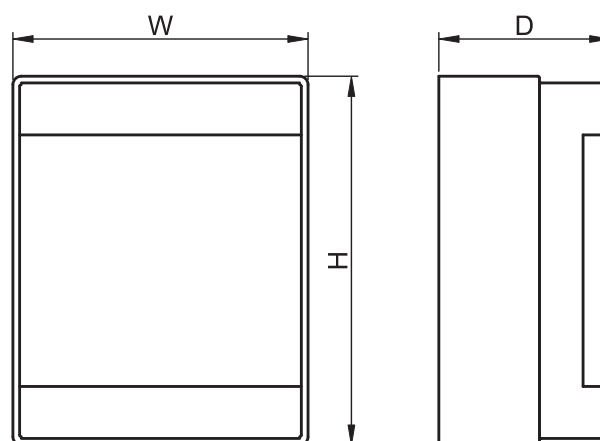

Cutii de distribuție fără ușa



TRACON	×17.5	H (mm)	W (mm)	D (mm)	N/PE
EDFK-1/1AN	1	130	32	62	–
EDFK-2/1AN	2	130	52	62	–
EDFK-3/1AN	3	130	65	62	–
EDFK-4/1AN	4	130	82	62	–
EDFK-8/1AN	8	160	160	62	–
EDFK-12/1AN	12	160	260	65	✓
EDFK-18/1AN	18	160	365	60	✓

RELEVANT STANDARD
EN 60439-1

RELEVANT STANDARD
EN 60439-3

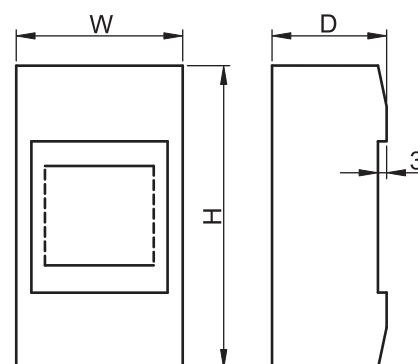

Cutii de distribuție fără ușă, cu posibilitate de plombare



TRACON		H (mm)	W (mm)	D (mm)
EDFK-1/1ANP	1	140	35	60
EDFK-2/1ANP	2	140	50	60
EDFK-4/1ANP	4	140	90	60
EDFK-8/1ANP	8	160	180	60

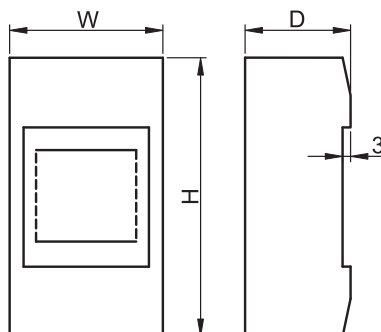



RELEVANT STANDARD
EN 60439-3

RELEVANT STANDARD
EN 60439-1

Capac de protecție



TRACON			
TDT	1	✓	-
TDT-2	1	-	✓

Capacele asigură protecție izolată pentru câte un element înseriabil cu lățime egală cu cea a unui modul. Clapeta de acționare a elementului va rămâne accesibilă și după aplicarea capacului protector. Capacele pot fi plombate, astfel ne putem convinge de starea neatinsă a elementului acoperit.

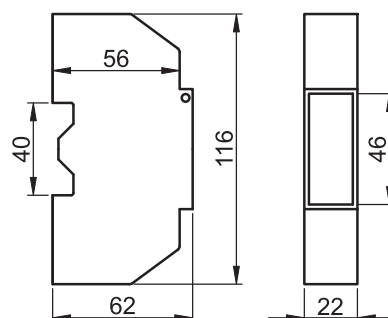



partea inferioară
închisă

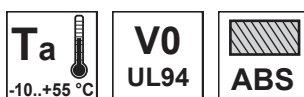

RELEVANT STANDARD
EN 60439-1

Modul obturator pentru cutii de distribuție



TRACON	
EDTM	$8 \times 1/2 + 2 \times 1 = 6$

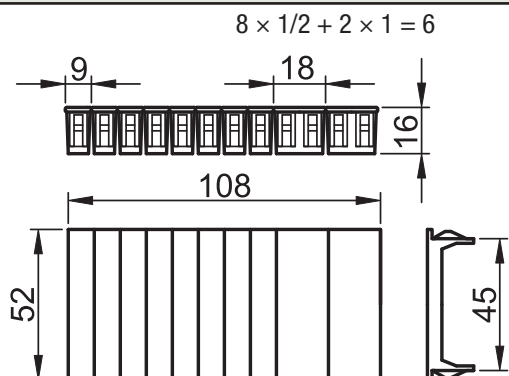

Servește acoperirii eventualelor spații rămase libere între modulele din cutie. Pe lângă aspectul estetic, ridică nivelul protecției împotriva atingerii accidentale, respectiv împotriva murdăriei. Setul se compune din 10 module, dintre care 8 "jumătăți" de 9 mm fiecare, respectiv 2 "întregi" de 18 mm fiecare. Lățimea dorită se obține prin ruperea numărului necesar de module.

Cutii de distribuție din material plastic



TRACON				H (mm)	W (mm)	D (mm)	×17,5mm Σs	X	N/PE
				280	210	130	1 × 8	1	–
				330	250	130	2 × 9	1	–
				400	300	165	2 × 12	2	–
		–	–	400	300	195	–	2	–
				500	400	175	3 × 17	2	–
				600	400	200	4 × 17	2	–
				700	500	245	4 × 22	2	–

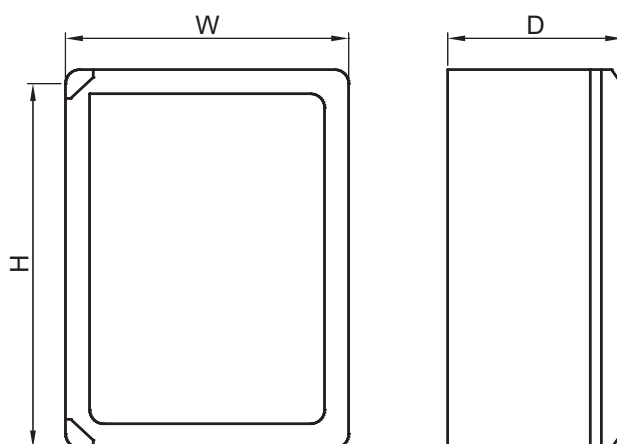

RELEVANT STANDARD
EN 62208

RELEVANT STANDARD
EN 60439-1



Cutii modulare de distribuție P.T.- metalice

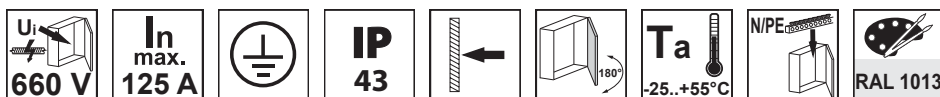

TRACON	×17,5mm Σs	×17,5	H (mm)	W (mm)	D (mm)
EDFKF-16/1	1×16	16	305	445	110
EDFKF-16/2	2×16	32	455	445	110
EDFKF-16/3	3×16	48	605	445	110
EDFKF-16/4	4×16	64	755	445	110

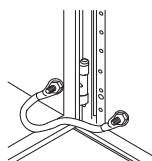
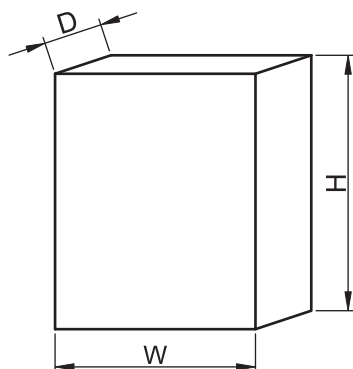

RELEVANT STANDARD
EN 62208

RELEVANT STANDARD
EN 60439-1

Cutii modulare de distribuție metalice încastrate

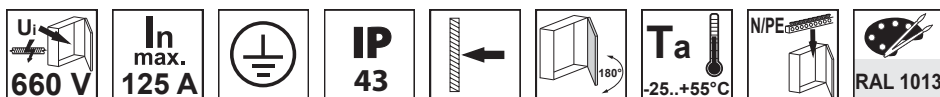

TRACON	×17,5mm Σs	×17,5	H (mm)	W (mm)	D (mm)
EDSF-16/1	1×16	16	326	464	115
EDSF-16/2	2×16	32	476	464	115
EDSF-16/3	3×16	48	626	464	115
EDSF-16/4	4×16	64	776	464	115

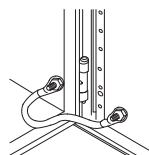
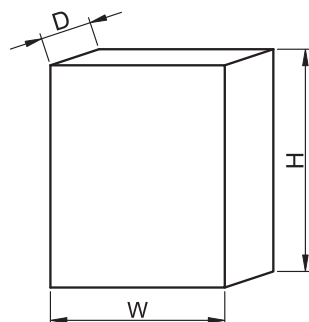

RELEVANT STANDARD
EN 62208

RELEVANT STANDARD
EN 60439-1



CITIȚI CODUL !

- Vezi noutățile noastre
- Fiți informat

Gama de produse se dezvoltă continuu și rapid!
Catalogul nostru reflectă situația din Octombrie 2017.
Pentru informații actualizate vizitați pagina
noastră de internet!

Cutii metalice de distribuție-modulare

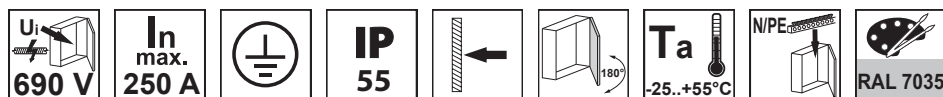

TRACON		$\times 17,5\text{mm}$ Σs	$\times 17,5$ 	H (mm)	W (mm)	D (mm)
TFE403020M	1	2x12	24	400	300	200
TFE504020M	2	3x16	48	500	400	200
TFE605020M	2	4x22	88	600	500	200
TFE806020M	2	5x27	135	800	600	200

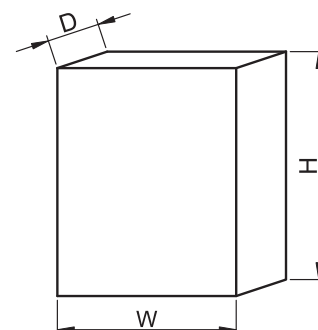
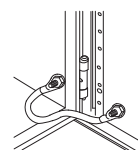

RELEVANT STANDARD
EN 60439-1

Acoperiș de ploaie pentru cutii metalice de distribuție-modulare

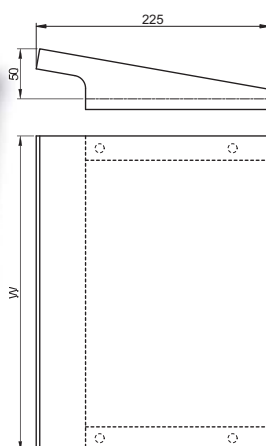

TRACON	W (mm)	H (mm)
TFE403020T	300	200
TFE504020T	400	200
TFE605020T	500	200
TFE806020T	600	200

În cazul amplasării cutiilor în exterior, pentru realizarea unei protecții mai bune, se folosește acoperișul de ploaie, care se poate monta ulterior pe partea superioară a cutiilor.

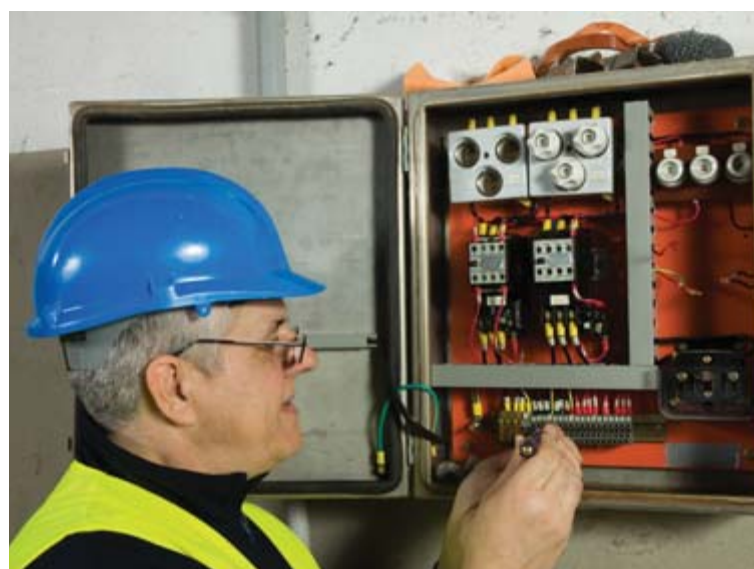

Cutii metalice de distribuție

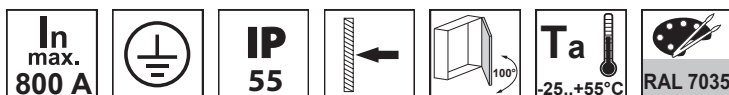

TRACON		H (mm)	W (mm)	D (mm)
TFE252015	1	250	200	150
TFE302515	1	300	250	150
TFE303015	1	300	300	150
TFE403015	1	400	300	150
TFE403020	1	400	300	200
TFE404020	1	400	400	200
TFE404025	1	400	400	250
TFE504015	1	500	400	150
TFE504020	1	500	400	200
TFE504025	1	500	400	250
TFE604020	2	600	400	200
TFE605015	2	600	500	150
TFE605020	2	600	500	200
TFE605025	2	600	500	250
TFE606025	2	600	600	250
TFE606030	2	600	600	300
TFE705020	2	700	500	200
TFE705025	2	700	500	250
TFE806020	2	800	600	200
TFE806025	2	800	600	250
TFE806030	2	800	600	300
TFE1006025	2	1000	600	250
TFE1008025	2	1000	800	250
TFE1008030	2	1000	800	300
TFE1008040	2	1000	800	400
TFE1208030	2	1200	800	300

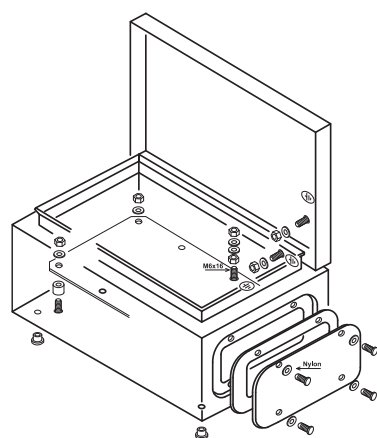
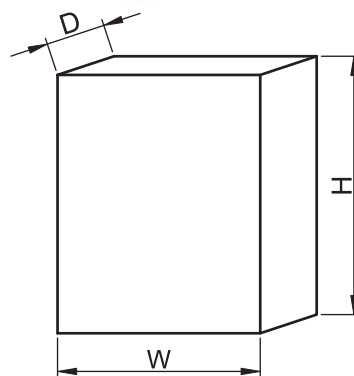

RELEVANT STANDARD
EN 60439-1

RELEVANT STANDARD
EN 62208

TÜV MEEI TEST DOCUMENTATION
28203644 001

Cutiile de distribuție de tip TFE sunt accesibile într-o gamă largă de dimensiuni. Datorită tehnicii bazate pe plăci de montaj, aparatele pot fi dispuse liber, după necesitate. Cadru metalic conferă rigiditate excelentă structurii, cutiile se livrează complete, cu ușă și contrapanou. Ușa are încuietore tip bară dublă, încuietorea de siguranță se poate comanda separat. Direcția de deschidere a ușii poate fi inversată prin întoarcerea cutiei sau montarea balamalelor pe partea opusă. Cutiile până la înălțimea de 500mm au o încuietore, peste această înălțime au două încuietori. Sarcina maximă admisă într-o cutie este de cel mult 800 A.

Accesorii



Element pentru reglarea adâncimii, pentru cutii metalice tip TFE

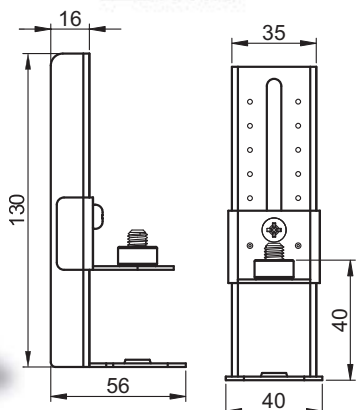

TRACON

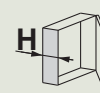

TFE-MA

40-110 mm

min. 200 mm

În multe cazuri aceasta oferă posibilitatea pozării cablurilor, respectiv motivul montării contrapanoului. Cu elementul pentru reglarea adâncimii, contrapanoul se poate distanța de spatele tabloului cu 50 –125 mm. Fixarea se realizează cu ajutorul șuruburilor M8 de pe spatele tabloului. Cu excepția cutiilor având adâncimea de 150mm, elementul de reglare al adâncimii se poate folosi pentru fiecare cutie (200-250-300-400 mm). Din punctul de vedere al cutiei, sub dimensiunea de 1000x600 se folosesc 4 șuruburi de fixare iar peste 6 buc de fixare a contrapanoului. Prin urmare, la folosirea elementului pentru reglarea adâncimii trebuie să alegem corect cantitatea necesară. Produsul are 1,5 mm grosime, cu suprafață profilată din oțel ambutisat, unitatea de ambalare din cauza celor amintite mai sus 2 buc/pachet.

Ușă de acces pentru cutii metalice

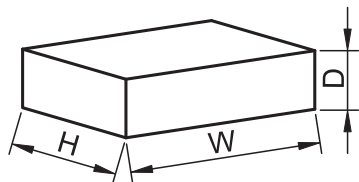
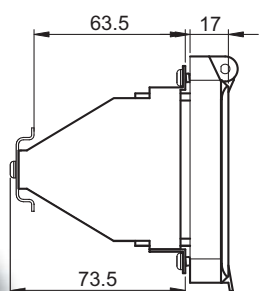

TRACON



H×W×D
(mm)



TFE-KA6

6

129×98×95

65×112 mm

TFE-KA8

8

162×98×95

65×148 mm

TFE-KA12

12

235×98×95

65×220 mm

Ușa de acces face posibilă accesarea aparatului modular din interiorul cutiilor, fără deschiderea ușii cutiilor metalice. Ca accesoriu pentru ușa de acces este adaptorul de fixare a șinei de montaj, cu ajutorul căruia aparatul se montează la o distanță corespunzătoare față de planul ușii. Se decupează cutia la dimensiunea corespunzătoare. Se montează ușa de acces în golul decupajului și se fixează cu șuruburi. Prin folosirea unor șuruburi cu cap găurit ușa de acces se poate plomba. Gradul de protecție IP 44, este asigurat de către garnitura situată pe suprafața de sprijin și de ușa de acces. Gradul de protecție împotriva atingerii directe este ridicat datorită obturatorilor care se pot rupe la diferite lățimi cu pasul de jumătate de modul.

Grilaj de aerisire pentru cutii metalice



IP
43

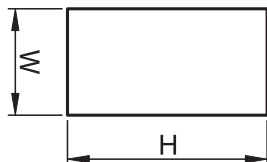

TRACON

W (mm)

H (mm)



TFE-SZ1

150

200

115×160 mm

TFE-SZ2

140

140

100×100 mm

TFE-SZ3



115

200

50×160 mm

Necesitatea ventilației poate proveni datorită căldurii degajată de aparat, respectiv a nivelului de umiditate ridicat. Dacă aceste valori sunt mai mari decât parametrii de funcționare al aparatelor, atunci cutia trebuie prevăzută cu grilaj de aerisire în vederea asigurării condițiilor corespunzătoare de funcționare. Capacitatea de ventilare se poate modifica în funcție de mărimea grilajului. În caz de nevoie se pot monta mai multe grile de ventilare pe o cutie. Se decupează cutia la dimensiunea corespunzătoare, după fixarea garniturii se montează grilajul cu ajutorul șuruburilor.

Încuietoare de siguranță din material plastic

TRACON		
TFE-ZM2	5 mm	22,5 mm
TFE-ZT	5 mm	22,5 mm



- Încuietoare cu corp din plastic, bucsă și limbă metalică, unghi de rotire 90°. După montare, cutia își păstrează gradul protecție IP 55
- Execuția cheii: Cheie universală (Cap din plastic, pană din metal)



TFE-ZT



TFE-ZM2



Buzunar pentru proiecte

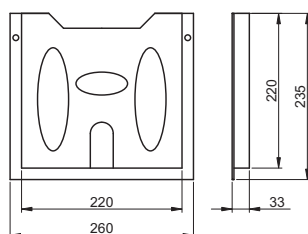

TRACON	
TFE-A4	A4

Conform prescripțiilor la montarea tablourilor de distribuție, proiectele și schemele de legături trebuie păstrate în siguranță. Buzunarul pentru proiecte este capabil să cuprindă aceste documente în format A4 și se poate fixa cu ajutorul benzii autoadezive situate spatele buzunarului. În funcție necesități se poate prinde și în șuruburi.



Trecere din cauciuc



TRACON	 Ø mm											A × B (mm)
	3,5-11	7-12	7-13	10-14	10-30	14-18	14-22	14-35	15-25	24-54		
EKBV-01	–	–	–	–	–	–	× 4	–	–	–	× 4	138 × 48
EKBV-02	–	× 2	–	–	× 8	–	–	–	–	–	× 10	216 × 84
EKBV-03	–	–	–	× 5	–	× 4	× 3	–	–	× 2	× 14	222 × 92
EKBV-04	× 2	× 5	–	–	–	× 12	× 5	× 1	–	–	× 25	222 × 92
EKBV-05	–	–	× 50	–	–	–	–	–	× 1	–	× 51	222 × 92



EKBV-01



EKBV-03

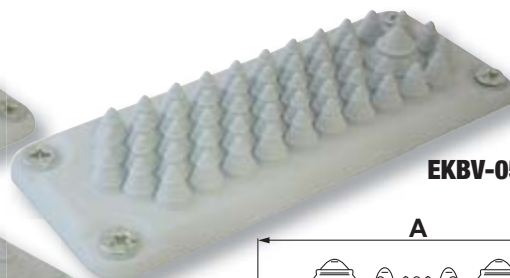

EKBV-05



EKBV-02



EKBV-04

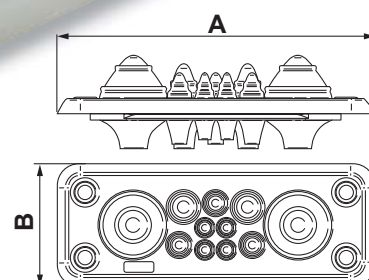

Ventilatoare cu filtru de aer

230
V AC



IP
54

Ta
-10..+55 °C

Legendă
pictograme H/O

TRACON	m³/h	I _n	P _{max}			A (mm)		C (mm)	D (mm)	E (mm)
V35	35/40* m³/h	0,07 A	12 W	31 dB (A)	V35-KNY	105	92	5	50	5
V43	43/55* m³/h	0,11 A	19 W	46 dB (A)	V43-KNY	150	124	5	61	5
V71	71/105* m³/h	0,11 A	19 W	46 dB (A)	V71-KNY	250	224	6	100	5
V150	150/170* m³/h	0,14 A	21 W	42 dB (A)	V150-KNY	150	125	5	50	5
V170	170/230* m³/h	0,28 A	41 W	54 dB (A)	V170-KNY	250	224	6	134	5
V215	215/255* m³/h	0,22 A	33 W	50 dB (A)	V215-KNY	250	221	7	115	5
V360	360/500* m³/h	0,34 A	64 W	54 dB (A)	V360-KNY	325	291	6	150	5
V375	375/500* m³/h	0,25 A	55 W	60 dB (A)	V375-KNY	325	291	7	150	5

* în cazul în care se utilizează orificiul de evacuare a aerului fără filtru



V43



V71, V170



V360

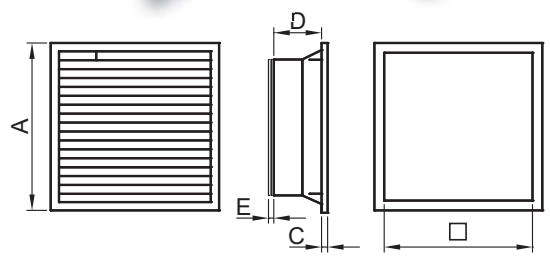

V35



V150



V215

RELEVANT STANDARD
EN 61335



V43-KNY



V71-KNY
V170-KNY



V360-KNY

TRACON	A (mm)		C (mm)	D (mm)	E (mm)
V35-KNY	105	92	5	25	-
V43-KNY	150	124	5	23	-
V71-KNY	250	224	6	25	-
V150-KNY	150	125	5	25	-
V170-KNY	250	224	6	25	-
V215-KNY	250	221	7	25	-
V360-KNY	325	291	6	26	-
V375-KNY	325	291	7	30	-

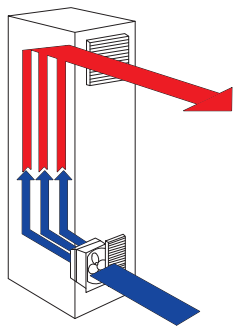

Recomandăm utilizarea noii familii de ventilatoare mai ales în aplicațiile industriale, special în dulapuri de distribuție, în camera serverelor, mai departe în acele locuri unde datorită funcționării dispozitivelor integrate, este necesară o ventilare sistematică. Montarea lor se face simplu și rapid, fără șuruburi, prin înclinetarea urechilor de prindere. Ventilatoarele și orificiile de evacuare a aerului sunt prevăzute din fabrică cu filtre foarte subțiri, care sunt menite să rețină picăturile de ploaie și particulele de praf mai mari de 10 microni, astfel se atinge un grad de protecție IP54. Prin întoarcerea ventilatorului direcția fluxului de aer se poate schimba după cum este necesar. Este util ca ventilatoarele să se monteze întotdeauna în treimea inferioară a dulapului de distribuție și întotdeauna trebuie utilizat împreună cu filtrul, precum și dotarea sistemului cu un termostat pentru a face posibilă realizarea unei ventilații automate.

Unități de încălzire compacte pentru dulapuri electrice

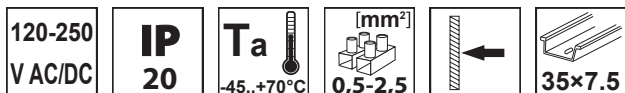

TRACON	P_{th} 	H (mm)	
FE15	15 W	65	300 g
FE30	30 W	65	300 g
FE45	45 W	65	300 g
FE60	60 W	140	400 g
FE75	75 W	140	500 g
FE100	100 W	140	500 g
FE150	150 W	220	700 g

Pentru prevenirea apariției condensului în dulapurile de distribuție se recomandă utilizarea unităților de încălzire, care se pot instala ușor. Acest lucru poate fi important în special la dulapurile montate în exterior, în perioada iernii, sau la instalarea comenzilor electronice sensibile. Unitățile de încălzire se pot alege de diferite puteri 15-150W. Montarea lor se face simplu, deoarece dispozitivele se prind pe șină de montaj (șină omega). Datorită amplasării elementului de încălzire PTC instalarea se face întotdeauna în poziție verticală! În cazul dulapurilor mari se recomandă montarea mai multor unități de încălzire în scopul distribuției uniforme a căldurii.

RELEVANT STANDARD
EN 61439

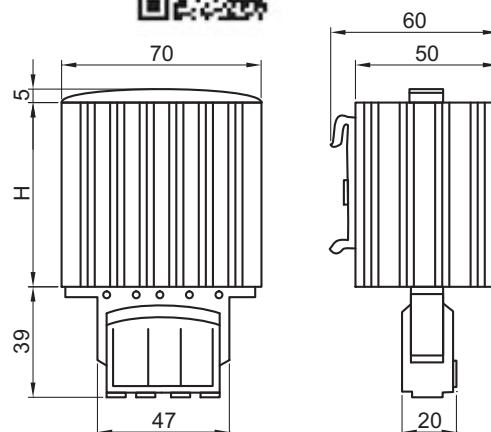

Unități compacte de încălzire cu ventilator montat

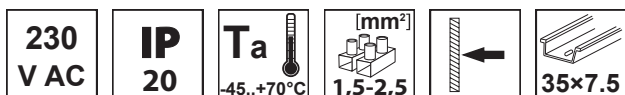

TRACON	P_{th} 	m^3/h 	T_h 	H (mm)	
FEV250	250 W	45 m^3/h	max. 75 °C	182	1.100 g
FEV400	400 W	45 m^3/h	max. 75 °C	222	1.400 g

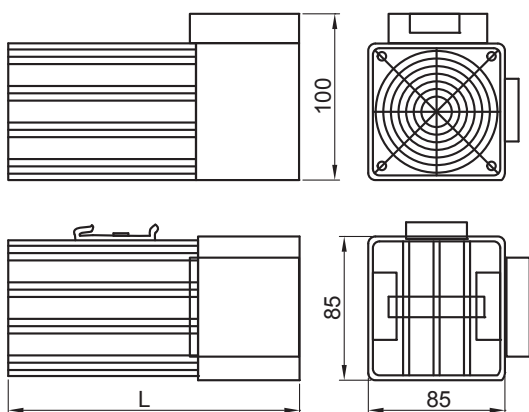

RELEVANT STANDARD
EN 61439



Varianta unităților de încălzire obișnuite cu ventilator montat oferă o încălzire mai eficientă și condiții de circulație mai bune, putem realiza o distribuție mai uniformă a căldurii. În mare funcția și construcția seamănă cu cele prezentate anterior. Dispozitivele sunt echipate cu protecție împotriva supraîncălzirii.

Termostate (Reglatoare de temperatură)

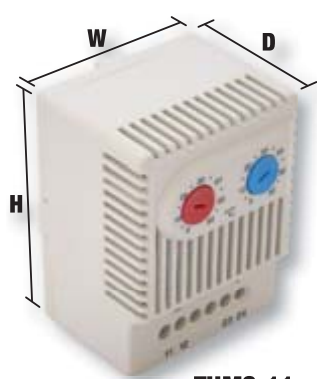

THMS-11



230 V AC	TRACON		VDC VAC A		H×W×D (mm)
IP 20	THMS-01		10 A	1 × NC	60×43×33
Ta	THMS-10	0-60 °C	250 V AC /	1 × NO	60×43×33
-20..+80°C	THMS-11		24 V DC	1 × NO	67×50×46
[mm ²] 1,5-2,5					
35×7.5					

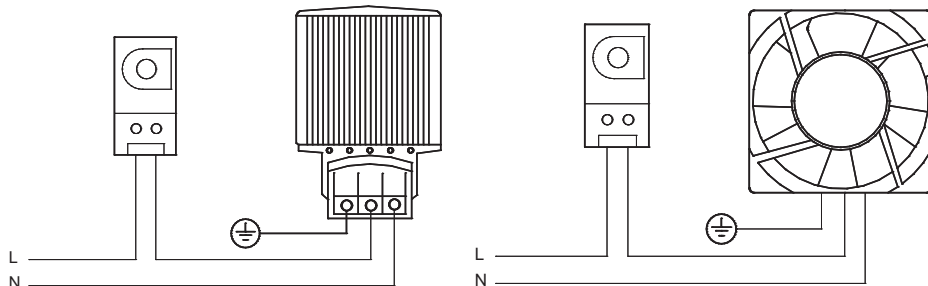

Higrostat



230 V AC	TRACON		VDC VAC A		H×W×D (mm)
IP 20	HGS-01	35-90	5 A 250 V AC	1 × CO	67×50×38

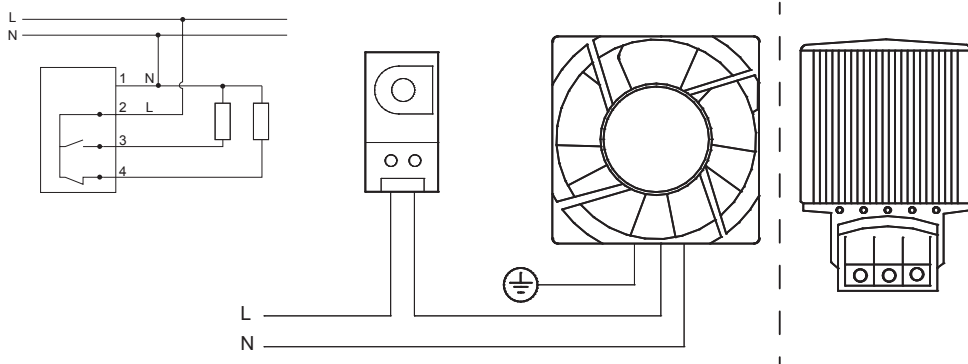

Clemă derivație din bara de distribuție

230/400 V AC Cu

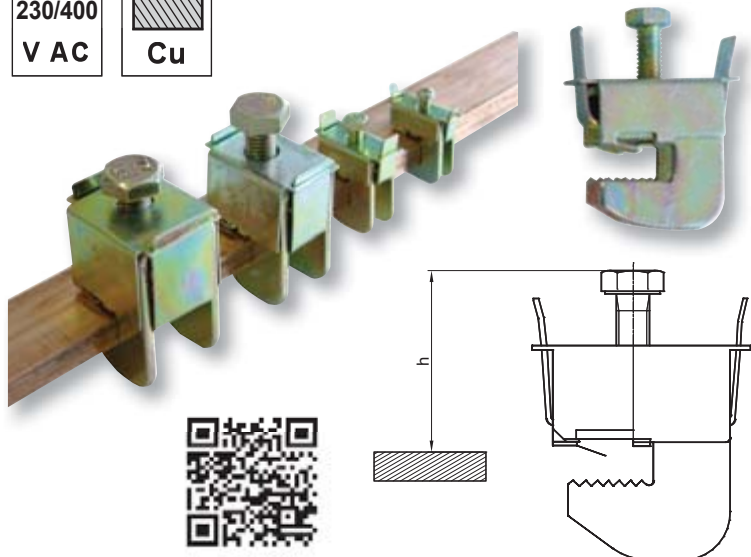

Legendă pictograme H/O

TRACON	mm ²	d	h_{min} (mm)	h_{max} (mm)
GLK1-0104	1-4	4-5 mm	17	23
GLK1-2516	2.5-16	4-5 mm	22	29
GLK1-1650	16-50	4-5 mm	26	39
GLK1-3570	35-70	4-5 mm	39	57
GLK2-0104	1-4	9-10 mm	17	23
GLK2-2516	2.5-16	9-10 mm	22	29
GLK2-1650	16-50	9-10 mm	26	39
GLK2-3570	35-70	9-10 mm	39	57
GLK2-70185	70-185	9-10 mm	44	66

Cleme reglabile de fixare a cablurilor

TRACON		B (mm)	H (mm)
AKR1-0612	6-12 mm	31	70
AKR1-1218	12-18 mm	24	70
AKR1-1822	18-22 mm	28	70
AKR1-2230	22-30 mm	39	85
AKR1-3038	30-38 mm	45	90
AKR1-3842	38-42 mm	47	95
AKR1-4250	42-50 mm	57	120
AKR1-5064	50-64 mm	70	130

Adesea apare necesitatea fixării cablurilor de legătură care intră în tabloul de distribuție. Pentru acesta recomandăm clemele de fixare a cablurilor. Cleva în formă de cârlig trebuie agățată în șina de susținere montată anterior, apoi se strânge împreună cu cablul.

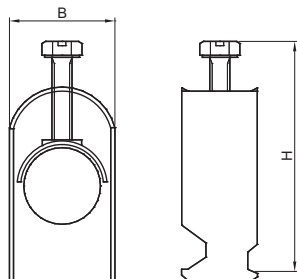



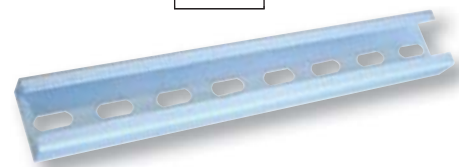
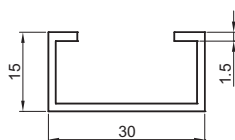

Șină de susținere pentru cleme reglabile de fixare a cablurilor

TRACON		1 m
30/15SIN		



Distanțiere

TRACON	H (mm)	M (mm)	D (mm)	B (mm)	A (mm)	 (N)	 (N)		
STS-25	25	6	24	26,5	9	3000	2000	3	28 g
STS-30-6	30	6	27	32,4	10	4600	3500	3	44 g
STS-30	30	8	27	32,4	10	4600	3500	6	44 g
STS-30-10	30	10	27	32,4	10	4600	3500	10	44 g
STS-35-6	35	6	28	31,9	8	5500	4300	3	50 g
STS-35	35	8	28	31,9	8	5500	4300	6	50 g
STS-35-10	35	10	28	31,9	8	5500	4300	10	50 g
STS-40-6	40	6	34	40,1	10	6200	5000	3	86 g
STS-40	40	8	34	40,1	10	6200	5000	6	86 g
STS-40-10	40	10	34	40,1	10	6200	5000	10	86 g
STS-51	51	8	29	35,3	13	6400	5250	6	83 g
STS-51-10	51	10	29	35,3	13	6400	5250	10	83 g
STS-51-12	51	12	29	35,3	13	6400	5250	14	83 g
STS-76	76	10	35	49,8	16	7000	5900	10	233 g

1.000 V AC	1.500 V DC	Utest 1min 5 kV
---------------	---------------	-----------------------

VO UL94	Ta -40..+130 °C
------------	--------------------



Distanțiere din material plastic servesc instalării diverselor prize de siguranță, șinelor colectoare, panourilor de distribuție și comandă, altor instalații electrice folosite în spații închise, până la limita admisă a tensiunii. În comparație cu izolatoarii tradiționali ceramici, oferă economie de spațiu și greutate. Materialul constă dintr-un amestec de făină de cuarț și rășină epoxidică fără conținut în halogeni, în proporție optimă. Inserțiile cu filet interior necesare fixării suporturilor se incorporează în masa plastică în faza de turnare. Suporturile izolatoare prezintă proprietăți mecanice, termice și electrice avantajoase, se instalează rapid și cu siguranță. Tensiunea de străpungere poate fi mărită prin mai multe suporturi suprapuse.

