

TECHNICAL SPECIFICATION

FOUR CHANNEL CONSTANT VOLTAGE WIFI RECEIVER



- WiFi-CV4 is four channel constant voltage controller, can control RGB/RGBW, color temperature or dimming LED lamp.
- If you need control more lamps, add constant voltage or constant current power repeater.
- Through jump, strobe, gradual change style, fine adjust color, realize thousands of powerful editing effect.
- Can store up to 32 changing mode.
- Can run large cycle mode, or run small loop mode.
- Changing mode or loop mode can be stored to 8 scenes, or timing run.

Technical data:

Input voltage:	5-24 VDC
Output current:	4CH, 3A/CH
Output power:	60-288W
Dimming range:	0-100%
Remote distance:	30m
Working temperature:	-30°C~55°C
Product size:	Φ72×25mm
Net weight:	73 g
Catalogue number:	99RGBWF4

Dimensions:

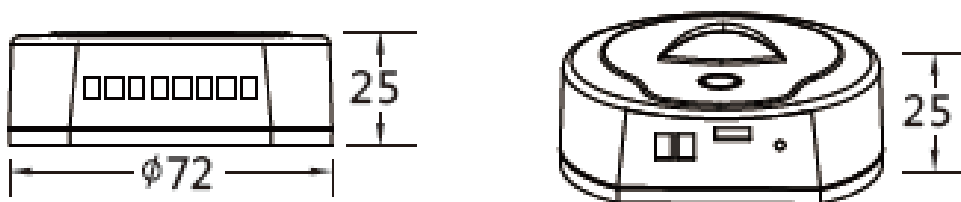

Wiring diagram:

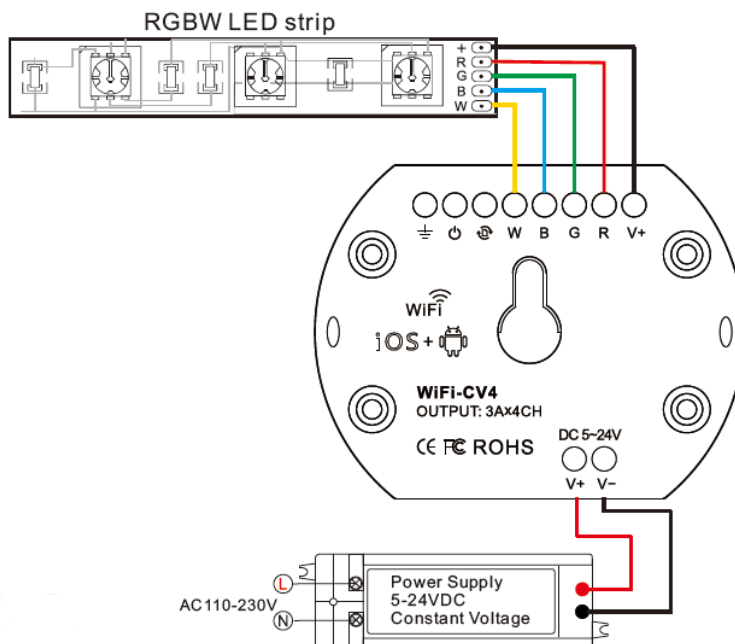

Application:

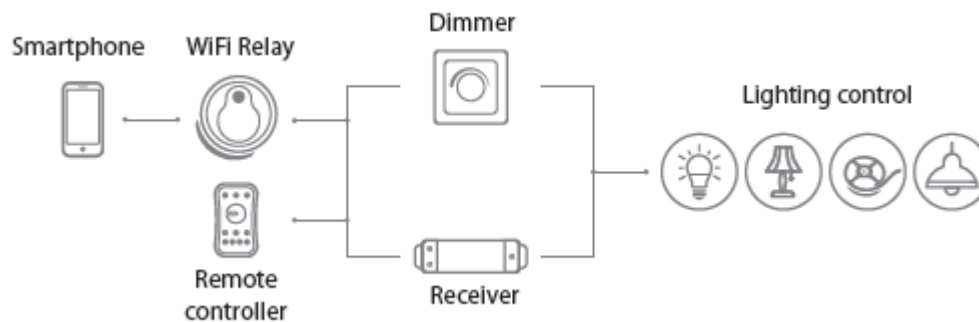

Software: Skydance

WiFi controller connection:

1. Direct connect Wi-Fi controller

1. Enter mobile device's Wi-Fi setting, search and connect Wi-Fi controller, such as WiFi-CV4-36.
2. Start Skydance application, enter device list interface, start control light.
3. If you need change Wi-Fi ID or password. Click to enter network interface for setting.

If you forget password, long press reset/match key for 10 seconds, indicator turn red, restore factory settings.

2. Connect Wi-Fi controller to your home network

1. Repeat above 1, 2 step, click to enter network interface, Click search key to search the workable Wi-Fi ID list, such as Jlighting, enter its password, add the Wi-Fi controller to the home network.
2. Exit application, enter mobile device's Wi-Fi setting, connect home network, such as Jlighting.

When the connection is successful, that mobile device in the normal Internet can control the lights at the same time.

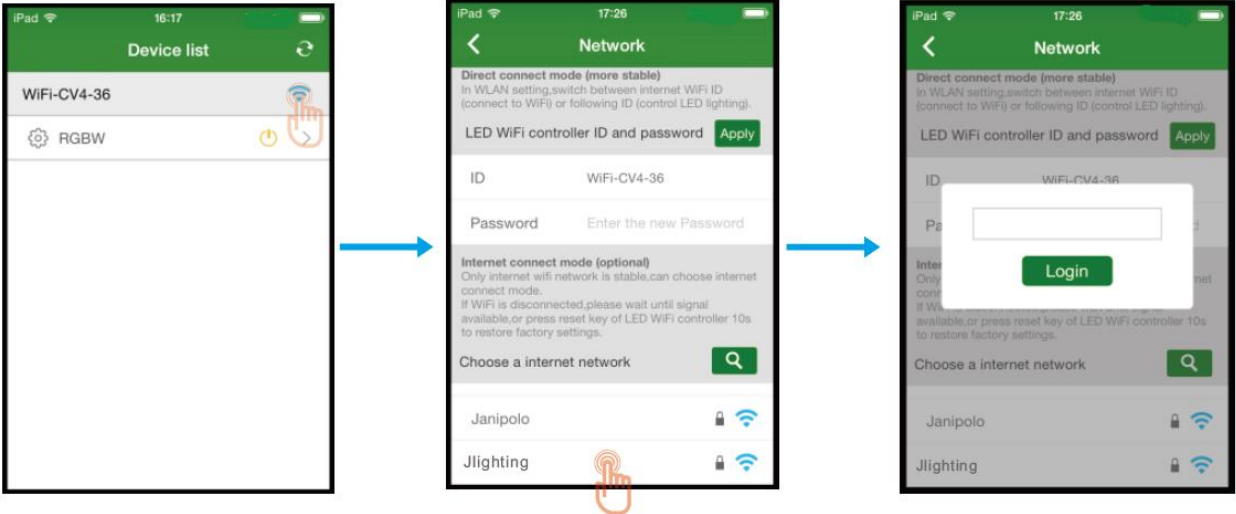

Controller match method:

- Wi-Fi -CV4 controller is default as RGBW controller, if the lamp is RGBW type, no need this step.
- When light type is RGB, CCT (WW+NW or WW+NW+CW), or dimming type, must be set as follows:

Enter Device list interface, Click Setting, enter Match and setting interface, click > key of Type line, select light type, such as RGB, short press Reset/Match key of Wi-Fi controller, click Match key of the APP immediately.

- The WiFi-CV4 controller is set to RGB controller.

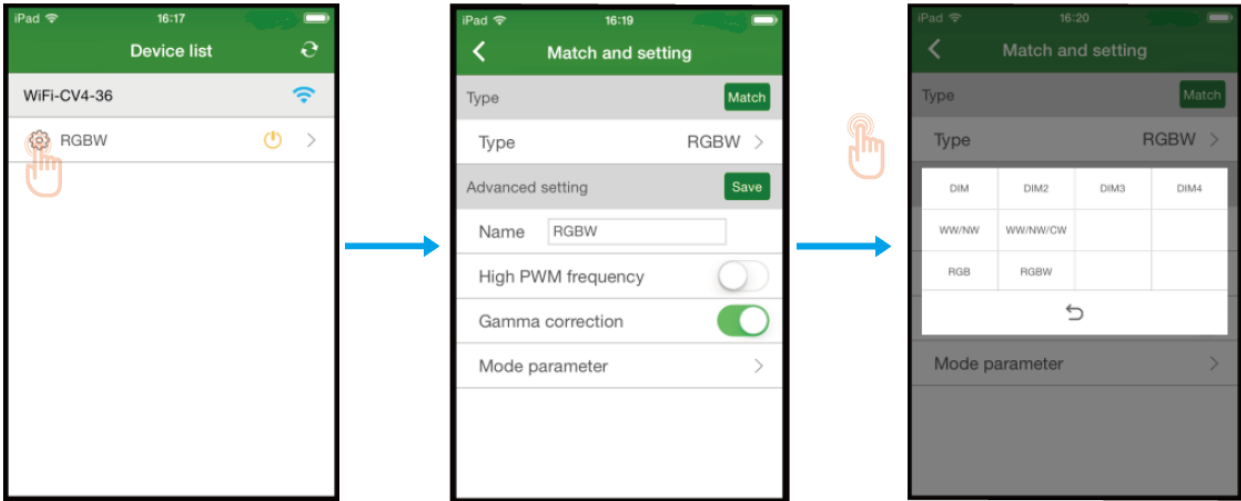

- Wi-Fi controller also can match RGB/RGBW, color temperature or dimming remoter.
- Short press Reset/Match key, then press any key of the remoter (multi-zone remoter use zone key) immediately, indicator flash blue rapidly, match is successful.
- Long press Reset/Match key for 5s will delete match.

Enter light interface

In Device list interface, Click the middle of lamp name line or > key, enter corresponding Static color or Mode interface, change color, mode or scene. Click, turn on/off light.

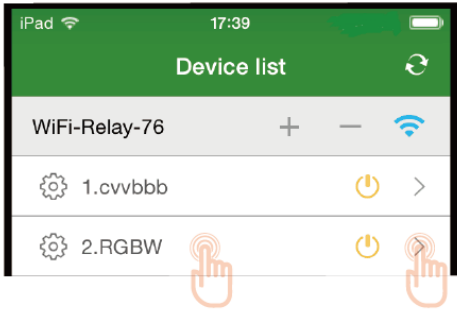

Static color interface

Touch color plane or direct input brightness value to change light color or brightness.

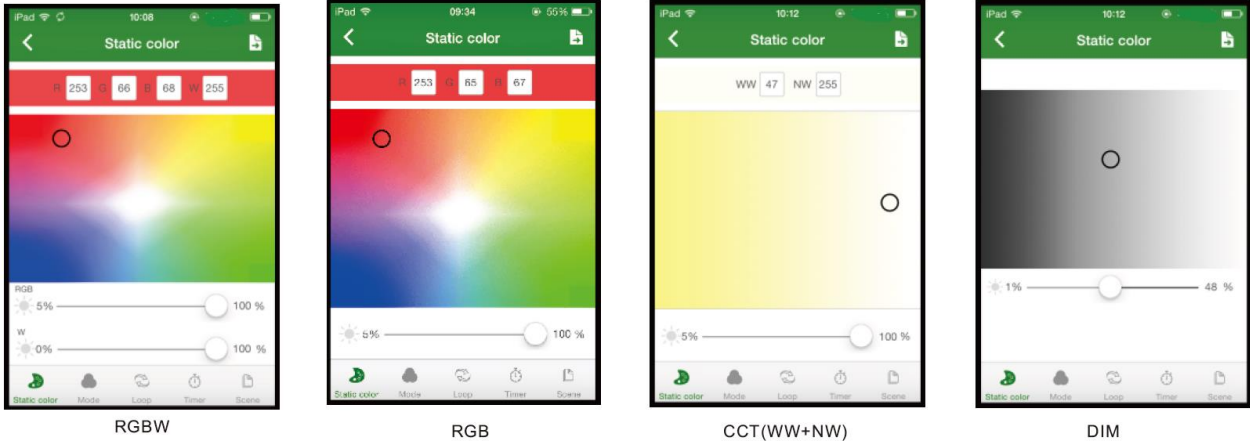

Mode interface

- Click Edit key to edit changing mode list.
- Click + or - key to increase or decrease mode number (1-32),
- Click Color column to alter color selection,
- Click Style column to alter style selection,
- Click Runtimes column to edit runtimes (0-200) of each mode.
- After modification, click Save key to load new changing mode list to the controller.
- Click top-right key, you can export changing mode list as backup files, automatically deposited in the mobile device, or import backup files to changing mode list. When the mobile device connects other Wi-Fi Relay controller, you can use the backup file to synchronous modify changing mode rapidly.

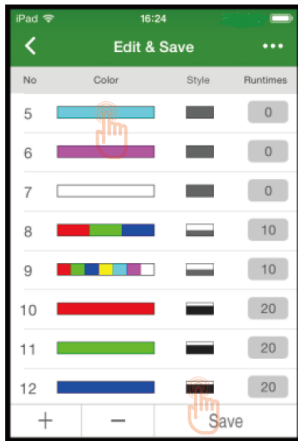
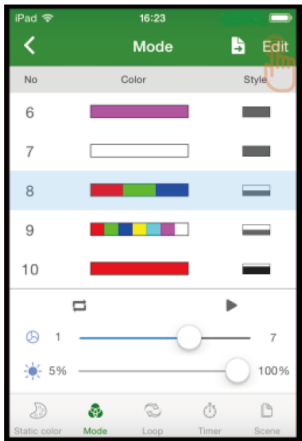

Select mode color

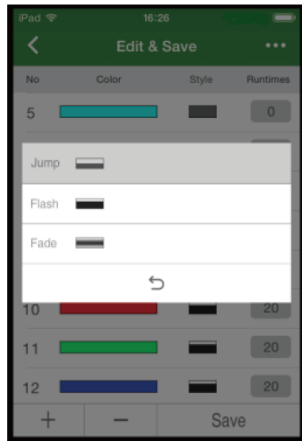

Select mode style

Loop interface:

- There are four loop mode, each loop mode can edit 2~8 changing mode, such as modify color or style, speed, and runtimes.
- Click key start loop mode.
- Loop mode can be stored as scene or timing run.



Timer interface

According to the time of the mobile device regularly play function, run different effects in different time period.
Up to 10 time period, each time period set start time and end time, run changing mode, loop mode or scene.
Click key start timing run, the indicator turn green.

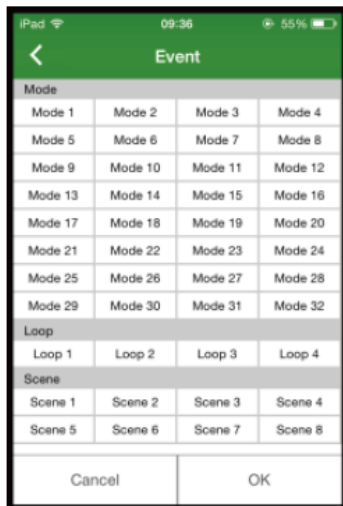
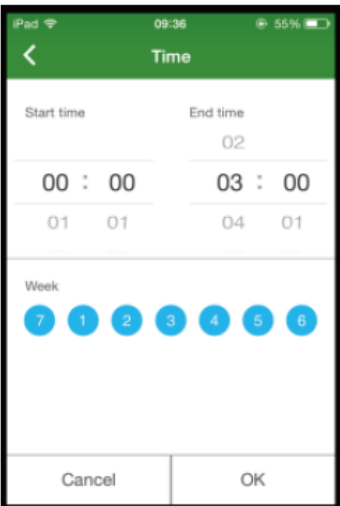

7 Set start time and end time

Select changing mode,

Scene interface

There are 8 stored scene, each scene can edit name or replace picture. Save the scene, or change the existing scene, you need enter Static color or Mode interface firstly, select color or changing mode, click top-right key, save to any one scene number.

