

TECHNICAL SPECIFICATION

FOUR CHANNEL CONSTANT VOLTAGE LED DIMMING RECEIVER



- 5A 4CH PWM constant voltage controller.
- Default as RGBW controller, need match RGBW remoter, create colorful static or dynamic effect.
- Can also be used as RGB, color temperature or dimming controller, good compatibility.
- Full compatibility with a variety of single color, dual color and RGB/RGBW remote.
- PWM achieve 4096 levels flicker-less dimming.
- When control RGB/RGBW lamp, built in 30 change mode optional.
- Adopt 2.4GHz wireless technology, can accept up to 10 remote control.
- Can be Wi-Fi controlled by APP installed on IOS or Android mobile devices while working with Wi-Fi-Relay controller.
- Can connect with external switches to achieve on/off and scene change function.
- Work with power repeater to expand output unlimitedly.

Technical data:

Input voltage:	12-36VDC
Output voltage:	PWM constant voltage
Output current:	4CH, 5A/CH
Output power:	4 x (60-180) W
Grey levels:	4096/CH
Dimming range:	0-100%
Remote distance:	30m
Working temperature:	-30°C~55°C
Product size:	L175×W45×H27mm
Net weight:	110 g
Catalogue number:	99RECEIVER4

Dimensions:

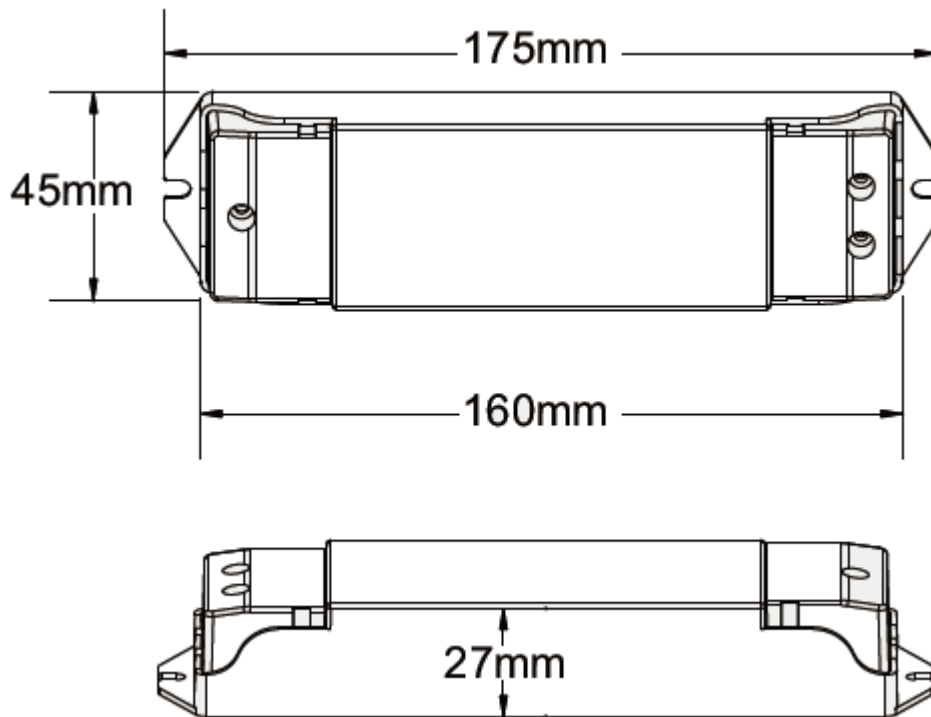

Interface Specification

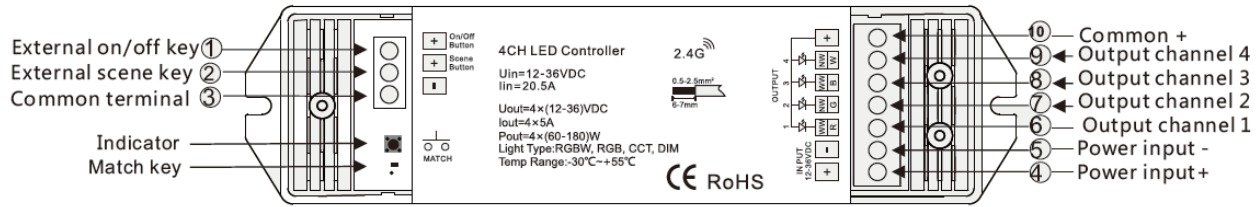

Used as a RGB/RGBW controller, the output connection: ⑩ positive, ⑥ red light, ⑦ green light, ⑧ blue light, ⑨ white light.

Used as a color temperature controller, the output connection: ⑩ positive, ⑥/⑧ warm white light, ⑦/⑨ natural white light.

Used as a dimming controller, the output connection: ⑩ positive, ⑥/⑦/⑧/⑨ lamp cathode, synchronous or individual dimming.

Match key function

Short press: Within 5s, press any key of the remoter for match.

Multi-zone remoter must press zone key.

Long press (5s): Delete all matched remoter, lights remain in the current state.

Long press (10s): Restore factory default parameters.

External switch key function

1. On /Off key

Short press: Turn on/off light.

Long press (1-5s): When light is on, adjust brightness.

Long press (10s): When multiple controllers share a on/off key, achieve simultaneous adjustment

2. Scene key

● **Short press:** Select 8 scenes.

● **Long press (10s):** When multiple controllers share a scene key, achieve simultaneous select.

➤ How to connect **FOUR CHANEL CONSTANT VOLTAGE LED DIMMING RECEIVER** with **Wi-Fi** devices

The **FOUR CHANEL CONSTANT VOLTAGE LED DIMMING RECEIVER** can work by installed iOS or Android application, via a Wi-Fi relay controller.

How to:

1. Turn on Wi-Fi relay controller.
2. Connecting the Wi-Fi controller to **your** network.

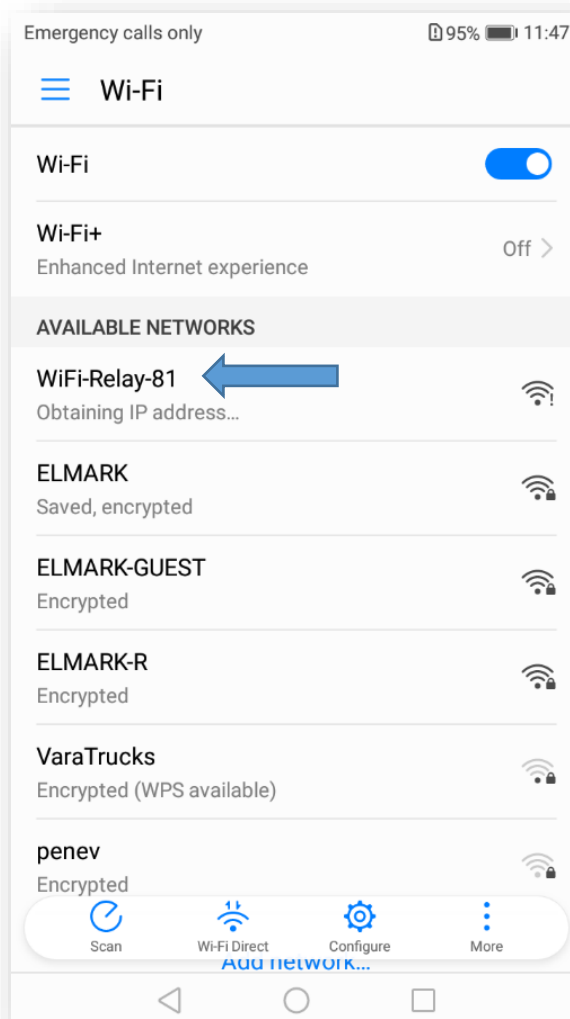
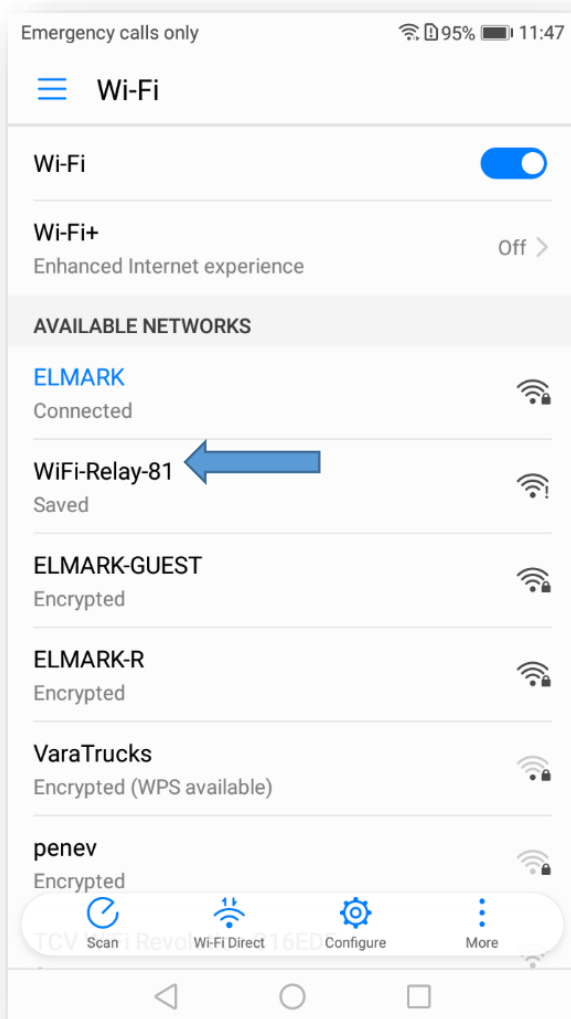

3. Start the “Skydance” app (should be already installed).

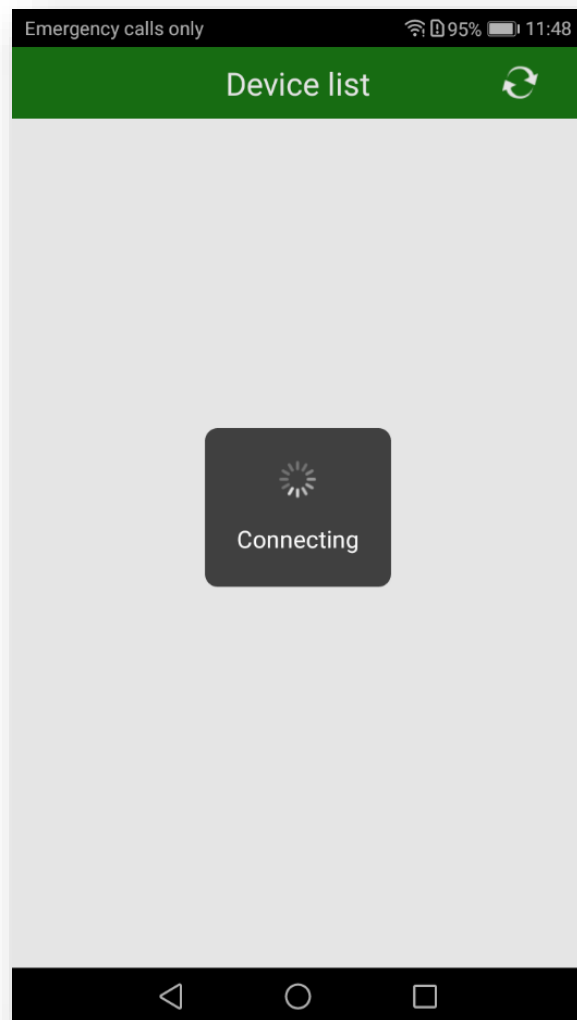

4. Connecting the Wi-Fi relay controller with the **FOUR CHANEL CONSTANT VOLTAGE LED DIMMING RECEIVER.**

4.1. Select the type of device we will command

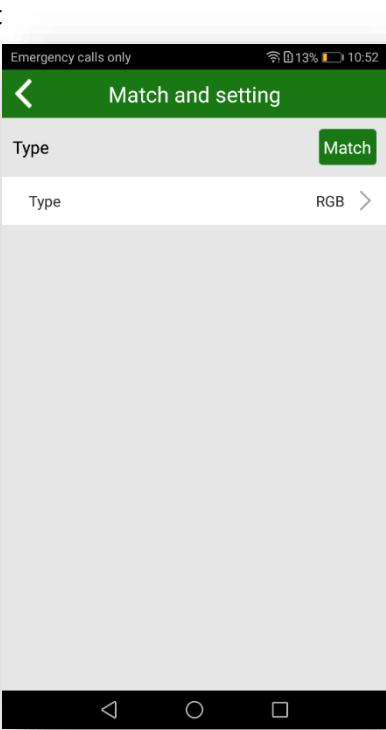
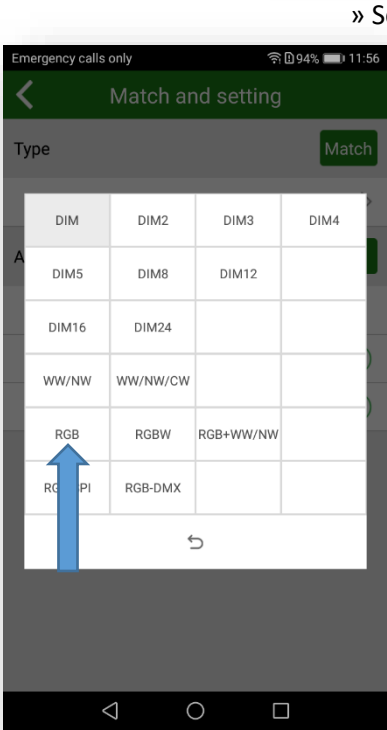
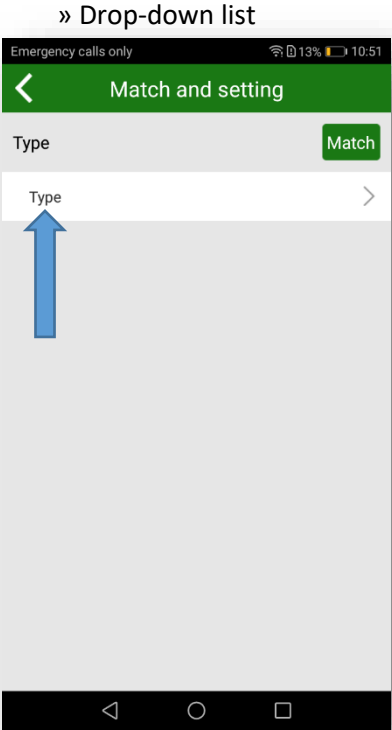
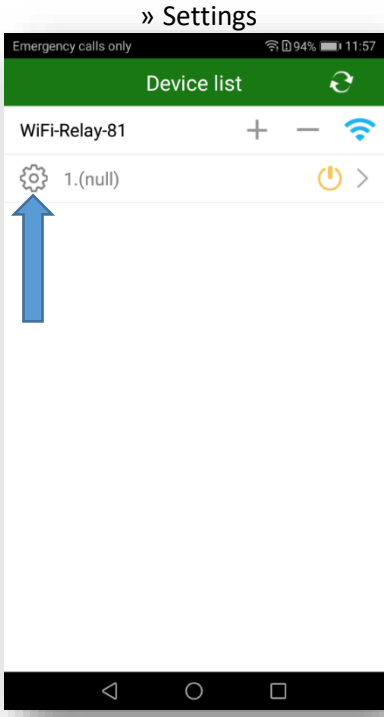
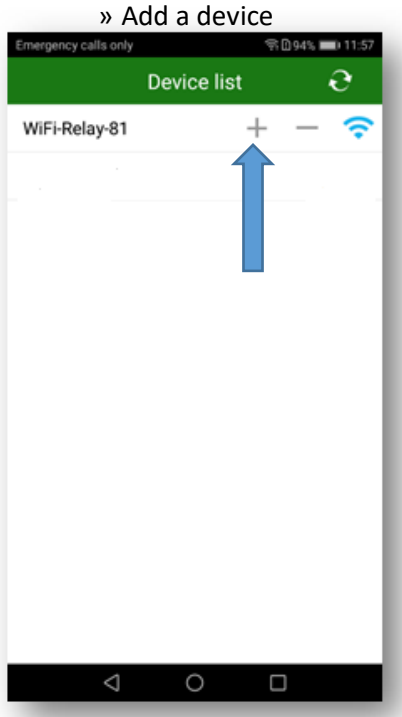

5. To connected press "Match" on **FOUR CHANEL RECEIVER** and press "Match" on your phone.
Press „Save” for finalizing the settings.

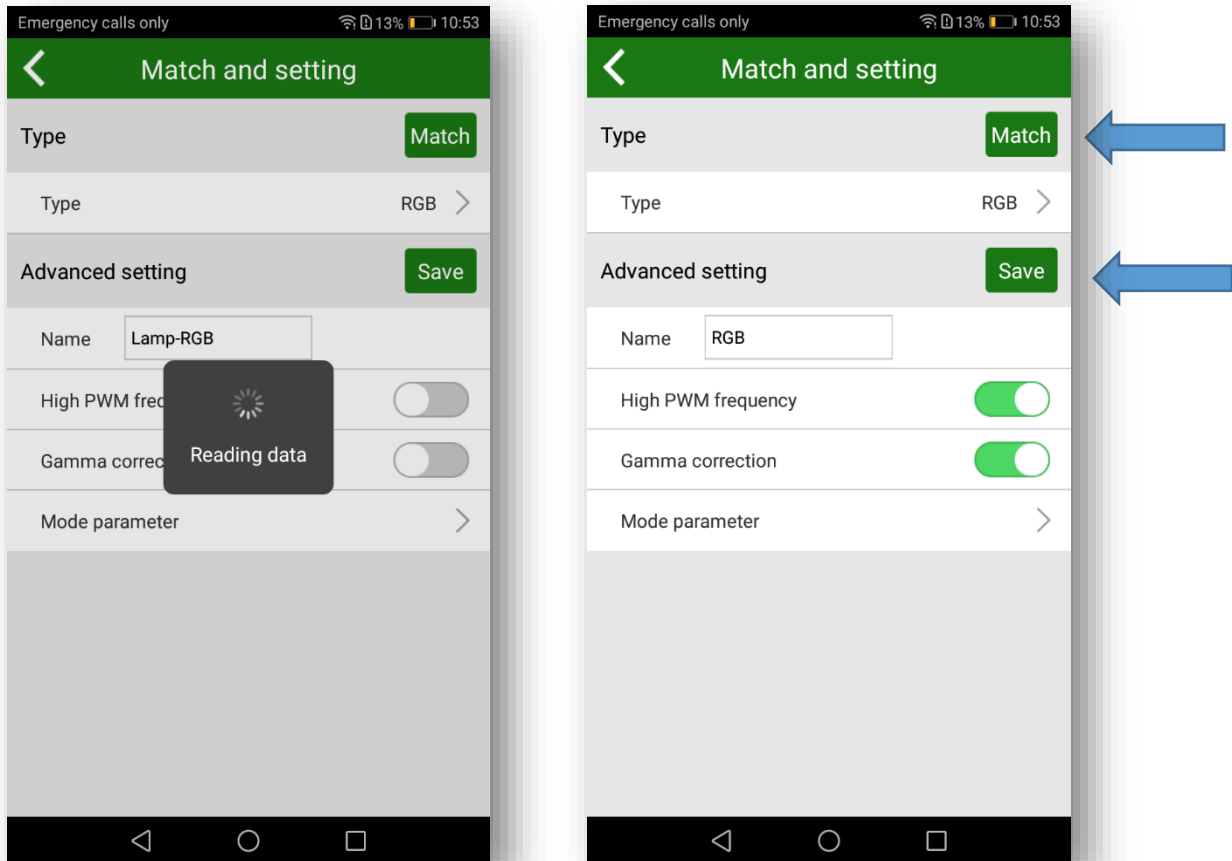

6. Your device is now connected.

FUNCTIONS:

» ON/OFF

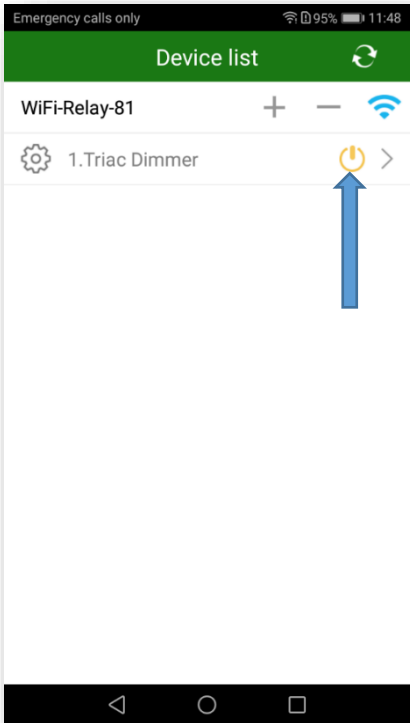

» Open the product menu

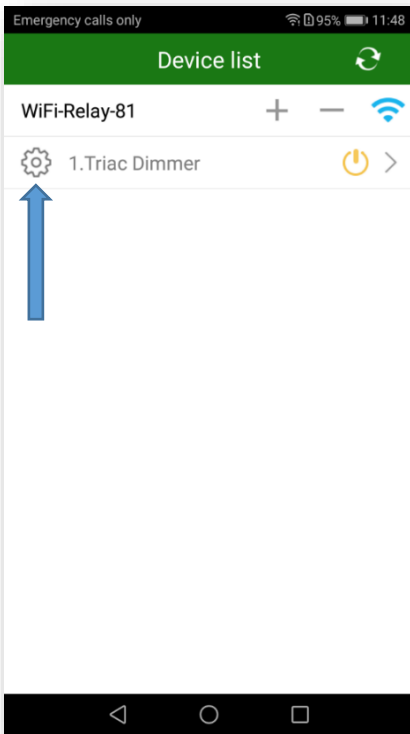

» Change light color or brightness

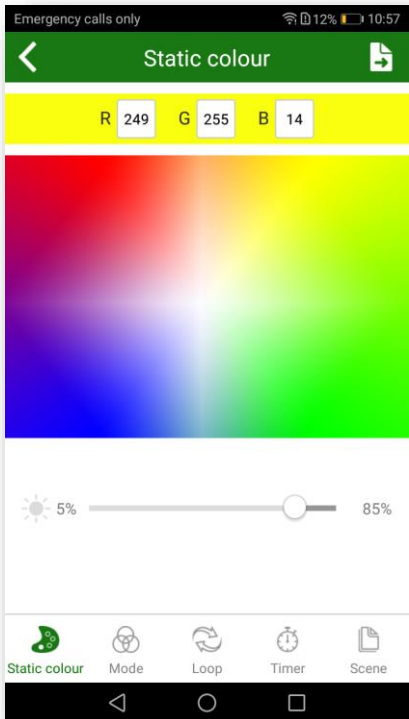

» Change mode color & style



» Select predefined scene

» Timer's settings

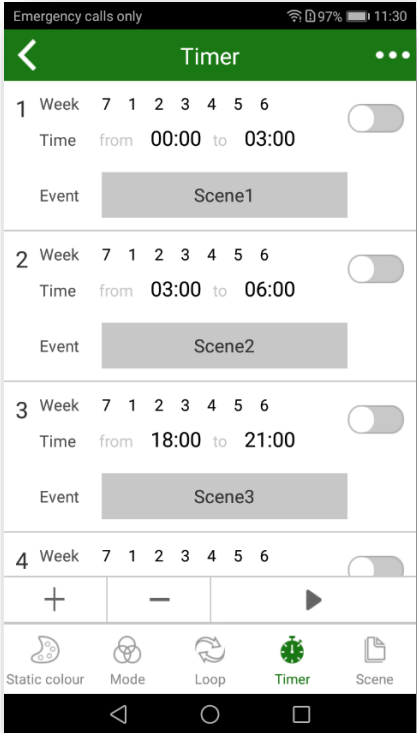

Wiring diagram

■ Dual Color

Dual Color

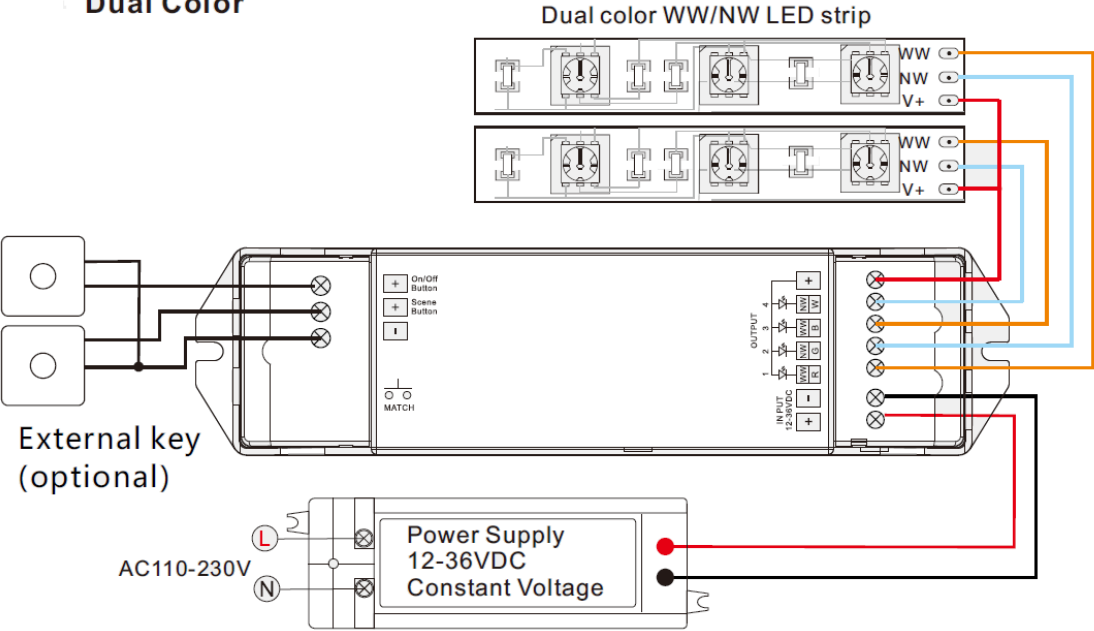

- Single Color

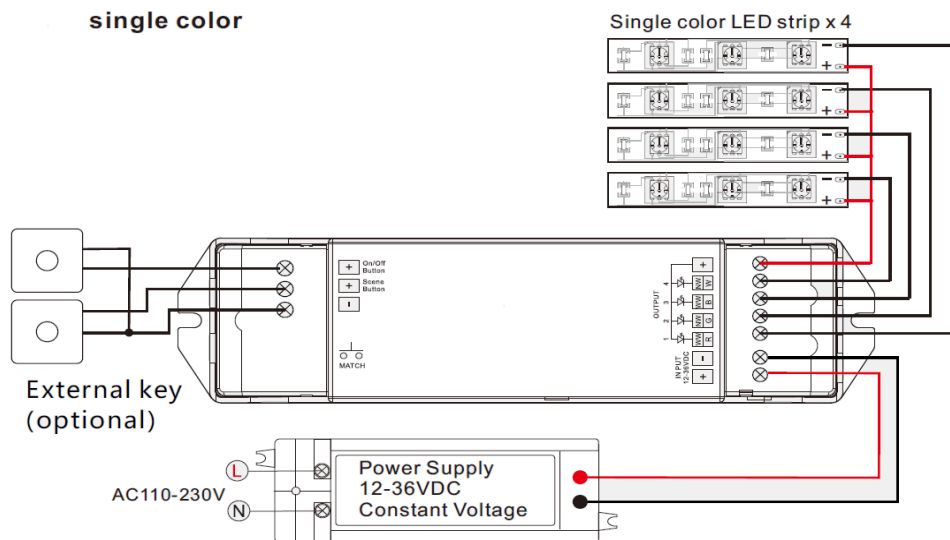

RGB Change mode list

No.	Name	No.	Name	No.	Name
1	Static red	11	Green strobe	21	Red yellow smooth
2	Static green	12	Blue strobe	22	Green cyan smooth
3	Static blue	13	White strobe	23	Blue purple smooth
4	Static yellow	14	RGB strobe	24	Blue white smooth
5	Static cyan	15	7 color strobe	25	RGB+W smooth