

Wiring

Having correctly identified the wiring from your existing light fitting, pull the wire through the hole and connect to the connection block inside the product in the following way:

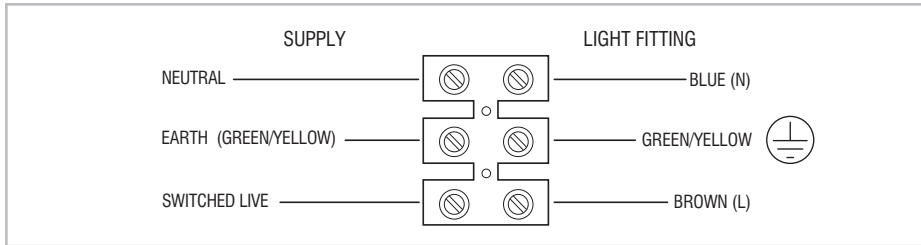

Check that...

- You have correctly identified the wires.
- The connections are tight.
- No loose strands have been left out of the terminals.

Care and Safety

- We recommend cleaning with a soft dry cloth. Do not use solvents or abrasive cleaners as these could damage the finish.
- Always disconnect the product from mains at least 10 minutes allowing to cool down before any maintenance or adjustment.

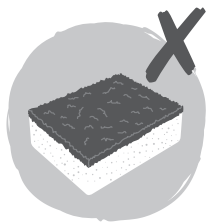

Instruction leaflet

Oxxo (IP20 tube ready) Batten

78548, 78549, 78550, 78551, 78552, 78553



saxby
lighting

Thank you for purchasing this light fitting. Please read the instructions carefully before use to ensure safe and satisfactory operation of this product. Please retain these instructions for future reference.

Warning

Please read these instructions carefully before commencing any work.

This unit must be fitted by a competent and qualified electrician.

Install in accordance with IEE Wiring regulations and current Building Regulations.

Check the pack and make sure you have all of the parts listed.

To prevent electrocution switch off at mains supply before installing or maintaining this fitting.

Ensure other persons cannot restore the electrical supply without your knowledge.

This light fitting should be connected to a circuit with a 30mA RCD fitted.

If replacing an existing fitting, make a careful note of the connections.





Cables must be protected using suitable conduit or plastic trunking.

Always use the correct type and wattage bulb.

These products should not be fitted to PIR circuits or short duration timed switches. Should you wish to connect this unit to a timed system please consult the manufacturer before installation.

The mains supply cable must have a minimum cross sectional area of 1.0mm².

Technical data

Supply Voltage:	240V~, 50 Hz	
Bulb Type:	1 x T8 18W LED 4FT - 78548 1 x T8 23W LED 5FT- 78549 1 x T8 30W LED 6FT- 78550	2 x T8 18W LED 4FT- 78551 2 x T8 23W LED 5FT- 78552 2 x T8 30W LED 6FT- 78553
	All light sources are not available. Need to buy separately. <i>This series of lamps must use LED tubes with single ended power supply.</i>	
	Conformity with all relevant EC Directive requirements.	
	Waste electrical products should not be disposed of with household waste. Please recycle where facilities exist. Check with your Local Authority or local store for recycling advice.	
	Class I product, must be connected to earth.	
	This product is not suitable for dimming.	
IP20		

Installation

Existing fittings must be completely removed before installation of a new product. Before removing the existing fitting, carefully note the position of each set of wires.

- Note that the power needs to be isolated/switched off at the fuse board.
- Plan the desired layout of these fittings carefully, ensuring the cables will reach the distances between the power supply and each light fitting.
- Avoid locating any cables in positions that would cause a hazard. Position cables and junction boxes (not supplied) away from areas where they may be at risk from being cut, trapped or damaged.
- Loosen the two screws holding the top plate in place. remove the top cover. (Single fitting is shown below)
- Hold the product in place and mark the position of the holes. This may require the help of an assistant. If wall mounting, ensure that the product is level.
- Lift the product into place and mark the position of the holes.
- Adjust the cable so it does not get snagged.
- Ensure the ceiling or wall is capable of holding the weight of the product. Take care to avoid damaging any concealed wiring and pipes. The correct fixings should be used for brick, cavity walls or plasterboard.
- Fix into position and replacing the top cover.
- Install the light source (make sure to use the correct type and wattage bulb).
- Switch on. Your light is now ready for use.

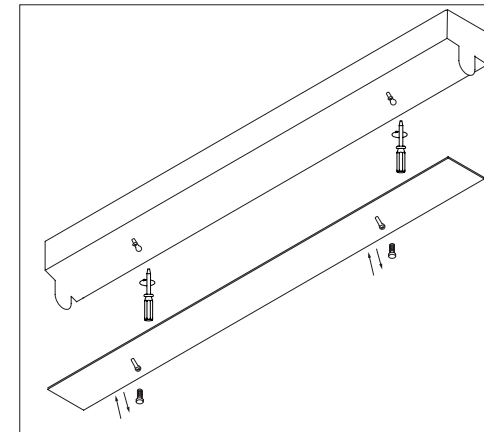

Fitting/replacing bulbs

- When changing a bulb, always switch off at the mains and allow the bulb to cool before handling.
- Used bulbs should not be disposed of with household waste. Please recycle where facilities exist.
- Always use the correct type and wattage bulb. Using the incorrect wattage bulb will damage the bulb.
- LED tube used must be single ended power supply. And in the other end of LED tube must with fuse or short circle connection.

