

Wiring

Having correctly identified the wiring from your existing light fitting, pull the wire through the hole and connect to the connection block inside the product in the following way:

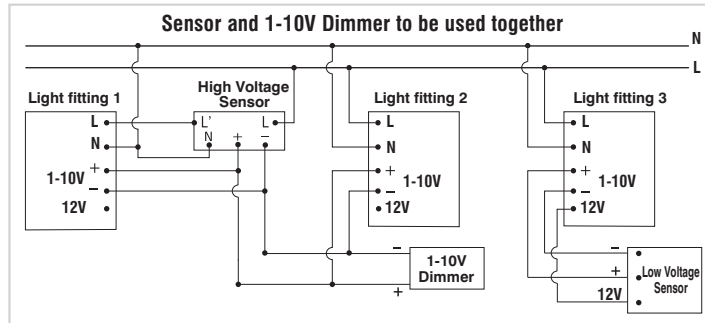
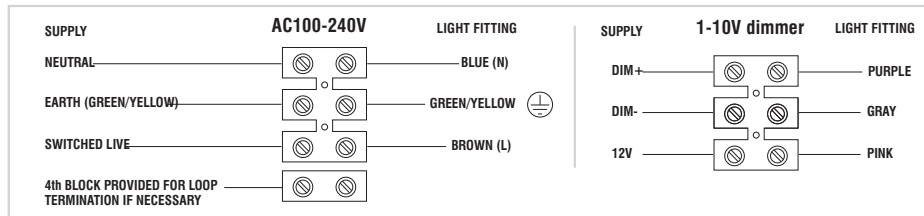

Check that...

You have correctly identified the wires.

The connections are tight.
No loose strands have been left out of the connection block.

When completed, ensure that there are no bare or loose strands of wire exposed, and cover all exposed areas of the connection block with 2 layers of insulation tape.

Technical data

Supply Voltage: 100-240 V~, 50 Hz

Bulb Type: 78573--100W LED, 6500K / 78574--150W LED, 6500K / 78575--200W LED, 6500K
This product contains a light source of energy efficiency class **E**.

 Non-replaceable light source |  Non-replaceable control gear

 Conformity with all relevant UKCA Directive requirements.

 Conformity with all relevant EC Directive requirements.

 This product is Class 1, must be connected to earth.

 Waste electrical products should not be disposed of with household waste. Please recycle where facilities exist. Check with your Local Authority or local store for recycling advice.

 This product is suitable only for dimming with 1-10V type dimmers.  This product is rated at IP65.

Care and Safety

We recommend cleaning with a soft dry cloth. Do not use solvents or abrasive cleaners as these could damage the finish. For your safety, always switch off the power supply before cleaning.

For further information, please visit <https://www.lighting-info.co.uk/78573>

V6 14/07/2022
UK Manufacturer: BH17 7BY
EU Manufacturer: Brilliant AG,
Brillantstrasse 1, D-27442 Gnarrenburg

saxby
lighting

Instruction manual

Altum

78573, 78574, 78575



www.saxbylighting.com

saxby
lighting

Thank you for purchasing this light fitting. Please read the instructions carefully before use to ensure safe and satisfactory operation of this product. Please retain these instructions for future reference.

Warning

This is a Class 1 product and must be earthed.

Please read these instructions carefully before commencing any work.

This unit must be fitted by a competent and qualified electrician.

Install in accordance with the IEE Wiring regulations and current Building Regulations.

Check the pack and make sure you have all the parts listed.

To prevent electrocution switch off at mains supply before installing or maintaining this fitting. Ensure other persons cannot restore the electrical supply without your knowledge. If you are in any doubt, please consult a qualified electrician.

This light fitting should be connected to a fused circuit.

If replacing an existing fitting, make a careful note of the connections.

This system contains non-replaceable parts and cannot be serviced. If damage occurs the part should be scrapped.

Waste electrical products should not be disposed of with household waste. Please recycle where facilities exist. Check with your local authority or retailer for recycling advice.

Layout

Plan the desired layout of these fittings carefully, ensuring the cables will reach the distances between each light fitting.

Avoid locating any cables in positions that would cause a hazard. Position cables and junction boxes (not supplied) away from areas where they may be at risk from being cut, trapped or damaged.

Take care not to drill into any pipes or mains cables beneath the surface during mounting holes preparation.

The mains supply cable must have a minimum cross section area of 1.0mm².

Cables must be protected using suitable conduit or plastic trunking.

Luminaires are only suitable for mounting on non-combustible surfaces.

Never put anything on the product or hang anything on any part of this product.

Accessories

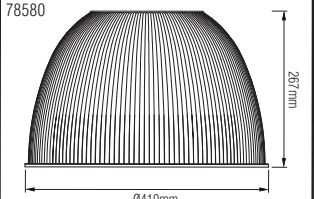
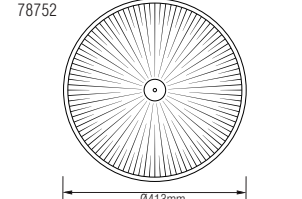
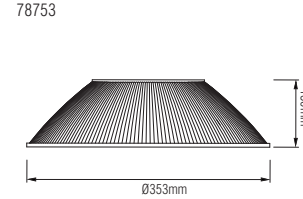
70° PC Reflector size	PC shade cover	90° Aluminium shade
78580 	78752 	78753 

Installation

Existing fittings must be completely removed before installation of a new product. Before removing the existing fitting, carefully note the position of each set of wires.

- Note that the power needs to be isolated/switched off at the fuse board.
- The fixing point(s) selected must be capable of supporting the full weight of the light fitting.
- Installation method 1. (Use a hook)
- Installation method 2. (Use a bracket)
- Shade installation.

Special reminder:

This lamp can be used with sensor (model no: 78577 and 78774).

For details on sensor installation, please see "Microwave motion sensor user's manual"

The Sensor and 1-10V dimmer can be used together.

When the light is 100% on, customer can use 1-10V dimmer to dim the light.

When the light is dim, customer can't use 1-10V dimmer to dim the light.

Details wiring please refer to wiring diagram

Installation method 1.

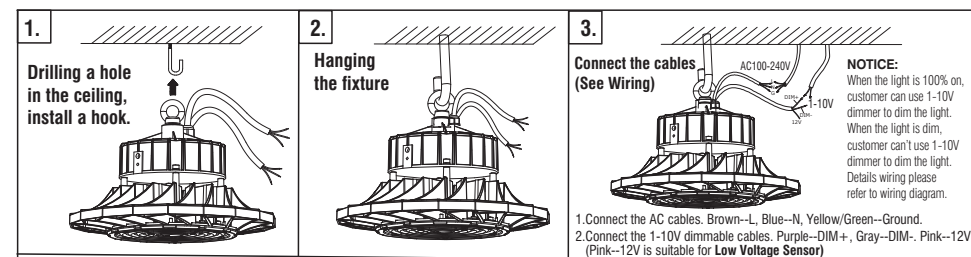

Installation method 2.

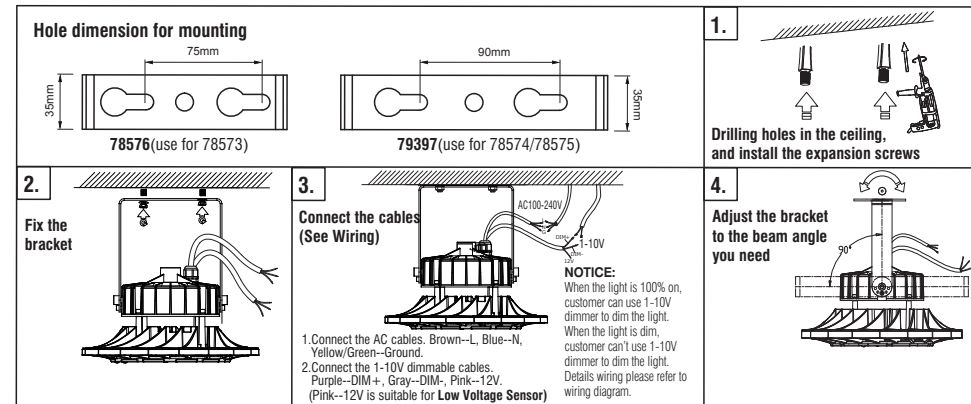

Shade installation.

