

Fitting Units

Locate the product in the track with the connections in the slot.

Slide the tab down, and rotate the product 90° to engage the connections in the track.

Allow the tab to slide back up and ensure that it is located correctly in the track slot.

Replace fuse or circuit breaker and switch on. Your light is now ready for use.

Technical data

Supply Voltage: 220-240 V~, 50 Hz

Bulb Type: 78959 / 78960 / 78961 --10W LED module (SMD), 4000K

94061/ 94062 / 94063 --10W LED module (SMD), 3000K

This product contains a light source of energy efficiency class **E**.



Non-replaceable light source

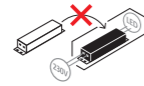

Non-replaceable control gear



Conformity with all relevant UKCA Directive requirements.



Conformity with all relevant EC Directive requirements.



This product is Class 1, must be connected to earth.



Waste electrical products should not be disposed of with household waste. Please recycle where facilities exist. Check with your Local Authority or local store for recycling advice.



This product is suitable for dimming.



Minimum distance from lighted objects (0.5 metres)

Care and Safety

- We recommend cleaning with a soft dry cloth. Do not use solvents or abrasive cleaners as these could damage the finish.
- Always disconnect the product from mains at least 10 minutes allowing to cool down before any maintenance or adjustment.
- For your safety, always switch off the power supply before cleaning.

For further information, please visit <https://www.lighting-info.co.uk/78959>

V4 06/06/2022

UK Manufacturer: BH17 7BY

EU Manufacturer: Brilliant AG,
Brilliantstrasse 1, D-27442 Gnarrenburg

saxby
lighting

Instruction manual

Pacto Track

78959, 78960, 78961, 94061, 94062, 94063



www.saxbylighting.com

saxby
lighting

Thank you for purchasing this light fitting. Please read the instruction carefully before use to ensure safe and satisfactory operation of this product. Please retain these instruction for future reference.

Warning

This is a Class 1 product and must be earthed.

Please read these instructions carefully before commencing any work.

This unit must be fitted by a competent and qualified electrician.

Check the pack and make sure you have all the parts listed.

Install in accordance with the IEE Wiring regulations and current Building Regulations.

To prevent electrocution switch off at mains supply before installing or maintaining this fitting. Ensure other persons cannot restore the electrical supply without your knowledge. If you are in any doubt, please consult a qualified electrician.

This light fitting should be connected to a fused circuit

If replacing an existing fitting, make a careful note of the connections.

This product is suitable for indoor use only, on normal flammable surfaces.

Only to be installed outside arms reach.

The light source of this luminaire is not replaceable; when the light source reaches its end of life the whole luminaire shall be replaced.

This track is suitable for dimming. Fittings with low voltage lamps are not suitable for dimming. Care must be taken to only use the same type of fitting that is able to be dimmed, and that the dimmer wattage must not be exceeded.

Waste electrical products should not be disposed of with household waste. Please recycle where facilities exist. Check with your local authority or retailer for recycling advice.

Layout

This track system can be extended to a variety of different configurations using accessories such as left bends, right bends, T junctions, X junctions and flexible joints.

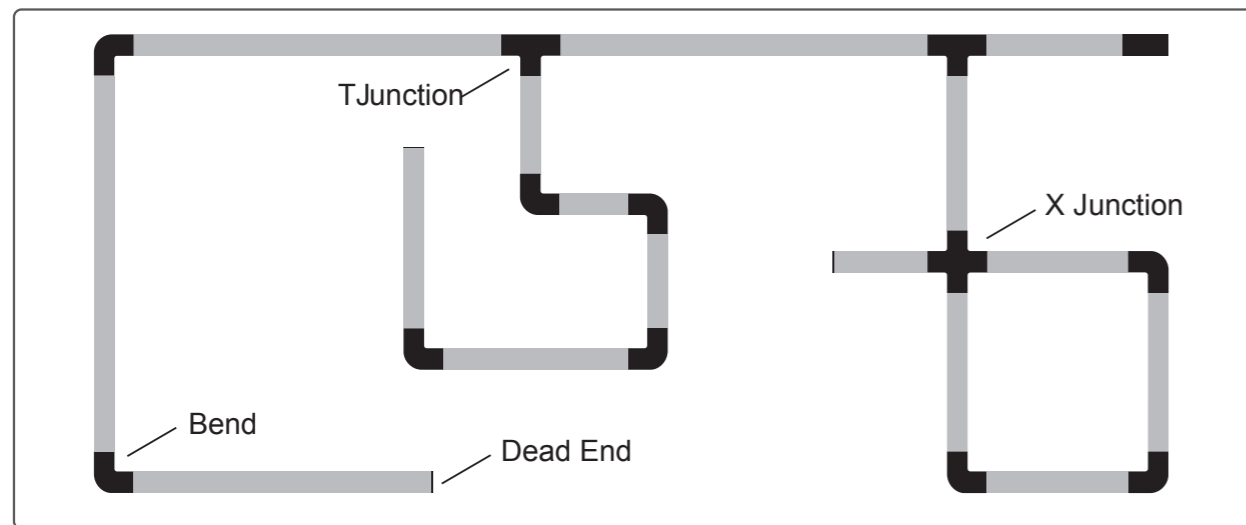

Track Accessory:

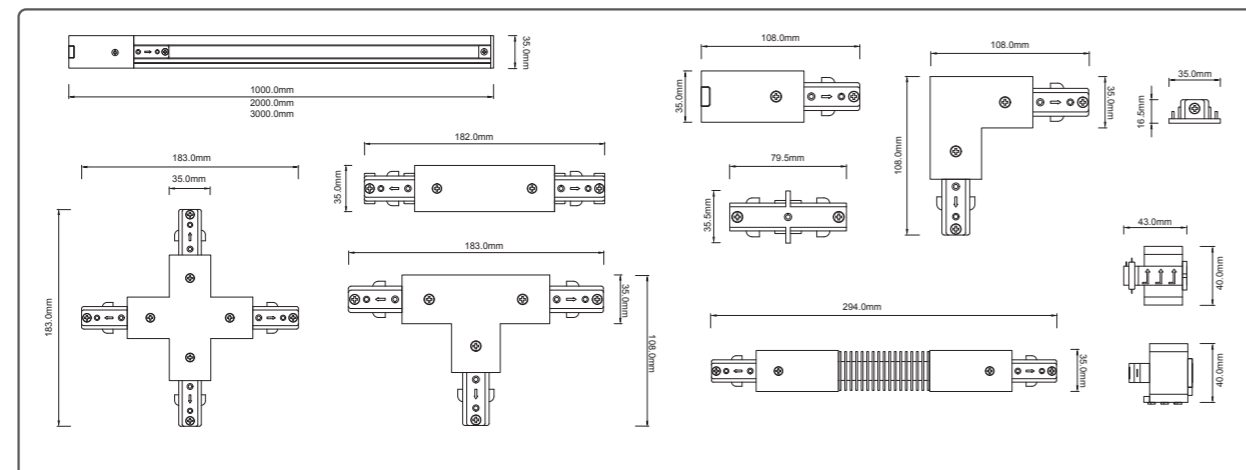

Products:

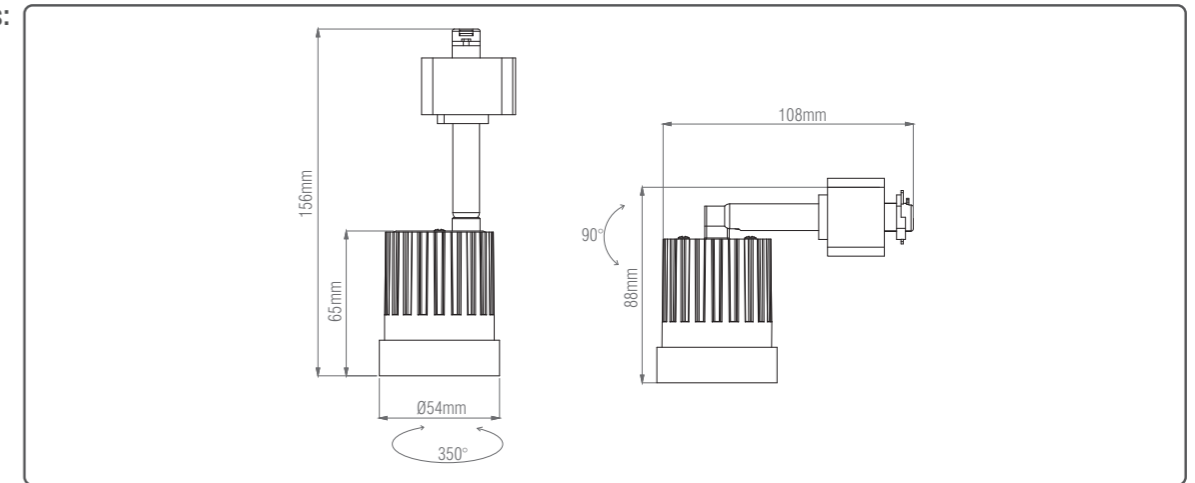

Installation

Existing fittings must be completely removed before installation of a new product. Before removing the existing fitting, carefully note the position of each set of wires.

Note the power at the fuse board and the luminaire must be switched off before installation or maintenance.

- Plan the track layout and decide accessories needed before fixing anything to the ceiling.
- The maximum power per run of track is 1KW (1000W).
- Ensure the ceiling is capable of holding the weight of the track and products. Take care to avoid damaging any concealed wiring and pipes. The correct fixings should be used for brick, cavity walls or plasterboard.
- Mark the first hole position and fit the screw in position as shown.
- Feed the screw through the keyhole slot, and slide into position. Mark the position of the second hole.
- Locate the track and fit the second screw into position.
- If fitting accessories, remove the end cap, and push them firmly home. Fit extra lengths of track as required.

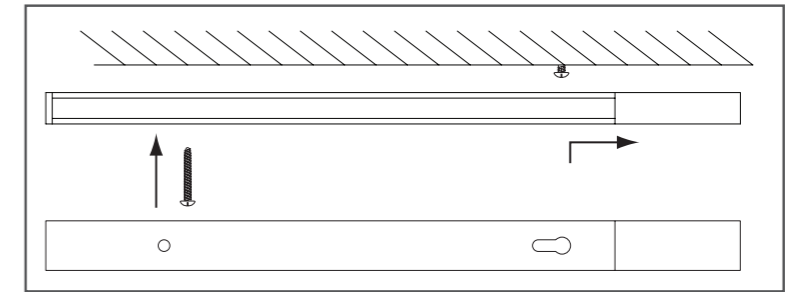

Connection

- The track accessories are provided with earth connection points on both sides.
- When offering the accessory to the track, verify which tab needs to be removed. (See left hand diagram).
- To remove the tab, grasp firmly with a pair of pliers and lever back.
- The tab should snap cleanly off. (See right hand diagram).
- Locate the accessory in the track and push home.

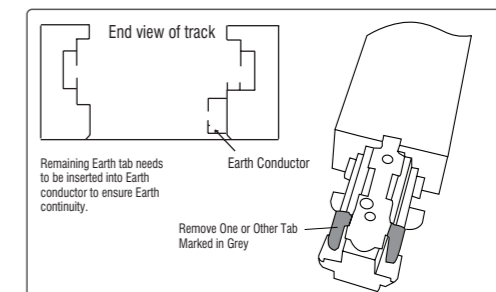

Wiring

Undo the screw and remove the cover from the live end. Push out the desired cable access point. Identify the correct cable from the supply and pull through.

Connect the supply wires to the terminal block, opposite the corresponding wires from the fitting. The central connector can also be wired in this way.

Refit the cover onto the live end taking care not to trap the cable.

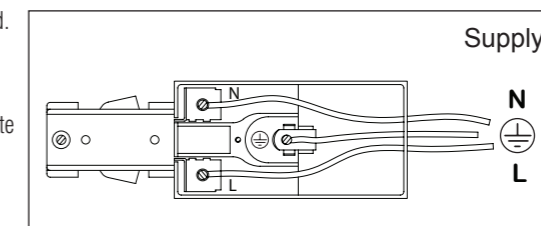

Check that...

- You have correctly identified the wires.
- The connections are tight.
- No loose strands have been left out of the connection block.