

VENTO EXPERT A50C3-1 S8 W V.2

HEAT RECOVERY SINGLE-ROOM UNITS

Features

- Extended temperature range up to -30 °C.
- Arrangement of efficient energy-saving, supply and exhaust, single-room ventilation in flats, houses, cottages, social and commercial premises.
- Reducing heat losses caused by ventilation due to heat recovery.
- Humidity balance and controllable air exchange create individually controlled microclimate.
- Wi-Fi data exchange between several single-room ventilation units for coordinated operation.
- Controlled by Android or iOS smartphone or tablet.



Air flow:
up to 50 m³/h
14 l/s



Heat recovery efficiency:
up to 93 %



Power: from 4.45 W
SFP: from 1.02 W/l/s



Noise level:
from 11 dBA



Operating temperature range:
up to -30 °C



Design

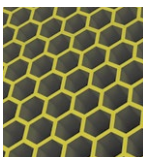
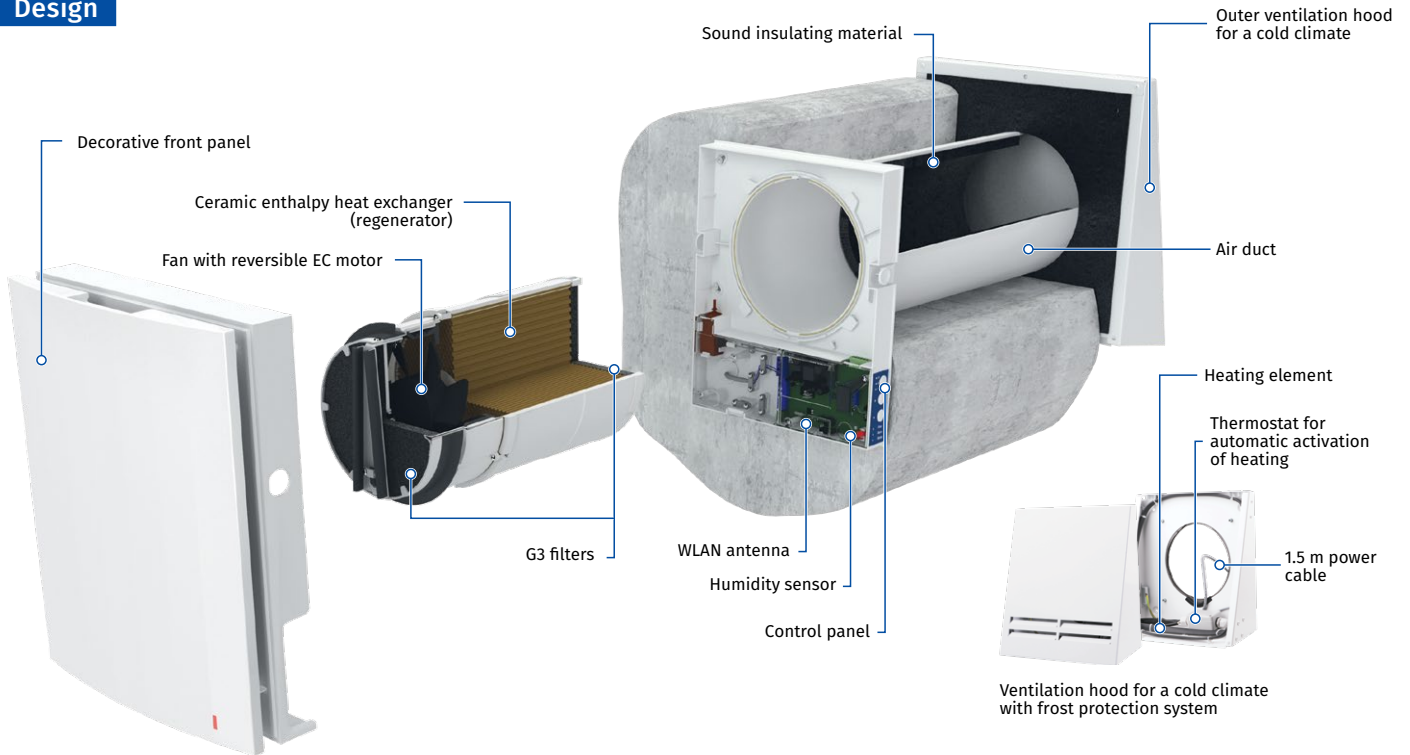

One of the best heat recovery efficiency on the market due to innovative hexagonal structure of the heat exchanger cells



Built-in Wi-Fi for wireless communication between units and Android or iOS device control



Integrated automatic air shutters prevent air back drafting



Easy maintenance. Indoor unit is opened by pressing the latches on both sides. The specially designed front panel can be closed manually to ensure 100 % air tightness and protect against wind impact

Designation key

Model	Air duct	Rated air flow [m ³ /h]	Cartridge type	Front panel type	Ventilation hood type	Control
Vento Expert	A: round air duct	50	C3: cartridge for a cold climate	-1: flat front panel	S8: ventilation hood for a cold climate with frost protection system	W V.2: control and setup of the unit with the Wi-Fi mobile application

VENTO EXPERT A50C3-1 S8 W V.2

HEAT RECOVERY SINGLE-ROOM UNITS

Control

- Unit control via smartphone or tablet application.
- The units can be connected by Wi-Fi for synchronized operation.
- House ventilation control via cloud service from anywhere in the world.
- Connection to smart house or Building Management System (BMS) via Wi-Fi.

Blauberg Vento V.2 app for Android or iOS devices is available at Google Play and App Store.

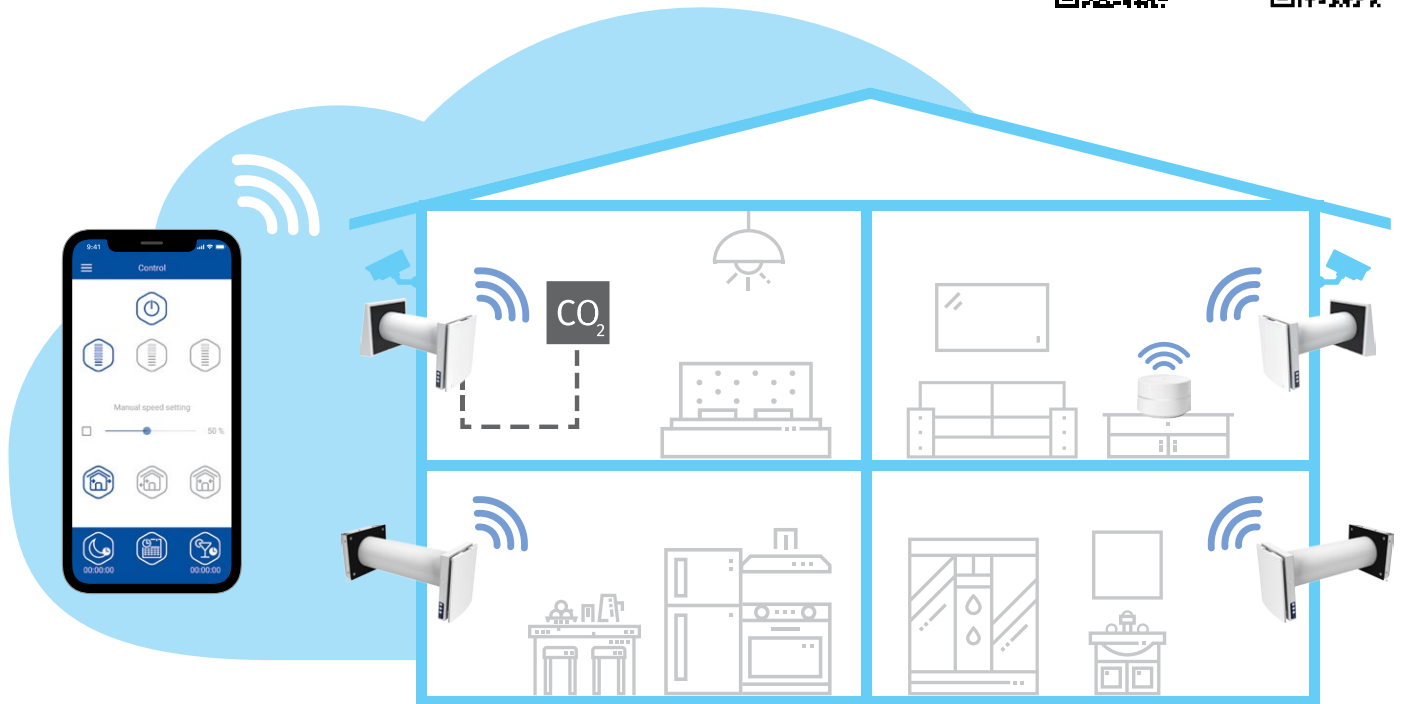

- Vento Expert A50C3-1 S8 W V.2 either can operate as independent unit or can be connected with other units in a house and controlled with a master unit. In this case, only the master unit receives a signal from the remote control.

- Control of the unit operation mode is also performed by means of the sensor control panel located on the unit casing or the remote control.

FOR LIVING ROOMS AND BEDROOMS



Vento Expert A50C3-1 S8 W V.2

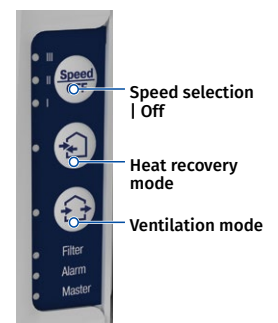
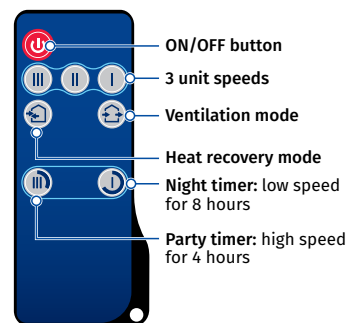

- Vento Expert A50C3-1 S8 W V.2 is equipped with a humidity sensor for indoor humidity control. If humidity increases above a set point, the unit boosts to the speed III.

VENTO EXPERT A50C3-1 S8 W V.2

HEAT RECOVERY SINGLE-ROOM UNITS

Energy recovery

UNIT OPERATING LOGIC IN WINTER PERIOD

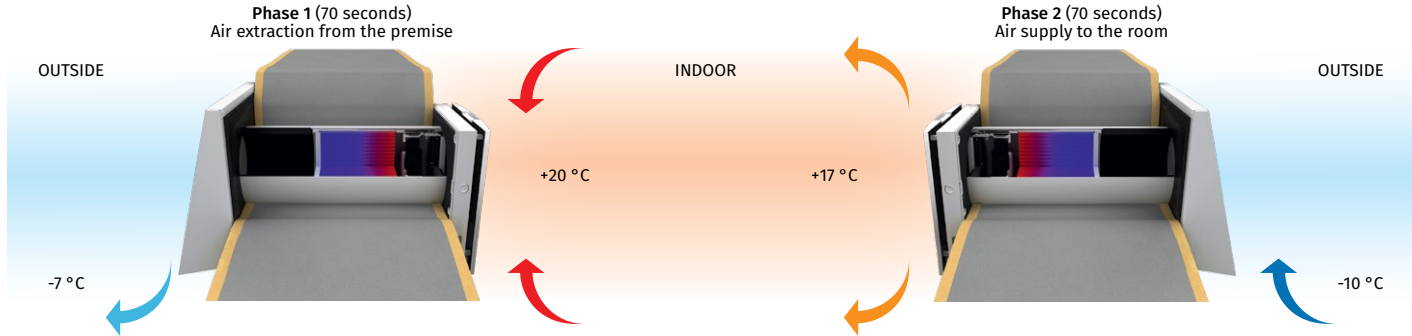

- Warm stale air is extracted from the premise, flows through the ceramic heat exchanger and transfers its heat and moisture to it.
- As the ceramic heat exchanger gets warmed up, the unit switches to the supply mode.
- Clean cold intake air flows through the heat exchanger and absorbs accumulated heat and humidity.
- When the heat exchanger is cooled down, the unit switches to the extract air mode.

Mounting

- The unit is designed for through-the-wall installation inside a prepared hole in an outer wall of the building.
- The best ventilation solution is pairwise installation of reverse phase synchronized units. Some units ensure supply of fresh air to the room and the other units extract air from the premise. This way the most efficient balanced ventilation is arranged.
- In case of brand new construction, units are mounted in two stages:
 - Pre-installation of an air duct and an outer ventilation hood at the stage of indoor finishing and outer decorative wall finishing.
 - Completion of the installation before commissioning of a house. It includes installation of the indoor unit with controller and shutters, the cartridge, the heat exchanger, the fan and the filters.

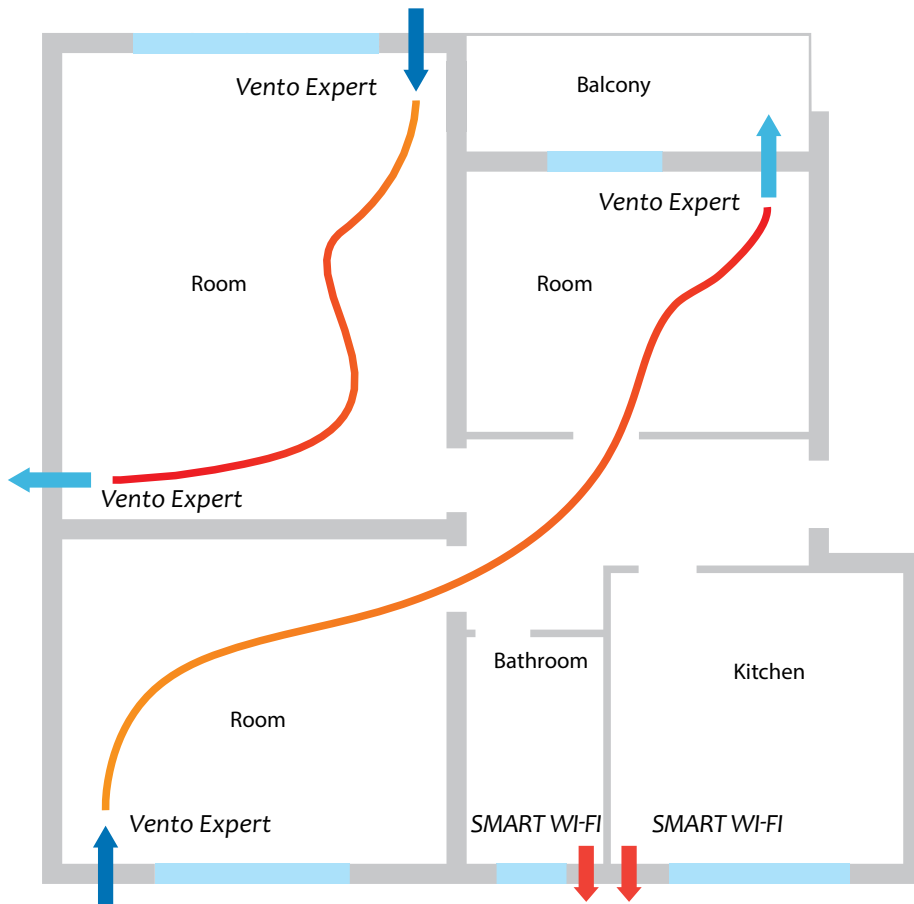

VENTO EXPERT A50C3-1 S8 W V.2

HEAT RECOVERY SINGLE-ROOM UNITS

Technical data

Parameters	Vento Expert A50C3-1 S8 W V.2		
	I	II	III
Speed			
Voltage [V / 50 (60) Hz]		100-240	
Capacity with hood heating element off [W]	4.45	5.08	7.06
Capacity with hood heating element on [W]	64.45	65.08	67.06
Current with hood heating element off [A]	0.035	0.040	0.059
Current with hood heating element on [A]	0.295	0.300	0.319
RPM [min ⁻¹]	800	1300	1900
Air flow in ventilation mode [m ³ /h (l/s)]	15 (4)	30 (8)	50 (14)
Air flow in energy recovery mode [m ³ /h (l/s)]	8 (2)	15 (4)	25 (7)
SFP [W/l/s]	2.14	1.22	1.02
Filter	G3 (Option: F8 PM2.5 > 99 %*)		
Transported air temperature [°C]	-30...+40		
Sound pressure level at 1 m in accordance with ISO 3741:2004 [dBA]	20	27	33
Sound pressure level at 3 m in accordance with ISO 3741:2004 [dBA]	11	18	24
Outdoor sound pressure attenuation in accordance with DIN EN 20140 [dBA]	42		
Classification of air flow sensitivity to pressure difference variations in accordance with EN 13141-8	S2**		
Indoor/outdoor airtightness classification of the complete unit in accordance with EN 13141-8	D1		
Heat recovery efficiency in accordance with DIBt LÜ-A 20 [%]	up to 93		
Ingress protection rating	IP24		

* maximum air flow 40 m³/h

** manual setting of 100% speed in a mobile application

The energy label displays the following information:

- Energy efficiency class: **A** (indicated by a black arrow pointing to the 'A' class on the scale).
- Sound power level: **38 dB** (indicated by a speaker icon).
- Air flow: **25 m³/h** (indicated by two arrows pointing up and down).
- Energy label scale: A+, A, B, C, D, E, F, G.
- Product name: Vento Expert A50C3-1 S8 W V.2.
- Manufacturer: BLAUBERG.
- Year: 2020.
- Standard: 1254/2014.

Overall dimensions [mm]

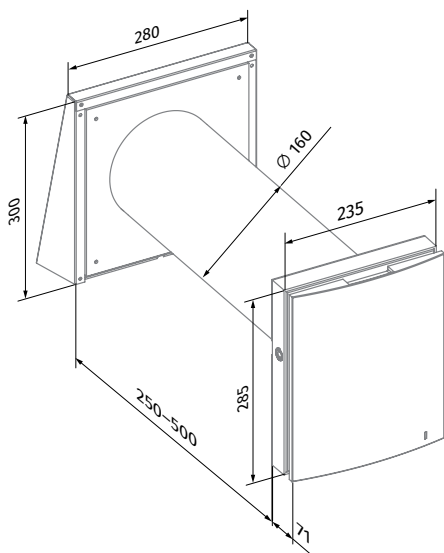













Vento Expert A50C3-1 S8 W V.2

VENTO EXPERT A50C3-1 S8 W V.2

HEAT RECOVERY SINGLE-ROOM UNITS

Accessories

Name		Description
Pre-installation Kit Vento Expert A50-1 S8		Pre-installation kit for mounting into walls with standard thickness. Includes: <ul style="list-style-type: none"> • Air duct • AH-8 white 160 outer ventilation hood • Polystyrene foam plug • Polystyrene foam wedges
Completion Kit Vento Expert A50C3-1 W V.2		Final mounting kit. Includes: <ul style="list-style-type: none"> • Cartridge with a heat exchanger, a fan and G3 filters • Indoor unit with a controller and shutters • Remote control
FP Vento Expert A50 G3		G3 filters (2 pcs.)
FP Vento Expert A50 F8		Filter set. Includes: <ul style="list-style-type: none"> • Plastic frame (1 pc.) • G2 pre-filter (1 pc.) • F8 filter (1 pc.). Filtration rate PM2.5 > 99 %
AH-8 white 160		White painted aluminium outer ventilation hood with frost protection for a cold climate
AH-8 chrome 160		Brushed stainless steel outer ventilation hood with frost protection for a cold climate
R 160-500		500 mm air duct and polystyrene foam plug
R 160-700		700 mm air duct and polystyrene foam plug
SE Vento Expert W		Sensor control panel
FB Vento Expert A50		Remote control
CD-1		CO ₂ sensor with LED CO ₂ indication and a sensor button for operation mode selection
CD-2		CO ₂ sensor
S Vento Expert A50		Cardboard template for indoor installation of the unit