

Series
VENTS VUT/VUE PBE EC
VENTS VUT/VUE PBW EC



Ceiling mounted air handling units in compact heat- and sound-insulated casing with an electric heater.
 Air flow up to **4300 m³/h**, heat recovery efficiency up to **90 %**.

■ **Description**

The VUT/VUE PBE EC air handling unit with an electric heater and the VUT/VUE PBW EC air handling unit with a water heater are the fully-featured ventilation units ensuring air filtration, fresh air supply and stale air extraction. The heat energy contained in extract air is transferred to supply air through the plate heat exchanger. The units are suitable for integration into various ventilation and air conditioning networks requiring cost-effective solutions and controllable ventilation. The integrated EC motors reduce energy demand by half up to three-fold and provide high air flow and low noise level. All the models are compatible with round 160, 200, 250, 315 and 400 mm air ducts.

■ **Modifications**

- VUT PBE EC** – models with an electric heater and a polystyrene or aluminium heat exchanger.
- VUE PBE EC** – models with an electric heater and an enthalpy heat exchanger.
- VUT PBW EC** – models with a water heater and a polystyrene or aluminium heat exchanger.
- VUE PBW EC** – models with a water heater and an enthalpy heat exchanger.

■ **Casing**

The heat- and sound-insulated aluzinc casing is internally filled with 20 mm mineral wool for the VUT 300, 55/900 PBE/PBW EC and 25 mm for VUT 2000/3000 PBE/PBW EC units.

■ **Filter**

To filter the supply and extract air, the unit has two built-in G4 filters. For the VUT/VUE 300/550/900 PBE/PBW EC models, a supply filter with an F7 degree of filtration can be installed as an option.

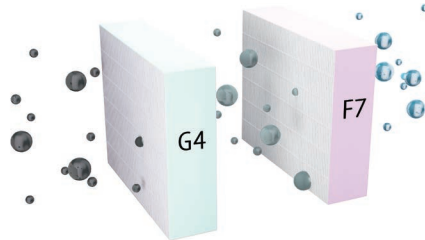

■ **Motor**

High-efficient electronically-commutated motors with external motor and impellers with backward curved blades. Such motors are the most state-of-the-art energy-saving solution. EC motors are featured with high performance and total speed controllable range. High efficiency reaching 90 % is the premium advantage of the electronically-commutated motors.

■ **Heat exchanger**

A plate counter-flow polystyrene heat exchanger which returns heat is used in the VUT 300/550/900 PBE/PBW EC units. To collect and drain condensate, the unit has a drain pan located under the heat exchanger.

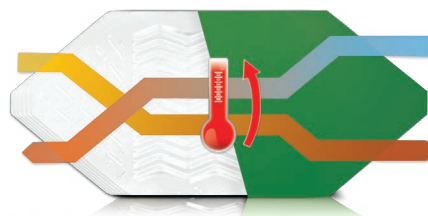

The VUT 2000/3000 PBE/PBW EC units are equipped with a cross-flow plate heat exchanger made of aluminium, which recovers heat.

To collect and drain condensate, the unit has a drain pan located under the heat exchanger.

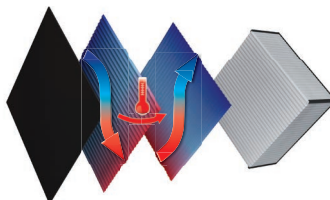

The VUE 300/550/900 PBE/PBW EC units use an enthalpy plate counter-flow heat exchanger that

returns heat and moisture. Due to the transfer of moisture, the enthalpy heat exchanger does not generate condensate.

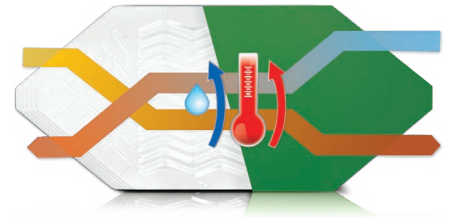

■ **Bypass**

The units are equipped with a bypass for summer ventilation (cooling of the premise with cool outside air) and freeze protection of the heat exchanger.

■ **Heater**

The electric heater (for the VUT/VUE PBE EC unit) or the water heater (for the VUT/VUE PBW EC unit), installed downstream of the heat exchanger, is designed for warming up of supply air up to the set level if heat recovery is not enough to attain the set supply air temperature. The water heaters are designed for max. operating pressure of 1.0 MPa (10 bar) and max. heat medium operating temperature of +95 °C.

■ **Control and automation**

The units are equipped with an integrated automation system. The A21 controller enables integration of the unit into the **Smart Home System** or **BMS (Building Management Systems)**. The remote control panel is not included in the delivery set (purchased separately). To control the unit via Wi-Fi, download the VENTS AHU mobile app.

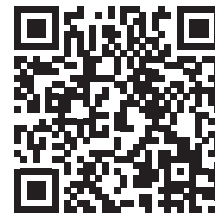

Google play



Download on the App Store





■ **Mounting**

The unit is designed for indoor mounting. While mounting the unit ensure its correct position to enable condensate collection and drainage.

Designation key

Series	Rated air flow [m ³ /h]	Mounting modification	Bypass	Heater type	Motor type	Service side	Control	Accessories
VUT: ventilation with heat recovery VUE: ventilation with energy recovery	300; 550; 900; 2000; 3000	P: suspended	B: Bypass	E: electric W: water	EC: synchronous electronically commutated motor	L: left R: right	A21	DTV: equipped with a differential pressure switch for controlling the contamination of filters

Control and automation

Functions	A21
Wi-Fi control via mobile application	+
Control via wired remote control panel	option (A22) 
Control via wired remote LCD control panel	option (A25) 
Control via wireless remote control panel	option (A22 Wi-Fi) 
BMS	RS-485 Wi-Fi Ethernet MODBUS (RTU, TCP)
Service Vents Cloud Server	+
Speed selection	+
Filter replacement indication	according to a filter timer according to a pressure switch of filter clogging for the units with DTV
Alarm indication	full alarm description in the mobile application
Week-scheduled operation	+
Bypass	auto
	manual
Timer	+
Boost mode	+
Fireplace mode	+
Freeze protection	cyclic shutdown of the supply fan
	through preheating (option) using a bypass
Cooler connection	option
Reheater connection	option
Control of minimum supply air temperature	+
Humidity control	option
CO ₂ control	option
VOC control	option
PM2.5 control	option
Fire alarm sensor	option

*Option. The functionality is available when you purchase the appropriate accessory.

Unit overall dimensions

Type	Dimensions [mm]					
	∅D	B	B1	H	L	L1
VUT/VUE 300 PBE EC	160	485	577	280	1238	1291
VUT/VUE 550 PBE/PBW EC	200	827	960	280	1238	1291
VUT/VUE 900 PBE/PBW EC	250	1351	1485	318	1349	1402
VUT 2000 PBE/PBW EC	315	950	-	762	1400	1452
VUT 3000 PBE/PBW EC	400	1265	-	881	1835	1888

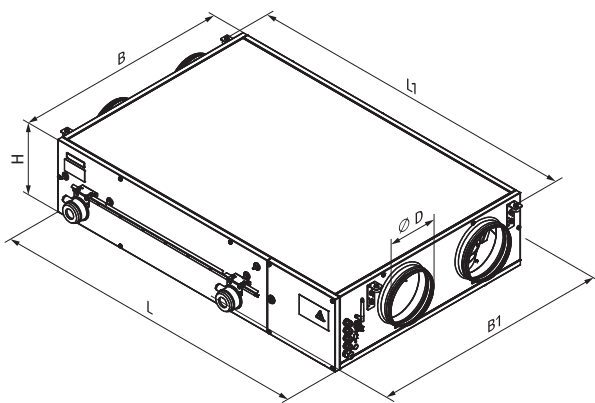

VUT/VUE 550 PBE EC
VUT/VUE 550 PBW EC

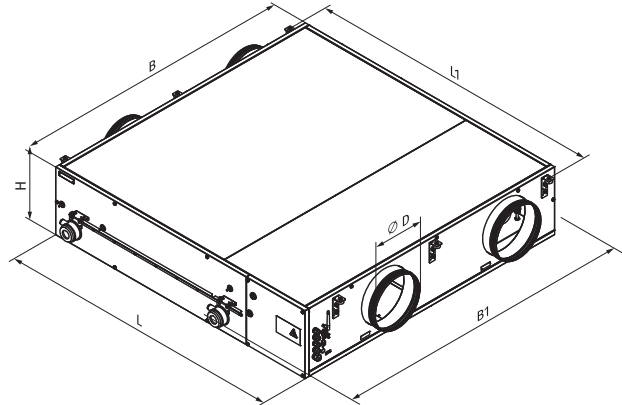

VUT/VUE 900 PBE EC
VUT/VUE 900 PBW EC

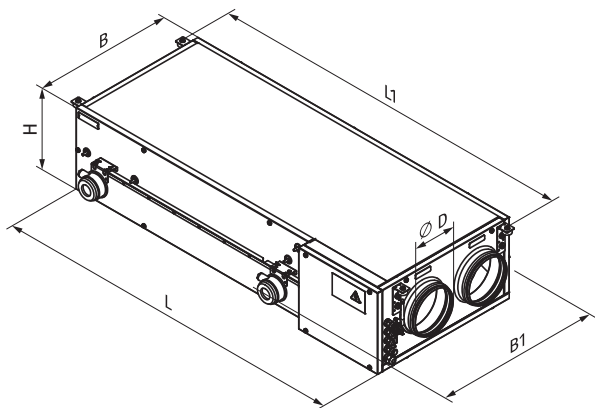

VUT/VUE 300 PBE EC

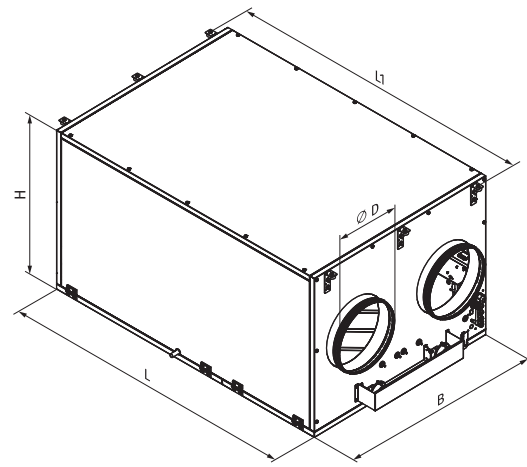

VUT 2000(3000) PBE EC
VUT 2000(3000) PBW EC

Technical data

	VUT 300 PBE EC	VUE 300 PBE EC	VUT 550 PBE EC	VUE 550 PBE EC	VUT 550 PBW EC	VUE 550 PBW EC
Voltage [V/50-60 Hz]	1~230		1~230		1~230	
Max. unit power without electric heater [W]	180		297		297	
Integrated electric heater power [W]	1500		2000		-	
Max. unit power with electric heater [W]	1 680		2 297		297	
Max. unit current without electric heater [A]	1.4		2.4		2.4	
Integrated electric heater current [A]	6.5		8.7		-	
Max. unit current with electric heater [A]	7.9		11.1		2.4	
Number of water (glycol) coil rows	-		-		2	
Max. air flow [m ³ /h]	340		620		620	
RPM [min ⁻¹]	3270		3100		3100	
Sound pressure level at 3 m distance [dBA]	27		30		30	
Max. transported air temperature [°C]			-25...+40			
Casing material	aluzinc					
Insulation	20 mm, mineral wool					
Extract filter	G4					
Supply filter	G4 (F7 option)					
Connected air duct diameter [mm]	160		200		200	
Weight [kg]	44		67		68	
Heat recovery efficiency [%]	72-90	69-87	78-90	69-87	78-90	69-87
Heat exchanger type	counter-flow					
Heat exchanger material	polystyrene	enthalpy	polystyrene	enthalpy	polystyrene	enthalpy
SEC class	A		A		A	

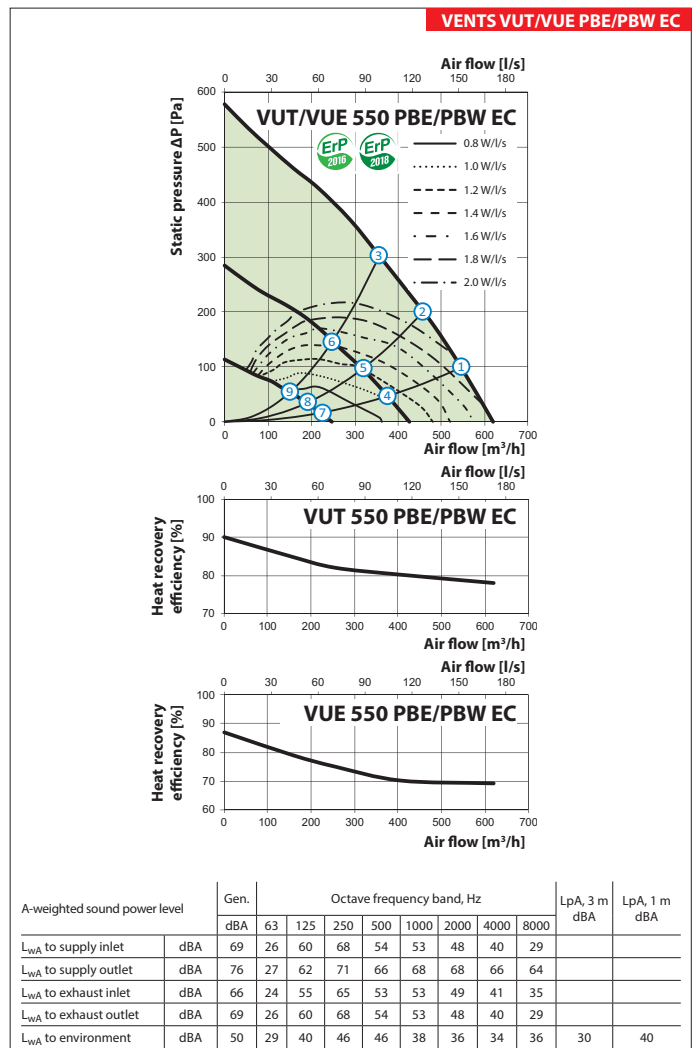
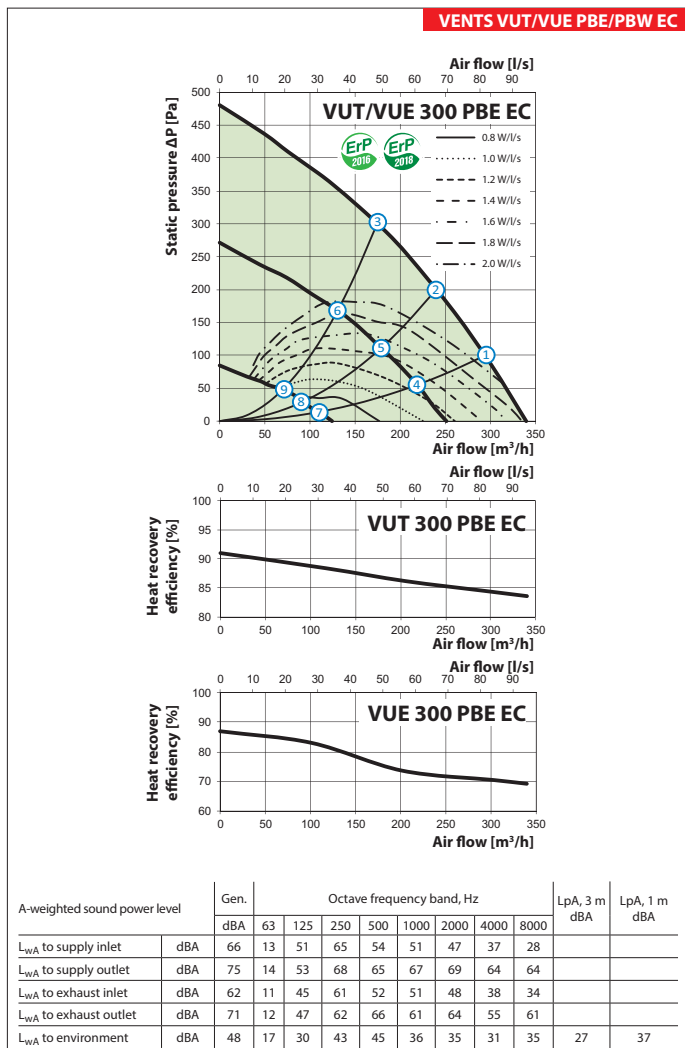

AIR HANDLING UNITS WITH HEAT RECOVERY

Technical data

	VUT 900 PBE EC	VUE 900 PBE EC	VUT 900 PBW EC	VUE 900 PBW EC
Voltage [V/50-60 Hz]	1~230		1~230	
Max. unit power without electric heater [W]	442		442	
Integrated electric heater power [W]	3300		-	
Max. unit power with electric heater [W]	3742		442	
Max. unit current without electric heater [A]	3.1		3	
Integrated electric heater current [A]	14.3		-	
Max. unit current with electric heater [A]	17.4		3	
Number of water (glycol) coil rows	-		2	
Max. air flow [m ³ /h]	1030		1030	
RPM [min ⁻¹]	2720		2720	
Sound pressure level at 3 m distance [dBA]	33		33	
Max. transported air temperature [°C]	-25...+40		-25...+40	
Casing material	aluzinc			
Insulation	20 mm, mineral wool			
Extract filter	G4			
Supply filter	G4 (F7 option)			
Connected air duct diameter [mm]	250		250	
Weight [kg]	111		112	
Heat recovery efficiency [%]	75-88	69-85	75-88	69-85
Heat exchanger type	counter-flow			
Heat exchanger material	polystyrene	enthalpy	polystyrene	enthalpy
SEC class	A	A	A	A

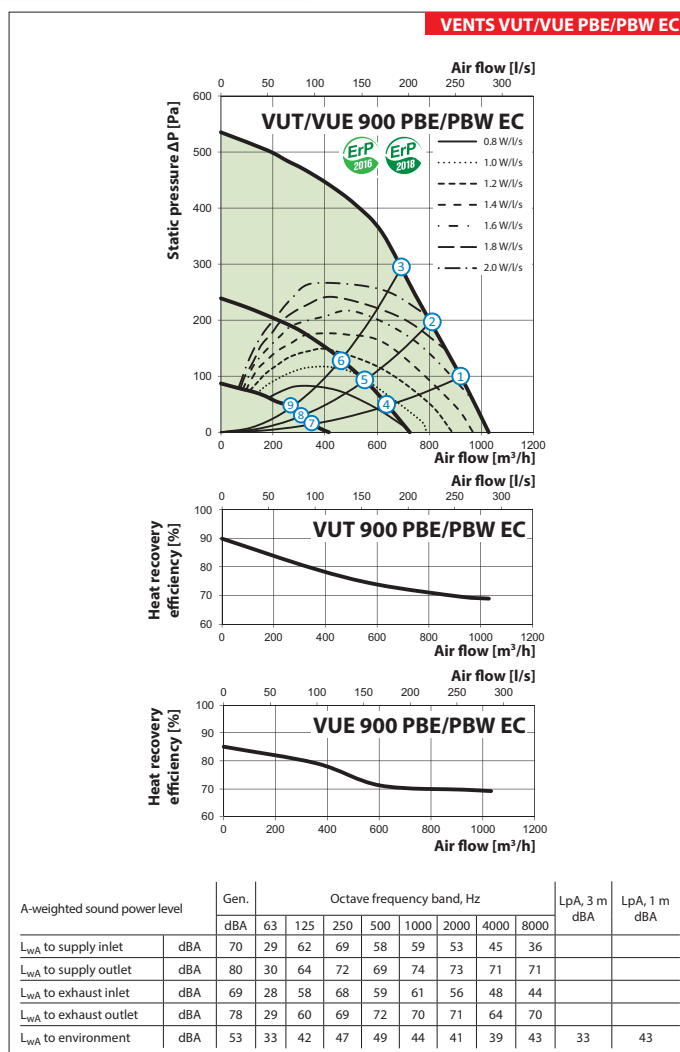

Technical data



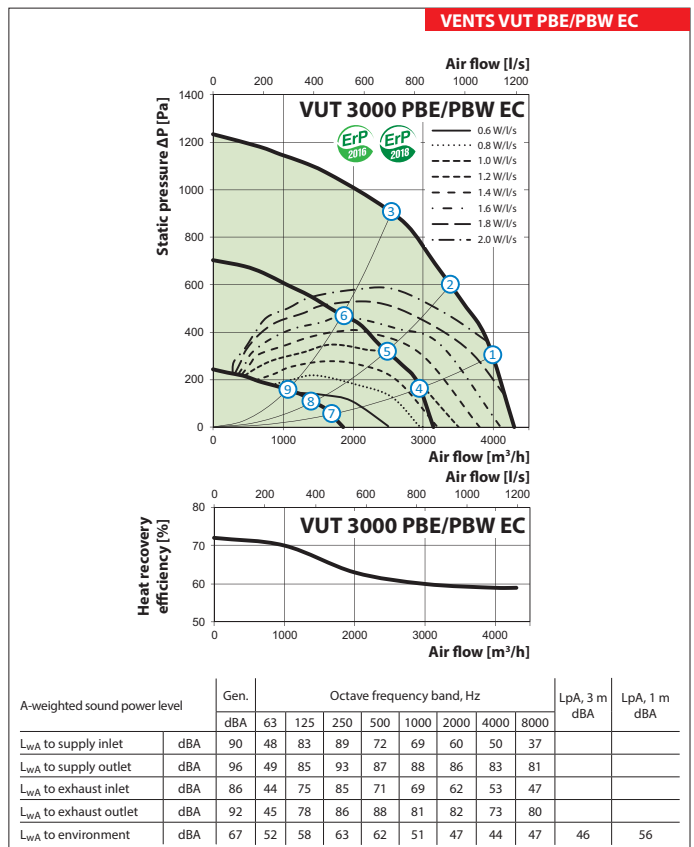
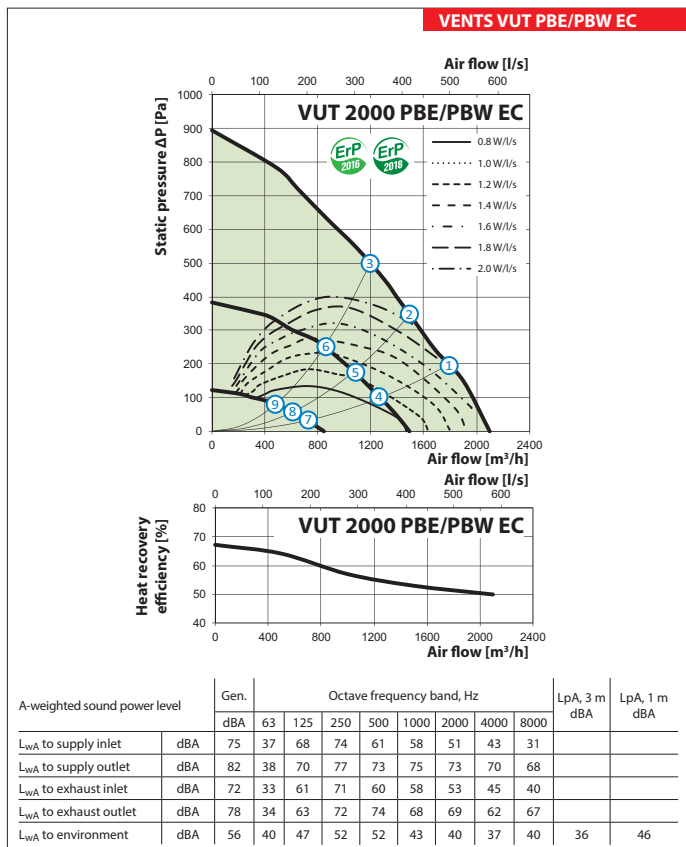









	VUT 2000 PBE EC	VUT 2000 PBW EC	VUT 3000 PBE EC	VUT 3000 PBW EC
Voltage [V/50-60 Hz]	3~400	1~230	3~400	
Max. unit power without electric heater [W]		876		2226
Integrated electric heater power [W]	15000	-	21000	-
Max. unit power with electric heater [W]	15876	876	23226	2 226
Max. unit current without electric heater [A]		5.3		3.5
Integrated electric heater current [A]	21.7	-	30	-
Max. unit current with electric heater [A]	27.0	5.3	33.5	3.5
Number of water (glycol) coil rows	-	2	-	2
Max. air flow [m ³ /h]		2100		4300
RPM [min ⁻¹]		2920		3400
Sound pressure level at 3 m distance [dBA]		36		46
Max. transported air temperature [°C]		-25...+40		-25+40
Casing material	aluzinc			
Insulation	20 mm, mineral wool			
Extract filter	G4			
Supply filter	G4			
Connected air duct diameter [mm]	315		400	
Weight [kg]	140		281	268
Heat recovery efficiency [%]	50-67		59-72	
Heat exchanger type	cross-flow type			
Heat exchanger material	aluminum			
SEC class	NRVU			



AIR HANDLING UNITS WITH HEAT RECOVERY

Point	Unit power [W]				
	VUT/VUE 300 PBE EC	VUT/VUE 550 PBE/PBW EC	VUT 900 PBE/PBW EC	VUT 2000 PBE/PBW EC	VUT 3000 PBE/PBW EC
1	174	294	442	875	2200
2	168	285	442	866	2220
3	152	271	442	836	2143
4	77	109	160	320	858
5	74	106	149	318	868
6	68	101	147	301	840
7	19	34	46	84	198
8	19	34	43	84	200
9	18	32	40	74	162

Accessories for air handling units

Model	G4 pocket filter	F7 pocket filter	G4 panel filter	Control panel	Wi-Fi control-lable control panel	LCD control panel	Humidity sensor (0-10 V)	CO ₂ sensor	CO ₂ sensor with indication	Humidity sensor	VOC sensor (0-10 V)	CO ₂ sensor (0-10 V)	Humidity sensor (0-10 V)
													
VUT 300 PBE EC A21	SFK 208x236x27 G4	SFK 208x236x27 F7	SF 440x128x20 G4										
VUT 550 PBE EC A21	SFK 392x236x27 G4	SFK 392x236x27 F7	SF 782x128x20 G4										
VUT 900 PBE EC A21	SFK 647x274x27 G4	SFK 647x274x27 F7	SF 647x274x20 G4										
VUE 300 PBE EC A21	SFK 208x236x27 G4	SFK 208x236x27 F7	SF 440x128x20 G4										
VUE 550 PBE EC A21	SFK 392x236x27 G4	SFK 392x236x27 F7	SF 782x128x20 G4										
VUE 900 PBE EC A21	SFK 647x274x27 G4	SFK 647x274x27 F7	SF 647x274x20 G4										
VUT 2000 PBE EC A21	-	-	SF 708x480x48 G4	A22	A22 WiFi	A25	HV2	CO2-1	CO2-2	HR-S	DPWQ 30600	DPWQ 40200	DPWC 11200
VUT 3000 PBE EC A21	-	-	SF 827x741x48 G4										
VUT 550 PBW EC A21	SFK 392x236x27 G4	SFK 392x236x27 F7	SF 782x128x20 G4										
VUT 900 PBW EC A21	SFK 647x274x27 G4	SFK 647x274x27 F7	SF 647x274x20 G4										
VUE 550 PBW EC A21	SFK 392x236x27 G4	SFK 392x236x27 F7	SF 782x128x20 G4										
VUE 900 PBW EC A21	SFK 647x274x27 G4	SFK 647x274x27 F7	SF 647x274x20 G4										
VUT 2000 PBW EC A21	-	-	SF 708x480x48 G4										
VUT 3000 PBW EC A21	-	-	SF 827x741x48 G4										

Model	Kitchen hood	Hydraulic U-trap	Silencer		Backdraft damper	Air damper	Clamps	Electric actuators		Mixing unit
VUT 300 PBE EC A21			SR 160 600/900/1200	SRF 160 600/900/1200	KOM 160	KRV 160	C 160			
VUT 550 PBE EC A21		SH-32	SR 200 600/900/1200	SRF 200 600/900/1200	KOM 200	KRV 200	C 200			
VUT 900 PBE EC A21			SR 250 600/900/1200	SRF 250 600/900/1200	KOM 250	KRV 250	C 250			
VUE 300 PBE EC A21			SR 160 600/900/1200	SRF 160 600/900/1200	KOM 160	KRV 160	C 160			
VUE 550 PBE EC A21		-	SR 200 600/900/1200	SRF 200 600/900/1200	KOM 200	KRV 200	C 200			
VUE 900 PBE EC A21			SR 250 600/900/1200	SRF 250 600/900/1200	KOM 250	KRV 250	C 250			
VUT 2000 PBE EC A21			SR 315 600/900/1200	SRF 315 600/900/1200	KOM 315	KRV 315	C 315			
VUT 3000 PBE EC A21	KH-1		SR 400 600/900/1200	-	KOM 400	KRV 400	C 400	LF230	TF230	
VUT 550 PBW EC A21		SH-32	SR 200 600/900/1200	SRF 200 600/900/1200	KOM 200	KRV 200	C 200			
VUT 900 PBW EC A21			SR 250 600/900/1200	SRF 250 600/900/1200	KOM 250	KRV 250	C 250			
VUE 550 PBW EC A21			SR 200 600/900/1200	SRF 200 600/900/1200	KOM 200	KRV 200	C 200			
VUE 900 PBW EC A21		-	SR 250 600/900/1200	SRF 250 600/900/1200	KOM 250	KRV 250	C 250			USWK
VUT 2000 PBW EC A21			SR 315 600/900/1200	SRF 315 600/900/1200	KOM 315	KRV 315	C 315			
VUT 3000 PBW EC A21		SH-32	SR 400 600/900/1200	-	KOM 400	KRV 400	C 400			

Water heater parameters calculation

VUT PBW EC

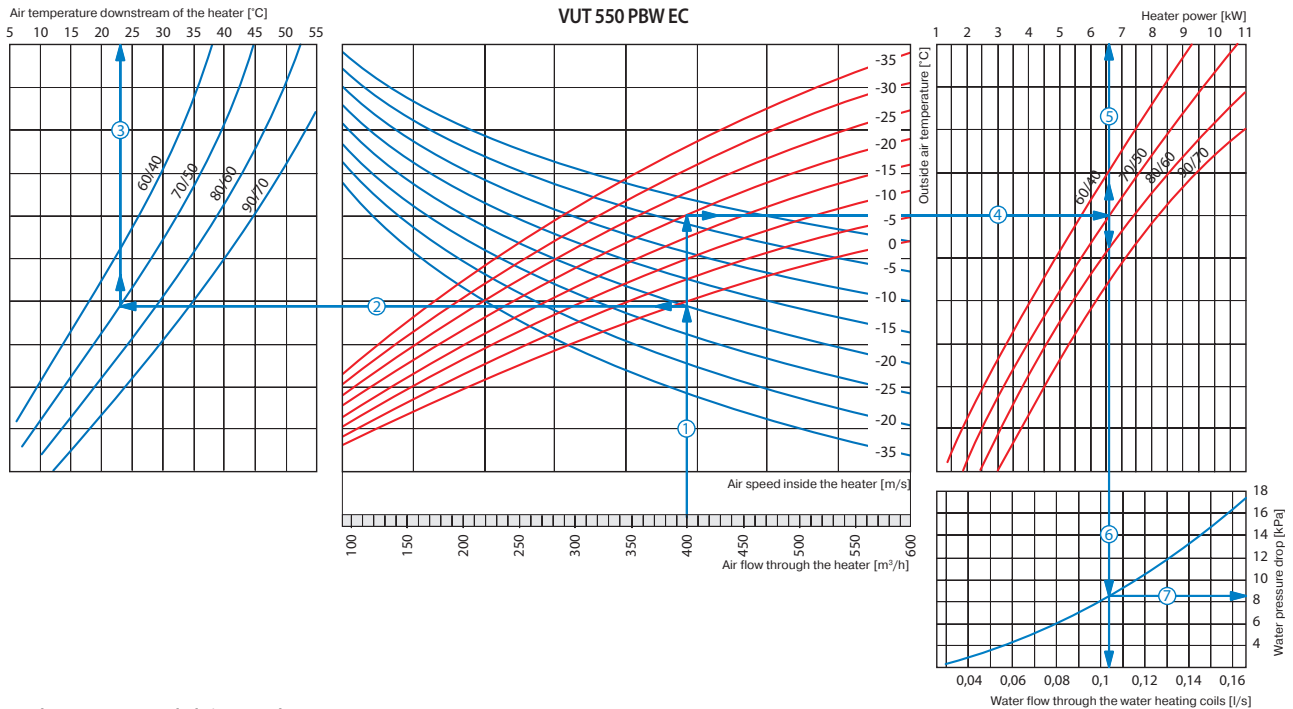

Water heater parameters calculation example

- To calculate the maximum air temperature, find the intersection point of the air flow line ① with the rated winter temperature shown in blue line (e.g., 400 m³/h) and draw the line ② to the left until it crosses the water in/out temperature curve (e.g. +70/+50). From this point draw a vertical line to the supply air temperature downstream of the heater (+23 °C) ③.
- To calculate the heater power, find the intersection point of the air flow ① with the rated winter temperature shown in red line (e.g., -20 °C) and draw the line ④ to the right until it crosses the water in/out temperature curve (e.g. +70/+50). From this point draw a vertical line to the heater power axis (6.6 kW) ⑤.
- To calculate the required water flow in the heater, prolong this line ⑤ downwards to the water flow axis (0,105 l/s).
- To calculate the water pressure drop in the heater, find the intersection point of the line ⑥ with the pressure loss curve and prolong the line ⑦ to the right on the water pressure drop axis (8.5 kPa).

VUT PBW EC

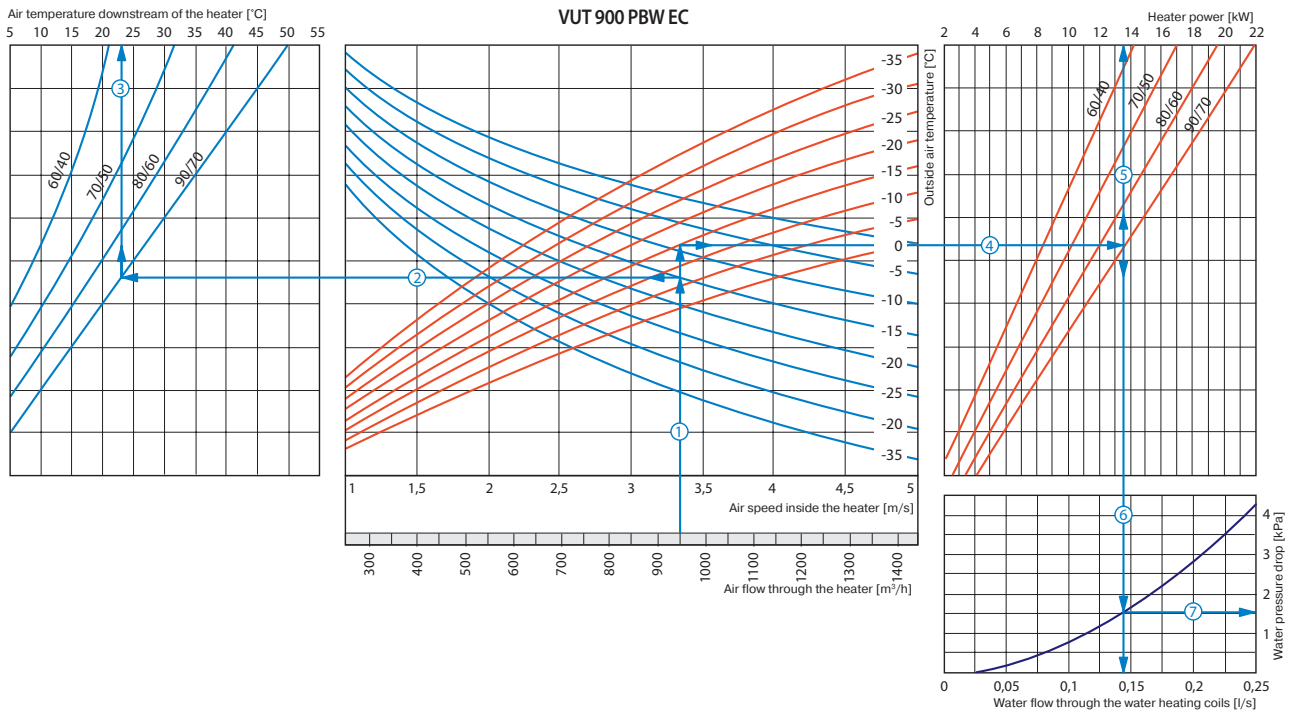

Water heater parameters calculation example

The air flow is 950 m³/h and the air speed in the heater is 3.35 m/s ①.

- To calculate the maximum air temperature, find the intersection point of the air flow line ① with the rated winter temperature shown in blue line (e.g., -15 °C) and draw the line ② to the left until it crosses the water in/out temperature curve (e.g. +90/+70). From this point draw a vertical line to the supply air temperature downstream of the heater (+23 °C) ③.
- To calculate the heater power, find the intersection point of the air flow ① with the rated winter temperature shown in red line (e.g., -20 °C) and draw the line ④ to the right until it crosses the water in/out temperature curve (e.g. +90/+70). From this point draw a vertical line to the heater power axis (13.5 kW) ⑤.
- To calculate the required water flow in the heater, prolong this line ⑤ downwards to the water flow axis (0,14 l/s).
- To calculate the water pressure drop in the heater, find the intersection point of the line ⑥ with the pressure loss curve and prolong the line ⑦ to the right on the water pressure drop axis (1.5 kPa).

Water heater parameters calculation

VUT PBW EC

Air temperature downstream of the heater [°C]
5 20 25 30 35 40 45 50 55 60 65

VUT 2000 PBW EC

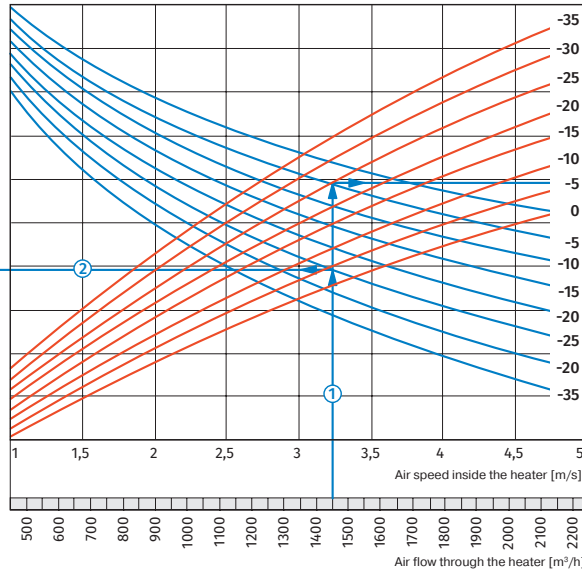
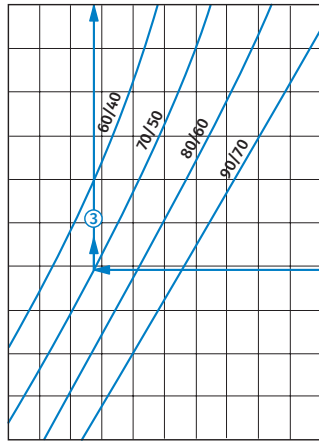

Heater power [kW]
10 15 20 25 30 32 40 45 50

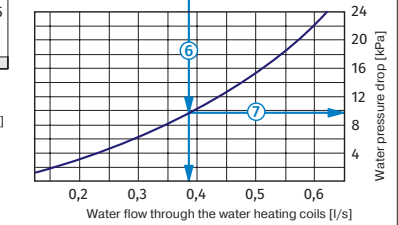
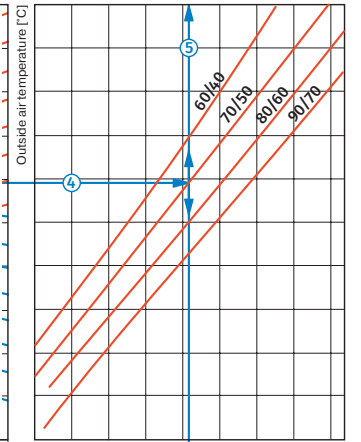

Water heater parameters calculation example

The air flow is 1450 m³/h and the air speed in the heater is 3.2 m/s ①.

- To calculate the maximum air temperature, find the intersection point of the air flow line ① with the rated winter temperature shown in blue line (e.g., -25 °C) and draw the line ② to the left until it crosses the water in/out temperature curve (e.g. +70/+50). From this point draw a vertical line to the supply air temperature downstream of the heater (+28 °C) ③.
- To calculate the heater power, find the intersection point of the air flow ① with the rated winter temperature shown in red line (e.g., -25 °C) and draw the line ④ to the right until it crosses the water in/out temperature curve (e.g. +70/+50). From this point draw a vertical line to the heater power axis (31 kW) ⑤.
- To calculate the required water flow in the heater, prolong this line ⑥ downwards to the water flow axis (0,38 l/s).
- To calculate the water pressure drop in the heater, find the intersection point of the line ⑥ with the pressure loss curve and prolong the line ⑦ to the right on the water pressure drop axis (9,8 kPa).

VUT PBW EC

Air temperature downstream of the heater [°C]
5 10 15 20 25 30 35 40 45 50 55

VUT 3000 PBW EC

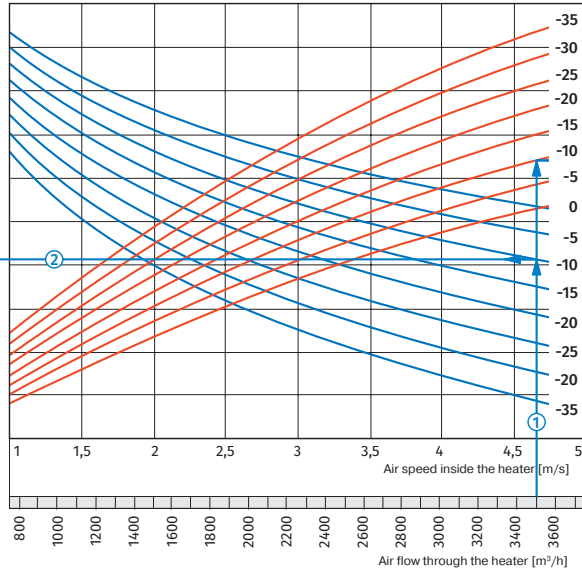
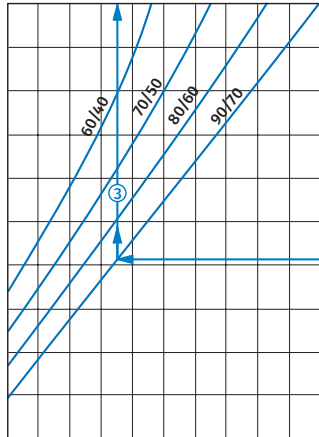

Heater power [kW]
10 20 30 40 50 60

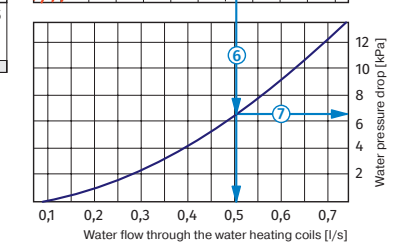
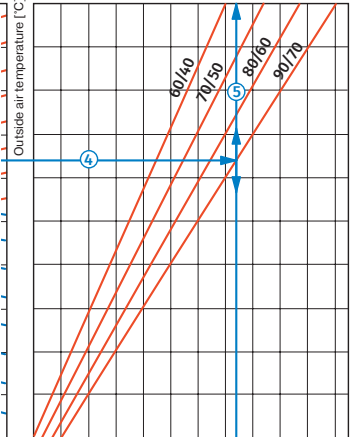

Water heater parameters calculation example

The air flow is 3500 m³/h and the air speed in the heater is 4.65 m/s ①.

- To calculate the maximum air temperature, find the intersection point of the air flow line ① with the rated winter temperature shown in blue line (e.g., -10 °C) and draw the line ② to the left until it crosses the water in/out temperature curve (e.g. +90/+70). From this point draw a vertical line to the supply air temperature downstream of the heater (+22,5 °C) ③.
- To calculate the heater power, find the intersection point of the air flow ① with the rated winter temperature shown in red line (e.g., -10 °C) and draw the line ④ to the right until it crosses the water in/out temperature curve (e.g. +90/+70). From this point draw a vertical line to the heater power axis (42 kW) ⑤.
- To calculate the required water flow in the heater, prolong this line ⑥ downwards to the water flow axis (0,5 l/s).
- To calculate the water pressure drop in the heater, find the intersection point of the line ⑥ with the pressure loss curve and prolong the line ⑦ to the right on the water pressure drop axis (6,5 kPa).