

ATyS g M

Automatic Transfer Switching Equipment





1. GENERAL SAFETY INSTRUCTIONS	4
2. INTRODUCTION	5
2.1. The ATyS family product range	5
2.2. The ATyS M Range Key Features	6
2.2.1. Selection guide	7
3. QUICK START	8
3.1. Quick Start ATyS g M (2P)	8
3.2. Quick Start ATyS g M (4P)	12
4. ATYS G M VERSIONS	15
4.1. Product presentation	15
4.2. Specifications and advantages	15
4.3. Supply types	15
5. OPTIONAL ACCESSORIES	16
6. TECHNICAL DATA	17
7. ENVIRONMENTAL CONDITIONS	18
8. PRODUCT INSTALLATION	19
8.1. Changing the padlocking configuration	19
8.2. Recommended orientation	19
8.3. Dimensions of the single phase	19
8.4. Back plate mounted single phase	19
8.5. Dimensions of the three phase	20
8.6. Back plate mounted three phase	20
8.7. DIN rail mounted	20
9. INSTALLATION OF OPTIONAL ACCESSORIES	21
9.1. Auxilliary contacts	21
9.2. Voltage sensing and power supply tap	21
9.3. Bridging bars 2P	21
9.4. Bridging bars 4P	22
9.5. Terminal shrouds	22
9.6. Sealable cover	22
10. INSTALLING WITHIN THE ATYS M ENCLOSURE	23
10.1. Modular plastic enclosure	23
10.2. Polycarbonate enclosure	24
10.2.1. Wiring in a polycarbonate enclosure	24
10.2.2. Extension unit	24

11. CONNECTION OF THE POWER CIRCUITS	25
11.1. Ratings / cross-sections table of correspondence	25
11.2. Parallel pole set-up for a 4P device used in single phase	25
11.3. Network configurations	26
11.3.1. 230VAC network configurations (2P)	26
11.3.2. Configurations réseau 230/400 VAC (4P)	26
11.3.3. Configurations réseau 127 / 230 VAC	27
11.3.4. Three phase without neutral network	28
11.3.4.1. Auto-transformer connections	28
11.3.4.2. Procedure for the configuration and storage of the neutral position	29
11.3.4.3. Reset of neutral position	29
12. CONNECTION OF CONTROL/COMMAND CIRCUITS	30
12.1. Terminal connectors designation	31
12.2. Auxiliary contact operating schedule	32
13. OPERATION	33
13.1. Presentation of the product interface	33
13.1.1. 2P product interface	33
13.1.2. 4P product interface	33
13.1.3. Reset	34
13.2. Manual mode	34
13.2.1. Manual switching	34
13.3. Padlocking	35
13.4. Programming	36
13.4.1. Single phase versionw	36
13.4.2. Three phase version	37
13.4.3. Sealable configuration cover	38
13.5. Automatic mode	38
13.5.1. Sealable Auto/Manual cover	38
13.6. Possible actions	38
13.7. Manual & Automatic Mode / Mains restoration conditions	39
13.7.1. Mode 1: Automatic retransfer	39
13.7.2. Mode 2a: Controlled retransfer	41
13.7.3. Mode 2b: Controlled transfer	43
13.7.4. Mode 3: Network - Network application with priority	44
13.7.5. Mode 4: Network - Network application without priority	47
14. PREVENTATIVE MAINTENANCE	49
15. TROUBLESHOOTING GUIDE	50

1. GENERAL SAFETY INSTRUCTIONS

- This manual provides instructions on safety, connections and operation of the ATyS M transfer switch manufactured by SOCOMEC.
- Whether the ATyS is sold as a loose product, as a spare, as an enclosed solution or as any other configuration, this device must always be installed and commissioned by qualified and experienced personnel, in line with the manufacturers recommendations, following good engineering practices and after having read and understood the details in the latest release of the relative product instruction manual.
- Maintenance on the product and any other associated equipment including but not limited to servicing operations must be performed by adequately trained and qualified personnel.
- Each product is shipped with a label or other form of marking including rating and other important specific product information. One must also refer to and respect markings on the product prior to installation and commissioning for values and limits specific to that product.
- Using the product outside the intended scope, outside SOCOMEC recommendations or outside the specified ratings and limits can cause personal injury and/or damage to equipment.
- This instruction manual must be made accessible so as to be easily available to anyone who may need to read it in relation with the ATyS.
- The ATyS meets the European Directives governing this type of product and includes CE marking on each product.
- No covers other than that for auto/manu on the ATyS should be opened (with or without voltage) as there may still be dangerous voltages inside the product such as those from external circuits.
- **Do not handle any control or power cables connected to the ATyS when voltage may be present on the product directly through the mains or indirectly through external circuits.**
- Voltages associated with this product may cause injury, electric shock, burns or death. Prior to carry out any maintenance or other work on live parts or other parts in the vicinity of exposed live parts, ensure that the switch including all control and associated circuits are de-energized.

 DANGER	 WARNING	 CAUTION
RISK: Electric shock, burns, death	RISK: Possible personal injury	RISK: Equipment damage

- As a minimum the ATyS M comply with the following international standards:
 - IEC 60947-6-1
 - GB 14048-11
 - EN 60947-6-1
 - VDE 0660-107
 - BS EN 60947-6-1
 - NBN EN 60947-6-1
 - IEC 60947-3
 - IS 13947-3
 - EN 60947-3
 - NBN EN 60947-3
 - BS EN 60947-3

The information provided in this instruction manual is subject to change without notice, remains for general information only and is non-contractual.

2. INTRODUCTION

ATyS g M “Automatic Transfer Switching Equipment” (ATSE) is designed for use in power systems for the safe transfer of a load supply between a normal and an alternate source. The changeover is done in open transition and with minimum supply interruption during transfer ensuring full compliance with IEC 60947-6-1, GB 14048-11 and other international TSE standards as listed.

The ATyS g M is a full load break (switch type) derived transfer switching equipment where the main components are proven technology devices also fulfilling requirements in IEC 60947-3 standards.





As a Class PC ATSE, the ATyS g M is capable of “making and withstanding short circuit currents” assigned to IEC 60947-3 utilization categories of up to AC23A, GB 14048-11, IEC 60947-6-1 and equivalent standards with utilization categories of up to AC33B.

ATyS g M transfer switches ensure:

- Power Control and Safety between a normal and an alternate source.
- A complete product delivered as a fully assembled and tested solution.
- Intuitive HMI for emergency / local operation.
- Integrated and robust switch disconnection.
- Window with clearly visible position indication I – 0 - II.
- An inherent failsafe mechanical interlock.
- Stable positions (I – 0 – II) non affected by typical vibration and shocks.
- Constant pressure on the contacts non affected by network voltage.
- Energy Efficient with virtually no consumption whilst on the normal, alternate or off positions.
- Extremely rugged, error free and built in padlocking facility (configurable).
- Straight forward installation with effective ergonomics.
- Simple motorization control interface.
- ATS configuration through 4 potentiometers and DIP switches.
- Auxiliary contacts for switch positions I – 0 - II (optional).
- “Product availability” output.
- Ample accessories to suit specific requirements.
- Fully integrated ATS controller specifically designed for Mains / Mains and Mains / Genset applications.

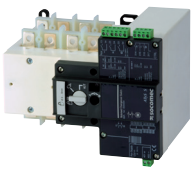
2.1. The ATyS family product range

Just the right ATyS for your application...

ATyS: Small Footprint		ATyS M: Modular Profile	
<p>Back to Back Configuration</p>  <p>40A - 125A</p> <p>ATyS d S Small Genset with DPS</p> <p>ATyS S (RTSE) Small Gense</p>	 <p>125A - 3200A</p> <p>ATyS p Power / Genset Management</p> <p>ATyS g Simple Genset Management</p> <p>ATyS t Transformer Management</p> <p>ATyS d RTSE (DPS)</p> <p>ATyS r RTSE</p> <p>⁽¹⁾ ATyS  RTSE</p>	 <p>40A - 160A</p> <p>ATyS p M Evolved Genset Management</p> <p>ATyS g M Simple Genset Management</p> <p>ATyS t M Transformer (building) Management</p> <p>ATyS d M RTSE (DPS)</p>	<p>Side by Side Configuration</p>

⁽¹⁾ The UL version of ATyS r is available from 100 - 400A

2.2. The ATyS M Range Key Features

Selecting the right ATyS M will depend on the application, the functionality required as well as the nature of the installation in which the ATyS M will be installed. Below is an outline product selection chart listing the key features of each product to help you select the right ATyS M for your needs.

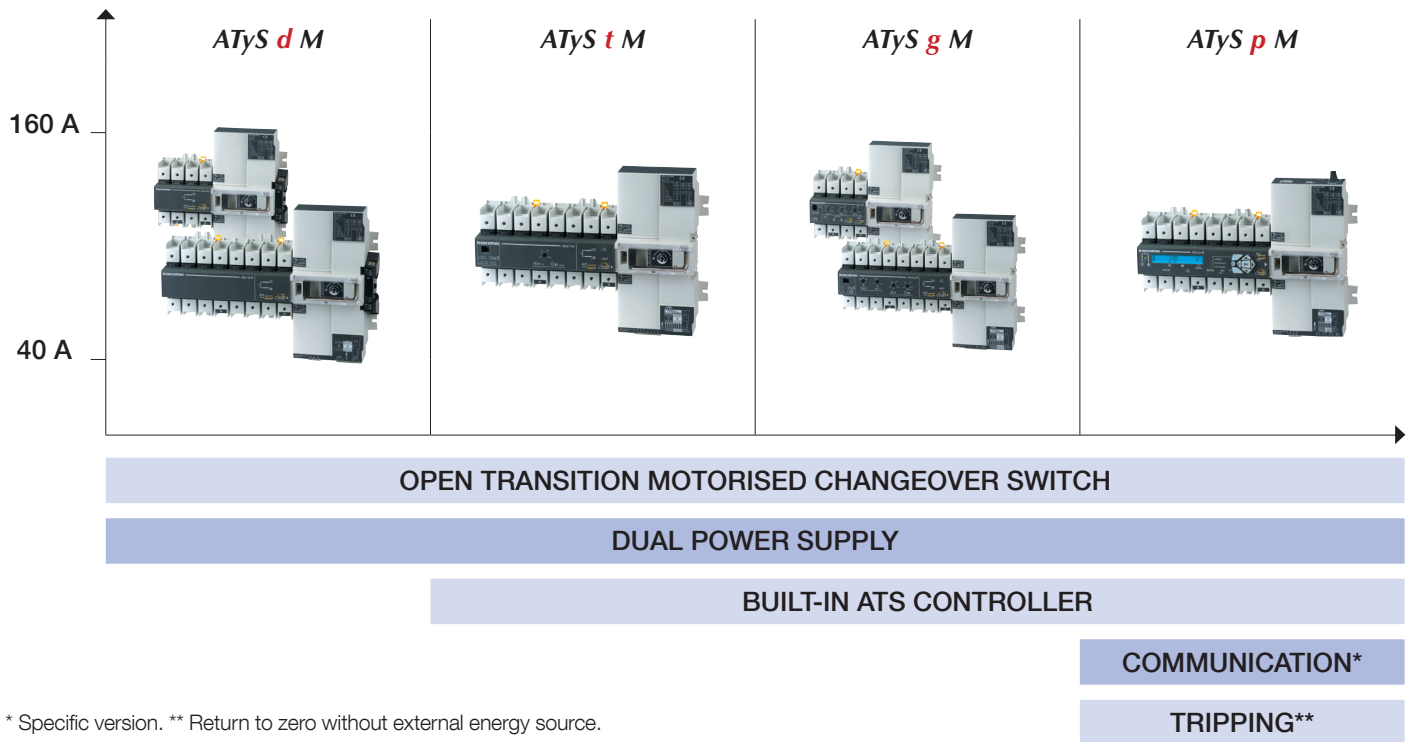

* Specific version. ** Return to zero without external energy source.

A product for virtually all power changeover applications from 40 to 160 A

- ▶ Network/Genset
- ▶ Genset/Genset
- ▶ Network/Network

Applications with an External ATS Control

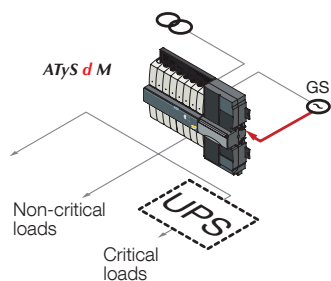

- ▶ Network/Network
- Building applications

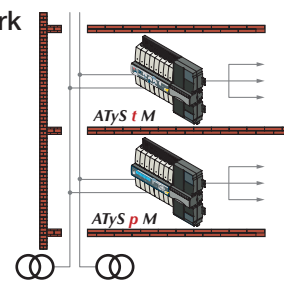

- ▶ Network/Genset
- Genset Applications for Standby Power

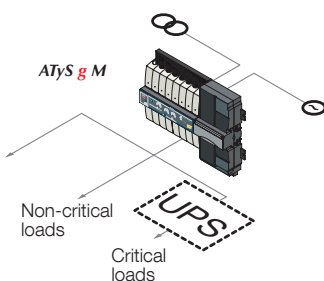

- ▶ Network/Genset
- ▶ Network/Network

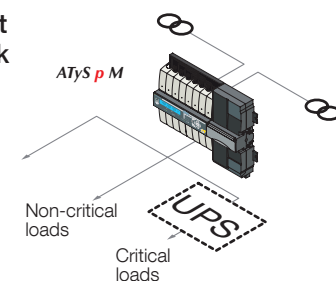

2.2.1. Selection guide

Six ratings 40/63/80/100/125/160 A

	<i>ATyS d M</i>	<i>ATyS t M</i>	<i>ATyS g M</i>	<i>ATyS p M</i>
APPLICATIONS				
Normal/Backup without automatic controller	•			
Normal/Backup with built-in automatic controller		•	•	•
Stable positions	•	•	•	•
Load changeover	•			
FUNCTIONS				
POWER SUPPLY				
External	•			
Integrated		•	•	•
OPERATION				
Backup manual operation of the 3 positions	•	•	•	•
Electrical (dry contact) control of positions I, 0 and II	•			•*
Automatic control of positions I, 0 and II		•	•	•
Return to 0 position feature upon loss of source				•
MONITORING				
3 voltages on networks I and II		•	•	•
Frequency on networks I and II		•	•	•
Phase rotation on networks I and II				•
Asymmetry of networks I and II				•
AUTOMATIC CONTROLLER CONFIGURATION				
By potentiometer and micro-switch		•	•	
By screen + keyboard				•
V _n , F _n , V threshold, F threshold		•	•	•
Driving with or without priority		•	•	•
Adjustable operating timers		•	•	•
Preset configuration				
Control type (impulse or switch/contactor)	•			
DISPLAY				
Position, fully visualised breaking	•	•	•	•
LED: source status, automatic mode, fault LED		•	•	•
LED: switch positions, supply, tests, control				•
V, F, timers, number of operations, last event				•
REMOTE CONTROL				
Outputs				
Generator start/ stop order			•	•
Product availability (not fault and not manual mode)			•	•*
Source available		•		•*
Programmable output (source, availability, fault)				•*
Inputs				
Test on load			•	•*
Retransfer			•	•*
Automatic mode inhibit		•	•	•*
Position O order		•		•*
Priority		•	•	•
Other programmable inputs (test off-load, position control, etc.)				•*
Remote control				
Human/Machine Interface (D10 and D20)				•
RS485 communication (MODBUS)				•**

* 3 inputs/3 outputs (programmable).

** Product reference is different: communication by RS485 connection (MODBUS) allows up to 31 ATyS M to be connected to a PC or a PLC over 1500 m.

3. QUICK START

3.1. Quick Start ATyS g M (2P)



QUICK START EN 40 - 160A (2P)

ATyS g M

Automatic
Transfer Switching Equipment

Preliminary operations

Check the following upon delivery and after removal of the packaging:

- Packaging and contents are in good condition.
- The product reference corresponds to the order.
- Contents should include:
Qty 1 x ATyS M
Qty 1 x Emergency handle extension ROD
Qty 1 x Set of terminals
Quick Start instruction sheet

Warning

⚠ Risk of electrocution, burns or injury to persons and / or damage to equipment.

This Quick Start is intended for personnel trained in the installation and commissioning of this product. For further details refer to the product instruction manual available on the SOCOMEC website.

- This product must always be installed and commissioned by qualified and approved personnel.
- Maintenance and servicing operations should be performed by trained and authorised personnel.
- Do not handle any control or power cables connected to the product when voltage may be, or may become present on the product, directly through the mains or indirectly through external circuits.
- Always use an appropriate voltage detection device to confirm the absence of voltage.
- Ensure that no metal objects are allowed to fall in the cabinet (risk of electrical arcing).

Failure to observe good engineering practises as well as to follow these safety instructions may expose the user and others to serious injury or death.

⚠ Risk of damaging the device

- In case the product is dropped or damaged in any way it is recommended to replace the complete product.

Accessories

- Bridging bars and 125A or 160A.
- Control voltage transformer (400Vac -> 230Vac).
- Voltage sense and power supply TAP.
- Terminal shrouds.
- Additional aux contact block.
- Polycarbonate enclosure.
- Polycarbonate extension box.
- Power Connection Terminals.
- Sealable cover.



www.socomec.com
www.socomec.com/operating-instructions
To download, brochures, catalogues and technical manuals.

Printing informations: 1 color Black. White paper 90g/m².
Printing size: 420x297. Final size 210x297. This page visible first.
A separate sheet for each language.

CORPORATE HQ CONTACT:
SOCOMECSAS, 1-4 RUE DE WESTHOUSE, 67235 BENFELD, FRANCE



Non contractual document.
Subject to change without notice.

Installation and Commissioning

STEP 1
Cabinet / Back
Plate Installation

STEP 2
Connecting the
POWER section

STEP 3
CONTROL /
AUX POWER
terminal
connections

STEP 4
CHECK

STEP 5
Programming

STEP 6A
Automatic Operation

STEP 6B
Emergency Manual
Operation

STEP 6C
Padlocking



STEP 3

CONTROL / AUX POWER Terminals and wiring

Type	Terminal no.	Application	Status of the contact	Description	Output characteristics	Recommended connection cross-section
Inputs	I1: 207 / 208	Network/Network		With priority	Dry potential free contact	0.5 to 2.5 mm ² (rigid) 0.5 to 1.5 mm ² (stranded)
				Without priority		
		Network-Genset.		Automatic retransfer		
				Manual Retransfer		
	I1: 207 / 209	Network/Network		Source priority 1	Dry potential free contact	
				Source priority 2		
Network-Genset.			Stop the test on load			
I3: 207 / 210	Network-Network or Network-Generating set		AUTO mode	Dry potential free contact		
			Automatic mode inhibition			
Outputs	O1: 63 / 64	Network-Network or Network-Generating set		Product not available : - Manual mode - Command default - Electronic default - No source	Resistive load 2A 30 Vdc 0.5A 230Vac Pmax : 60W or 125VA Umax : 30Vdc or 230Vac	
				Product available		
	O2: 73 / 74	Network-Genset.		No start command genset	Resistive load 2A 30 Vdc 0.5A 230Vac Pmax : 60W or 125VA Umax : 30Vdc or 230Vac	
				Generating set starting		

STEP 1

Installation

Caution: Ensure that the product is installed on a flat rigid surface.

Recommended orientation

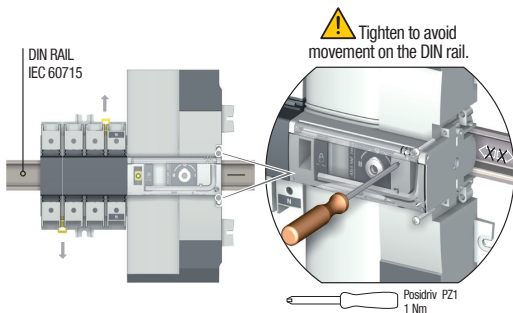
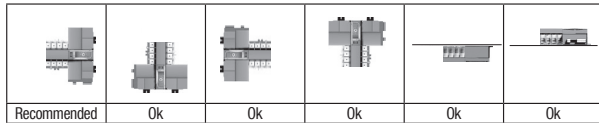

Posidriv PZ1
1 Nm

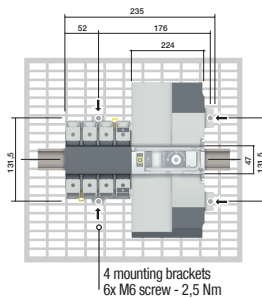
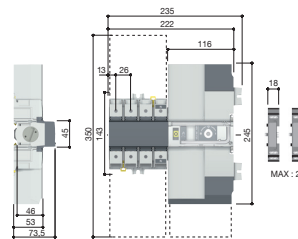

Padlocking configuration

The ATyS M is delivered with padlocking configured to the 0 position.

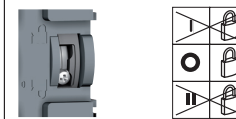

To allow padlocking in all positions (I - 0 - II), configure the ATyS M as follows before installation. (Screw is located at the back of the product).

STEP 2

Power Terminal Connections

It is essential to tighten all used terminals, with cables and/or bridging bars, before use.

Load side bridging bar.
125A: 1309 2006
160A: 1309 2016



Source supply side

Hexagonal Metric
Allen size 4
5,0 Nm

10 to 70 mm²
[15mm]



Voltage taps provide 2x ≤ 1.5mm² connections. They can be fitted in any terminals on the source supply side. Do not use on the load side when equipped with a bridging bar.

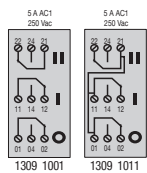
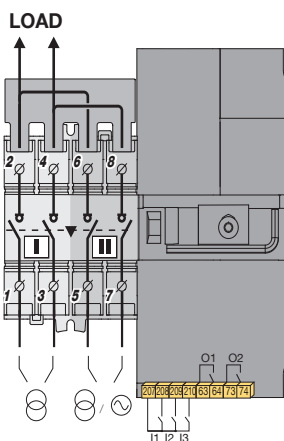
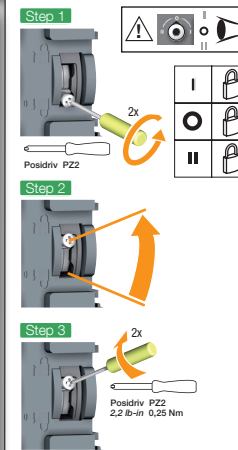
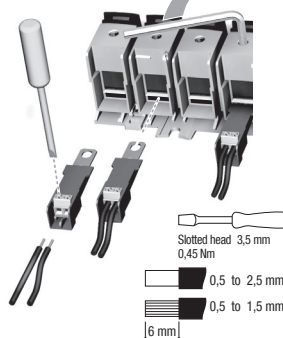

Ensure that the product is in Manual Mode (front cover open).

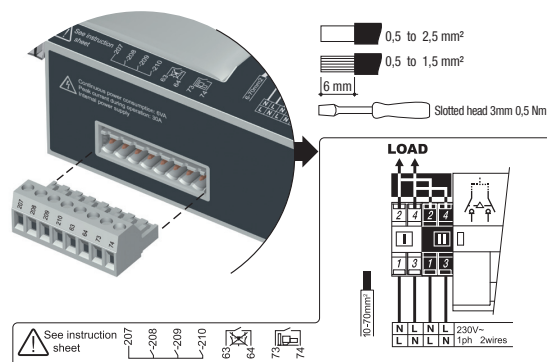

Auxiliary contacts: Fitting of auxiliary contacts: 1309 1001 or 1309 1011
To fit an AC, the switch must first be put in position 0. An auxiliary contact module comprises: one NO/NC changeover contact for each position (I-0-II). To install use the long screws supplied with the module.

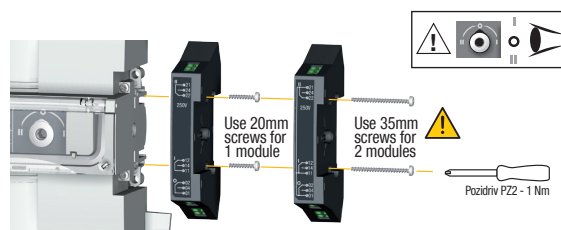

Type	Terminal no.	Status of the contact	Description	Output characteristics	Recommended connection cross-section
Auxiliary contact block 1309 1001	11/12/14	11 — 14 12	Changeover switch in position I	250V AC 5A AC1 30 Vdc 5 A	0,5 to 2,5 mm ² (rigid)
	21/22/24	21 — 24 22	Changeover switch in position II	250V AC 5A AC1 30 Vdc 5 A	
	01/02/04	01 — 04 02	Changeover switch in position 0	250V AC 5A AC1 30 Vdc 5 A	
Auxiliary contact block 1309 1011	11/12/14	11 — 14 12	Changeover switch in position I	250V AC 5A AC1 30 Vdc 5 A	0,5 to 1,5 mm ² (stranded)
	21/22/24	21 — 24 22	Changeover switch in position II	250V AC 5A AC1 30 Vdc 5 A	
	01/02/04	01 — 04 02	Changeover switch in position 0	250V AC 5A AC1 30 Vdc 5 A	

STEP 4

Check

Whilst in manual mode, check the wiring and if ok power up the product.



STEP 5

Programming

The LED signalling and operation is only active when the product supply is available. To set the dip switches, it is necessary to open the Auto/Manual cover. Commissioning must always result in having at least 1 LED source available on. (Therefore, the voltage and frequency must be within the defined thresholds).

⚠ Any action on the potentiometers will change the settings, even when the cover is closed.

A Dip switch settings



Stop in 0 position: E-F

- E: No stop in 0 position
- F: 2s stop in 0 position

Type of application: G-H

- G: Network - Genset
- H: Network - Network

B Hysteresis settings

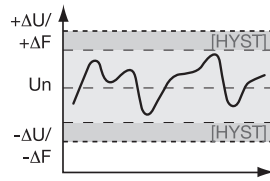

HYST: 20 %ΔU/F
ΔU: 5-20%
ΔF: 3-10%

C Timer settings

Loss of priority source timer

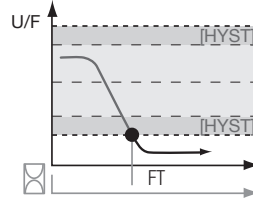

FT: 0-60 sec.

Return of priority source timer

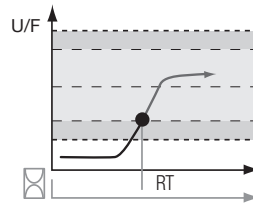

RT: 0-30 min.

D Source supply voltage and frequency Auto-Configuration

Ensure that the supply voltage is available and within the following limits:

Un: 176-288VAC
Fn: 45-65Hz

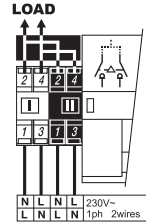

Press PROG for ≥ 2s



LED state	Auto Conf result	Action
Steady ON	OK	Ready
Blinking	Not OK	Go back to step 4

E LED info

Source availability LED

Source	LED ON	LED OFF	LED blinking
I	Source 1 available	Source 1 not available or out of range	- a timer is counting down - test mode
II	Source 2 available	Source 2 not available or out of range	- a timer is counting down

Fault and state of the product LED's

	LED ON	LED OFF	LED blinking
⚠	Fault	Product OK or S1-S2 not available	Please wait
AUT	Auto mode	Manual mode	Manual retransfer

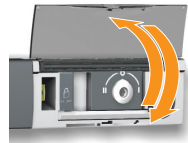

Fault reset

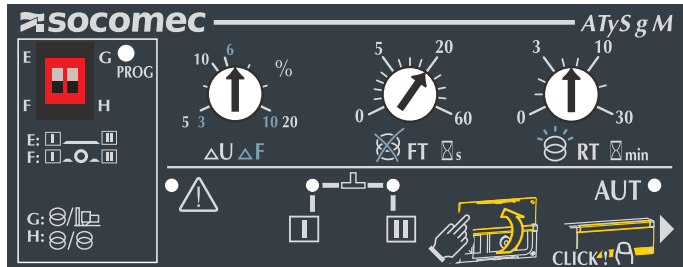

STEP 6A

Automatic operation

Close the front cover as shown to put the product into automatic mode.



STEP 6B

Manual operation

- Open the front cover as shown to put into manual mode.
- Use the handle situated in the front panel under the cover to operate the transfer switch.
- Check the changeover switch position on the indicator before operating.

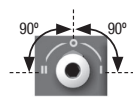

To simplify operation use the handle with the extension provided.

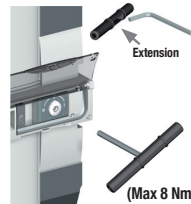

(Max 8 Nm)

STEP 6C

Padlocking mode

- In order to padlock put the product in manual mode.
- Pull the locking mechanism and insert a padlock as shown.
- As standard padlocking in the 0 position. Configurable to I-0-II (see step 1).

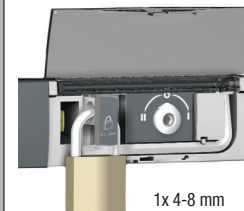

1x 4-8 mm

3.2. Quick Start ATyS g M (4P)

socomec
Innovative Power Solutions

QUICK START EN 40 - 160A (4P)

ATyS g M

Automatic
Transfer Switching Equipment

Preliminary operations

Check the following upon delivery and after removal of the packaging:

- Packaging and contents are in good condition.
- The product reference corresponds to the order.
- Contents should include:
 - Qty 1 x ATyS M
 - Qty 1 x Emergency handle extension ROD
 - Qty 1 x Set of terminals
 - Quick Start instruction sheet

Warning

⚠ Risk of electrocution, burns or injury to persons and / or damage to equipment.

This Quick Start is intended for personnel trained in the installation and commissioning of this product. For further details refer to the product instruction manual available on the SOCOMECE website.

- This product must always be installed and commissioned by qualified and approved personnel.
- Maintenance and servicing operations should be performed by trained and authorised personnel.
- Do not handle any control or power cables connected to the product when voltage may be, or may become present on the product, directly through the mains or indirectly through external circuits.
- Always use an appropriate voltage detection device to confirm the absence of voltage.
- Ensure that no metal objects are allowed to fall in the cabinet (risk of electrical arcing).

Failure to observe good engineering practises as well as to follow these safety instructions may expose the user and others to serious injury or death.

⚠ Risk of damaging the device

- In case the product is dropped or damaged in any way it is recommended to replace the complete product.

Accessories

- Bridging bars and 125A or 160A.
- Control voltage transformer (400Vac -> 230Vac).
- Voltage sense and power supply TAP.
- Terminal shrouds.
- Additional aux contact block.
- Polycarbonate enclosure.
- Polycarbonate extension box.
- Power Connection Terminals.
- Sealable cover.



www.socomec.com
www.socomec.com/operating-instructions
To download, brochures, catalogues and technical manuals.

Printing informations: 1 color Black. White paper 90g/m².
Printing size: 420x297. Final size 210x297. This page visible first.
A separate sheet for each language.

CORPORATE HQ CONTACT:
SOCOMECE SAS, 1-4 RUE DE WESTHOUSE, 67235 BENFELD, FRANCE



542932E



Non contractual document.
Subject to change without notice.

Installation and Commissioning

STEP 1
Cabinet / Back Plate Installation

STEP 2
Connecting the POWER section

STEP 3
CONTROL / AUX POWER terminal connections

STEP 4
CHECK

STEP 5
Programming

STEP 6A
Automatic Operation

STEP 6B
Emergency Manual Operation

STEP 6C
Padlocking

STEP 3

CONTROL / AUX POWER Terminals and wiring

Type	Terminal no.	Application	Status of the contact	Description	Output characteristics	Recommended connection cross-section
Inputs	I1: 207 / 208	Network/Network		With priority	Dry potential free contact	0.5 to 2.5 mm ² (rigid) 0.5 to 1.5 mm ² (stranded)
				Without priority		
		Network-Genset.		Automatic retransfer		
				Manual Retransfer		
	I1: 207 / 209	Network/Network		Source priority 1	Dry potential free contact	
				Source priority 2		
Network-Genset.			Stop the test on load			
I3: 207 / 210	Network-Network or Network-Generating set		AUTO mode	Dry potential free contact		
			Automatic mode inhibition			
Outputs	O1: 63 / 64	Network-Network or Network-Generating set		Product not available : - Manual mode - Command default - Electronic default - No source	Resistive load 2A 30 Vdc 0.5A 230Vac Pmax: 60W or 125VA Umax: 30Vdc or 230Vac	
				Product available		
	O2: 73 / 74	Network-Genset.		No start command genset	Resistive load 2A 30 Vdc 0.5A 230Vac Pmax: 60W or 125VA Umax: 30Vdc or 230Vac	
				Generating set starting		

STEP 1

Installation

Caution: Ensure that the product is installed on a flat rigid surface.

Recommended orientation

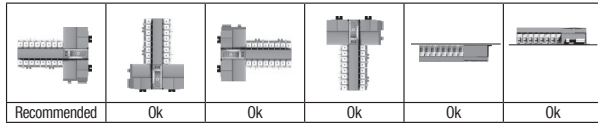

DIN RAIL
IEC 60715

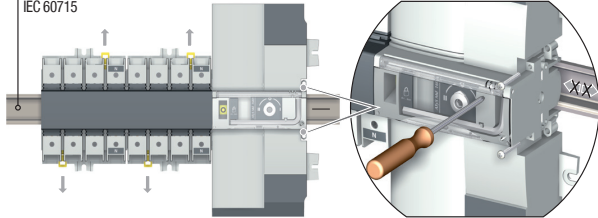

Tighten to avoid movement on the DIN rail.

Posidriv PZ1
1 Nm

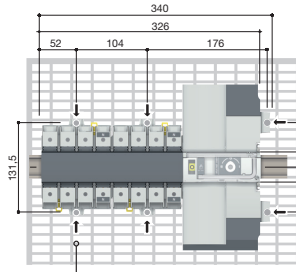
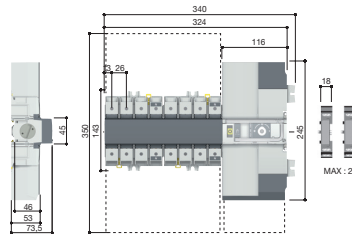

Padlocking configuration

The ATYS M is delivered with padlocking configured to the 0 position.

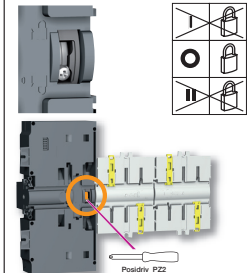

To allow padlocking in all positions (I - 0 - II), configure the ATYS M as follows before installation. (Screw is located at the back of the product).

STEP 2

Power Terminal Connections

It is essential to tighten all used terminals, with cables and/or bridging bars, before use.



Source supply side

Load side bridging bar.
125A: 1309 4006
160A: 1309 4016

Hexagonal Metric
Allen size 4
5,0 Nm

10 to 70 mm²
15mm

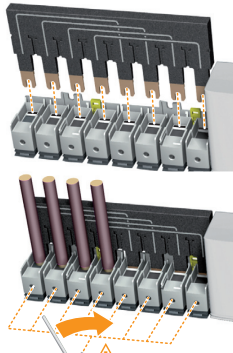

X8

Voltage taps provide 2x ≤ 1.5mm² connections. They can be fitted in any terminals on the source supply side. Do not use on the load side when equipped with a bridging bar.

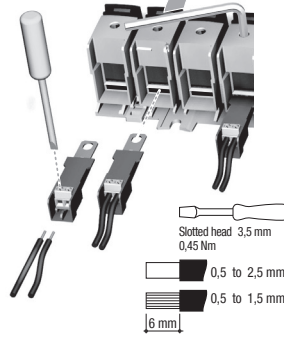

Slotted head 3,5 mm
0,45 Nm

0,5 to 2,5 mm²

0,5 to 1,5 mm²

6 mm

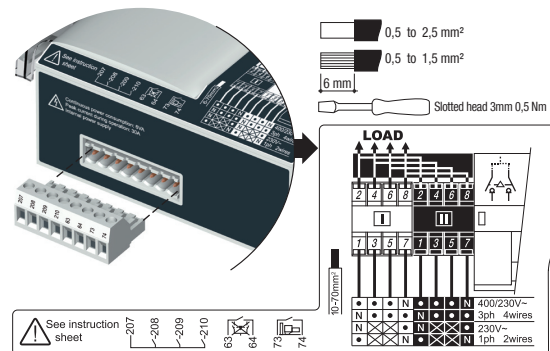
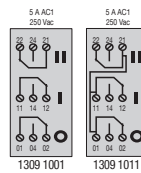
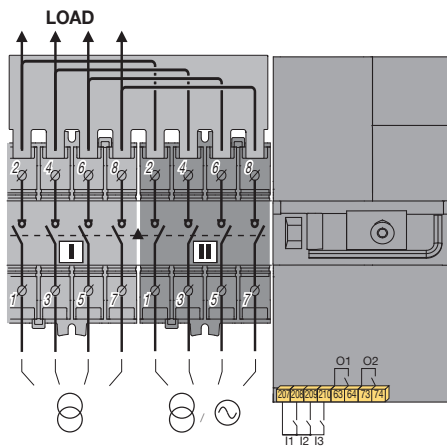
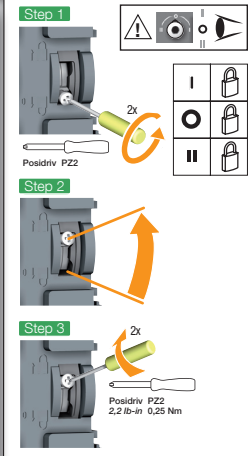

See instruction sheet
207 208 209 210 63 64 73 74

Ensure that the product is in Manual Mode (front cover open).

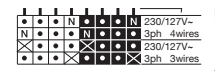

Type	Terminal no.	Status of the contact	Description	Output characteristics	Recommended connection cross-section
Auxiliary contact block 1309 1001	11/12/14	11 — 14 12	Changeover switch in position I	250V AC 5A AC1 30 Vdc 5 A	0.5 to 2.5 mm ² (rigid)
	21/22/24	21 — 24 22	Changeover switch in position II	250V AC 5A AC1 30 Vdc 5 A	
	01/02/04	01 — 04 02	Changeover switch in position 0	250V AC 5A AC1 30 Vdc 5 A	
Auxiliary contact block 1309 1011	11/12/14	11 — 14 12	Changeover switch in position I	250V AC 5A AC1 30 Vdc 5 A	0.5 to 1.5 mm ² (stranded)
	21/22/24	21 — 24 22	Changeover switch in position II	250V AC 5A AC1 30 Vdc 5 A	
	01/02/04	01 — 04 02	Changeover switch in position 0	250V AC 5A AC1 30 Vdc 5 A	

Auxiliary contacts: Fitting of auxiliary contacts: 1309 1001 or 1309 1011

To fit an AC, the switch must first be put in position 0. An auxiliary contact module comprises: one NO/NC changeover contact for each position (I-0-II). To install use the long screws supplied with the module.

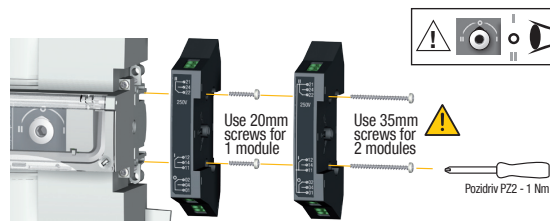

STEP 4

Check

Whilst in manual mode, check the wiring and if ok power up the product.



STEP 5

Programming

The LED signalling and operation is only active when the product supply is available. To set the dip switches, it is necessary to open the Auto/Manual cover. Commissioning must always result in having at least 1 LED source available on. (Therefore, the voltage and frequency must be within the defined thresholds).

⚠ Any action on the potentiometers will change the settings, even when the cover is closed.

A Dip switch settings



Type of network: A-B

- A: 3P
- B: 1P

Frequency: C-D

- C: 50 Hz
- D: 60 Hz

Stop in 0 position: E-F

- E: No stop in 0 position
- F: 2s stop in 0 position

Type of application: G-H

- G: Network - Genset
- H: Network - Network

B Source voltage supply configuration

127/230 Vac version



Un (P-P):
208-240 Vac
Un (P-N):
120-138 Vac

230/400 Vac version



Un (P-P):
380-420 Vac
Un (P-N):
220-240 Vac

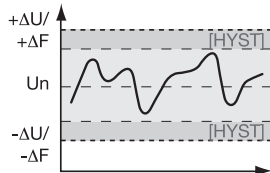

HYST: 20 % Δ U/F
 Δ U: 5-20%
 Δ F: 3-10%

C Timer settings

Loss of priority source timer

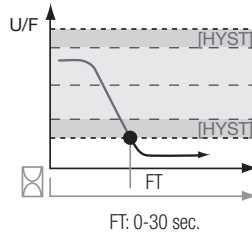

Return of priority source timer

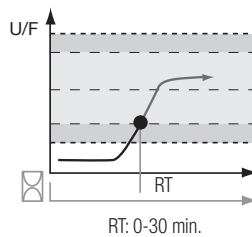

D Led info

Source availability LED

Source	LED ON	LED OFF	LED blinking
I	Source 1 available	Source 1 missing or out of range	- a timer is counting down - test mode
II	Source 2 available	Source 2 missing or out of range	- a timer is counting down

Fault and state of the product Leds

	LED ON	LED OFF	LED blinking
⚠	Fault	Product OK	Wait
AUT	Auto mode	Manual mode	Manual retransfer



Fault reset

socomec

ATySg M

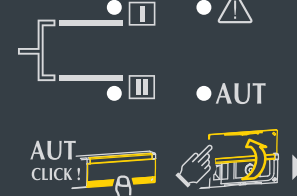
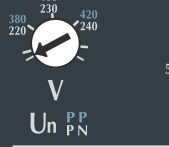

STEP 6A

Automatic operation

Close the front cover as shown to put the product into automatic mode.



AUT
CLICK!

STEP 6B

Manual operation

- Open the front cover as shown to put into manual mode.
- Use the handle situated in the front panel under the cover to operate the transfer switch.
- Check the changeover switch position on the indicator before operating.

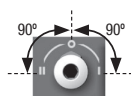

To simplify operation use the handle with the extension provided.

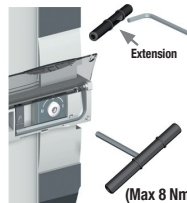

STEP 6C

Padlocking mode

- In order to padlock put the product in manual mode.
- Pull the locking mechanism and insert a padlock as shown.
- As standard padlocking in the 0 position. Configurable to I-0-II (see step 1).

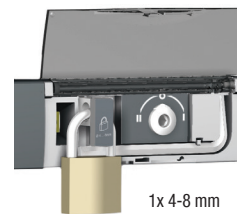

1x 4-8 mm

4. ATYS G M VERSIONS

The ATYS g M is available as 2P or 4P with the possibility of being used on virtually any automatic open transition type of application.

Measurement accuracy: Frequency: 1 % - Voltage: 1 %

4.1. Product presentation

This quick-acting transfer switch incorporates:

1. 2 mechanically interlocked switches.
2. A quick-acting electric control unit enabling electric or manual system operation.
3. Electrical specifications compliant with product standards, and a version identification.
4. Changeover switch wiring identification.
5. Control connections.

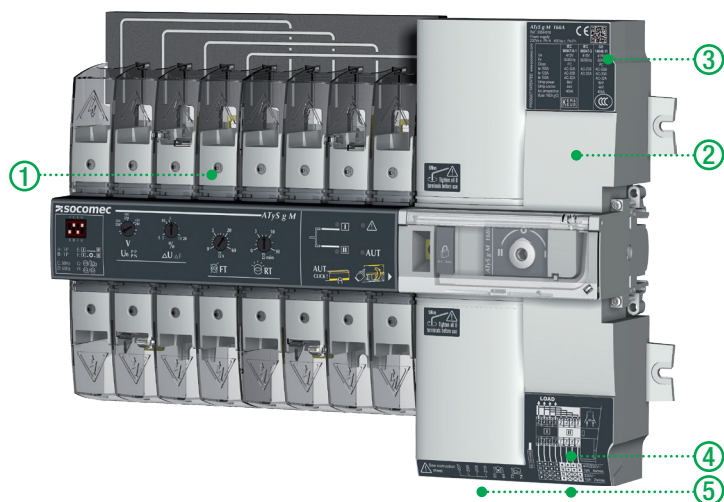
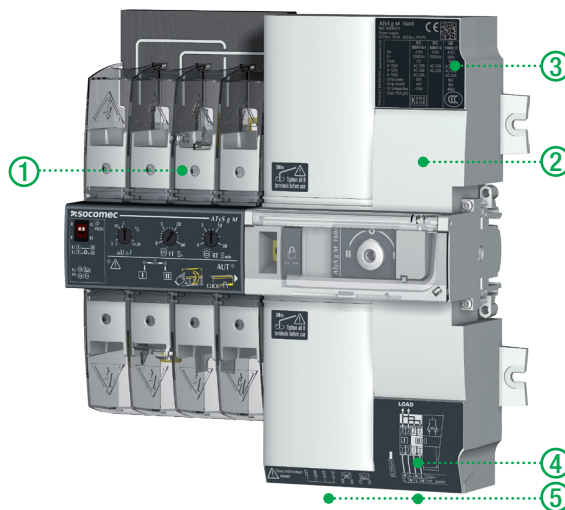

CAUTION ! Ensure that the load is connected to the top of the switch with the motorisation on the right hand side as shown.

4.2. Specifications and advantages

1 - Power section:

A fully integrated and interlocked transfer switch, with high electrical performance offering microprocessor control and monitoring.

2 - Operation:

A flexible operating mechanism enabling quick motorised transfer in automatic mode or locally in manual mode for emergency operations. Features a locking device to ensure (in position zero) a secured isolation of the load (padlocked).









4.3. Supply types

The power supply of ATYS g M is required to be 220 VAC -20% to 240VAC +20% at a frequency of 50/60 Hz and has been developed so as to meet most network configurations.

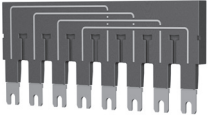
Product's working ranges:

	230 / 400 VAC Version		127 / 230 VAC Version		230 VAC Version	
	Umin	Umax	Umin	Umax	Umin	Umax
Ph-N	176	288	176	288	176	288
Ph-Ph	305	498	305	498	/	/

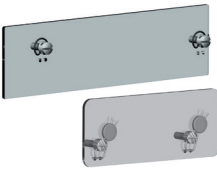
5. OPTIONAL ACCESSORIES

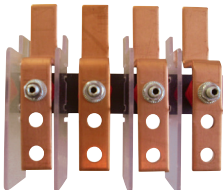
Auxiliary contacts	Each product can take up to 2 auxiliary contact blocks. Each accessory integrates 1 NOC auxiliary contact (for each position I, O and II) 1309 1001 or NONC for 1309 1011. Characteristics: 250 VAC / 5 A maximum. The ATyS d M includes 1x aux contact reference 1309 1001 as standard.		Ref. : 1309 1001 Ref. : 1309 1011
Bridging bars	To provide a common point on the outgoing side of the switch (load side).		Single phase product: Rating ≤ 125A: 1309 2006 Rating 160A: 1309 2016
			Three phase product: Rating ≤ 125A: 1309 4006 Rating 160A: 1309 4016
Terminal shrouds	Protection against direct contact with terminals or connecting parts. Other features: Perforations allowing remote thermographic inspection without removal. Possibility of sealing.		Ref. : 2294 4016 2 parts/ref.
Enclosure	Fully dedicated to ATyS M use, this polycarbonate enclosure provides easy access to a compact, enclosed transfer switch (HxWxD: 385x385x193mm).		Ref. : 1309 9006
Extension unit	Combined with the polycarbonate enclosure, the extension box creates extra space for routing cables with a larger diameter.		Ref. : 1309 9007
Single phase residential enclosure	Dedicated to the implementation of a single-phase ATyS M, it enables easy access to a compact power supply switching solution. 40-160A (HxWxD: 410x305x150mm). IP41		Ref. : 1309 9056
Sealable cover.	It prevents access to the configuration panel of the ATyS g M.		Three phases product: Ref. : 1359 0000 Single phase product: Ref. : 1359 2000
Auto-transformer	For use with ATyS M in 400 VAC three-phase applications without a distributed neutral. As the ATyS M has a 230Vac auxilliary power supply requirement. When no neutral connection is available this autotransformer (400/230 VAC, 400 VA) provides the 230 VAC required for the ATyS M to function.		Ref. : 1599 4121
Power connection terminals	The power connection terminals allow conversion of the cage terminals into bolt-on type connection terminals, enabling connection of up to two 35mm ² cables or one 70mm ² cable. Each power connection terminal is provided with separation screens.		Ref. : 1399 4017 For complete conversion, order 3 times the reference.

6. TECHNICAL DATA

RATINGS		40A	63 A	80 A	100 A	125 A	160 A
Frequencies		50/60 Hz	50/60 Hz	50/60 Hz	50/60 Hz	50/60 Hz	50/60 Hz
Thermal current I _{th} at 40 °C (A)		40	63	80	100	125	160
Thermal current I _{th} at 50 °C (A)		40	63	80	100	110*	125
Thermal current I _{th} at 60 °C (A)		40	50	63	80	100*	125
Thermal current I _{th} at 70 °C (A)		40	40	50	63	80*	100
Rated assigned insulation voltage U _i (V) (Power circuit)		800	800	800	800	800	800
Rated impulse withstand voltage U _{imp} (kV) (power circuit)		6	6	6	6	6	6
Rated insulation voltage U _i (V) (control circuit)		300	300	300	300	300	300
Rated impulse withstand voltage U _{imp} (kV) (control circuit)		2.5	2.5	2.5	2.5	2.5	2.5
Rated operational currents (A) IEC 60947-3 at 415VAC at 40 °C	AC 21A / 21 B	40/40	63/63	80/80	100/100	125/125	160/160
	AC 22A / 22 B	40/40	63/63	80/80	100/100	125/125	125/160
	AC 23A / 23 B	40/40	63/63	80/80	100/100	125/125	125/160
Rated operational currents (A) IEC 60947-6-1 415Vac at 40 °C	AC 33B / AC32B **AC 33iB	40/40	63/63	80/80	100/100	125/125	125**/160
Fuse protected short-circuit withstand if using gG DIN fuses	Fuse protected short-circuit withstand (kA eff)	50	50	50	50	50	40
	Associated fuses (gG DIN)	40	63	80	100	125	160
Short-circuit capacity	Rated short-term withstand current: I _{cw} 1s (kA eff)	4	4	4	4	4	4
	Rated short-term withstand current: I _{cw} 30ms (kA eff)	10	10	10	10	10	10
Switching time at I _n excluding loss of supply sensing time and excluding any delay timers applicable.	I-II or II-I (ms)	180	180	180	180	180	180
	Duration of "electrical blackout" at U _n (ms)	90	90	90	90	90	90
	I-O / O-I / II-O / O-II (ms)	45	45	45	45	45	45
Consumption	Inrush current(A)	20	20	20	20	20	20
	Consumption in stabilised state (VA)	6	6	6	6	6	6
Mechanical characteristics	Number of changeovers	10000	10000	10000	10000	10000	10000
Connection cross-section (⚠ not compatible with aluminium cables)	Minimum size (Cu mm ²), flexible and rigid	10	10	10	10	10	10
	Maximum size (Cu mm ²), flexible and rigid	70	70	70	70	70	70
Equipment class (According to IEC 60947-6-1)		PC	PC	PC	PC	PC	PC
EMC environment		A	A	A	A	A	A

* Possibility of reaching 125A with bigger connection cross-sections and use of the 160A bridging bar.

** AC 33iB 160A according to GB 14048.11.



This is a class A product. In a domestic environment, this product may cause radio interference in which case the user may be required to take adequate measures.

7. ENVIRONMENTAL CONDITIONS



Humidity

- 80 % humidity without condensation at 55 °C
- 95 % humidity without condensation at 40 °C



Temperature

- -20 +40 °C without de-rating
- 40 °C < t ≤ 70 °C with de-rating (see Technical Characteristics)



Altitude

- Up to 2000m

Correction factors:

	2 000 m < A ≤ 3 000 m	3 000 m < A ≤ 4 000 m
UE	0.95	0.80
le	0.85	0.85



Storage

- 1 year maximum
- Maximum storage temperature: +55 °C
- 80 % humidity without condensation at 55 °C



IP rating

- IP41 in the SOCOMEC polycarbonate modular enclosure see page page 25
- IP2x for non-enclosed modular product

Protection class: Class 1

8. PRODUCT INSTALLATION



Prior to installation of the product ensure that the padlocking setting screw (located at the back of the product) is configured as per your requirements.
For locking in Positions I, II and 0, refer to the following procedure.

8.1. Changing the padlocking configuration

To configure the locking in the 3 positions:
STEP1: loosen the screw at the back of the product as shown below.
STEP2: slide the screw upwards.
STEP3: tighten the screw in the top position as shown.

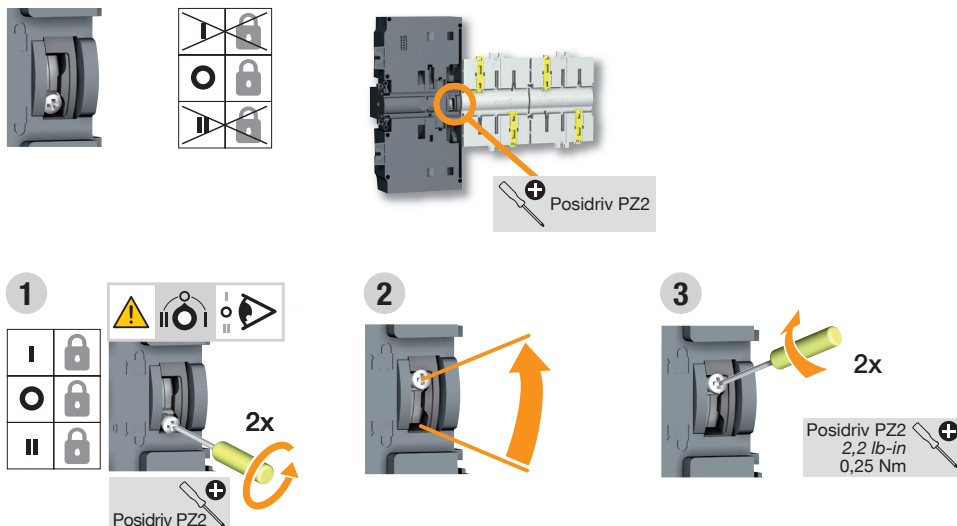

8.2. Recommended orientation

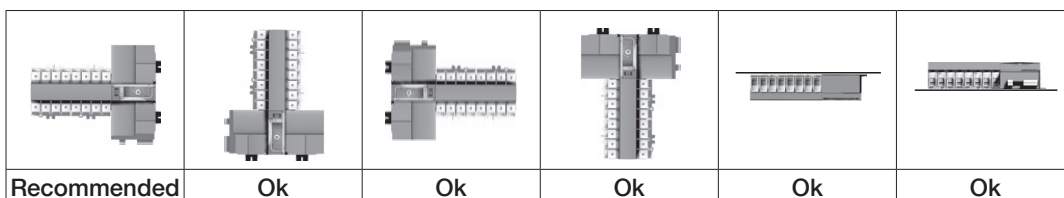

8.3. Dimensions of the single phase

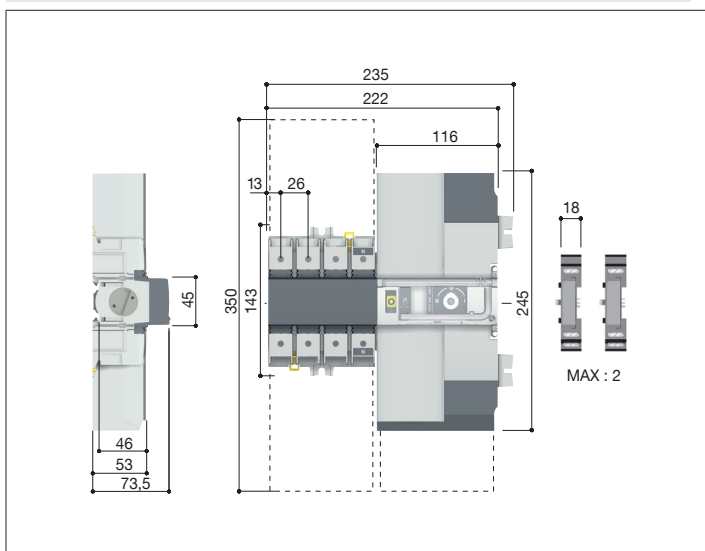

8.4. Back plate mounted single phase

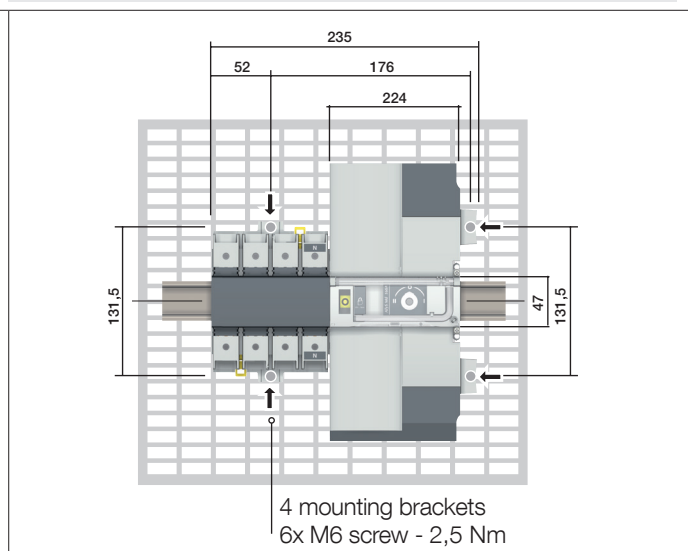

8.5. Dimensions of the three phase

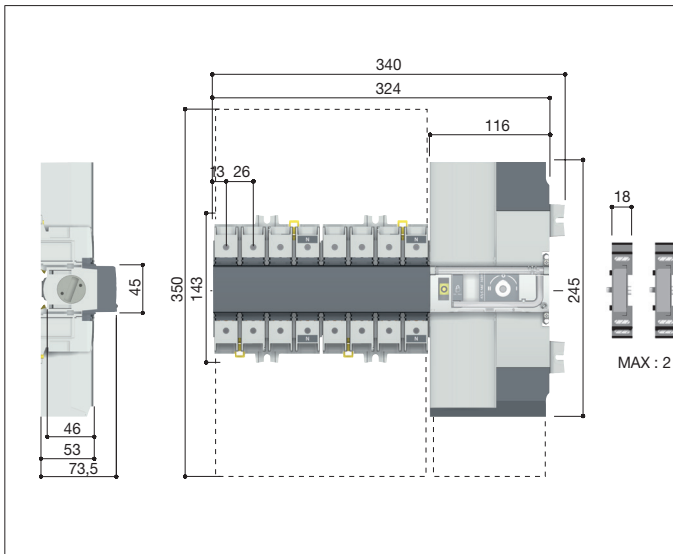

8.6. Back plate mounted three phase

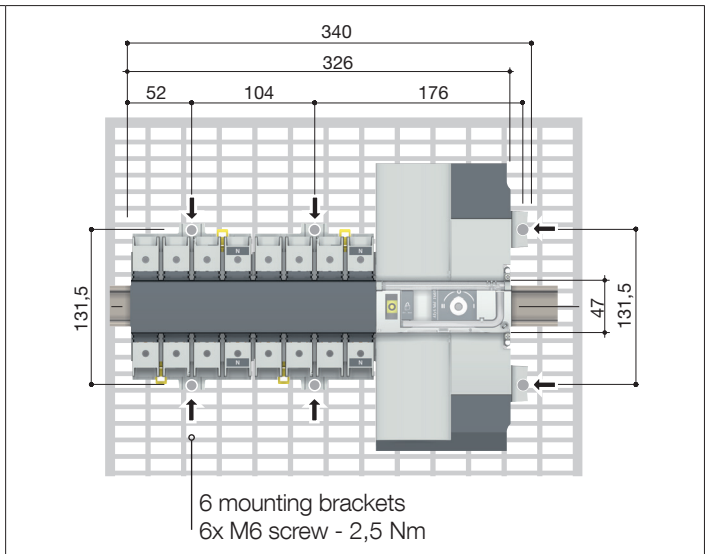

8.7. DIN rail mounted

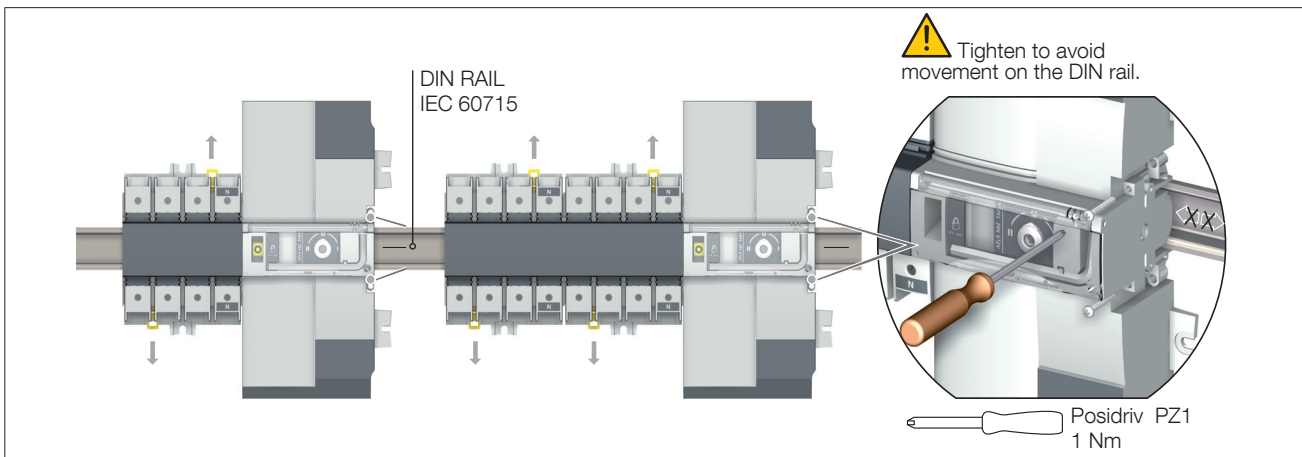

9. INSTALLATION OF OPTIONAL ACCESSORIES

9.1. Auxilliary contacts

Ref. 1309 1001 or ref. 1309 1011.

To fit an additional AC, the switch must first be put in the 0 position. An auxiliary contact module comprises: one NO/NC or NOC changeover contact for each position (I-0-II). To install use the screws supplied with the module. One module is factory fitted.

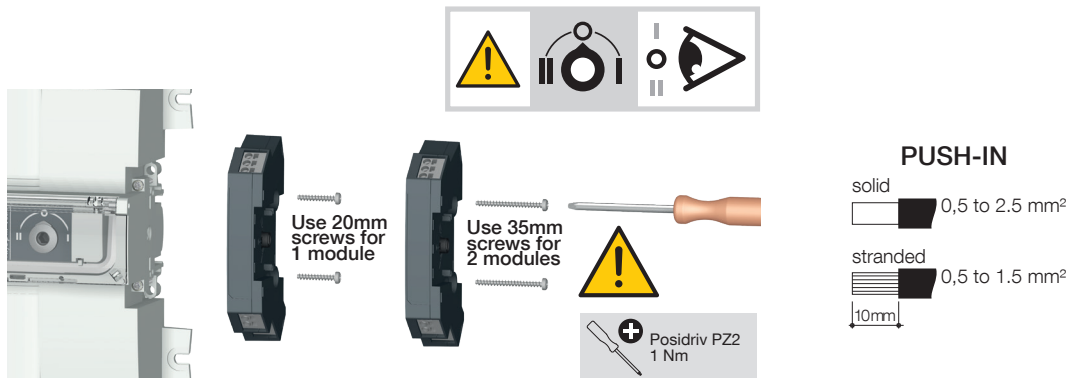

9.2. Voltage sensing and power supply tap

Ref. 1399 4006.

This provides 2 connection terminals for conductors with cross-section $\leq 1.5 \text{ mm}^2$.

The single pole terminals can be fitted in any of the terminal cages without reducing the cage connection capacity. 2 parts/ref. Do not use in case of use of the bridging bar.

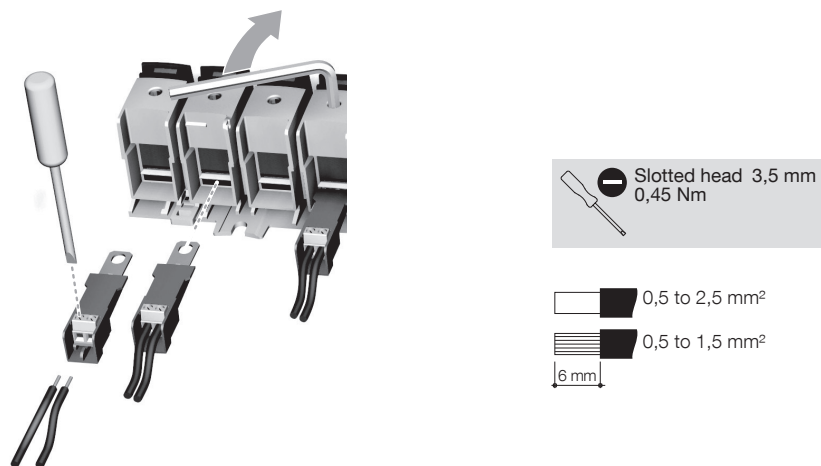

9.3. Bridging bars 2P

Ratings $\leq 125\text{A}$: ref. 1309 2006; 160A: ref. 1309 2016



Make sure that the bridging bar is fitted to the correct set of terminals. There are two references available: one for ratings up to 125A, and another for 160A rating.

9.4. Bridging bars 4P

Ratings $\leq 125\text{A}$: ref. 1309 4006; 160A : ref. 1309 4016

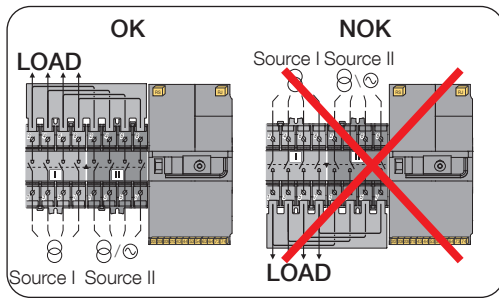

Bridging bar.
125A: 1309 4006
160A: 1309 4016

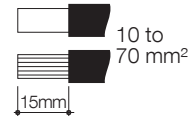
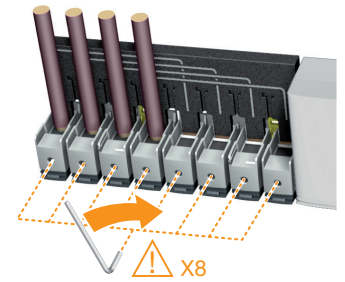
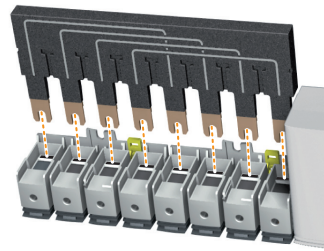

Make sure that the bridging bar is fitted to the correct set of terminals.
There are two references available: one for ratings up to 125A, and another for 160A rating.

9.5. Terminal shrouds

Ref. 2294 4016

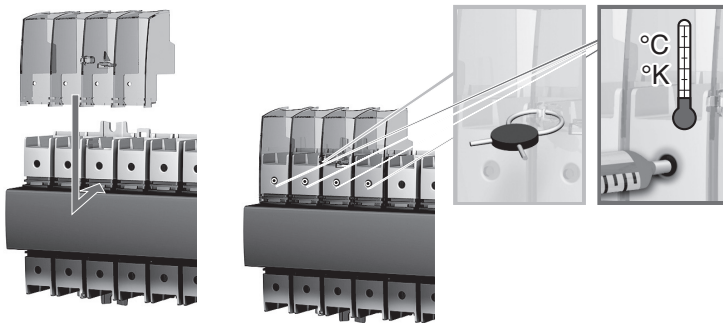

9.6. Sealable cover

Single phase: ref. 1359 2000; three phase: ref. 1359 0000

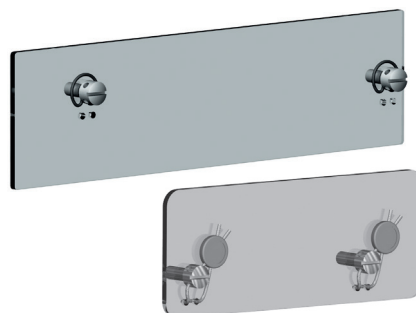

10. INSTALLING WITHIN THE ATYS M ENCLOSURE

10.1. Modular plastic enclosure

Ref. 1309 9056

Dimensions and mounting (for 2P ATyS M products only)

The enclosure must be wall-mounted using screws (not supplied). Recommended size: M6 50 mm (minimum).
Weight : between 8 and 10 kg, depending on the accessories.



Only 1 aux contact block may be installed when using this enclosure.

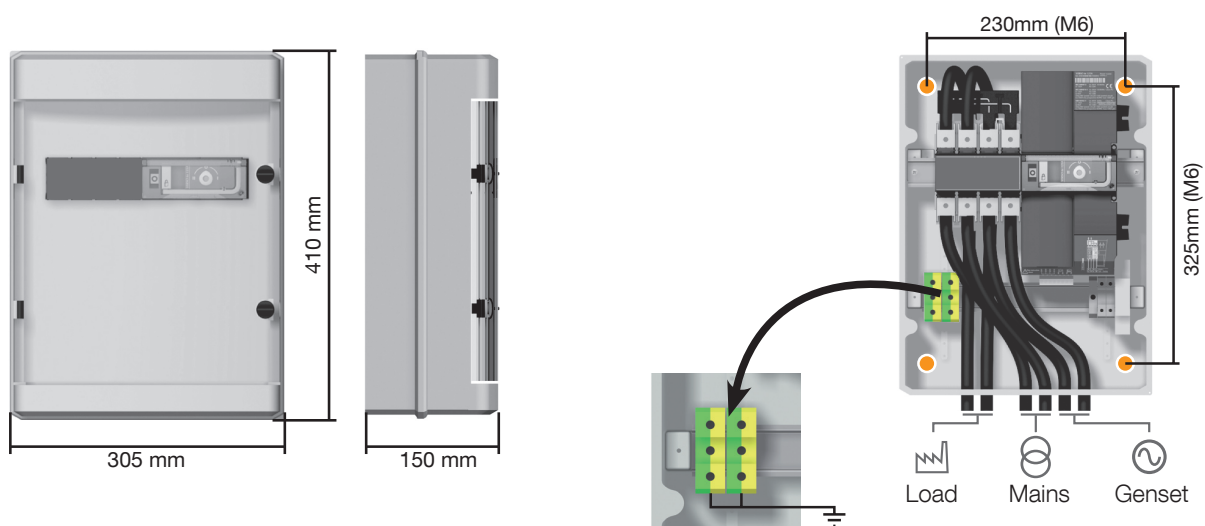

10.2. Polycarbonate enclosure

Ref. 1309 9006

Dimensions and mounting

The enclosure must be wall-mounted using screws (not supplied). Recommended size: M6 50 mm (minimum).
Weight: between 8 and 10 kg, depending on the accessories.



Only 1 aux contact block may be installed when using this enclosure.

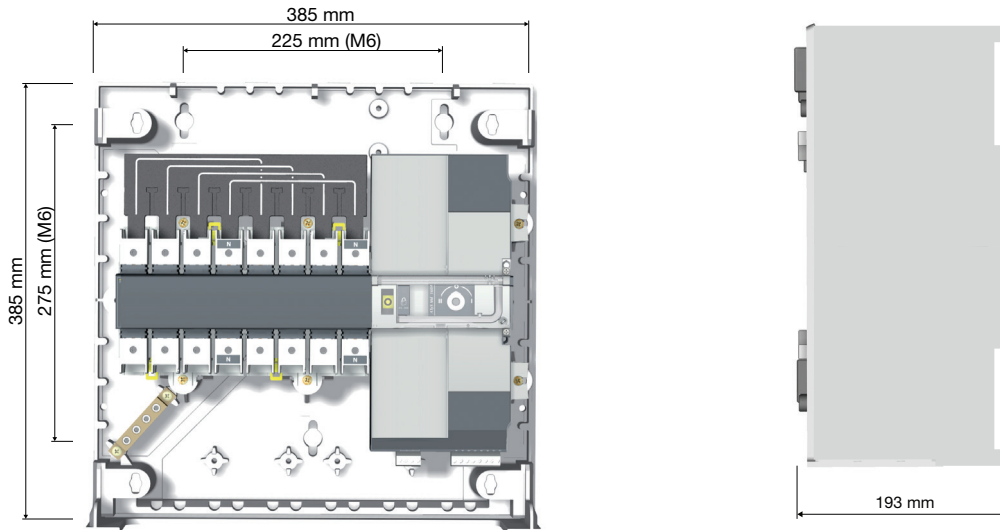

10.2.1. Wiring in a polycarbonate enclosure

Example: Neutral on the right

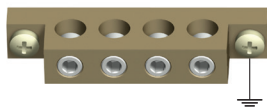

Max cable size 25 mm²

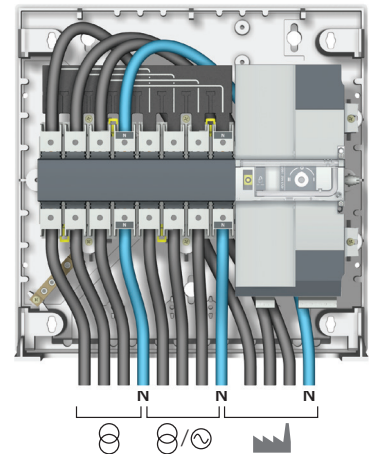

10.2.2. Extension unit

Ref. 1309 9007

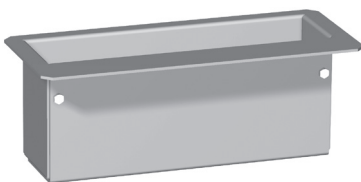

Enables you to allocate additional space to the polycarbonate enclosure (ref. 1309 9006).

11. CONNECTION OF THE POWER CIRCUITS

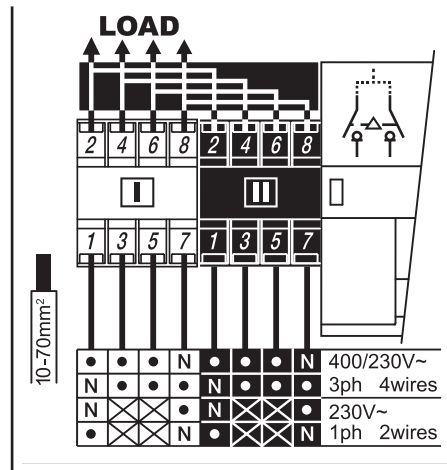
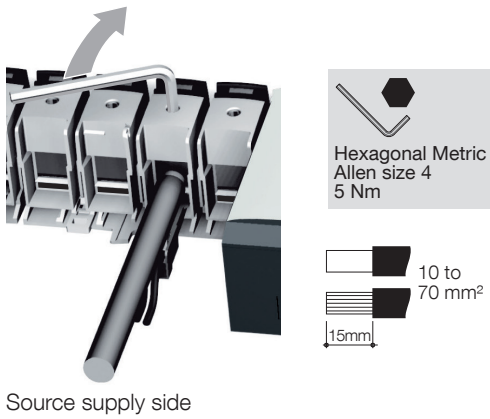

It is essential to tighten all used terminals, with cables and/or bridging bars, before use.

11.1. Ratings / cross-sections table of correspondence

	40 A	63 A	80 A	100 A	125 A	160 A
Min cable size recommended (mm ²)	10	16	25	35	50	50
**Max cable size recommended (mm ²)	50	50	50	50	70*	70*

*With extension unit.

** Maximum cable size for rigid cable is 50 mm². For larger terminations use the power connection terminals ref. 1399 4017.



Not compatible with aluminium cables

11.2. Parallel pole set-up for a 4P device used in single phase

Rating conversion table for use in single phase and two-by-two parallel pole set up.
(Max ambient temperature = 40 °C).

Nominal current rating in three-phase (A)	Nominal current rating in single-phase (2 poles in //) (A)
40	63
63	100
80	125
100	160
125	200
160	250

11.3. Network configurations

11.3.1. 230VAC network configurations (2P)

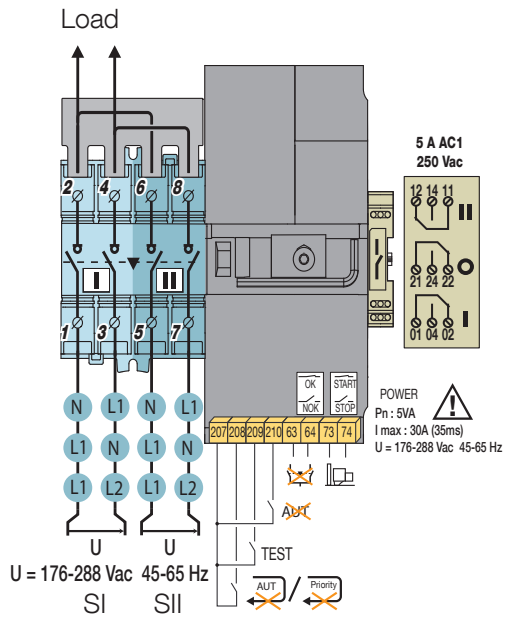

Type of network	Terminal 1	Terminal 3	Terminal 5	Terminal 7
1BL - Single phase	N	L1	N	L1
	L1	N	L1	N
2BL - Two-phase	L1	L2	L1	L2

11.3.2. Configurations réseau 230/400 VAC (4P)

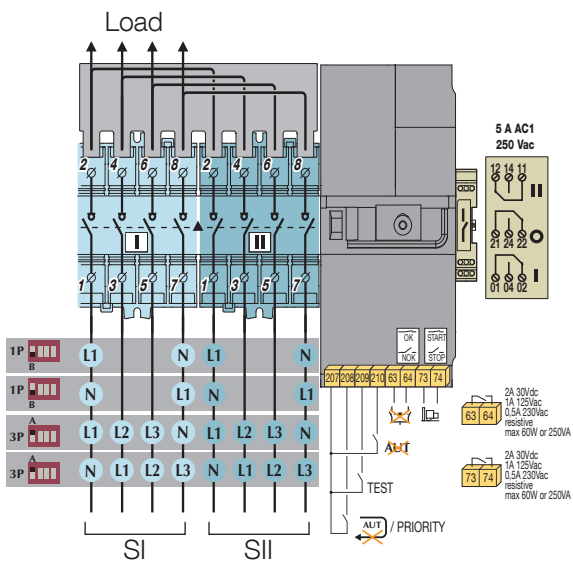

Type of network	Position of the first dip switch	Terminal 1	Terminal 3	Terminal 5	Terminal 7
1BL - Single phase	1P - Position B (dip switch down)	L1	/	/	N
		N	/	/	L1
4NBL - Three-phase with neutral	3P - Position A (dip switch up)	L1	L2	L3	N
		N	L1	L2	L3
3NBL - Three-phase without neutral*	3P - Position A (dip switch up)	L1	L2	L3	Neutral transfo
		Neutre transfo	L3	L2	L1



In case of three-phase without neutral configurations you must first configure the neutral position by wiring the product for the first time with a network 4NBL.

11.3.3. 127 / 230 VAC Network configuration

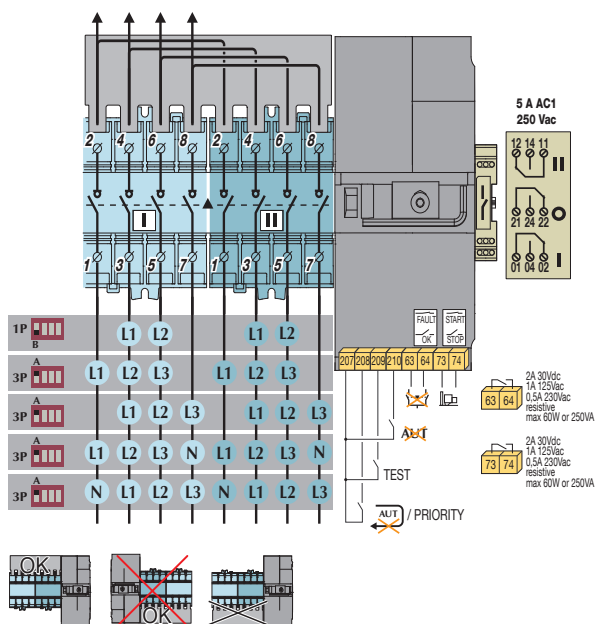

Type of network	Position of the first dip switch	Terminal 1	Terminal 3	Terminal 5	Terminal 7
2BL - Two-phase	1P - Position B (dip switch down)	/	L1	L2	/
3BL - Three-phase without neutral	3P - Position A (dip switch down)	L1	L2	L3	/
		/	L1	L2	L3
4NBL - Three-phase with neutral	3P - Position A (dip switch down)	L1	L2	L3	N
		N	L1	L2	L3

11.3.4. Three phase without neutral network

For three-phase networks without neutral (3NBL) 400Vac, a neutral must be recreated to allow the ATyS M to operate at 230Vac. To recreate the neutral, we recommend the use of quantity 2x 400VA auto-transformers connected as shown below. The neutral position must be defined as neutral on the left or neutral on the right in advance and then wired accordingly. The example below shows the wiring for a product configured with neutral on the left



A new product must have the neutral configuration pre-programmed as on the left or on the right at the first start up using a real (not a recreated) 3 phase + neutral supply.

11.3.4.1. Auto-transformer connections

Reference 1599 4121

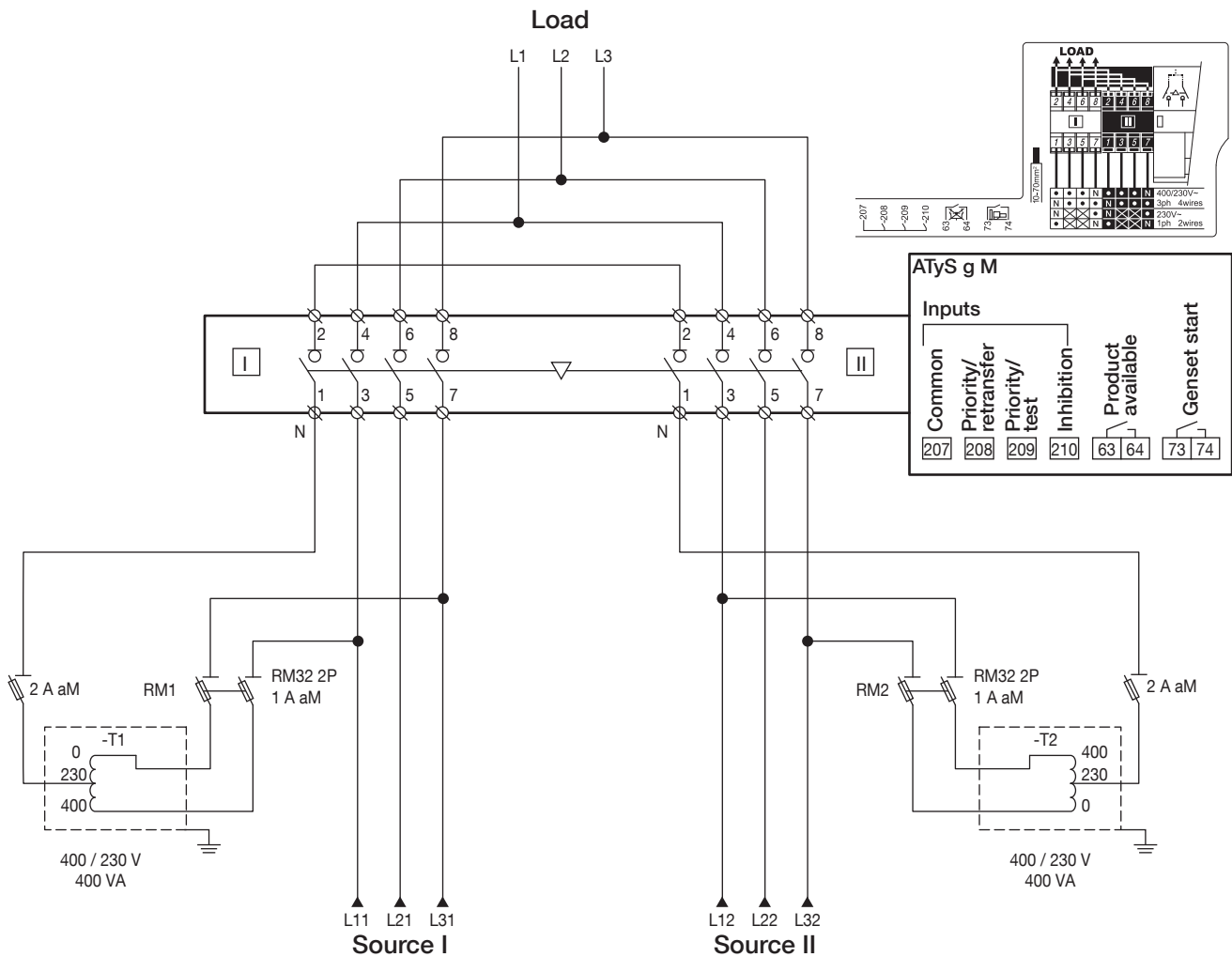

11.3.4.2. Procedure for the configuration and storage of the neutral position.

230/400VAC network configurations without neutral conductors.

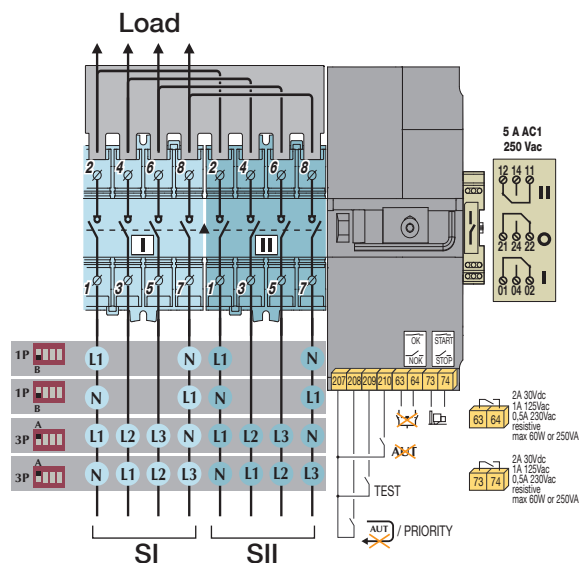

Step 1

It is first necessary to connect the ATyS g M in three-phase + neutral (4NBL) to allow configuration of the neutral position (neutral position is detected at the first power-up).

Step 2

Connect the autotransformers.



Neutral must be connected as shown in the drawing above in section «10.3.4.1. Auto-transformer connections», page 29.

11.3.4.3. Reset of neutral position

In case the network is not recognized by the ATyS g M (or in case you would like to change the neutral position), proceed as follows:

Step 1

Ensure that the product is powered and within voltage limits.
Open the AUTO/MANU cover.

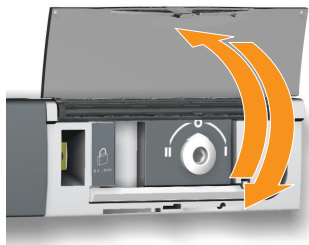

Step 2

Set DIP Switch 1 from 3P to 1P.

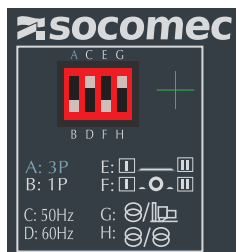

Step 3

Set DIP Switch 1 from 1P to 3P.

Step 4

Close the cover.

End of the procedure for detecting the neutral position.

12. CONNECTION OF CONTROL/COMMAND CIRCUITS



Switch to manual mode before connecting the product. (Front Auto/Manu cover open). The product is delivered in the 0 position.

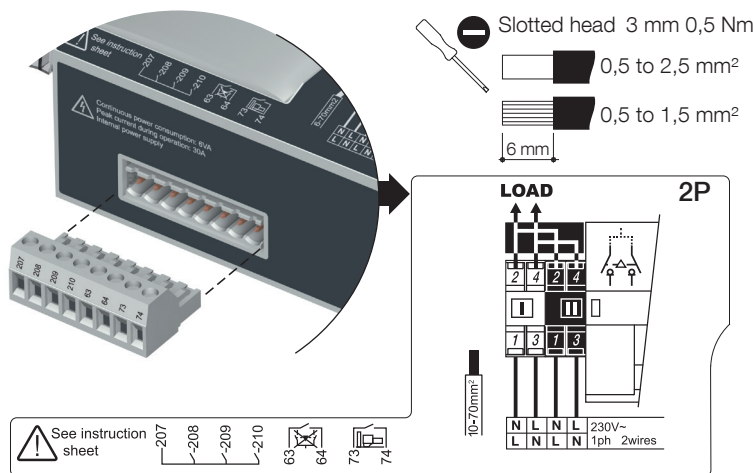
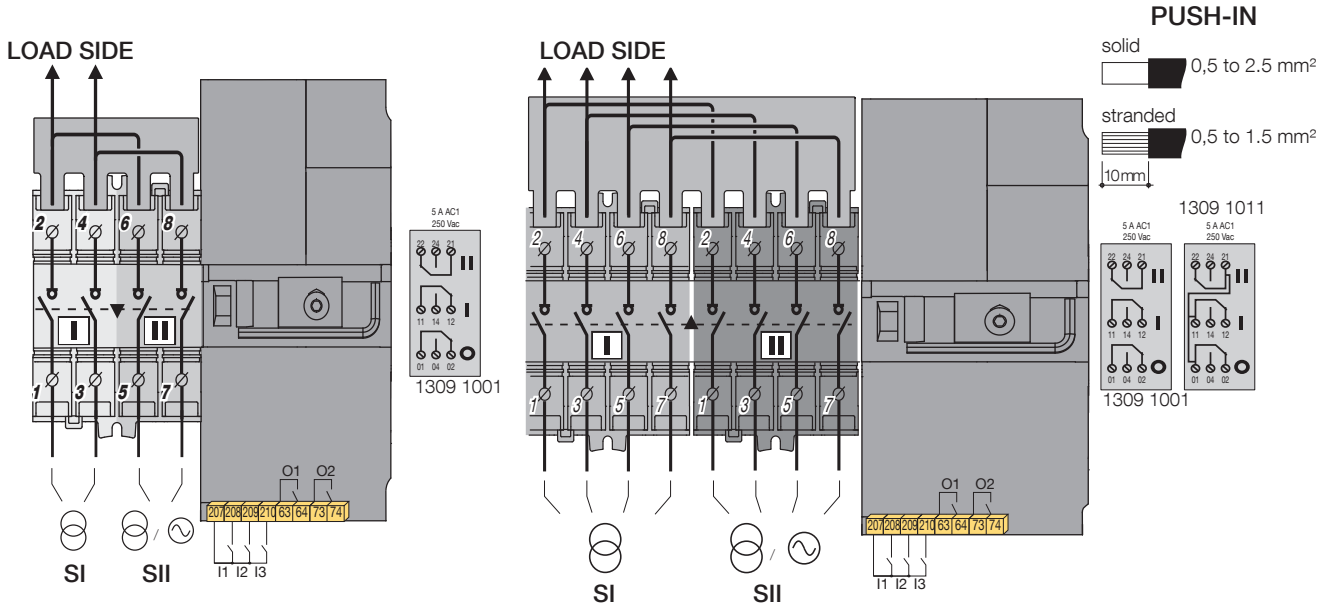

! All pressure on the connector pins is to be avoided during wiring of the auxiliary cables.

! The product is delivered in the 0 position and in auto mode. Maximum control cables length = 10 m. In case of longer distance, use control relays.

Source must always be connected as show above.

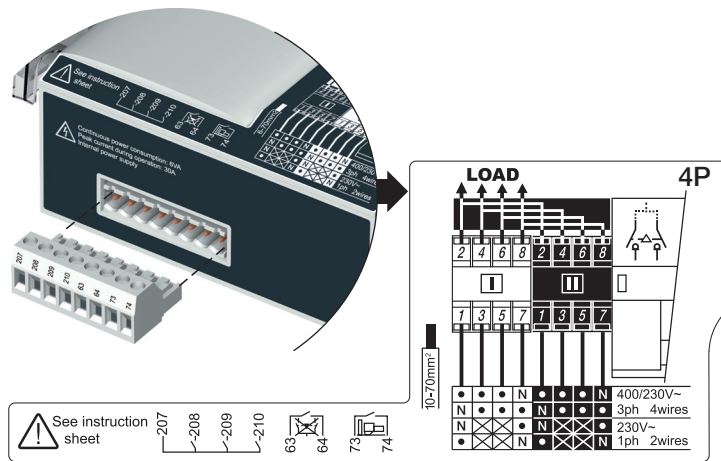

! Ensure that the product is in Manual Mode (front cover open).

12.1. Terminal connectors designation

TYPE	TERMINAL NO.	APPLICATION	STATUS OF THE CONTACT	DESCRIPTION	OUTPUT CHARACTERISTICS	RECOMMENDED CONNECTION CROSS-SECTION
Inputs	I1: 207/208	Network/ Network		With priority	Dry potential free contact	0.5 to 2.5 mm ² (rigid) 0.5 to 1.5 mm ² (stranded)
				Without priority		
		Network- Genset.		Automatic retransfer		
				Manual Retransfer		
	I1: 207/209	Network/ Network		Source priority 1	Dry potential free contact	
				Source priority 2		
Network- Genset.			Stop the test on load			
			Test on load			
I3: 207/210	Network- Network or Network- Generating set		AUTO mode	Dry potential free contact		
			Automatic mode inhibition			
Outputs	O1: 63/64	Network- Network or Network- Generating set		Product not available : - Manual mode - Command default - Electronic default - No source	Resistive load 2A 30 Vdc 0.5A 230Vac Pmax : 60W or 125VA Umax : 30Vdc or 230Vac	
				Product available		
	O2: 73/74	Network- Genset.		No start command genset	Resistive load 2A 30 Vdc 0.5A 230Vac Pmax : 60W or 125VA Umax : 30Vdc or 230Vac	
				Generating set starting		

TYPE	TERMINAL NO.	STATUS OF THE CONTACT	DESCRIPTION	OUTPUT CHARACTERISTICS	RECOMMENDED CONNECTION CROSS-SECTION
Auxiliary contact block 1309 1001	11/12/14		Changeover switch in position I	250V AC 5A AC1 24VDC 2A AC13 - 250VAC - 2A	0.5 to 2.5 mm ² (rigid)
	21/22/24		Changeover switch in position II	250V AC 5A AC1 24VDC 2A AC13 - 250VAC - 2A	
	01/02/04		Changeover switch in position 0	250V AC 5A AC1 24VDC 2A AC13 - 250VAC - 2A	
Auxiliary contact block 1309 1011	11/12/14		Changeover switch in position I	250V AC 5A AC1 24VDC 2A AC13 - 250VAC - 2A	0.5 to 1.5 mm ² (stranded)
	21/22/24		Changeover switch in position II	250V AC 5A AC1 24VDC 2A AC13 - 250VAC - 2A	
	01/02/04		Changeover switch in position 0	250V AC 5A AC1 24VDC 2A AC13 - 250VAC - 2A	

12.2. Auxiliary contact operating schedule

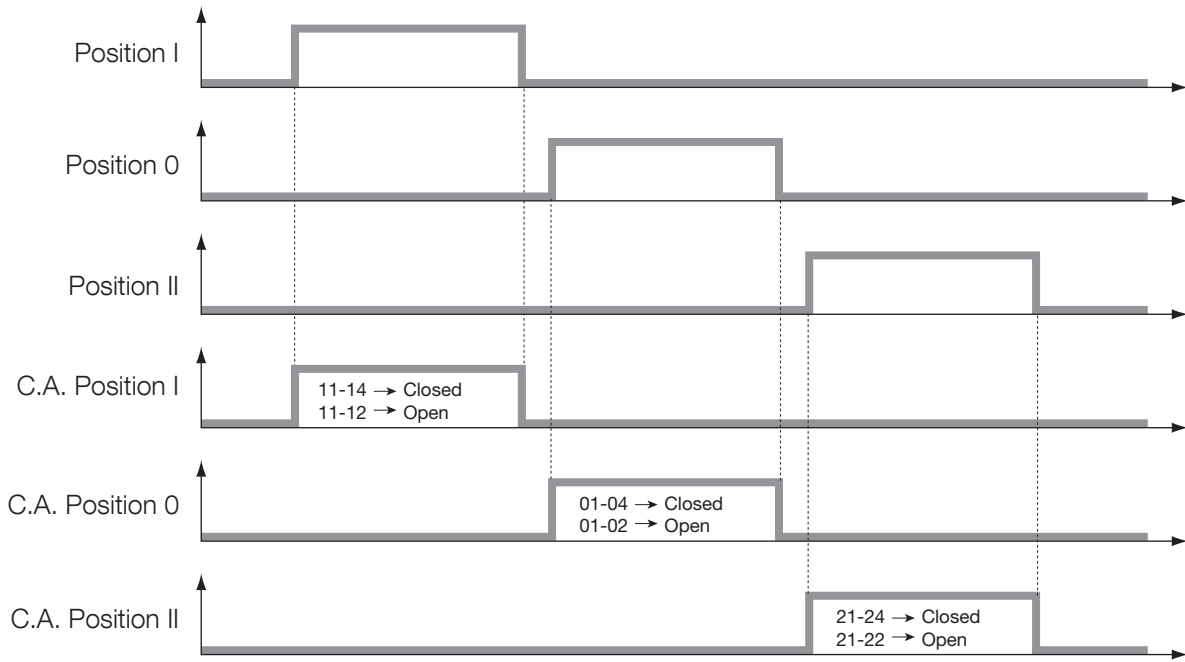

13. OPERATION

13.1. Presentation of the product interface

13.1.1. 2P product interface

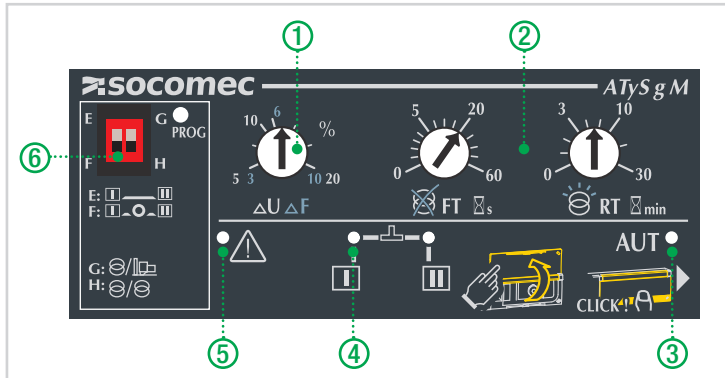

- | | |
|---|---|
| 1. Adjustment potentiometers voltage and frequency thresholds | 4. Source I and Source II availability indicators |
| 2. Potentiometers to set timers | 5. Fault LED |
| 3. Auto LED | 6. Dip switches |

13.1.2. 4P product interface

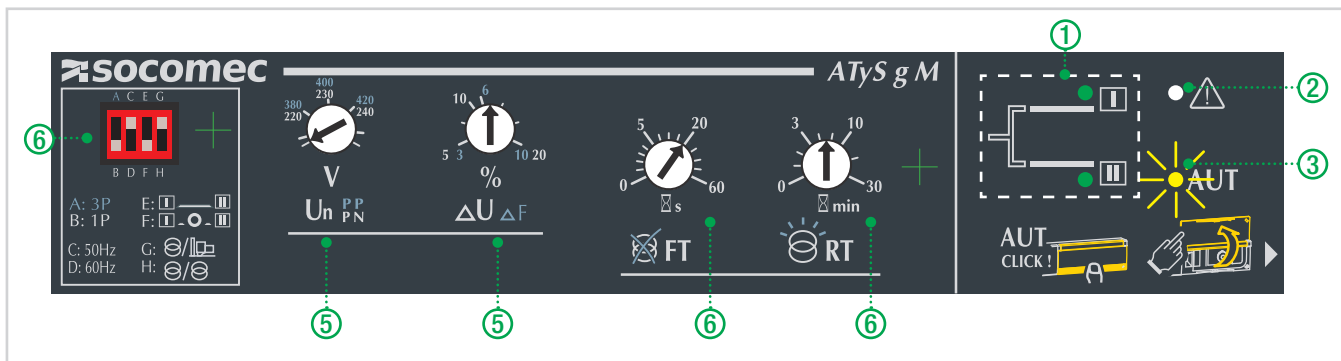

- | | | |
|---|--|---------------------------------|
| 1. Source I and Source II availability indicators | 4. Dip switches | 6. Potentiometers to set timers |
| 2. Fault LED | 5. Adjustment potentiometers of the rated voltage and frequency and voltage thresholds | |
| 3. Auto LED | | |

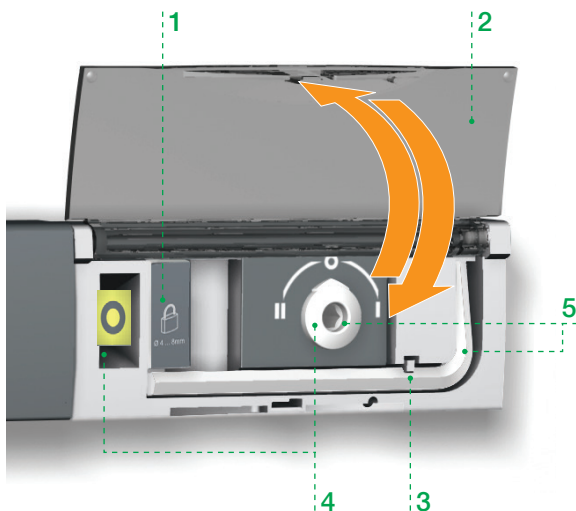

1. Locking

- Option to padlock using a 1 x 8 mm max. padlock.

2. AUT/MAN cover

- Open the cover to switch to manual mode.
- Close the cover to return to automatic (remote control) mode.
- Open and close the cover to clear faults.

3. Auto/Manual mode sensor

4. Switch position indicators

- Display of position I, 0, II.

5. Manual switching

- Insert the Allen key (5.0 mm) provided and turn to switch manually.
- Manual operation is not possible when padlocked.

13.1.3. Reset

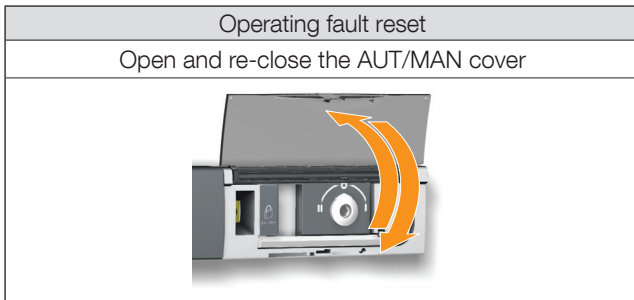

13.2. Manual mode

To access manual mode, open the Aut/Man cover.

Once manual mode is active (cover open) it is possible:

- To lock the changeover switch.
- To access the DIP switches programming.
- To manually operate the changeover switch using the handle.

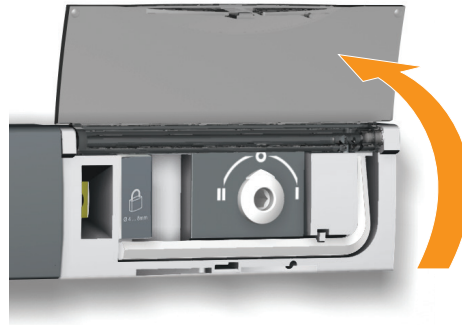

As soon as manual mode is activated, remote orders are inhibited (except the Genset start order in case of a mains loss).

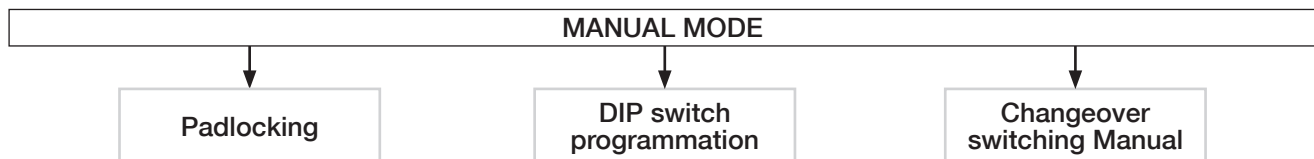

13.2.1. Manual switching

Use the handle situated on the front panel under the cover to manoeuvre the changeover switch. To simplify the operation, it is advised to also use the handle extension that is delivered with the product.

Check the changeover switch position on the indicator situated on the front panel before making any operation.

- From position I, turn anti-clockwise to get to position 0
- From position 0, turn anti-clockwise to get to position II
- From position II, turn clockwise to get to position 0
- From position 0, turn clockwise to get to position I

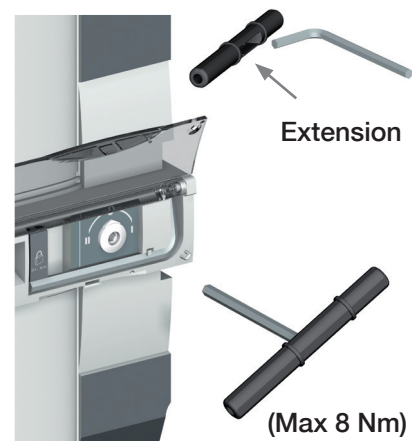

Do not force the product (Max 8 Nm).

13.3. Padlocking

Enables locking in the 0 position (factory configuration) or in positions I, 0 or II (user configurable).

It is necessary to configure padlocking to all positions before installation as access to configuration is at the back of the product. Refer to section «7.1. Changing the padlocking configuration», page 19

Locking is only possible in manual mode (cover open).

Pull on the locking handle to enable the interlock. Lock by inserting a padlock into the orifice provided for this purpose.

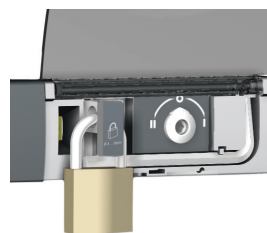

4 mm min
3/16" min
8 mm min
5/16" min

13.4. Programming

Whilst in manual mode check the wiring and installation. If ok power up the product. This product must always be put into service by qualified and approved personal. The LED signalling is only active when the product supply is on (supply LED lit). To set the dip switches, it is necessary to open the AUTO/MANU cover.

The commissioning must always result in having at least 1 LED source available lit. Therefore, the voltage and frequency must be within the defined thresholds.



Any action on the potentiometers changes the settings, even if the cover is closed.

13.4.1. Single phase versionw

A Dip switch settings

Stop in 0 position: E-F
 E: No stop in O position
 F: 2s stop in O position

Type of application: G-H
 G: Network - Genset
 H: Network - Network

B Hysteresis settings

HYST: 20 % Δ U/F
 Δ U: 5-20%
 Δ F: 3-10%

C Timer settings

Loss of priority source timer

FT: 0-60 sec.

Return of priority source timer

RT: 0-30 min.

D Source supply voltage and frequency Auto-Configuration settings

Ensure that the supply voltage is available and within the following limits:
 Un: 176-288VAC
 Fn: 45-65Hz

Press PROG for \geq 2s

LED state	Auto Conf result	Action
Steady ON	OK	Ready
Blinking	Not OK	Repeat step D

E LED info

Source availability LED

Source	LED ON	LED OFF	LED blinking
	Source 1 available	Source 1 not available or out of range	- a timer is counting down - test mode
	Source 2 available	Source 2 not available or out of range	- a timer is counting down

Fault and state of the product LED's

	LED ON	LED OFF	LED blinking
	Fault	Product OK or S1-S2 not available	Please wait
	Auto mode	Manual mode	Manual retransfer

ATyS g M

Labels: E, F, G, H, PROG, Δ U Δ F, FT s, RT min, AUT, CLICK!

Fault reset



13.4.2. Three phase version

The LED signalling and operation is only active when the product supply is available.



To set the dip switches, it is necessary to open the Auto/Manual cover.

Commissioning must always result in having at least 1 LED source available on.

(Therefore, the voltage and frequency must be within the defined thresholds).

⚠ Any action on the potentiometers will change the settings, even when the cover is closed.

A Dip switch settings

Type of network: A-B
A: 3P
B: 1P

Frequency: C-D
C: 50 Hz
D: 60 Hz

Stop in 0 position: E-F
E: No stop in 0 position
F: 2s stop in 0 position

Type of application: G-H
G: Network - Genset
H: Network - Network

B Source voltage supply configuration

127/230 Vac version



Un (P-P): 208-240 Vac
Un (P-N): 120-138 Vac

230/400 Vac version

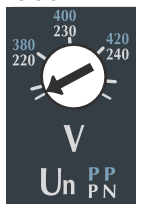

Un (P-P): 380-420 Vac
Un (P-N): 220-240 Vac

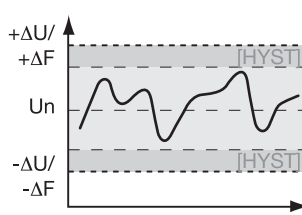

HYST: 20 %ΔU/F
ΔU: 5-20%
ΔF: 3-10%

C Timer settings

Loss of priority source timer

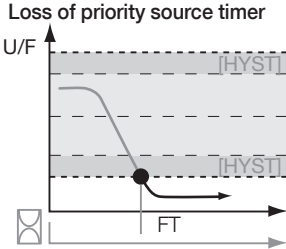

FT: 0-60 sec.

Return of priority source timer

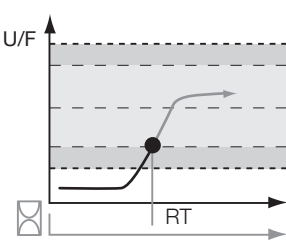

RT: 0-30 min.

D LED info

Source availability LED

Source	LED ON	LED OFF	LED blinking
	Source 1 available	Source 1 not available or out of range	- a timer is counting down - test mode
	Source 2 available	Source 2 not available or out of range	- a timer is counting down

Fault reset

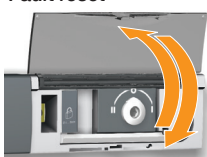

Fault and state of the product LED's

Icon	LED ON	LED OFF	LED blinking
	Fault	Product OK or S1-S2 not available	Please wait
AUT	Auto mode	Manual mode	Manual retransfer

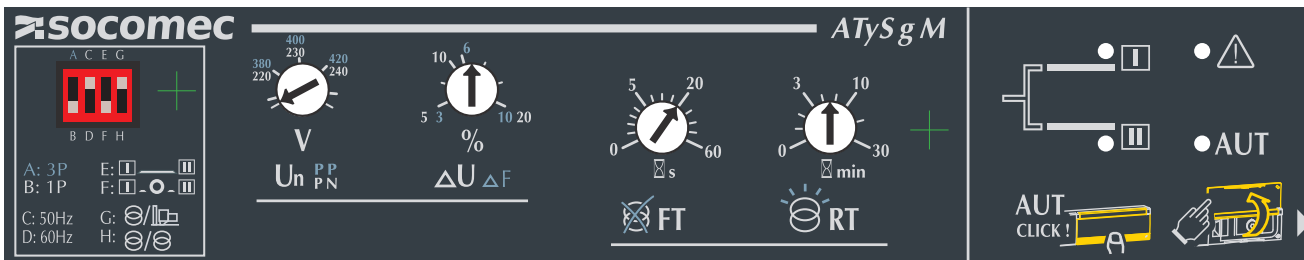

CDT and DTT timers are fixed:

Genset cooling time: 4min and validation of secondary network / backup source stability = 5 sec.

13.4.3. Sealable configuration cover

Configuration settings may be protected by means of a sealable cover. Refer to section «4. Optional accessories», page 17.

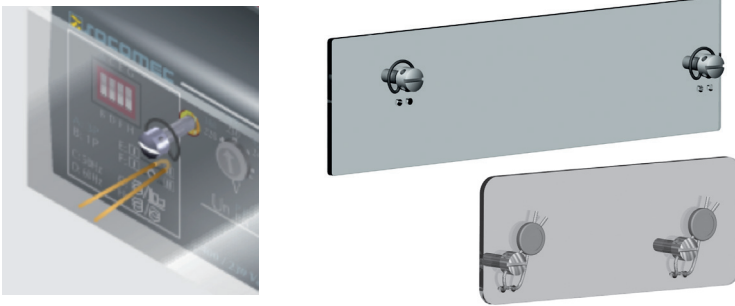

13.5. Automatic mode

Close the cover to enter automatic mode. Make sure that the changeover switch is in automatic mode (AUT LED lit).

13.5.1. Sealable Auto/Manual cover

Auto/Manu mode can be protected by sealing the standard Auto/Manual cover as shown.

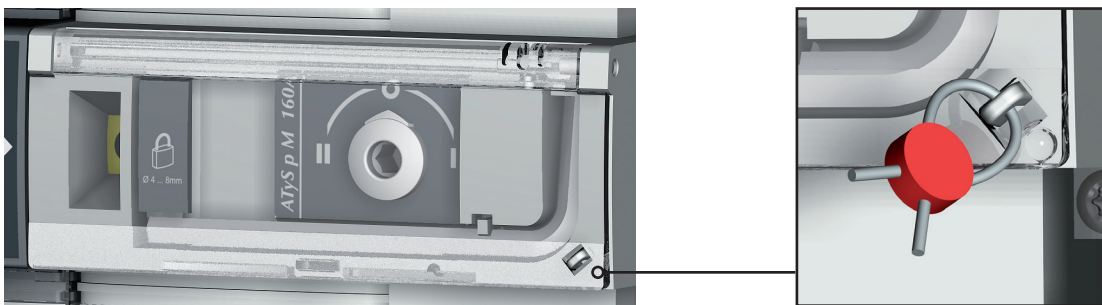

13.6. Possible actions

Once in automatic mode, it is possible to:

- Activates on load test
- Run a source I or source loss sequence II,
- start a restoration sequence source I or source II.

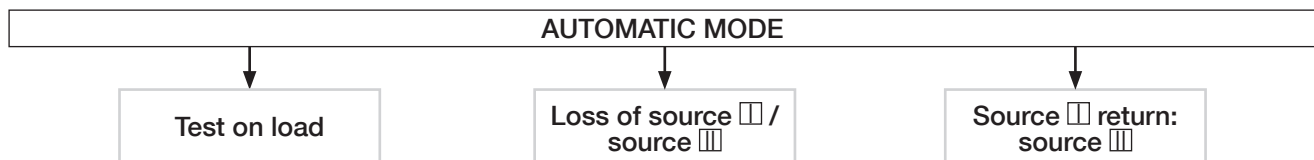

13.7. Manual & Automatic Mode / Mains restoration conditions

- Automatic mode returns to active 2 seconds after switching from manual to automatic mode.
- Source I source II voltages and frequencies are checked to define the changeover switch's new stable status.
- The same automatic mode recognition sequence must be executed following power-off and complete discharge of the power reserves.

Mode settings

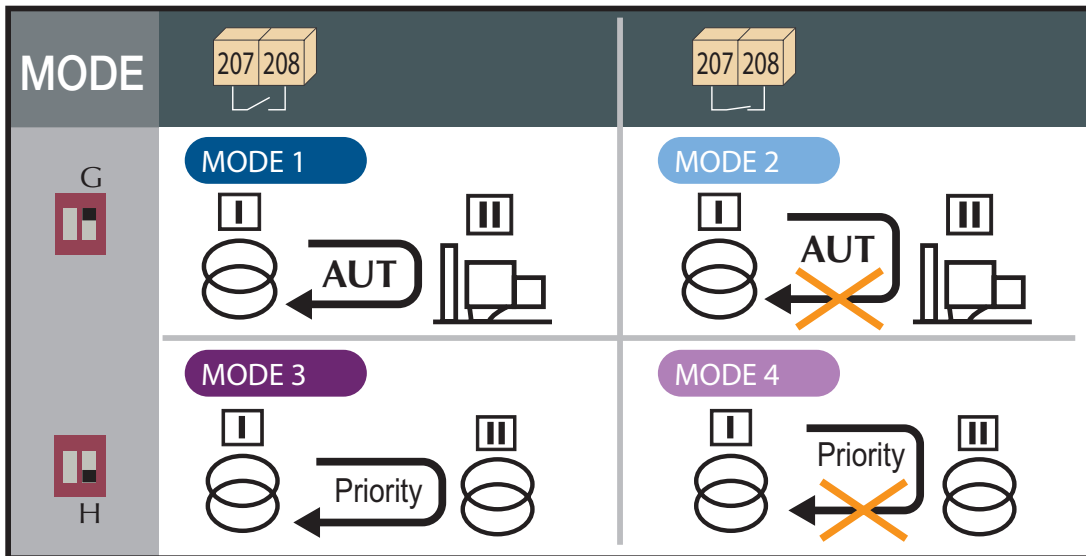

13.7.1. Mode 1: Automatic retransfer

Network - Genset applications

- Contact 207/208 open => automatic retransfer

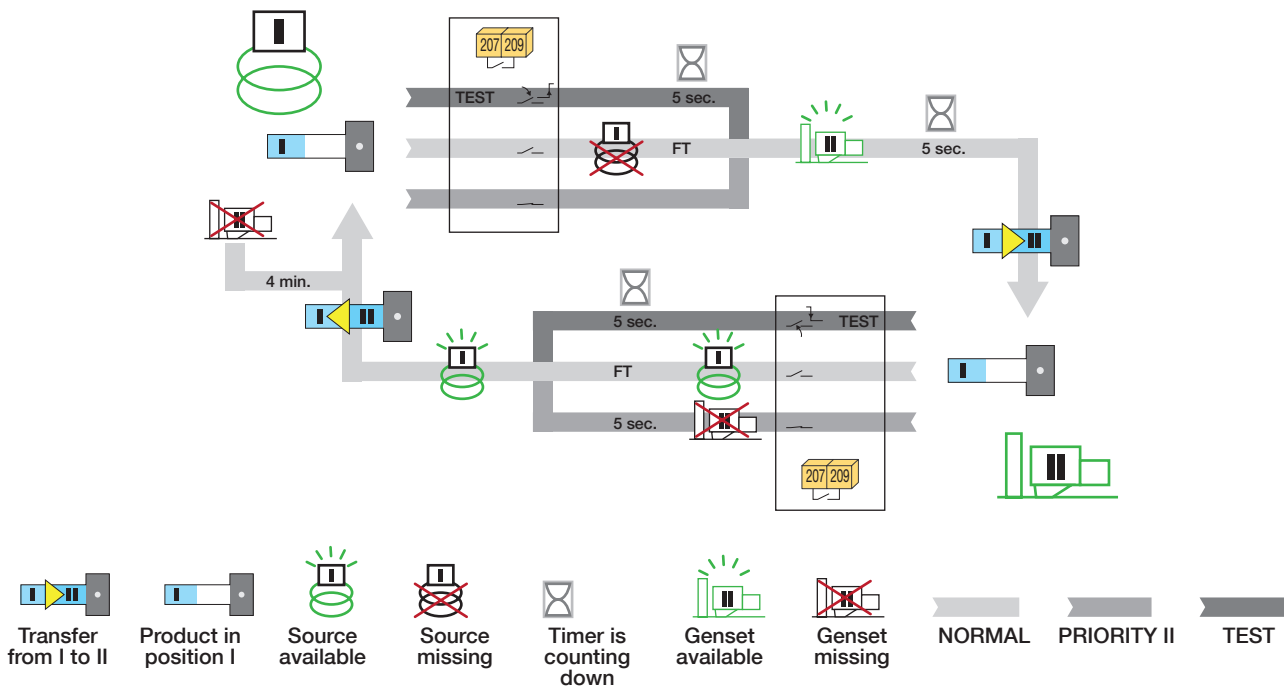

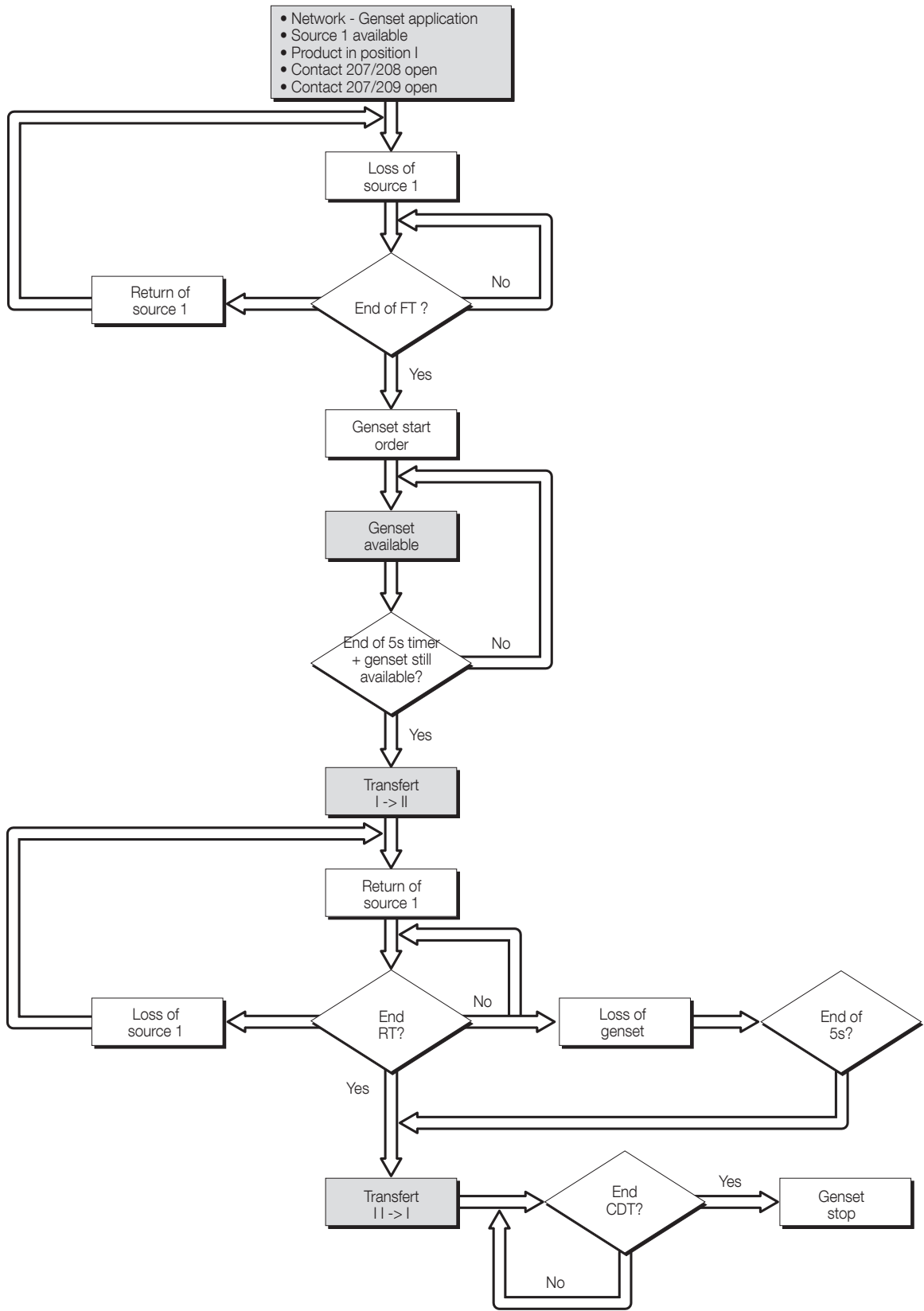

CDT = cool down timer fixed at 4 min.

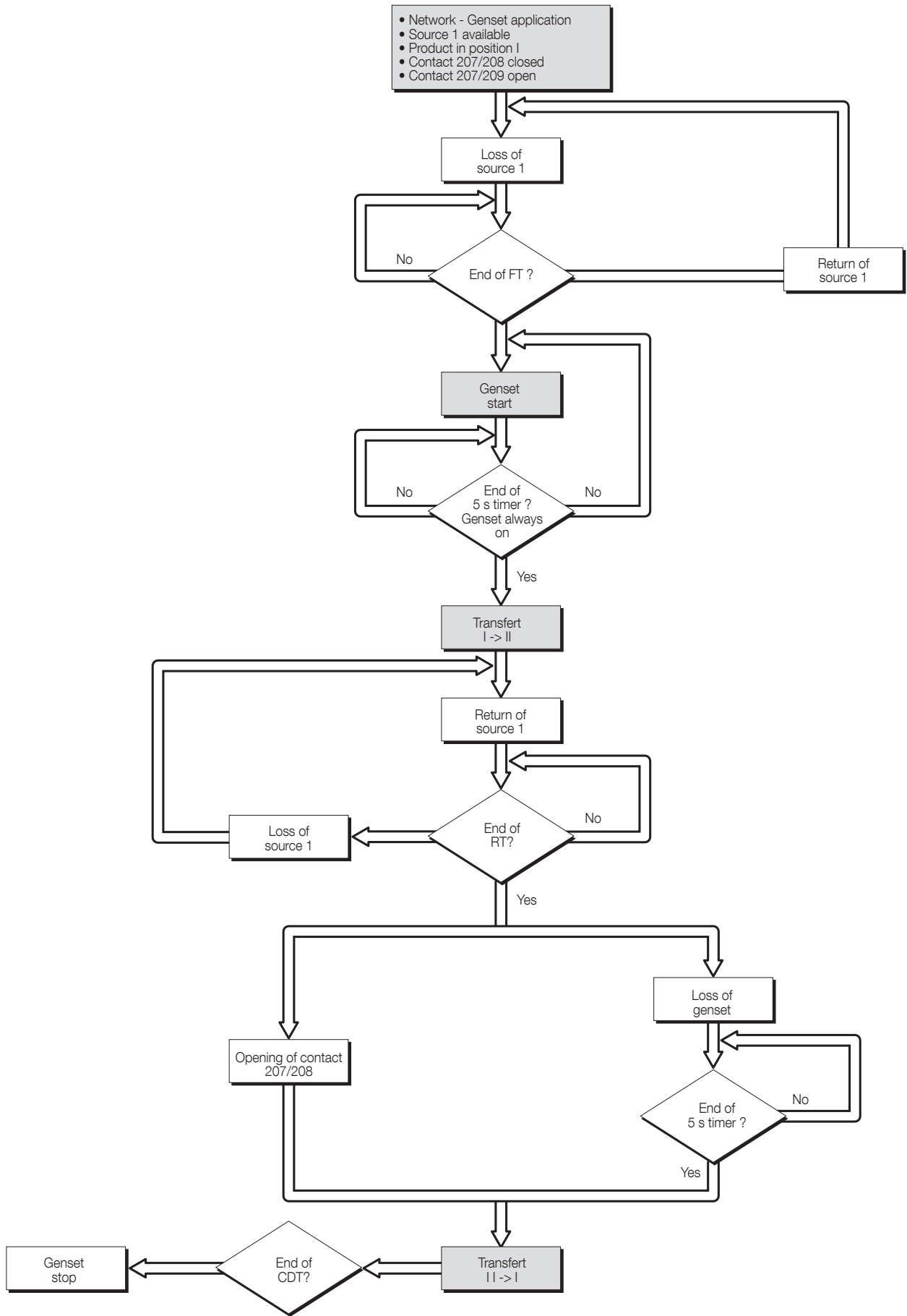

CDT = cool down timer fixed at 4 min.

13.7.3. Mode 2b: Controlled transfer

Network - genset application

- Contact 207/208 closed => Test on load

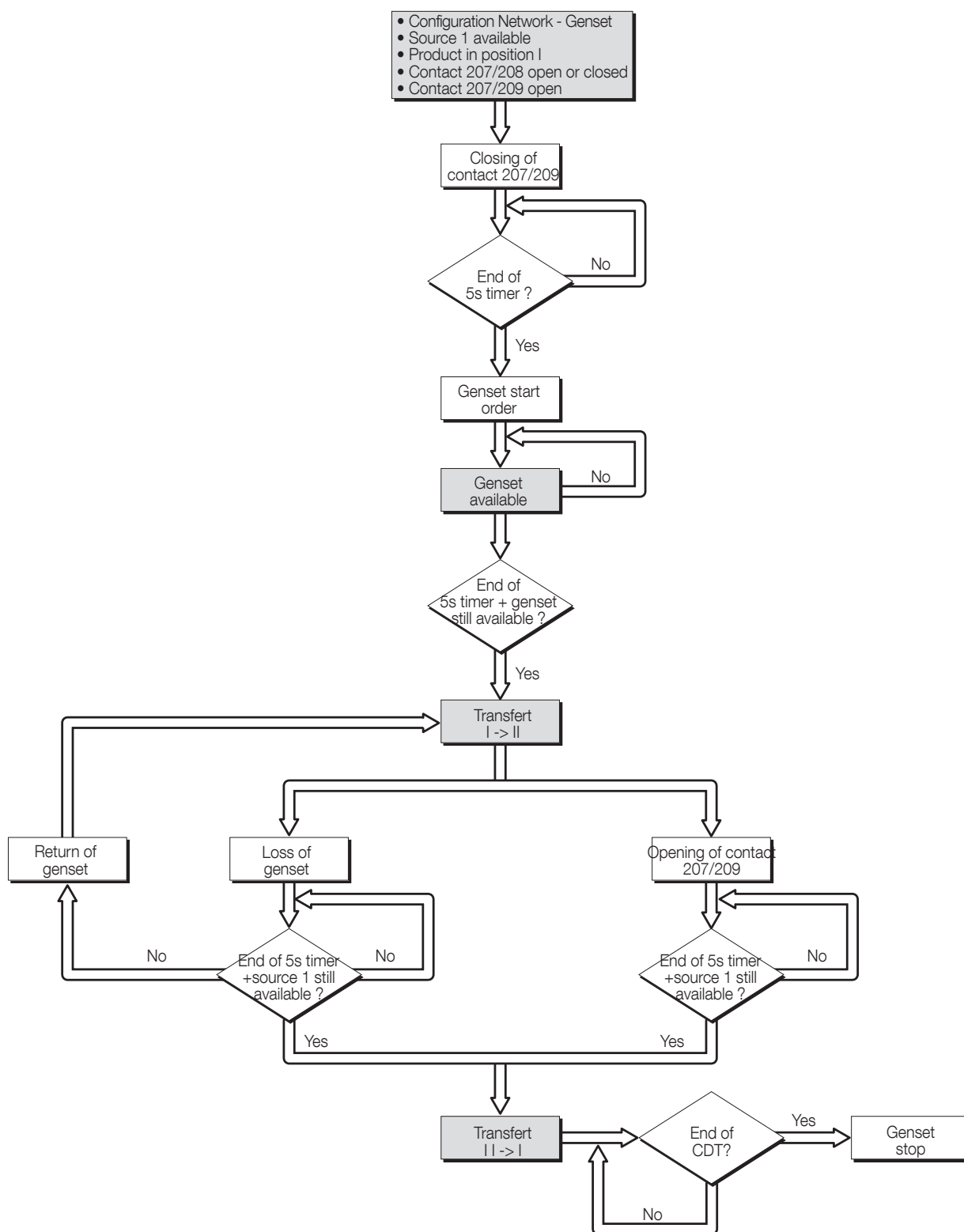

CDT = cool down timer fixed at 4 min.

13.7.4. Mode 3: Network - Network application with priority

Network - network application

- Contact 207/208 open => functioning with priority.

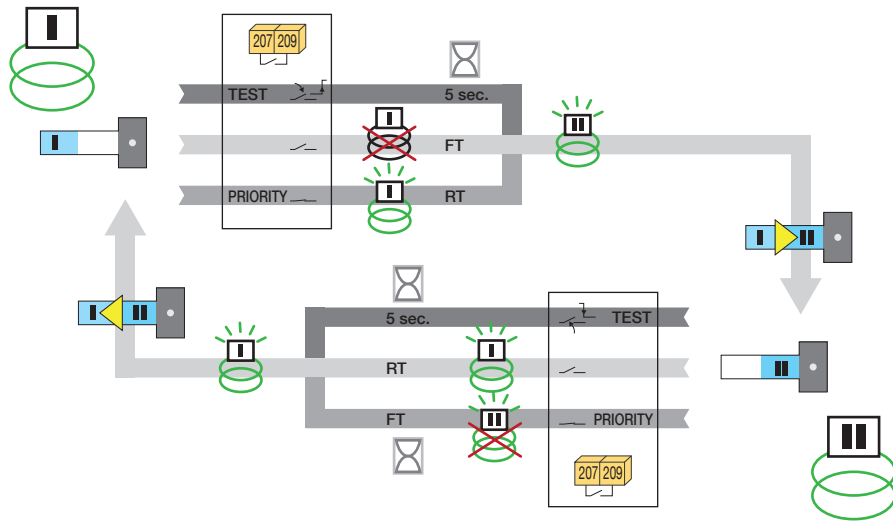

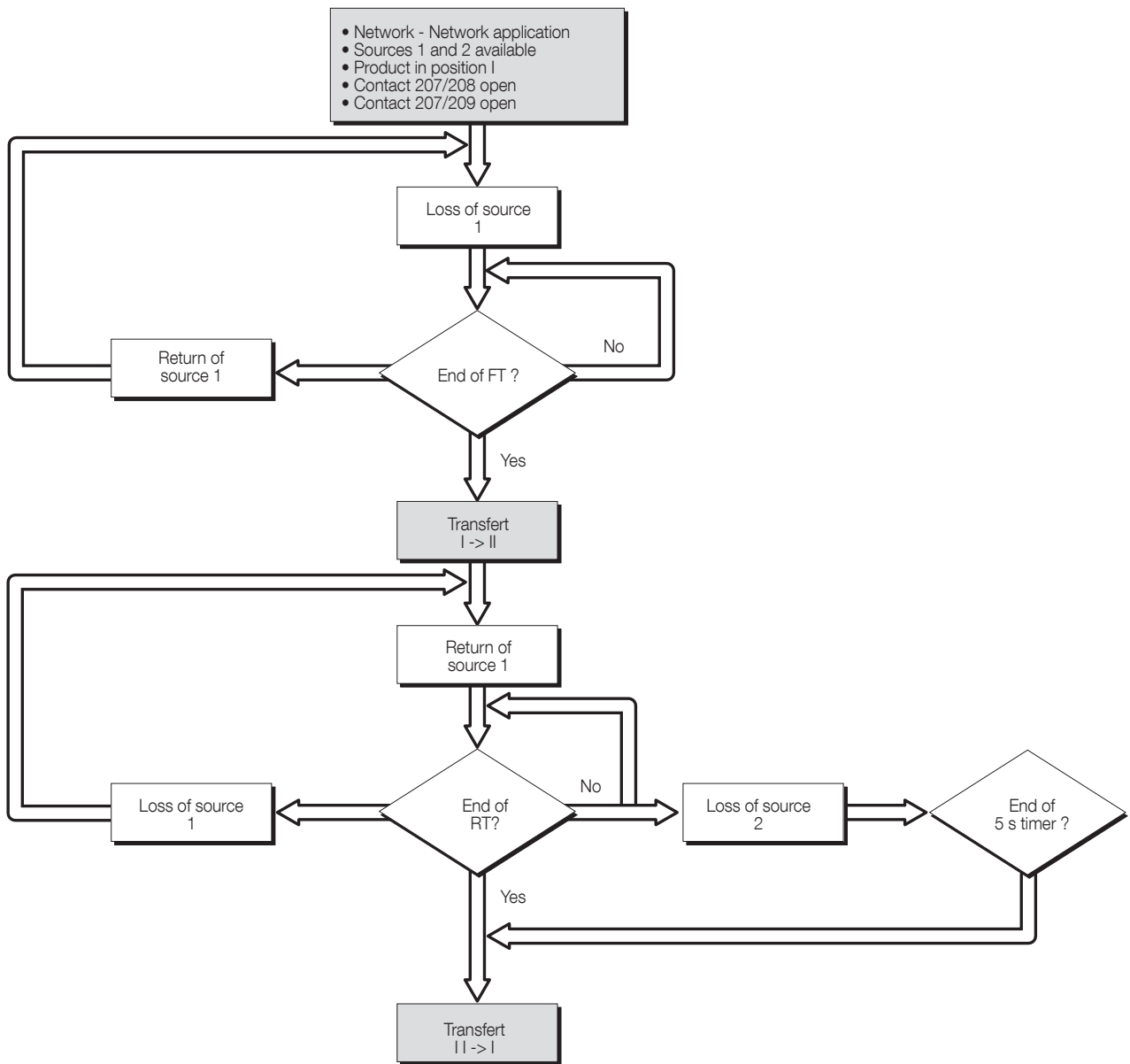

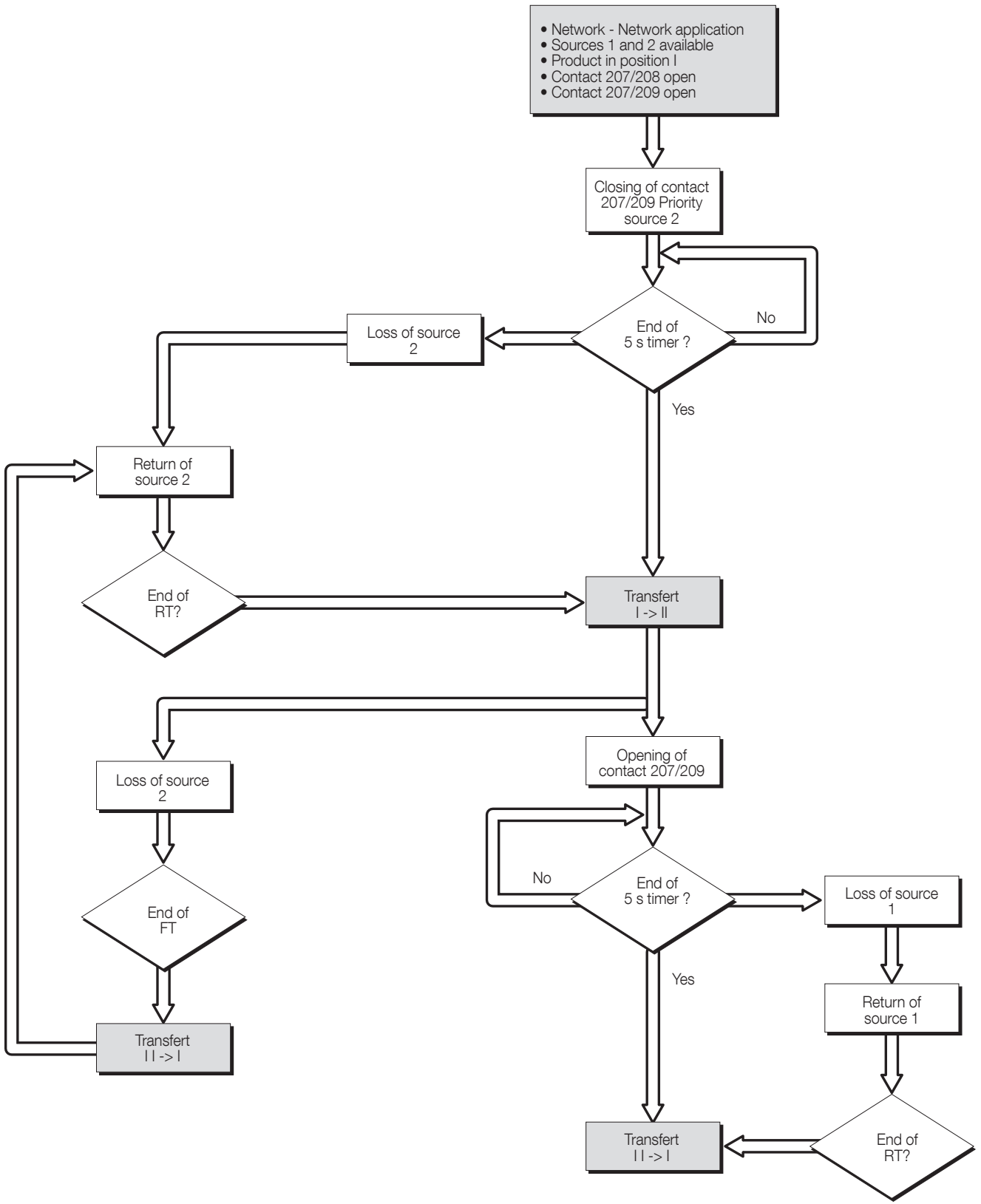

13.7.5. Mode 4: Network - Network application without priority

Network - Network application

- Contact 207/208 closed => functioning without priority.

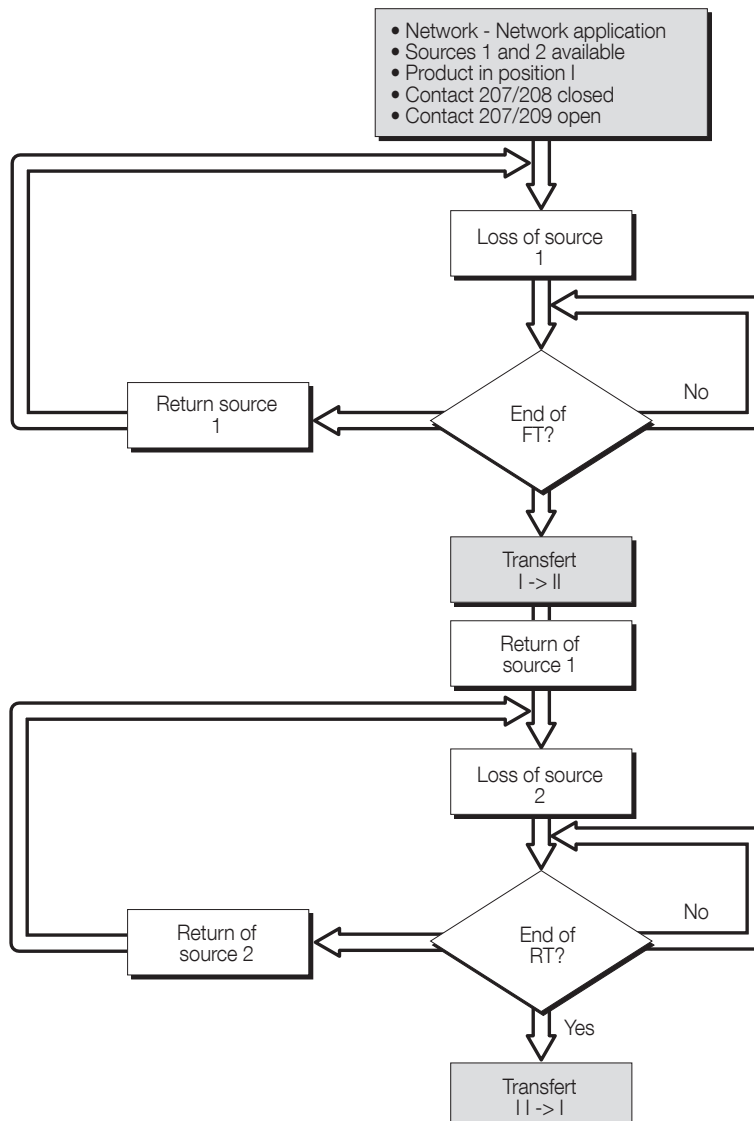
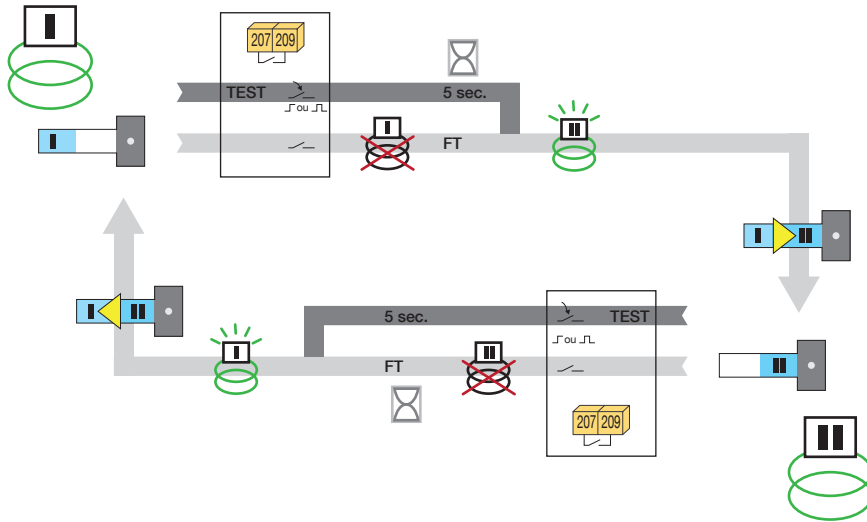

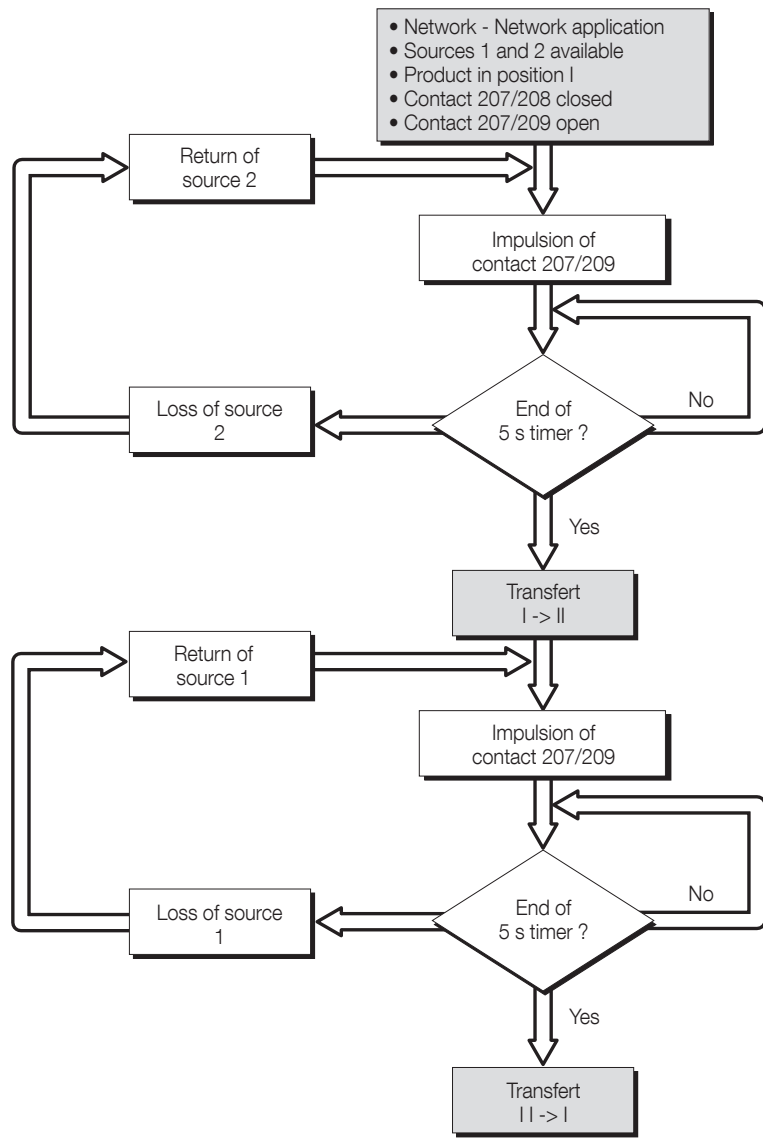

14. PREVENTATIVE MAINTENANCE

It is recommended to operate the product at least once a year.

I - O - II - O - I

Note: Maintenance should be planned carefully and carried out by qualified and authorised personnel. Consideration of the critical level and application where the product is installed should form an essential and integral part of the maintenance plan. Good engineering practice is imperative whilst all necessary precautions must be taken to ensure that the intervention (whether directly or indirectly) remains safe in all aspects.



The use of any Megohmmeter is prohibited on this product as the connection terminals are intrinsically connected to the sensing circuit.

15. TROUBLESHOOTING GUIDE

SYMPTOMS	ACTIONS TO BE CARRIED OUT	EXPECTED RESULTS
Adjustment potentiometers of the rated voltage and frequency and voltage thresholds	<p>Check for a voltage of 176 to 288 Vac on the supply terminals:</p> <ul style="list-style-type: none"> • 127/230 Vac model: <ul style="list-style-type: none"> - Terminals 3-5 correspond to SOURCE 1 - Terminals 3-5 correspond to SOURCE 2 • 230/400 Vac model: <ul style="list-style-type: none"> - Terminals 1-7 correspond to SOURCE 1 - Terminals 1-7 correspond to SOURCE 2 	The "AUT" LED is lit (if the cover is closed)
The "Priority SOURCE Availability" LED does not come on	<p>Check the following parameters:</p> <ul style="list-style-type: none"> • the type of network => 3P (DIP Switch 1 on position A) <ul style="list-style-type: none"> 1P (DIP Switch 1 on position B) • frequency => <ul style="list-style-type: none"> 50 Hz (DIP Switch 2 on position C) 60 Hz (DIP Switch 2 on position D) • the nominal voltage => with a multimeter, measure the voltage across the terminals and report the value on the potentiometer. <p>Check the thresholds and hysteresis of rated voltages (ΔU) and frequencies (ΔF) and report them on the corresponding potentiometer.</p> <p>If using an Auto transformer - proceed as follows upon 1st switching on</p> <ul style="list-style-type: none"> • Step 1: ATyS M6s must be connected to a three-phase + neutral network (4NBL) for setting the neutral position. Neutral position is detected upon first switching on. • Step 2: Connect the autotransformers. Warning: Neutral must be connected on the same side as in step 1. <p>How to reset the neutral position:</p> <ul style="list-style-type: none"> • Step 1: Open the cover • Step 2: Set DIP Switch 1 from 3P to 1P • Step 3: Set DIP Switch 1 from 1P to 3P • Step 4: Close the cover 	The "Priority SOURCE Availability" LED is lit
The "Emergency SOURCE Availability" LED does not come on	<p>Check the following parameters:</p> <ul style="list-style-type: none"> • the type of network => 3P (DIP Switch 1 on position A) <ul style="list-style-type: none"> 1P (DIP Switch 1 on position B) • frequency => <ul style="list-style-type: none"> 50 Hz (DIP Switch 2 on position C) 60 Hz (DIP Switch 2 on position D) • the nominal voltage => with a multimeter, measure the voltage across the terminals and report the value on the potentiometer. <p>CAUTION: a Generator operating off load can generate a Fr and a U lower than the nominal values: Check the thresholds and hysteresis of rated voltages (ΔU) and frequencies (ΔF) and report them on the corresponding potentiometer.</p> <p>If using an Auto transformer - proceed as follows upon 1st switching on</p> <ul style="list-style-type: none"> • Step 1: ATyS M6s must be connected to a three-phase + neutral network (4NBL) for setting the neutral position. Neutral position is detected upon first switching on. • Step 2: Connect the autotransformers. Warning: Neutral must be connected on the side defined in Step 1. <p>How to reset the neutral position:</p> <ul style="list-style-type: none"> • Step 1: Open the cover • Step 2: Set DIP Switch 1 from 3P to 1P • Step 3: Set DIP Switch 1 from 1P to 3P • Step 4: Close the cover 	The "Emergency SOURCE Availability" LED is lit

SYMPTOMS	ACTIONS TO BE CARRIED OUT	EXPECTED RESULTS
The product remains switched off after the Priority SOURCE is lost	Check if voltage is between 176 to 288 VAC across the power supply terminals of emergency SOURCE : <ul style="list-style-type: none"> • 127 /230 Vac model: - Terminals 3-5 corresponding to the Emergency Source • 230/400 Vac model: - Terminals 1-7 corresponding to the Emergency Source 	The "AUT" LED is lit
	In case of transformer /Genset, check that FT timer (Main Failure Timer) has finished counting down. <ul style="list-style-type: none"> • Use a stopwatch. • Start the stopwatch when the product has lost its Priority SOURCE. - Contact 73 - 74 must be closed after 60s max (M-G application) - GENSET run command = Contact 73-74 Closed - GENSET stop = Contact 73-74 Open 	The Genset works and the LED «Emergency Source Disponibility» is lit
The product does not switch over after the Priority SOURCE is lost	Check that the product is not in manual mode: <ul style="list-style-type: none"> - Automatic mode = Cover closed - Manual mode = Cover open 	The "AUT" LED is lit
	Check that automatic operation has not been inhibited by external control commands (terminals 207-210)	
	Check the status of led « Emergency SOURCE availability ».If it is off, refer to the symptom concerned (higher in the list)	The "AUT" and "Emergency SOURCE Availability" LEDs are lit
	In case of transformer /Transformer, check the setting of FT timer (Main Failure Timer). The duration of this time delay is between 0 and 60s. If necessary, use a stopwatch to check switching to SOURCE after FT countdown.	At the end of the time delay, the product switches to mechanical position 0, and to emergency SOURCE.
The product does not switch over when the Priority SOURCE is restored	Check that the product is not in manual mode: <ul style="list-style-type: none"> - Automatic mode = Cover closed - Manual mode = Cover open 	The "AUT" LED is lit
	Check that automatic operation has not been inhibited by external control commands (terminals 207-210)	
	Check the state of the "Priority Source Availability" LED. If it is off, refer to the symptom concerned (higher in the list)	The "AUT" and "Emergency SOURCE Availability" LEDs are lit
	Check the setting of RT timer (Main Return Timer).The duration of this delay is between 0 and 30 min. Use a stopwatch to check the switch to Priority SOURCE after the RT timer.	At the end of the time delay, the product switches to mechanical position 0, and to priority SOURCE.
	Check that the "manual retransfer" function is not active* <ul style="list-style-type: none"> • Retransfer mode activated = Contact 207-208 closed • Retransfer mode deactivated = Contact 207-208 open * if this function is not required.	Contact 207-208 must be open to enable switching to priority SOURCE
Return to Priority SOURCE has been executed, but the Emergency Source (for a Generator) continues to operate	Check CDT timer (Cool Down Timer) has finished counting down - Fixed time delay:4 min <ul style="list-style-type: none"> • Use a stopwatch. - Start the stopwatch when the product has switched over to the Priority SOURCE. - Contact 73-74 must be open after time delay CDT has finished counting down 	The GenSet switches off and led « Emergency SOURCE availability » is OFF
	Check that the product is not in Automatic mode: <ul style="list-style-type: none"> - Automatic mode = Cover closed - Manual mode = Cover open 	The "AUT" LED is lit
	Check that automatic operation has not been inhibited by external control commands (terminals 207-210)	
ON LOAD TESTS cannot be launched	Check that the product is not in Automatic mode: <ul style="list-style-type: none"> - Automatic mode = Cover closed - Manual mode = Cover open 	The "AUT" LED is lit
	Check that automatic operation has not been inhibited by external control commands (terminals 207-210)	
	Check if the ON Load test has started: <ul style="list-style-type: none"> • On Load Test activated = Contact 207-209 Closed • On Load Test inhibited = Contact 207-209 Open 	The ON LOAD TEST starts.

SYMPTOMS	ACTIONS TO BE CARRIED OUT	EXPECTED RESULTS
The product cannot be switched over using the handle	Check the direction of rotation of the handle: <ul style="list-style-type: none"> • Manual switchover from position 1 to position 2 is executed clockwise. • The return operation is executed anti-clockwise 	The product can be switched over using the handle
	Check that the product is not padlocked	
	Use the handle extension on the ALLEN key to check that the appropriate adjustment torque is applied.	
	When using a single AC, check that the length of the screws used is not greater than 20 mm	
AUTOMATIC mode is not activated even though the cover is closed	Check that the plastic pin is in place on the bottom of the cover. This pin activates the sensor which indicates the position of the cover (open or closed).	The "AUT" LED is lit
	Check that automatic operation has not been inhibited by external control commands (terminals 207-210)	
The product cannot be locked	Check the mechanical position of the changeover switch: <ul style="list-style-type: none"> • Locking is only possible in position 0 as standard • Locking in positions 1-0-2 is possible by modifying the product in accordance with the instructions 	Locking is possible
The product is faulty	Check status of contact 63-64 (Product available): <ul style="list-style-type: none"> • Product available: 63-64 = closed Product non available : 63-64 = open Product available = A product which is within voltage and frequency limits without any internal failure.	FAULT LED is OFF
	Open and close the cover to reset the fault;	
	If the product is still faulty	Product must be returned to factory for troubleshooting

CORPORATE HQ CONTACT:
SOCOMECSAS
1-4 RUE DE WESTHOUSE
67235 BENFELD, FRANCE

www.socomec.com



 **socomec**
Innovative Power Solutions