

ly terminals	A1-A2
Rated supply voltage(Un)	AC220V,AC380V
Rated frequency	50/60Hz
Power consumption	<1W
Sensitivity	5kΩ~100kΩ adjustable
Trip delay	2s
Supply indication	Green LED
Output indication	Red LED
Output contact	1C/0
Current rating	8A/250V AC1
Rated insulation voltage	415V
Protection degree	IP20
Pollution degree	3
Electrical life	10 ⁵
Mechanical life	10 ⁶
Altitude	≤2000m
Ambient temperature	-25℃~+50℃
Permissable relative humidity	≤50% at 40℃ (without condensation)
Storage temperature	-25℃~+75℃
Conductor size	0.5~2.5mm ²
Tightening torque	0.5Nm
Mounting	TH35 Rail (EN60715)

Front-face panel

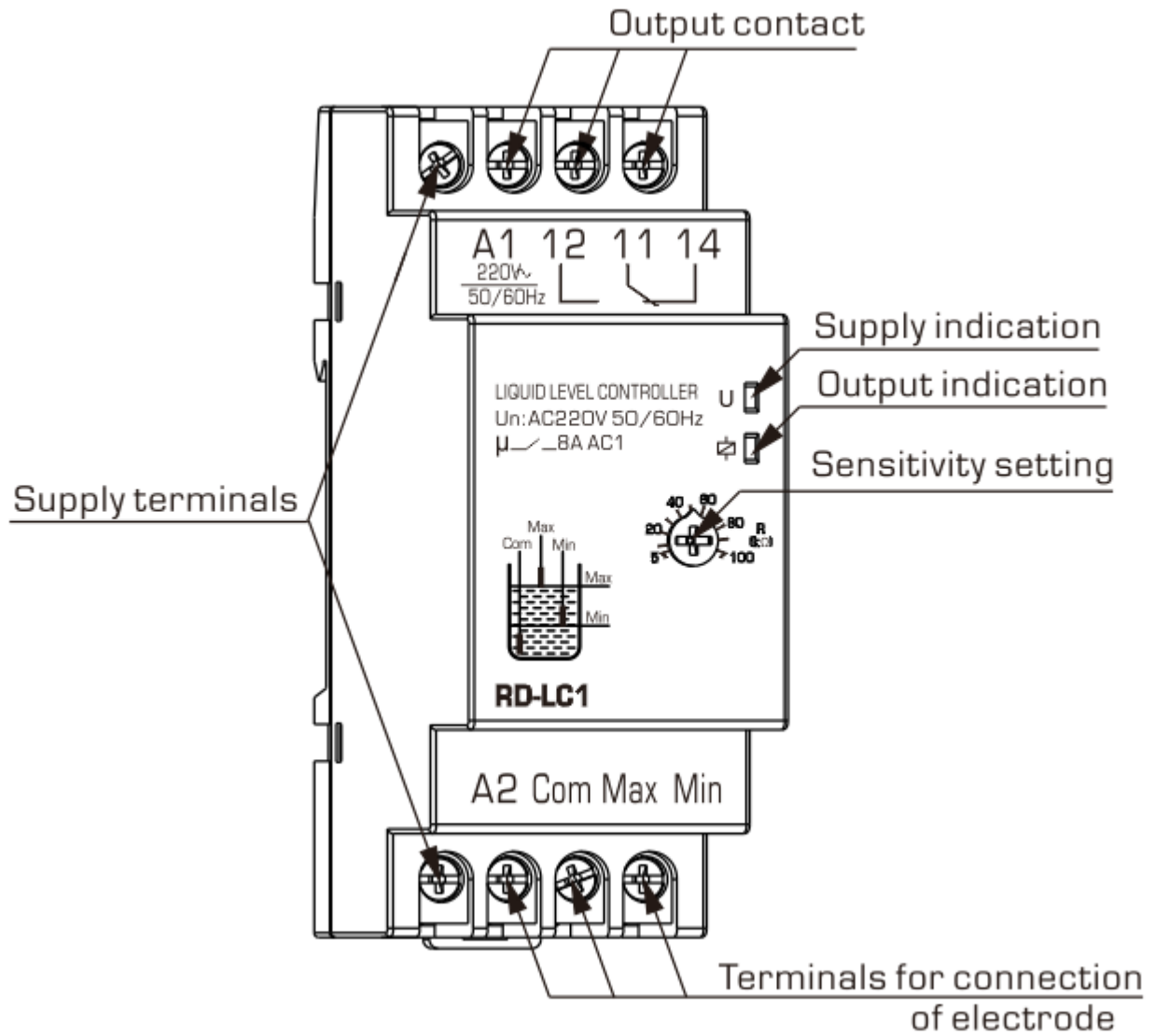

Function diagrams

- 3 electrodes mode

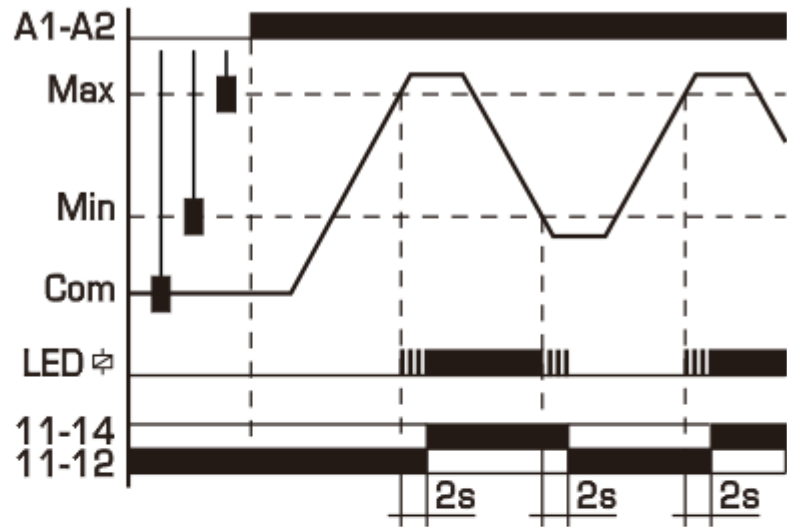

- 2 electrodes mode

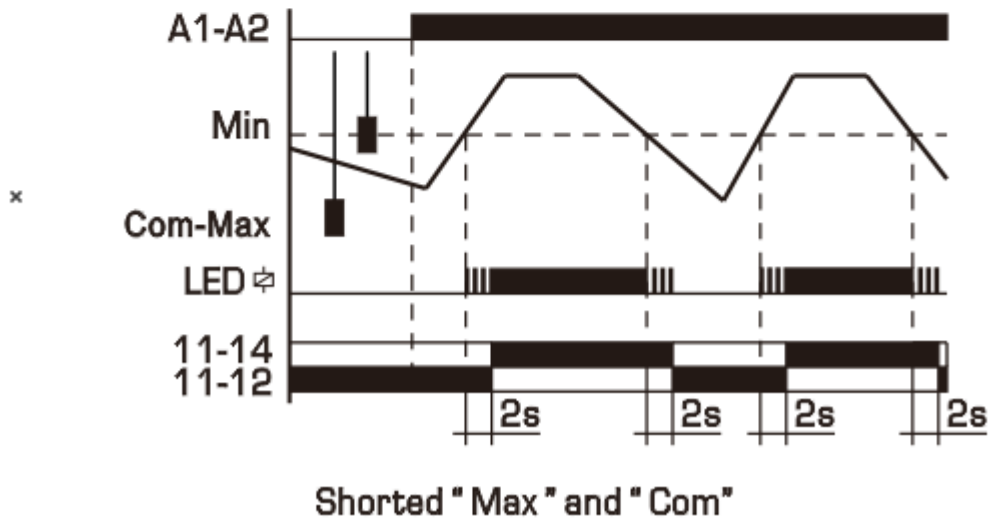

Symbol

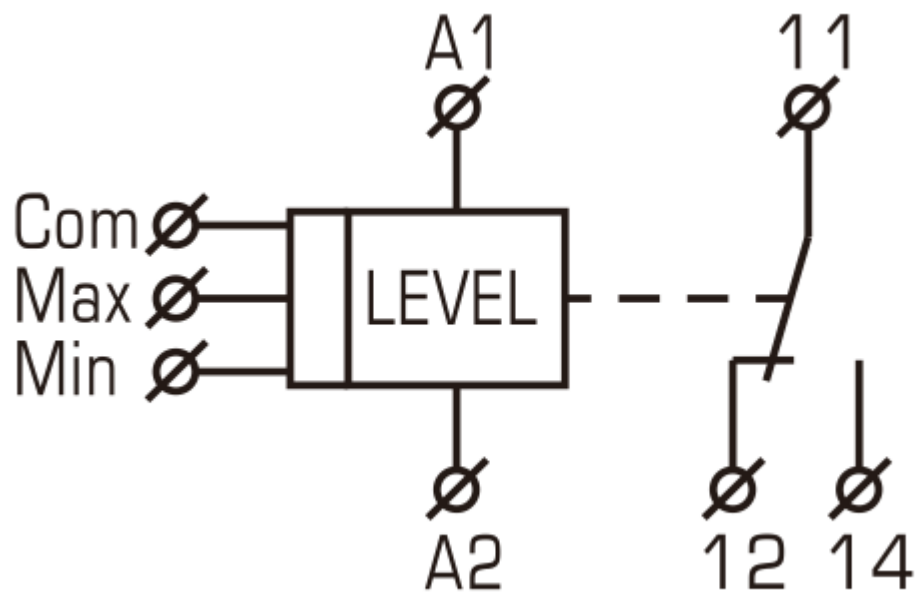

Wiring diagrams

● 3 electrodes mode(draining)

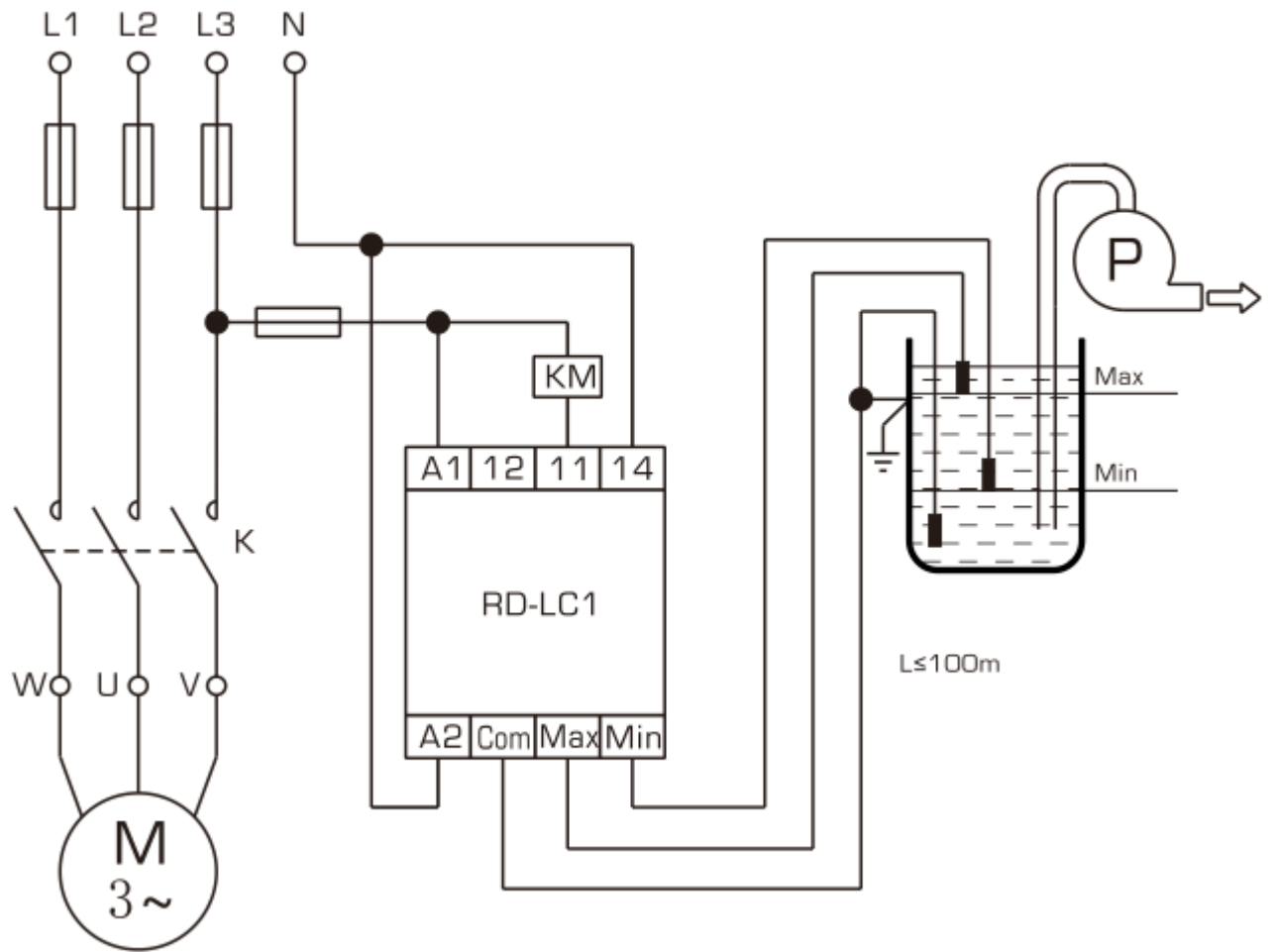

● 3 electrodes mode(filling)

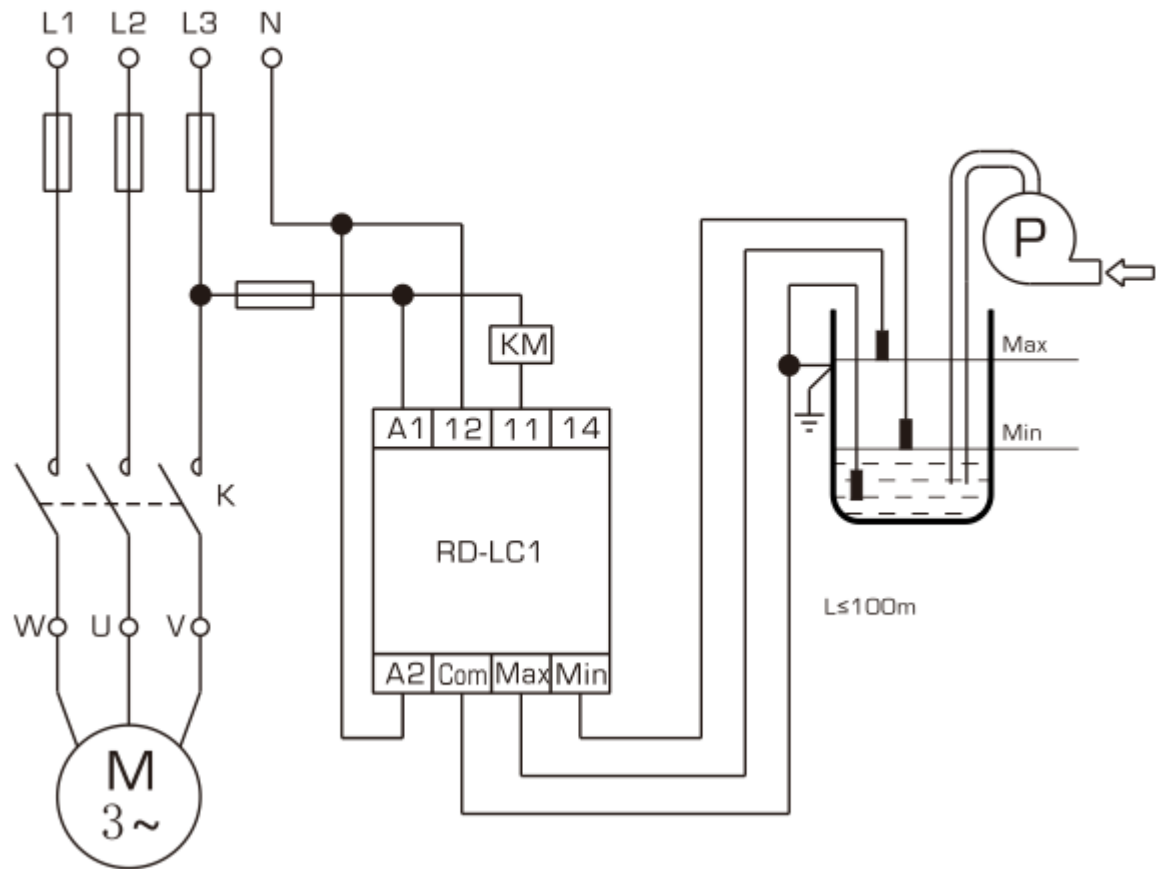

● 2 electrodes mode(draining)

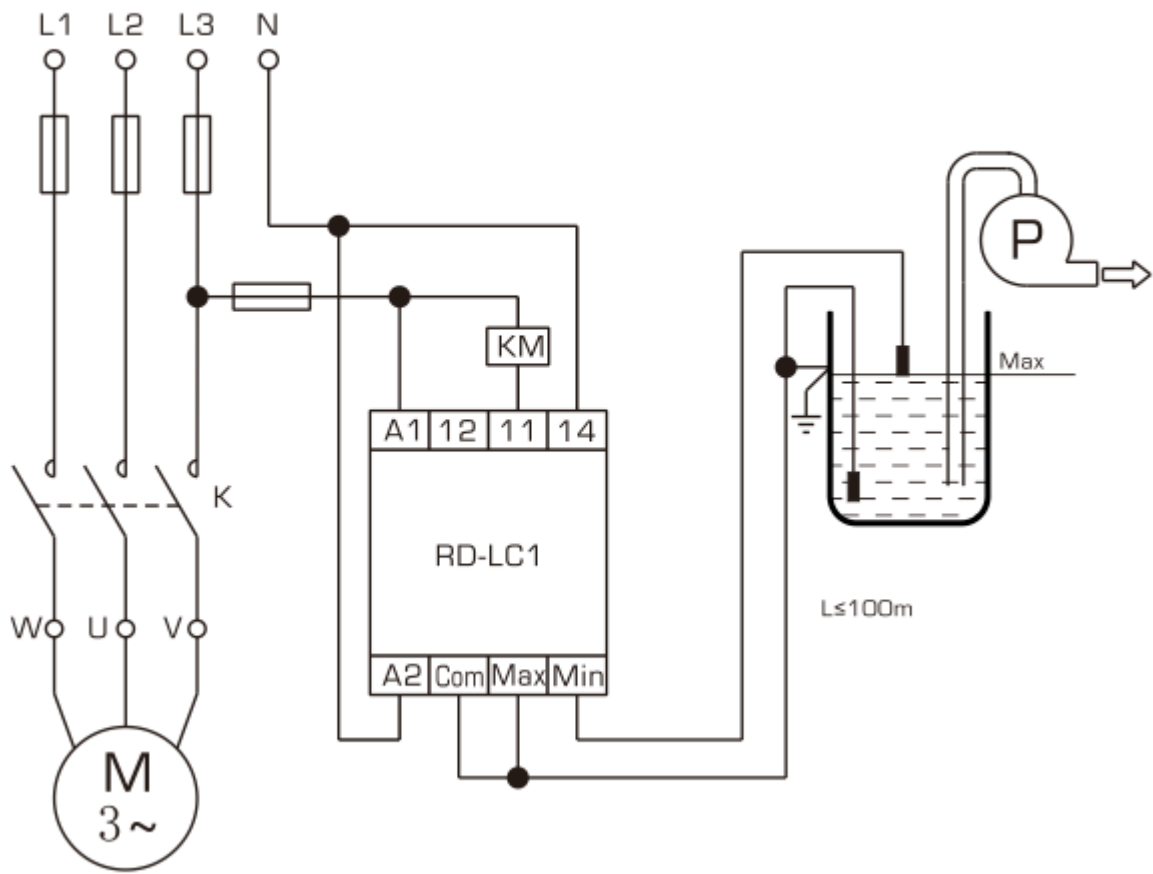

● 2 electrodes mode(filling)

