

www.janitza.com

Janitza electronics GmbH
 Vor dem Polstück 6
 D-35633 Lahnau
 Support Tel. 0049 6441 9642-22
 e-mail: info@janitza.com
 www.janitza.com

Power Analyser UMG 104

Operating manual and
 technical data

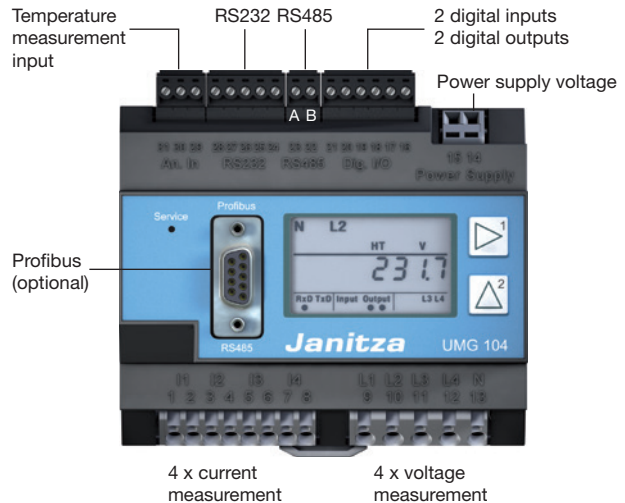

Janitza®

General Information	4	Installation	22
Protected trademarks	4	Installed position	22
Meaning of the symbols used	5	Power supply voltage	23
Inspection on receipt	6	Current measurement	24
Scope of supply	7	Ammeter	26
Available accessories	7	Direct measurement	28
Notes on Use	8	Voltage measurement	29
Product Description	10	Interfaces	32
Intended use	10	RS485	34
UMG104 features	11	RS485 profibus DP V0 slave	36
Methods of measurement	12	Digital inputs and outputs	38
Operating concept	12	Temperature measurement input	42
GridVis programming software	13	Putting into Service	43
Three-phase 4-wire systems	14	Applying the power supply voltage	43
Three-phase 3-wire systems	16	Frequency measurement	43
Use	18	Applying the measuring-circuit voltage	44
Key functions	18	Phase sequence	45
Concealed key (service)	18	Applying the measuring-circuit current	45
Display mode	19	Checking the energy measurement	46
Programming mode	20	Configuration	47
Display password	21	Current transformer ratio	47
		Current measurement connection options	48
		Voltage transformer ratio	49
		Voltage measurement connection options	50
		Interfaces	51
		RS232	51
		RS485	51
		Profibus (optional)	52
		Recordings	55

System information	56	Appendix	76
Overrange	56	Measured value displays	76
Serial number	57	Declaration of conformity	77
Date	57	Dimensioned drawings	78
Firmware release	57	UMG104 connection example	79
Time	57	Quick Reference Instructions	80
Service and maintenance	58		
Repair and calibration	58		
Front film	58		
Battery	58		
Firmware update	58		
Service	58		
Trouble shooting	59		
Technical specifications	62		
General information	62		
Ambient conditions during operation	62		
Transport and storage	62		
Power supply voltage	63		
Protection class	64		
Inputs and outputs	65		
Temperature measurement input	66		
Interfaces	67		
Measurement uncertainty	68		
Measuring inputs	70		
Voltage measurement	70		
Parameter list	72		

General Information

Protected trademarks

All trademarks and their resulting rights belong to the respective holders of these rights.

www.MATERIALEELECTRICE.ro
Consiliere specializata

Meaning of the symbols used

The following pictograms are used in this manual:



Dangerous voltage!

Danger or risk of severe injury. Disconnect the system and device from the power supply before starting the work.



Important!

Please note and follow the documentation. This symbol is intended to warn you of possible hazards that can occur during installation, starting up and use.



Note.



PE (protective earth) terminal.

www.MATERIALEELECTRICE.ro
Consiliere specializata

Inspection on receipt

Fault free and safe use of this device requires appropriate transport, proper storage, erection and assembly as well as careful operation and maintenance. If it can be assumed that safe operation is no longer possible, the device must be immediately taken out of service and secured against being accidentally started up.

The device must be unpacked and packed with the usual care, without the use of force and only using suitable tools. The devices must be visually inspected for perfect mechanical condition. Please also note and follow the installation instructions enclosed with the device.

It can be assumed that safe operation is no longer possible if the device, e.g.

- has visible damage,
- no longer works, despite intact mains power supply,
- has been exposed to unfavourable conditions (e.g. storage outside the permissible climatic limits without adjustment to the ambient climate, condensation, or similar) for a lengthy period or was exposed to unfavourable effects or loads during transport (e.g. fall from a large height even if there is no visible external damage, or similar).

Please check the scope of supply for completeness before you start installing the device.

www.MATERIALE.ELECTRICE.ro

Consiliere specializata



All screw-type terminals belonging to the scope of supply are plugged into the device.



The installation and start-up instructions also describe options which do not belong to the scope of supply.



All supplied options and design versions are described on the delivery note.

Scope of supply

Number	Product No.	Name
1	52 20 xxx ¹⁾	UMG104 XX ²⁾
1	33 03 083	Installation and start-up instructions.
1	10 01 807	Screw-type terminal, plug-in, 2 pin.
1	10 01 808	Screw-type terminal, plug-in, 3 pin.
1	10 01 809	Screw-type terminal, plug-in, 5 pin.
1	10 01 810	Screw-type terminal, plug-in, 6 pin.
1	52 00 008	RS485, external terminating resistor, 120 ohm

www.MATERIALEELECTRICE.ro

Consigliere specializata

1) Refer to delivery note for product number.

2) Design version.

Available accessories

Product No.	Name
21 01 058	Battery, lithium CR2032, 3V (according to UL1642)
08 02 427	RS232, Connection cable (UMG 104 – PC), 2m, 5 poles

Notes on Use

Please read these operating instructions and all other publications which have to be used to work with this product (in particular for installation, operation or maintenance).

Note and follow all safety instructions as well as any warnings. If you do not follow the instructions, personal injuries and/or damage to the product could be the result.

Any unauthorised change or use of this device which extends beyond the given mechanical, electrical or other operating limits can cause personal injuries and/or damage to the product.

Any such unauthorised change is “misuse” and/or “negligence” under the product's warranty and therefore excludes the warranty for cover of possible resulting injuries or damage.

This device may be solely operated and maintained by skilled persons.

Skilled persons are people who, on the basis of their relevant training and experience, are capable of identifying risks and avoiding possible hazards which operation or maintenance of the device can cause.

When using the device, any additional legal and safety regulations required for the respective use must be observed.

WWW.MATERIALEELECTRICE.ro
Consiliere specializata

**Important!**

If the device is not operated according to the instruction manual, protection is no longer ensured and the device can cause hazards.



Conductors made of individual wires must be fitted with wire end ferrules.



Only pluggable screw terminals with the same number of poles (pins) and of the same type may be plugged together.

www.UMG104.it **ELECTRICE** .ro
Consigliere specializzata

Product Description

Intended use

The UMG104 is intended to be used for the measurement and calculation of electrical variables such as voltage, current, energy, work, harmonic components, etc. in building installations, at distribution boards, circuit-breakers and busbar trunking systems.

Measuring-circuit voltages and currents must originate from the same system.

The UMG104 is permanently installed in control cabinets or small distribution boards. It can be installed in any position.

The measurement results can be displayed, stored and read out via serial interfaces and further processed.

The voltage measurement inputs are designed for measurements in low-voltage systems in which rated voltages up to 300 V conductor to earth and surge voltages of overvoltage category III can occur.

The current measurement inputs of the UMG104 are connected via external $\dots/1A$ or $\dots/5A$ current transformers.

Measurement in medium and high-voltage systems takes place with current and voltage transformers. Special safety requirements must be complied, which are not dealt with in any greater detail here.

The UMG104 fulfils the test requirements for use in industrial areas.

Mains failure detection

The mains failure detection takes place via the voltage measurement inputs. The selection of voltage measurement inputs can be configured using the GridVis software.

Mains failure stored energy time

The UMG104 bridges the following mains failures at the auxiliary voltage input:

Mains voltage	Stored energy time
230V AC	max 80ms

UMG104 features

- Measurement in IT, TN and TT systems,
- 4 voltage measurement inputs
- 4 current measurement inputs,
- Continuous scanning of the voltage and current measurement inputs,
- Energy measurement, measurement uncertainty class 0.5 for ..5A current transformers,
- Energy measurement, measurement uncertainty class 1 for ..1A current transformers,
- Registers more than 800 measured values (readings),
- Fourier analysis 1st to 40th harmonic component for U, I, P (consumption/supply) and Q (inductive/capacitive),
- 2 digital inputs,
- 2 digital outputs,
- Temperature measurement input,
- LC display, backlight (optional),
- 2 keys,
- Profibus DPV0 (optional),
- RS485 (modbus RTU),
- RS232,
- Operating temperature range -10°C .. +55°C,
- Mounting on top hat rails 35 mm,
- Suitable for installation in distribution boards,
- Suitable for measurements in networks with frequency inverters.

www.MATERIALEELECTRICE.ro
Consiliere specializata

Methods of measurement

The UMG104 measures continuously and calculates all effective values over a 200 ms interval.

Operating concept

You can program the UMG104 and call up measured values in several ways.

- **Directly** at the device using 2 keys and the display. You can change the values in the parameter list (see Appendix) and call up the measured values from the measured value displays.
- Via the **GridVis** programming software.
- Via the RS485 with the **modbus** protocol. You can change and call up data with the help of the modbus address list.

www.

MATERIAL ELECTRICITY TO

Operation of the UMG104 via the integrated display and the two keys only is described in these operating instructions.

The GridVis programming software and the homepage have their own “online help”.



Use the **parameter list** in the appendix to these instructions for programming at the UMG104 and the **modbus address list** (Download: www.janitza.de) for programming via a serial interface.

GridVis programming software

The UMG104 can be programmed and read out using the GridVis® programming software (Download: www.janitza.de). This requires a PC to be connected to the UMG104 via a serial interface.

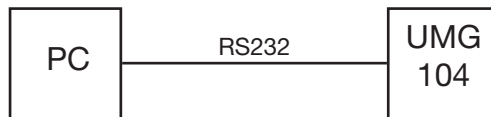

Fig. 13.1 Connection of a UMG104 to a PC via an RS232 cable.

GridVis features

- Programming the UMG104
- Configuring recordings
- Reading out recordings.
- Storing data in a database
- Graphic display of measured values
- Programming customer-specific applications.

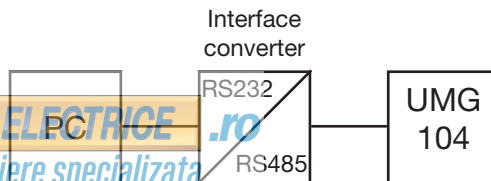

Fig. 13.2 Connection of a UMG104 to a PC via an interface converter.

Three-phase 4-wire systems

The UMG104 can be used in three-phase 4 conductor systems (TN, TT system) (50 Hz, 60 Hz) with earthed PEN conductor. The bodies of the electrical system are earthed.

The conductor to neutral conductor voltage may not exceed 300 V AC.

The UMG104 is only suitable for environments in which the impulse voltage withstand level of 4 kV (overvoltage category III) is not exceeded.

U_{L-N} / U_{L-L}
66 V / 115 V
120 V / 208 V
127 V / 220 V
220 V / 380 V
230 V / 400 V
240 V / 415 V
260 V / 440 V
277 V / 480 V

Maximum rated voltage
of the grid

www.MATERIALEELETTRICO.it
Consigliere specializzata

Fig. 14.1 Table of rated voltages of the grid suitable for the voltage inputs.

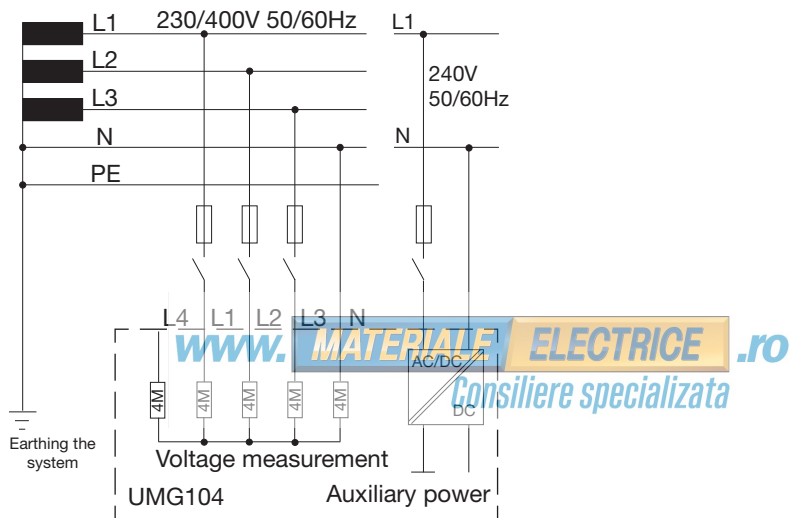

Fig. 15.1 Block diagram, UMG104 in TN system.

Three-phase 3-wire systems

The UMG104 can be used in unearthed three-phase 3 wire systems (IT system). The conductor to conductor voltage may not exceed 480V AC (50 Hz, 60 Hz).

The UMG104 is only suitable for environments in which the impulse voltage withstand level of 4 kV (overvoltage category III) is not exceeded.

In the IT system the neutral point (star point) of the voltage generator is not earthed. The bodies of the electrical system are earthed. Earthing via high-resistance impedance is allowed.

IT systems are only allowed in certain systems with their own transformer or generator.

U_{L-L}
66 V
115 V
120 V
127 V
200 V
230 V
240 V
260 V
277 V
347 V
280 V
400 V
415 V
440 V
480 V

Maximum rated voltage
of the grid

Fig. 16.1 Table of rated voltages of the grid suitable for the voltage inputs.

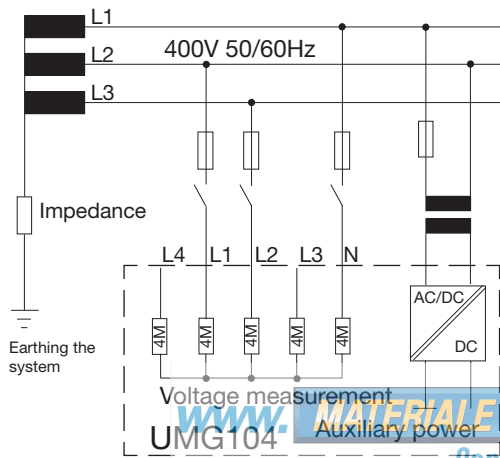

Fig.17.1 Block diagram, UMG104 in IT system without N.

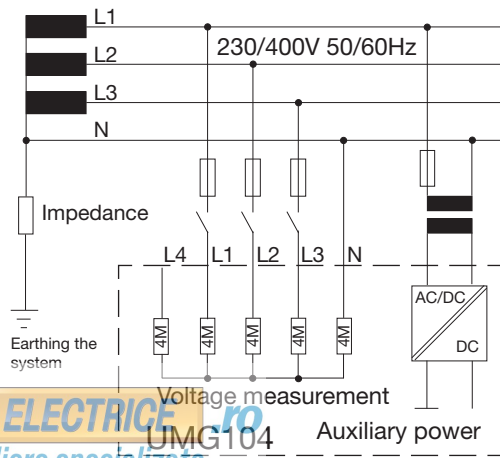

Fig.17.2 Block diagram, UMG104 in IT system with N.

WWW.MATERIALEELETTRICO.IT
Consigliere specializzata

Use

The UMG104 has a display, keys 1 and 2 and the Service key to make it easier to install and start up the UMG104 without a PC.

Important parameters such as current transformers and device address are included in the parameter list (see Appendix) and can be directly programmed at the device.

A differentiation is made between operation with the

- display mode and
- Programming mode.

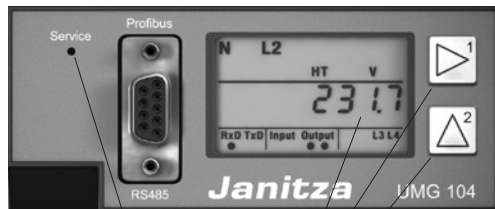

Display
Key 1
Key 2
Concealed key

Key functions

Press the key “briefly”:

- page forwards
- Digit/value +1

Press the key for “long time”:

- page backwards
- Digit/value -1

Simultaneously press both keys for around 1 second and keep them pressed:

- Switch between display mode and programming mode.

www.MATERIALEELETTRICE.ro



The UMG104 is operated using keys 1 and 2.

Concealed key (service)

The Service key is intended for use by instructed service employees only.

Display mode

After the power supply is resumed the device is in Display mode.

In Display mode you can use Keys 1 and 2 to page between the measured value displays.



Use Key 1 to select the phase for the measured values.



Press Key 2 to page between the measured values for current, voltage, power output, etc.

The factory default setting for the measured value displays is shown in the “measured value displays” in the Appendix.



Important!

The user can use the GridVis/Jasic to reconfigure the function of the keys and selection of the values to be displayed.

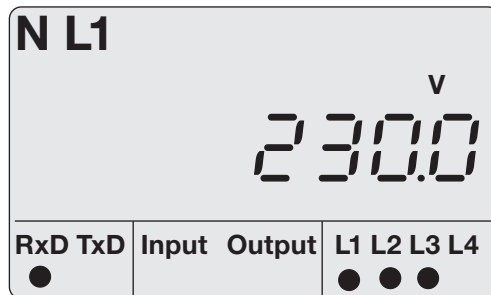

Fig. 19.1 “Display Mode” display example.
Displayed measured value: $U_{L1-N} = 230.0$ V.

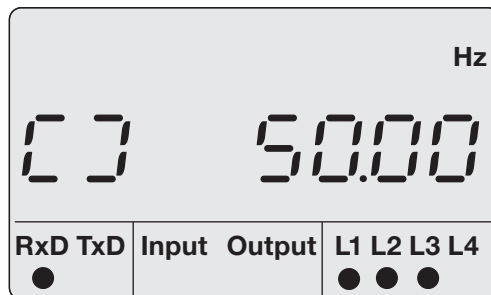

Fig. 19.2 Display example for rotating field and frequency.

Programming mode

The most important settings required for operation of the UMG104 can be displayed and changed in programming mode.

The parameter list in the Appendix contains the addresses for the most important settings. You can make further settings using the GridVis software.

If you simultaneously press Keys 1 and 2 for around 1 second, programming mode opens via a password query. If a display password has not been programmed, the first programming menu opens directly.

Programming mode is denoted in the display by the text “PRG”. The digits of the address flash.

If you are in programming mode and have not pressed a key for approximately 60 seconds or simultaneously press Keys 1 and 2 for around 1 second, the device returns to display mode.

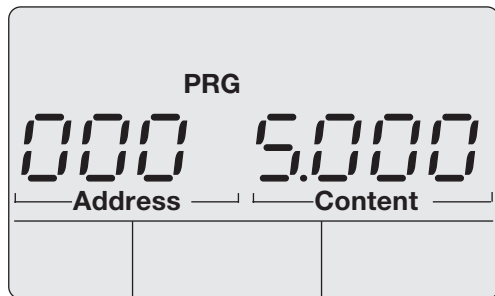

Fig. 20.1 “Programming Mode” display example, address 000 with content 5,000.

WWW.MATERIALEELECTRICE.IT

Consigliere specializzata

Display password

You can program a 4-digit display password to make it difficult to accidentally change the programming data directly at the device. A display password is not set in the factory.

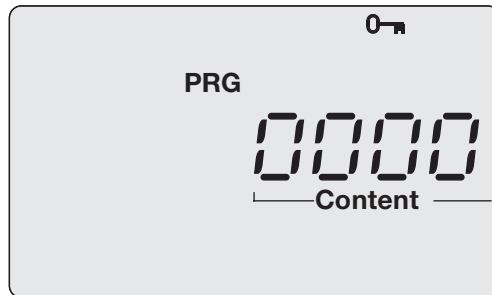

Fig. 21.1 Query window for the display password.

www. **MATERIALE** **ELECTRICE** .ro
Consiliere specializata

Addr.	Content
500	Display password 0 =the password is not queried.

Fig.21.2 Section of the parameter list for password programming.

Installation

Installed position

The UMG104 can be installed in control cabinets or in small distribution boards according to DIN 43880. It is mounted on a 35 mm mounting v according to DIN EN 60715. It can be installed in any position.

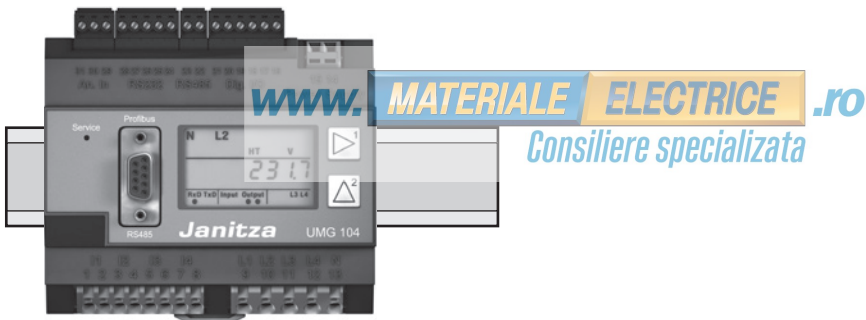

Fig. 22.1 UMG104 on mounting rail according to DIN EN 60715.

Power supply voltage

A power supply voltage is required for operation of the UMG104. The type and amount of power supply voltage required is noted on the rating plate.

Before applying the power supply voltage, ensure that the voltage and frequency match the information given on the rating plate!

The connection cables for the power supply voltage must be fused with a UL listed fuse (6A type C).

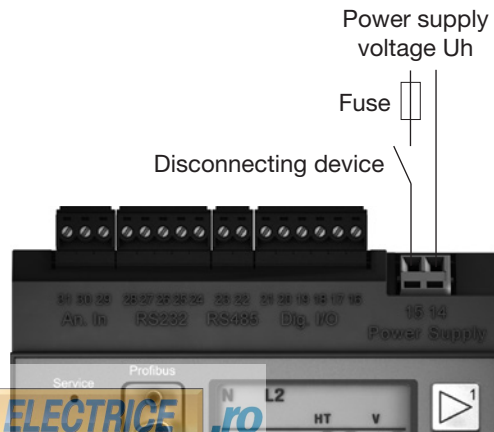

Fig. 22.1 Connection example for the power supply voltage U_h .



- A disconnecter or circuit-breaker must be provided for the power supply voltage in the building installation.
- The disconnecter must be installed near the device and must be easy for the user to reach.
- The switch must be labelled as a disconnecting device for this device.
- Voltages which are above the allowable voltage range can destroy the device.



Devices driven with direct current are protected against polarity reversal.



Important!

The inputs for the supply voltage are dangerous to touch!

www.MATERIALEELECTRICE.ro

Consiliere specializata

Current measurement

The UMG104 is designed for the connection of current transformers with secondary currents of $.1A$ and $.5A$. Only alternating currents, not direct currents, can be measured.

Each current measurement input can be permanently loaded with 6A or for 1 second with 100 A.

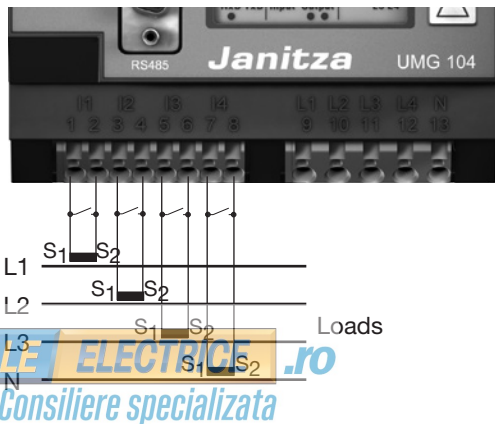

Attention!

The current inputs are live.



Important!

The UMG104 is not suitable for the measurement of direct voltages.



Earthing current transformers

If a connection is provided for earthing the secondary winding, this must be connected with earth.



For the inputs L4 and I4 are no connection schemes required.

Fig. 24.1 Connection example, current measurement via current transformers.

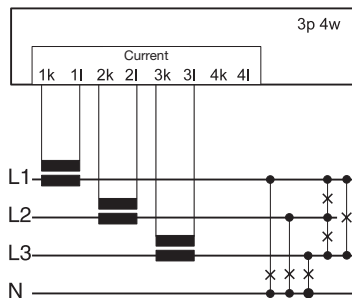

Fig. Current measurement, connection example for connection option 0, see page 50.

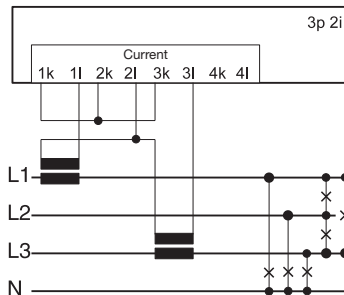

Fig. Current measurement, connection example for connection option 0, see page 50.

WWW.MATERIALEELECTRICE.IT
Consigliere specializzata

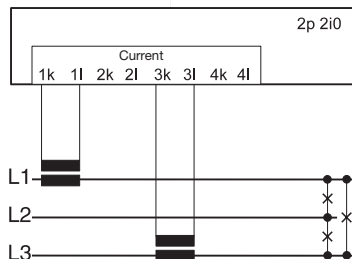

Fig. Current measurement, connection example for connection option 1, see page 50.

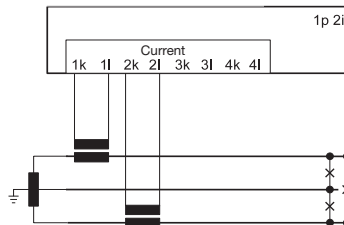

Fig. Current measurement, connection example for connection option 0, see page 50.

Ammeter

If you not only want to measure the current with the UMG104 but with an ammeter also, the ammeter must be connected in series to the UMG104.

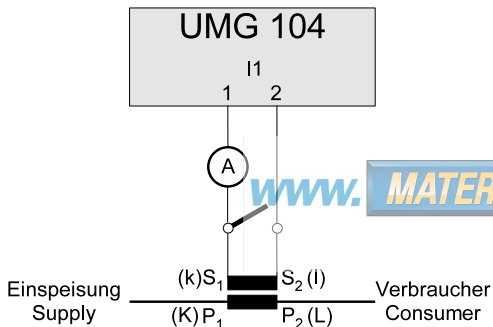

Fig. 26.1 Example, current measurement via additional ammeter.



Short-circuit current transformer connections!

The secondary connections of the current transformer must be short-circuited to them first before the current supply leads to the UMG104 are disconnected!

If a testing switch is available, which automatically short circuits the current transformer's secondary leads, it is sufficient to place this in the "test" position, provided the short-circuiters have been tested first.

www.MATERIALEELECTRICE.IT
Consigliere specializzata



Open current transformer!

High hazardous live voltage peaks can occur at current transformers which are operated open on the secondary side!

The winding insulation in "safe open current transformers" is dimensioned so that the current transformers can be operated open. But these current transformers are also hazardous live if they are operated open.

Summation current measurement

If the current is measured via two current transformers, the total transformation ratio of the current transformers must be programmed in the UMG104.

Example

The current is measured via two current transformers. Both current transformers have a transformation ratio of 1000/5A. The summation measurement is performed with a 5+5/5A summation current transformer.

The UMG104 must then be set as follows:

Primary current: $1000A + 1000A = 2000A$
 Secondary current: $5A$

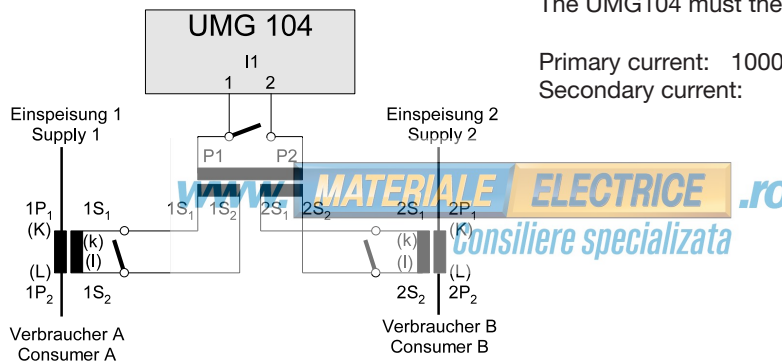

Fig. 27.1 Example, current measurement via summation current transformers.

Direct measurement

Nominal currents up to 5 A can also be measured directly with the UMG104. In this case it must be noted that each current measurement input may be loaded continuously with 6 A or for 1 second with max 100 A.

As the UMG104 does not have any integrated protection for the current measurement, this protection (e.g. 6A fuse type C) must be provided for during installation.

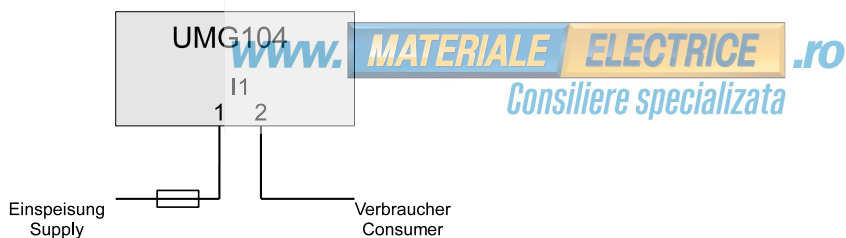

Fig. 28.1 Example, direct current measurement.

Voltage measurement

The UMG104 is designed for the measurement of alternating voltages in 300 V systems in which category III overvoltages can occur.

The UMG104 can only determine exact measured values if a measurement-current voltage greater than 10 Veff is applied to the voltage measurement input L1.

The following must be noted when selecting the instrument leads for the voltage measurement:

- The instrument leads required for the voltage measurement must be suitable for voltages up to 300 VAC to earth and 520 VAC conductor to conductor.
- Normal instrument leads must be fused by an overcurrent protective device and routed via disconnectors.
- Short-circuit proof instrument leads must be routed via disconnectors only.

Overcurrent protective devices and disconnectors must be positioned near the device and must be easy for the user to reach.



For the inputs L4 and I4 are no connection schemes required.

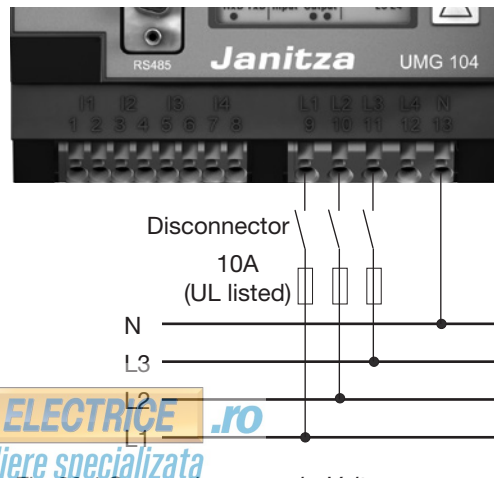

Fig. 30.1 Connection example: Voltage measurement via short-circuit proof instrument leads.



Important!
The voltage measurement inputs are hazardous live!



Important!
The UMG104 can only determine exact measured values if a measurement-current voltage greater than 10 Veff is applied to the voltage measurement input L1.

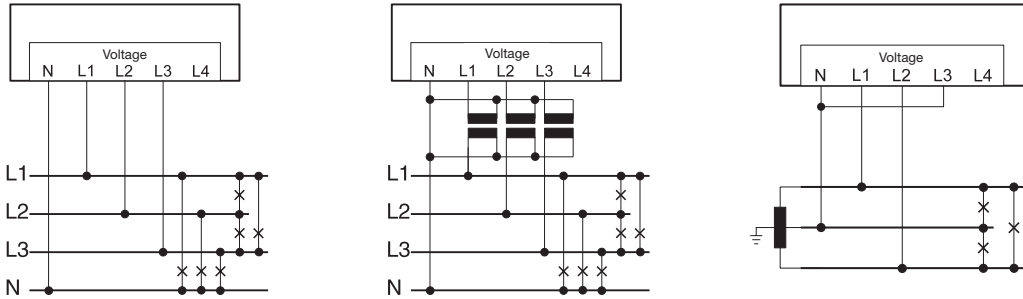

Fig. 31.1 Connection examples for voltage measurement in “three-phase 4-conductor systems”.
(Connection option 0, see page 51)

www.MATERIALEELECTRICE.ro
Consiliere specializata

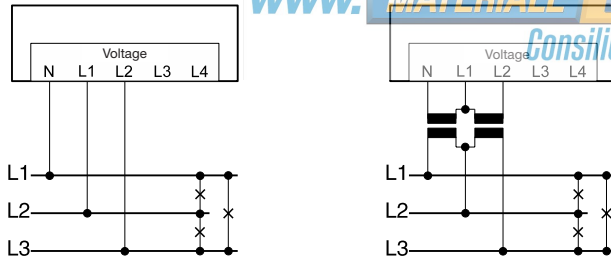

Fig. 31.2 Connection examples for voltage measurement in “three-phase 3-conductor systems”.
(Connection option 1, see page 51)



Measuring-circuit voltages and currents must originate from the same system.



Important!
Voltages above 300 VAC to earth must be connected via voltage transformers.

Auxiliary measurement, input 4

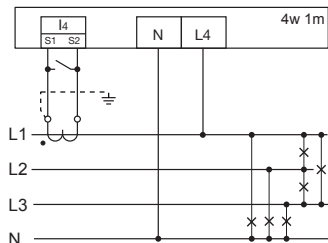

Fig. measurement using a three-phase 4 conductor network with symmetrical load.

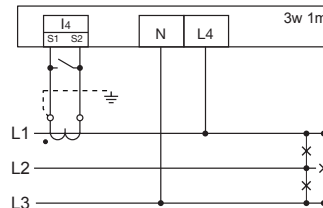

Fig. measurement in a three-phase 3 conductor network with symmetrical load.

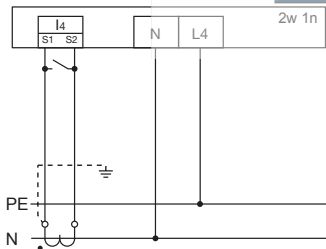

Fig. measurement of the voltage between N and PE. Measurement of the current in the neutral wire.

WWW.MATERIALELECTRICE.ro

Consiliere specializata



In case of a three wire main measurement (input V1-V3), the auxiliary measurement (input V4) cannot be used as measuring input.



For measurement with the auxiliary measurement (V4), a voltage must be connected to the baseline measurement for frequency determination.

Interfaces

RS232

You can use the connection cable (available accessories) to connect the UMG104 to a PC. The achievable distance between two devices with RS232 interface depends on the cable used and the baud rate. The maximum connectable cable length is 30 m!

As a guideline value, for a transmission rate of 9600 baud the distance should not exceed 15 m to 30 m.

The permissible ohmic load must be larger than 3 kohm and the capacitive load caused by the transmission cable must be smaller than 2500 pF.

Shielding

A twisted-conductor and shielded cable must be provided for connections via the RS232 interface. The shielding at both ends of the cable must be connected to a large area of the housing or cabinet parts in order to achieve an adequate shielding effect.

www.MATERIALEELECTRICE.ro
Consiliere specializata



Important!

Profibus, RS232, RS485 and temperature measurement input are not metallicly separated from each other.



All interfaces can be used simultaneously.

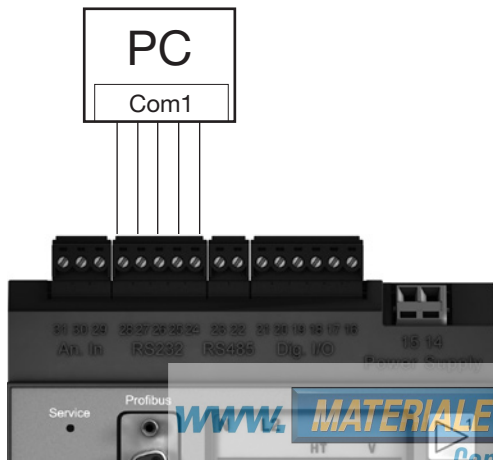

Fig. 33.1 Example, connecting a UMG104 to a PC via the RS232 interface.

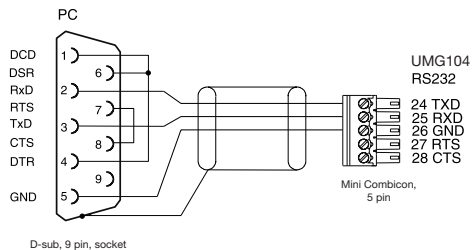

Fig. 33.2 Connector pin assignment for the PC connection cable (Part number: 08 02 427).

www.MATERIALEELECTRICE.ro
Consiliere specializata

RS485

Bus structure

All devices are connected in a bus structure (line). Up to 32 stations can be connected together in a segment. The cable at the start and end of a segment is terminated with resistors.



If there are more than 32 stations, repeaters must be used to connect the individual segments.

Terminating resistors

The cable at the start and end of a segment is terminated with resistors (120 ohm, 1/4 W).

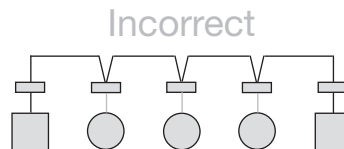
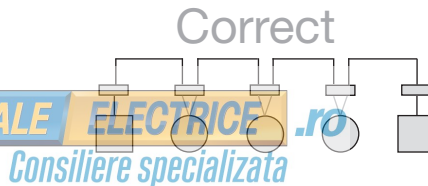
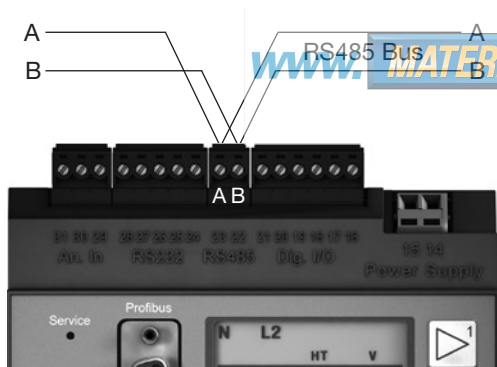
The UMG104 does not contain any terminating resistors.



-  Terminal strip in the control cabinet.
-  Device with RS485 interface.
(Without terminating resistor)
-  Device with RS485 interface.
(With terminating resistor at the device)

Shielding

A twisted-conductor and shielded cable must be provided for connections via the RS485 interface. The shielding at both ends of the cable must be connected to a large area of the mounting plate or cabinet parts in order to achieve an adequate shielding effect.

Cable type

Recommended cable types:

Unitronic Li2YCY(TP) 2x2x0.22 (Lapp cables)

Unitronic BUS L2/FIP 1x2x0.64 (Lapp cables)

Cable length

1200 m for a baud rate of 38.4 k

www.MATERIALEELECTRICE.ro
Consiliere specializata



For the wiring of the Modbus connection, CAT cables are not suitable. Please use the recommended cables.



Important!
Profibus, RS232, RS485 and temperature measurement input are not metallically separated from each other.

RS485 profibus DP V0 slave

The profibus connection in the UMG104 is a 9 pin DSUB socket.

We recommend use of a 9 pin profibus connector for the connection, e.g. as made by Phoenix, type "SUBCON-Plus-ProfIB/AX/SC" with product number 2744380. (Janitza art. no.: 13.120.539)

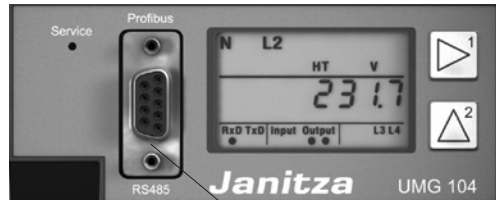

— Profibus connection

Fig. 36.1 UMG104 with profibus interface.

www.MATERIALEELECTRICE.ro
Consiliere specializata

Connecting the bus cables

The incoming bus cable is connected to terminals 1A and 1B. The bus cable for the next device in the line is connected to terminals 2A and 2B. If there is not another device in the line the bus cable must be terminated with resistors (switch set to ON).

In the ON switch setting terminals 2A and 2B are switched off for the continuing bus cable.

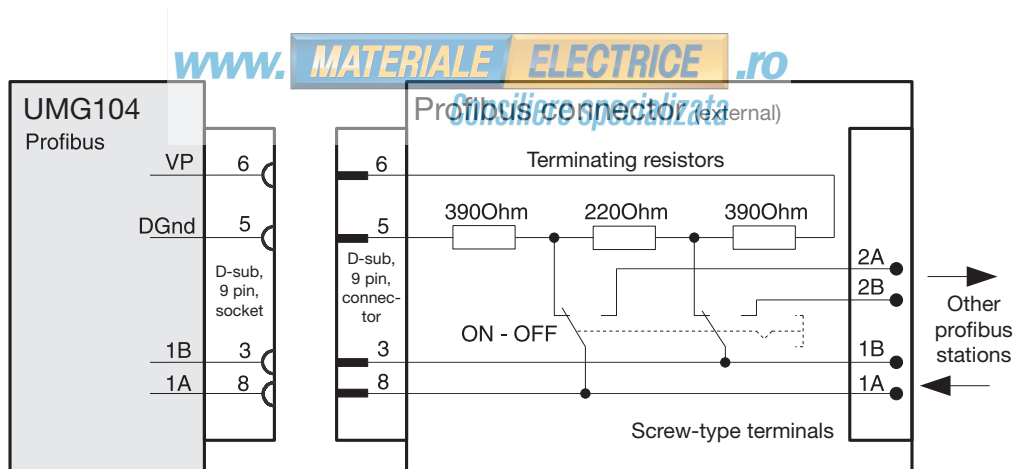

Fig. 37.1 Profibus connector with terminating resistors.

Digital inputs and outputs

Digital outputs

The UMG104 has 2 transistor switching outputs. These outputs are metalically separated from the analysis electronics via optocouplers.

- The digital outputs can switch direct or alternating current load.
- The digital outputs can switch loads independant on the polarity of the feeding voltage.
- The digital outputs are not short-circuit-proof.
- Cables, which are longer but 30m must be shielded.

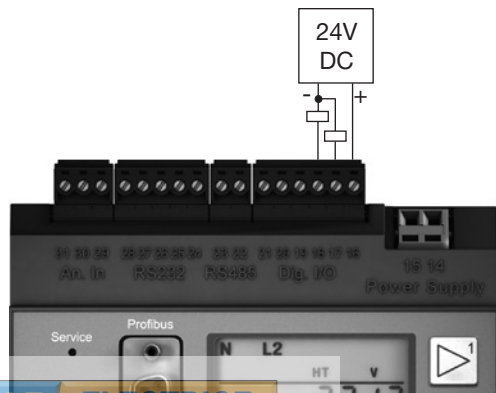

Fig. 38.1 Connection example.
Consiliere specializata



Attention!
The digital outputs are not short-circuit-proof.

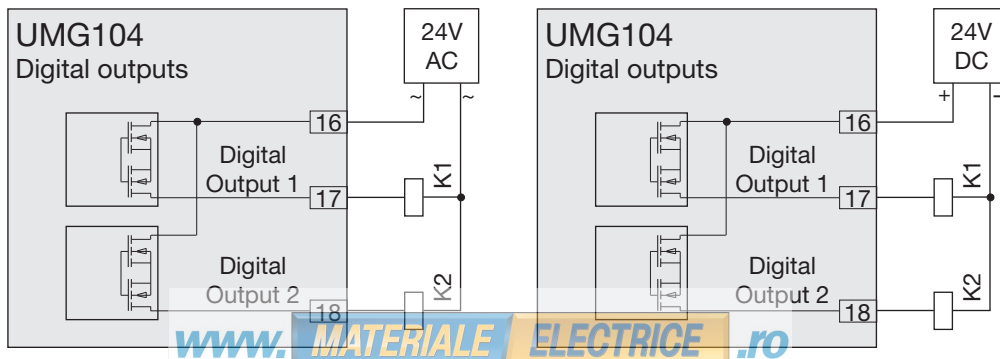

Fig. 39.1 Connection of alternating voltage relays to the digital outputs.

Fig. 39.2 Connection of direct current relays to the digital outputs.

Digital inputs

The UMG104 has 2 digital inputs to each of which you can connect one transducer.

An input signal is detected at a digital input if a voltage of at least 10 V and maximum 28 V is applied. In this case a current of at least 1 mA and maximum 6 mA flows. Cables longer than 30 m must be laid with shielding. Please mind the polarity of the feeding voltage.

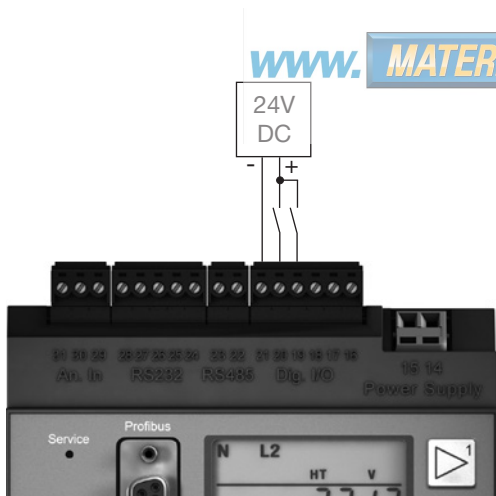

Fig. 40.1 Connection example.

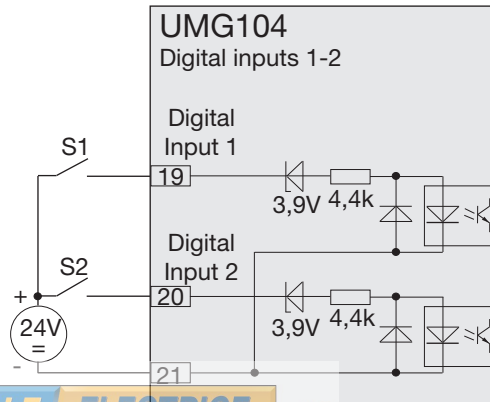

Fig. 40.2 Example for the connection of external switching contacts S1 and S2 to the digital inputs 1 and 2.



Attention!
The polarity of the feeding voltage must be respected for the digital inputs.

S0 pulse input

At each UMG104 with inputs for 24 V you can also connect S0 pulse generators according to DIN EN 62053-31.

You require only one external auxiliary voltage of 20..28 V DC and one external 1.5 kohm resistor each.

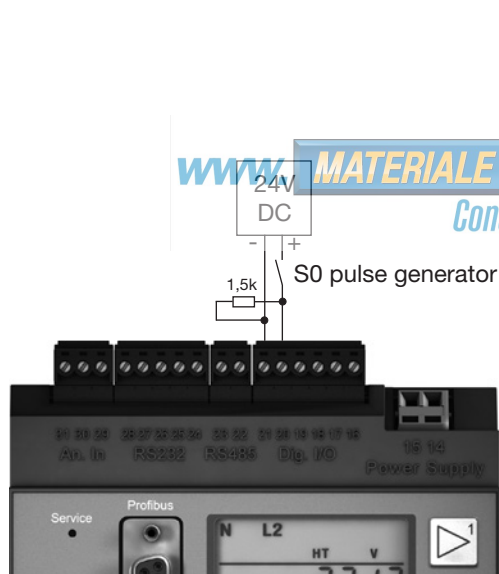

Fig. 41.1 UMG104 with inputs for 24 V. Example with S0 pulse generator.

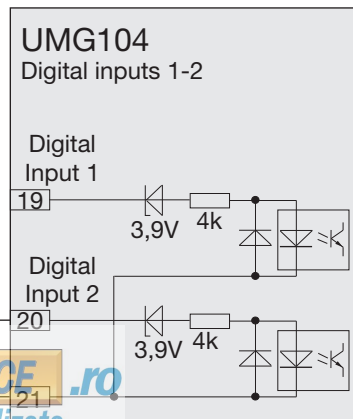
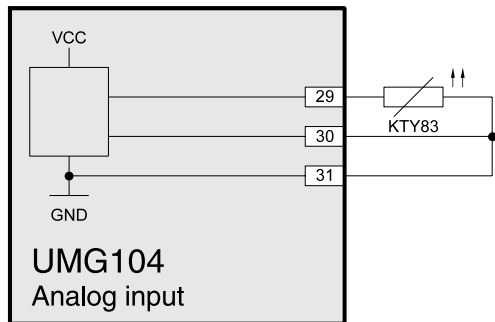

Fig. 40.2 UMG104 with inputs for 24 V. Example for connection of an S0 pulse generator at digital input 2.

Temperature measurement input

Following temperature sensors can be connected to the temperature measurement input

- KTY83
- KTY84
- PT100
- PT1000



www.MATERIALS-ELECTRICE.ro Fig. 42.1 Example, temperature measurement with a KTY83.
Consiliere specializata

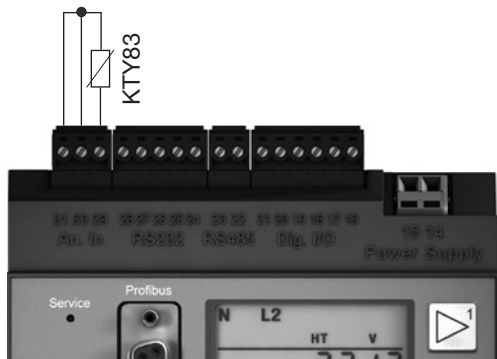

Use a shielded cable to connect the temperature sensor.



Important!
Profibus, RS232, RS485 and temperature measurement input are not metallically separated from each other.

Putting into Service

Applying the power supply voltage

The power supply voltage level for the UMG104 is given on the rating plate. Supply voltages which do not correspond to those given on the rating plate can result in malfunctions and destruction of the device.

After applying the power supply voltage the text “Start up” appears in the display. Around 2-6 seconds later the UMG104 switches to the first measured value display.

If no display appears, check whether the power supply voltage is within the rated voltage range.

Frequency measurement

For the frequency measurement, the measured voltage must be greater than 10 V in the voltage measuring path L1-N.

Only detected frequencies within the range 45 Hz to 65 Hz are used for measurement at the current and voltage measurement inputs.

www.electrice.ro
ELECTRICE .ro
Consiliere specializata



Prior to commissioning potential production dependant contents of the energy counter, min/max values and records have to be deleted.

Power supply voltage
(see rating plate)



Applying the measuring-circuit voltage

The UMG104 is suitable for the measurement of voltages of up to 300 V AC to earth and 520 V AC conductor to conductor.

The UMG104 is not suitable for the measurement of direct voltages. Voltages above 300 VAC to earth must be connected via voltage transformers.

After connecting the measurement-current voltages, the measured values displayed by the UMG104 for the L-N and L-L voltages must correspond to those at the voltage measurement input.

If a voltage transformer factor is programmed, this must be taken into account in the comparison.

Minimum voltage

A measuring-circuit voltage greater than 10 Veff must be applied to at least one of the voltage measurement inputs. If an adequately high measuring-circuit voltage is not applied on the measuring input V1 the UMG104 cannot determine exactly the system frequency and can therefore also not take an exact measurement.

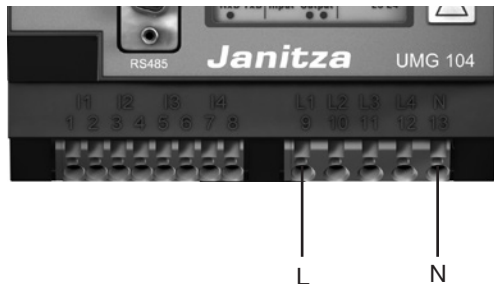

At least one phase (L) and the neutral conductor (N) must be connected to the voltage measurement input for the measurement.

Consigliere specializata

Phase sequence

Check the direction of the voltage rotating field in the measured value display of the UMG104. A “right” rotating field usually exists.

Applying the measuring-circuit current

The UMG104 is designed for the connection of $\dots/1A$ and $\dots/5A$ current transformers. Only alternating currents, not direct currents, can be measured via the current measurement inputs.

Short-circuit all current transformer outputs except one. Compare the currents displayed by the UMG104 with the applied current.

Taking into account the current transformer transformation ratio, the current displayed by the UMG104 must correspond to the input current.

The UMG104 must display approximately zero Amperes in the short-circuited current measurement inputs.

The current transformer ratio is set to $5/5A$ in the factory and if necessary must be adapted to the current transformer used.

Checking the energy measurement

Short-circuit all current transformer outputs except for one and check the displayed power outputs.

The UMG104 may only display one power output in the phase with a non short-circuited current transformer input. If this is not the case, check the connection of the measuring-circuit voltage and the measuring-circuit current.

If the power output amount is correct but the sign of the power output is negative, S1(k) and S2(l) could be inverted at the current transformer or they supply active energy back into the network.

www.MATERIALE-ELECTRICE.ro
Consiliere specializata

Configuration

Current transformer ratio

You can assign each of the 4 current transformer inputs its own current transformer ratio. A current transformer ratio of 5 A/5 A is programmed in the factory for all 4 current transformer inputs.

You can program current transformers with the same current transformer ratios in addresses 000 and 001. Program current transformers with different current transformer ratios in addresses 010 to 041.

A change in current transformer values in address 000 or 001 overwrites the contents of addresses 010 to 041 with the current transformer values from addresses 000 and 001.

A change in current transformer values in one of the addresses 010 to 041 deletes the current transformer values in addresses 000 and 001.

Address	Current transformer values
000	L1 L2 L3 L4 (primary)
001	L1 L2 L3 L4 (secondary)
010	L1 (primary)
011	L1 (secondary)
020	L2 (primary)
021	L2 (secondary)
030	L3 (primary)
031	L3 (secondary)
040	L4 (primary)
041	L4 (secondary)

Fig. 48.1 Section of the parameter list for the current transformer values.

Current measurement connection options

The UMG104 recognises two connection options for the current measurement.

Connection option 0

- Measurement via 3 current transformers in three-phase 4-conductor systems.
- Measurement via 2 current transformers in systems with the same load.
- Measurement in one-phase-3-conductor systems.

Connection option 1

- Measurement via 2 current transformers (Aron circuit) in three-phase 3-conductor systems.

Address	Connection option
110	0 = Three current transformers. (Default factory setting)
	1 = Two current transformers (Aron circuit)

Fig. 49.1 Section of the parameter list for the current transformer connection options.

www.MATERIALEELETTRICE.ro
Consiliere specializata



For the inputs L4 and I4 are no connection schemes required.

Voltage transformer ratio

You can assign each of the 4 voltage transformer inputs its own voltage transformer ratio.

A voltage transformer ratio of 400 V/400 V direct measurement is programmed in the factory for all 4 voltage transformer inputs.

You can program voltage transformers with the same voltage transformer ratios in addresses 002 and 003. Program voltage transformers with different voltage transformer ratios in addresses 012 to 043.

A change in voltage transformer values in address 002 or 003 overwrites the contents of addresses 012 to 043 with the voltage transformer values from addresses 002 and 003.

Address	Voltage transformer values
002	L1 L2 L3 L4 (primary)
003	L1 L2 L3 L4 (secondary)
012	L1 (primary)
013	L1 (secondary)
022	L2 (primary)
023	L2 (secondary)
032	L3 (primary)
033	L3 (secondary)
042	L4 (primary)
043	L4 (secondary)

Fig. 504 Section of the parameter list for the voltage transformer values.

Voltage measurement connection options

The UMG104 recognises two connection options for the voltage measurement.

Connection option 0

- Direct measurement of the voltage in 3-phase 4-conductor systems.
- Measurement via 3 voltage transformers in 3-phase 4-conductor systems.
- Measurement in one-phase-3-conductor systems.

Address	Connection option
111	0 = Three-phase 4-conductor systems (default factory setting) 1 = three-phase 3-conductor systems

Fig. 51.1 Section of the parameter list for the voltage transformer connection options.

Connection option 1

- Direct measurement of the voltage in three-phase 3-conductor systems.
- Measurement via 2 voltage transformers (Aron circuit) in three-phase 3-conductor systems.

www.MATERIALEELETTRICE.IT
Consigliere specializzata



For the inputs L4 and I4 are no connection schemes required.

Interfaces

The UMG104 has 4 serial interfaces:

- RS485
- RS232
- Profibus (optional)

All interfaces can be used simultaneously.

RS232

The following data must be programmed for use of the RS232 interface:

- Baud rate,
- Operating mode.

Refer to the parameter list in the Appendix for the default factory setting and the setting ranges.

RS485

The following data must be programmed for use of the RS485 interface:

- Device address,
- Baud rate,
- Operating mode.

Refer to the parameter list in the Appendix for the default factory setting and the setting ranges.

Addr.	Content
200	Device address (1 .. 255) valid for Modbus and Profibus
7	default factory setting

Profibus (optional)

Profibus profiles

The UMG104 can manage 16 profibus profiles. Each profibus profile contains 128 data bytes maximum.

The first data byte of the output area of the PLC (programmable logic controller) always contains the profile number of the profibus profile required by the UMG104.

To request a profibus profile, write the profile number in the first byte of the output area of the PLC.

All system variables can be individually scaled and converted into one of the following formats:

- 8, 16, 32 bit integer with and without sign.
- 32 or 64 bit float format.
- Big or little Endian¹⁾.

¹⁾ *Big-Endian = High byte before low byte*
Little-Endian = Low byte before high byte.

Addr.	Content
200	Device address (1 .. 255) valid for Modbus and Profibus 1 = default factory setting

Device master file GSD

The device master file for the UMG104 is called “JANI0D2B.GSD” and is included on the CD which belongs to the scope of supply.

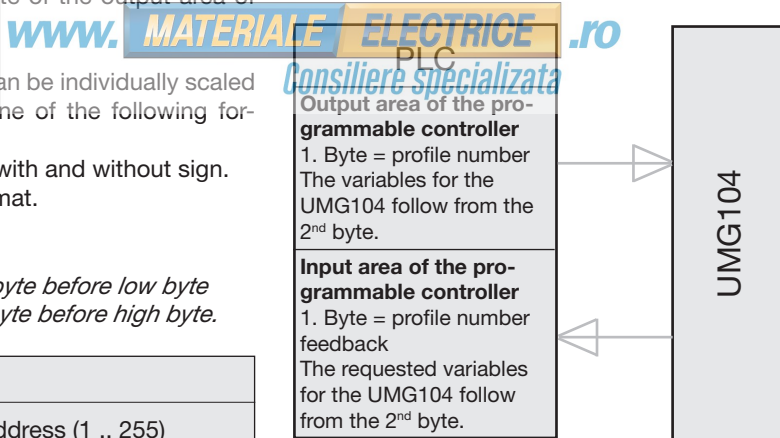

Fig. 54.1 Block diagram for data exchange between PLC and UMG104.

Default Profibus profile

Profibus profile number 0

	Byte Index	Value type	Value format	Scaling
1	1	Voltage L1-N	float	1
2	5	Voltage L2-N	float	1
3	9	Voltage L3-N	float	1
4	13	Voltage L4-N	float	1
5	17	Voltage L2-L1	float	1
6	21	Voltage L3-L2	float	1
7	25	Voltage L1-L3	float	1
8	29	Current L1	float	1
9	33	Current L2	float	1
10	37	Current L3	float	1
11	41	Current L4	float	1
12	45	Effective power L1	float	1
13	49	Effective power L2	float	1
14	53	Effective power L3	float	1
15	57	Effective power L4	float	1
16	61	Cosphi (math.) L1	float	1
17	65	Cosphi (math.) L2	float	1
18	69	Cosphi (math.) L3	float	1
19	73	Cosphi (math.) L4	float	1
20	77	Frequency	float	1
21	81	Effective power total L1-L4	float	1
22	85	Reactive power L1-L4	float	1
23	89	Apparent power total L1-L4	float	1
24	93	Cosphi (math.) total L1-L4	float	1
25	97	Effective current total L1-L4	float	1
26	101	Effective consumption total L1-L4	float	1
27	105	Ind. reactive consum. total L1-L4	float	1
28	109	THD voltage L1	float	1
29	113	THD voltage L2	float	1
30	117	THD voltage L3	float	1

Profibus profile number 1

	Byte-Index	Value type	Values format	Scaling
1	1	Voltage L1-N	Float	1
2	5	Voltage L2-N	Float	1
3	9	Voltage L3-N	Float	1
4	13	Voltage L2-L1	Float	1
5	17	Voltage L3-L2	Float	1
6	21	Voltage L1-L3	Float	1
7	25	Current L1	Float	1
8	29	Current L2	Float	1
9	33	Current L3	Float	1
10	37	Effective power L1	Float	1
11	41	Effective power L2	Float	1
12	45	Effective power L3	Float	1
13	49	Cosphi (math.) L1	Float	1
14	53	Cosphi (math.) L2	Float	1
15	57	Cosphi (math.) L3	Float	1
16	61	Frequency	Float	1
17	65	Effective power total L1-L3	Float	1
18	69	Reactive power total L1-L3	Float	1
19	73	Apparent power total L1-L3	Float	1
20	77	Cosphi (math.) total L1-L3	Float	1
21	81	Effective current total L1-L3	Float	1
22	85	Effective consumption total L1-L3	Float	1
23	89	Ind. Reactive consum. total L1-L3	Float	1
24	93	THD voltage L1	Float	1
25	97	THD voltage L2	Float	1
26	101	THD voltage L3	Float	1
27	105	THD current L1	Float	1
28	109	THD current L2	Float	1
29	113	THD current L3	Float	1

Profibus profile number 2

	Byte-Index	Value type	Values Format	Scaling
1	1	Effective consumption total L1-L3	Float	1
2	5	Drawn eff. consum. total L1-L3	Float	1
3	9	Supplied eff. consum. total L1-L3	Float	1
4	13	Reactive consumption total L1-L3	Float	1
5	17	Ind. reactive consum. total L1-L3	Float	1
6	21	Cap. reactive consum. total L1-L3	Float	1
7	25	Apparent consumption total L1-L3	Float	1
8	29	Effective consumption L1	Float	1
9	33	Effective consumption L2	Float	1
10	37	Effective consumption L3	Float	1
11	41	Inductive reactive consumption L1	Float	1
12	45	Inductive reactive consumption L2	Float	1
13	49	Inductive reactive consumption L3	Float	1

Profibus profile number 3

	Byte-Index	Value type	Values Format	Scaling
1	1	Effective power L1	Float	1
2	5	Effective power L2	Float	1
3	9	Effective power L3	Float	1
4	13	Effective power total L1-L3	Float	1
5	17	Current L1	Float	1
6	21	Current L2	Float	1
7	25	Current L3	Float	1
8	29	Current total L1-L3	Float	1
9	33	Effective consumption total L1-L3	Float	1
10	37	CosPhi (math.) L1	Float	1
11	41	CosPhi (math.) L2	Float	1
12	45	CosPhi (math.) L3	Float	1
13	49	CosPhi (math.) total L1-L3	Float	1
14	53	Reactive power L1	Float	1
15	53	Reactive power L2	Float	1
16	53	Reactive power L3	Float	1
17	53	Reactive power total L1-L3	Float	1
18	53	Apparent power L1	Float	1
19	53	Apparent power L2	Float	1
20	53	Apparent power L3	Float	1
21	53	Apparent power total L1-L3	Float	1

www.MATERIALE.ELECTRICE.IT
Consigliere specializata

Recordings

2 recordings are preconfigured in the default factory setting of the UMG104. Recordings are adjusted and extended via the software GridVis.

Recording 1

The following measured values are recorded with the time base of 15 minutes:

- Voltage effective L1
- Voltage effective L2
- Voltage effective L3
- Voltage effective L4
- Voltage effective L2-L1
- Voltage effective L3-L2
- Voltage effective L1-L3
- Current effective L1
- Current effective L2
- Current effective L3
- Current effective L4
- Active Power L1
- Active Power L2
- Active Power L3
- Active Power L4
- Active Power Sum L1-L3
- Active Power Sum L1-L4
- Reactive power fundamental L1
- Reactive power fundamental L2
- Reactive power fundamental L3
- Reactive power fundamental L4
- Reactive power fundamental Sum L1-L3

- Reactive power fundamental Sum L1-L4

(The mean value, minimum value and maximum value are also recorded for each measured value.)

Recording 2

The following measured values are recorded with the time base of 1 hour:

- Consumed Active Energy L1
- Consumed Active Energy L2
- Consumed Active Energy L3
- Consumed Active Energy L4
- Consumed Active Energy Sum L1-L3
- Consumed Active Energy Sum L1-L4
- Inductive Reactive Energy L1
- Inductive Reactive Energy L2
- Inductive Reactive Energy L3
- Inductive Reactive Energy L4
- Inductive Reactive Energy Sum L1-L3
- Inductive Reactive Energy Sum L1-L4

System information

Overrange

Overranges are displayed as long as they exist and cannot be acknowledged. An overrange exists if at least one of the four voltage or current measurement inputs lies outside their specified measuring range.

If an overrange exists it is shown in the display with “EEEE”.

The symbols L1, L2, L3 and L4 are used to indicate at which input the overrange has occurred. The “V” and “A” symbols indicate whether the overrange occurred in the current or in the voltage path.

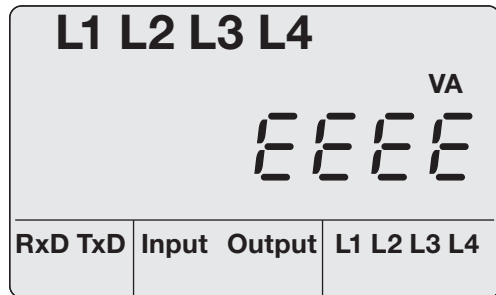

Fig. Measured value display with overrange.



Important!

Voltages and currents that lie outside the permissible measuring range can destroy the device.

Serial number

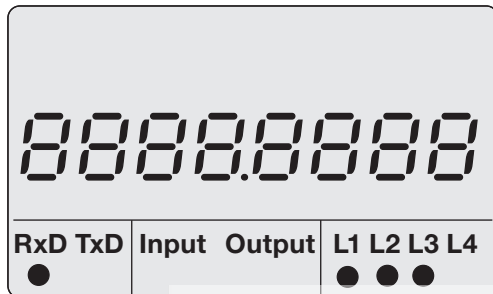

Fig. Measured value display with serial number.

Firmware release

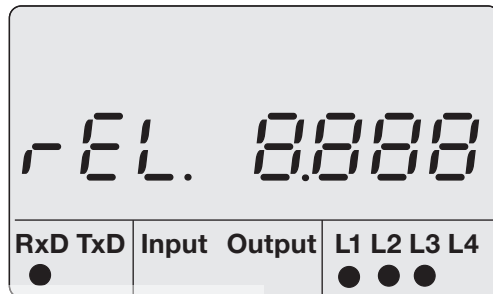

Fig. Measured value display for the firmware release.

www.MATERIALE-TECNICHE.it
Consigliere specializzata

Date

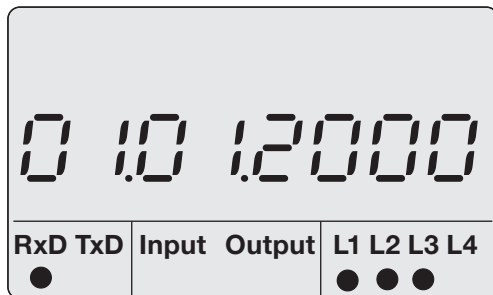

Fig. Measured value display with date.

Time

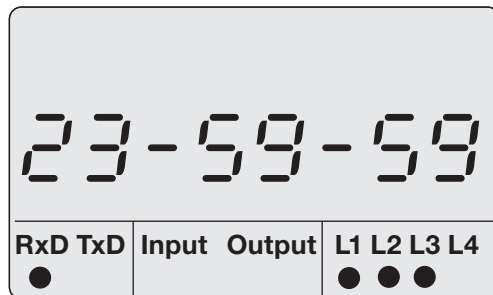

Fig. Measured value display with time.

Service and maintenance

The device is subjected to various safety checks before delivery and marked with a seal. If a device is opened, the safety checks must be repeated. A warranty will be provided for unopened devices only.

Repair and calibration

Repair work and calibration can be carried out by the manufacturer only.

Front film

The front film can be cleaned with a soft cloth and standard household cleaning agent. Do not use acids and products containing acid for cleaning.

Battery

The internal clock is provided with power from the power supply voltage. If the power supply voltage fails the clock is supplied by the battery. The clock supplies date and time information, e.g. for recordings and minimum and maximum values.

The life expectancy of the battery is at least 5 years, at a storage temperature of +45°C. The typical life expectancy of the battery is 8 to 10 years.

The device must be opened to change the battery. If the device has been opened a renewed safety check is necessary for safe

operation. A warranty will be provided for unopened devices only.

Disposal

The UMG104 can be reused or recycled as electronic scrap in accordance with the legal provisions. The permanently installed lithium battery must be disposed of separately.

Firmware update

If a firmware update has to be performed for your UMG104 you can do this with the GridVis software.

www.MATERIALS-ELECTRICE.ro

Should questions arise, which are not described in this manual, please contact the manufacturer directly.

We will need the following information from you to answer any questions:

- Device name (see rating plate),
- Serial name (see rating plate),
- Software release (see measured value display),
- Measuring-circuit voltage and power supply voltage,
- Precise description of the error.

Trouble shooting

Possible error	Cause	Remedy
No display .	External fusing for the power supply voltage has tripped. Device is defective.	Replace fuse. Send device to the manufacturer for repair.
No current display .	Measurement voltage is not connected. Measurement current is not connected.	Connect the measuring-circuit voltage. Connect measuring-circuit current.
Displayed current is too large or too small.	Current measurement in the wrong phase. Current transformer factor is incorrectly programmed.	Check connection and correct if necessary. Read out and program the current transformer transformation ratio at the current transformer.
“EEEE” and “A” in the display.	The current measuring range has been exceeded.	Check the measuring-circuit current and if necessary install a suitable current transformer.

www.MATERIALEELECTRICE.ro

Consiliere Specializata

Possible error	Cause	Remedy
Displayed voltage is too small or too large.	Measurement in the wrong phase. Voltage transformer incorrectly programmed.	Check connection and correct if necessary. Read out and program the voltage transformer transformation ratio at the voltage transformer.
Displayed voltage is too small.	Overrange. The peak voltage value at the measurement input has been exceeded by harmonic components.	Install voltage transformers. Important! Ensure the measurement inputs are not overloaded.
“EEEE” and “V” in the display.	The voltage measuring range has been exceeded.	Check the measuring-circuit voltage and if necessary install a suitable voltage transformer.
„Error CF„ in the display	The calibration data could not be read out.	Send device to the manufacturer for checking with a precise description of the error.
Active power consumption / supply is reversed.	At least one current transformer connection is mixed up/reversed. A current path is assigned to the wrong voltage path.	Check connection and correct if necessary. Check connection and correct if necessary.

www.MATERIALEELECTRICE.ro

Consiliere specializata

Possible error	Cause	Remedy
Active power too small or too large.	<p>The programmed current transformer transformation ratio is incorrect.</p> <p>The current path is assigned to the wrong voltage path.</p> <p>The programmed voltage transformer transformation ratio is incorrect.</p>	<p>Read out and program the current transformer transformation ratio at the current transformer.</p> <p>Check connection and correct if necessary.</p> <p>Read out and program the voltage transformer transformation ratio at the voltage transformer.</p>
No connection with the device.	<p>RS485:</p> <ul style="list-style-type: none"> - Device address is incorrect. - Wrong protocol. - Different bus speed. <p>- Termination missing.</p> <p>RS232</p> <ul style="list-style-type: none"> - Device address is incorrect. - Wrong protocol. - Different bus speed. - The concealed key (service) was used. 	<p>Adjust the device address.</p> <p>Correct protocol.</p> <p>Correct speed (baud rate). korrigieren.</p> <p>Close bus with terminating resistor (120 ohm).</p> <p>Adjust the device address.</p> <p>Correct protocol.</p> <p>Correct speed (baud rate).</p> <p>Overwriting the address 204 with 0</p>
Despite the measures above the device does not work.	Device is defective.	Send device to the manufacturer for checking with a precise description of the error.

Technical specifications

General information

Net weight	: 350g
Device dimensions	: approx l=107.5 mm, b=90 mm, h=82 mm (according to DIN 43871:1992)
Housing flammability class	: UL94V-0
Installed position	: any
Fixing/mounting	: 35 mm top hat rail (according to IEC/EN 60999-1, DIN EN 50022)
Battery	: Type VARTA CR2032, 3 V, Li-Mn
Backlight lifetime (optional)	: 40000h (50% of initial brightness)

Ambient conditions during operation

The UMG104 is intended for weather-protected, stationary use. The UMG104 fulfils the use conditions according to DIN IEC 60721-3-3.

Operating temperature range	: -10°C. +55°C
Relative humidity	: 5 to 95 %, (at +25 °C) without condensation
Degree of pollution	: 2
Operating altitude	: 0 .. 2000 m above sea level
Installed position	: any
Ventilation	: Forced ventilation is not required.

Transport and storage

The following information applies to devices which are transported or stored in the original packaging.

Free fall	: 1m
Temperature	: -20°C to +70°C

www.MATERIALE ELETTRICE .ro
Consultere specializata

Power supply voltage

The power supply voltage must be connected to the UMG104 via a UL listed fuse.

Line circuit breaker	: 6A, Typ C (approved to UL / IEC)
Cylindrical fuses	: 0.6A, tripping characteristics M (medium time lag)
Cylindrical fuses	: 0.75A, tripping characteristics F (fast acting)

Option 230V

Nominal range	: 95V .. 240V (50/60 Hz) or DC 135V .. 340V
Operating range	: +-10% of nominal range
Installation overvoltage category	: 300V CATIII
Power consumption	: max 3.2W, max 9VA

Option 90V

Nominal range	: 50V .. 110V (50/60 Hz) or DC 50V .. 155V
Operating range	: +-10% of nominal range
Installation overvoltage category	: 300V CATIII
Power consumption	: max 3.2W, max 9VA

Option 24V

Nominal range	: 20V .. 50V (50/60 Hz) or DC 20V .. 70V
Operating range	: +-10% of nominal range
Installation overvoltage category	: 300V CATII
Power consumption	: max 5W, max 8VA

Connectable conductors

Only one conductor may be connected per terminal connection!

Solid core, multi-core, flexible core	: 0.08 - 2,5 mm ² , AWG 28 - 12
Pin-end connector, wire end ferrules	: 1.5 mm ² , AWG 16

www.MATERIALE-ELETRICHE.ro
Consiliere specializata

Protection class

Class II according to IEC 60536 (VDE 0106, Part 1), i.e. a PE terminal is not required!

Protection against ingress of solid foreign
bodies and water

: IP20 according to EN 60529 September 2000,
IEC 60529:1989

www.MATERIALEELECTRICE.ro
Consiliere specializata

Inputs and outputs

2 digital inputs

Pulse input (S0)

Maximum counting frequency : 20 Hz

Switching input

Response time (Jasic program) : 200 ms

Input signal applied : 18V, 28 V DC (typically 4 mA)

Input signal not applied : 0 .. 5 V DC, current less than 0.5 mA

2 digital outputs, semi-conductor relay, not short-circuit proof.

Switching voltage : max 60 V DC, 30 V AC

Switching current : max 50 mAeff AC/DC

Response time (Jasic program) : 200 ms

Output of voltage dips : 20 ms

Output of voltage overranges : 20 ms

Pulse output (operating pulses) : max 20 Hz

Cable length : up to 30 m unshielded
: greater than 30m shielded

Connectable conductors

Solid core, multi-core, flexible core : 0.08 - 1.5 mm²

Pin-end connector, wire end ferrules : 1 mm², only one conductor may connected per terminal connection!

www.MATERIALE-ELECTRICE.ro
Consigliere specializata

Temperature measurement input

Update time	: approx 200 ms
Connectable sensors	: PT100, PT1000, KTY83, KTY84
Total burden (sensor + cable)	: max 4 kohm

Sensor type	Temperature range	Resistance range	Measurement uncertainty
KTY83	-55 ° .. +175 °C	500 ohm .. 2.6 kohm	± 1.5% rng
KTY84	-40 ° .. +300 °C	350 ohm .. 2.6 kohm	± 1.5% rng
PT100	-99 ° .. +500 °C	60 ohm .. 180 ohm	± 1.5% rng
PT1000	-99 ° .. +500 °C	600 ohm .. 1,8 kohm	± 1.5% rng

rng = measuring range

Consigliere specializzata

Cable length	: up to 30 m unshielded : greater than 30 m shielded
Connectable conductors	
Solid core, multi-core, flexible core	: 0.08 - 1.5 mm ²
Pin-end connector, wire end ferrules	: 1 mm ² , only one conductor may be connected per terminal connection!

Interfaces

RS232		: 5 pin screw-type terminals.
Protocol		: Modbus RTU/slave
Transfer rate		9600 bps, 19.2 kbps, 38.4 kbps, 115.2 kbps
RS485		: 2 pin screw-type terminals.
Protocol, modbus RTU		: Modbus RTU/slave.
Transfer rate		: 9.6 kbps, 19.2 kbps, 38.4 kbps, 57.6 kbps, 115.2 kbps, 921.6 kbps
RS485 (optional)		: Connector, SUB D 9 pin
Protocol, profibus (optional)		: Profibus DP/V0 according to EN 50170
Transfer rate		: 9.6 kbaud up to 12 Mbaud

www.MATERIALEELECTRICE.ro
Consiliere specializata

Measurement uncertainty

The measurement uncertainty of the UMG104 applies to use of the following measuring ranges. The measured value must lie within the given limits. Outside these limits the measurement uncertainty is unspecified.

Measured value	Measurement uncertainties
Voltage	$\pm 0.2\%$ DIN EN 61557-12:2008
Current L	$\pm 0.25\%$ based on DIN EN 61557-12:2008
Current N	$\pm 1\%$ DIN EN 61557-12:2008
Power	$\pm 0.4\%$ DIN EN 61557-12:2008
Harmonic components U, I	Class 1 DIN EN 61000-4-7
Active energy	
Current transformer/5A	Class 0.5S (DIN EN 62053-22:2003, IEC 62053:22:2003)
Current transformer/1A	Class 1 (DIN EN 62053-21:2003, IEC 62053:21:2003)
Reactive energy	
Current transformer/5A	Class 2 (DIN EN 62053-23:2003, IEC 62053:23:2003)
Current transformer/1A	Class 2 (DIN EN 62053-23:2003, IEC 62053:23:2003)
Frequency	$\pm 0.01\text{Hz}$
Internal clock	± 1 minute/month (18°C ... 28 °C)

The specifications apply under the following conditions:

- Annual recalibration,
- a warming up time of 10 minutes,
- an ambient temperature of 18 .. 28°C.

If the device is operated outside the range from 18 .. 28°C an additional measurement error equal to $\pm 0.01\%$ of the measured value must be taken into account per °C difference.

NOTE

Note on saving measured values and configuration data:

Since the following measured values are saved in a non-volatile memory every 5 minutes, the recording may **be interrupted for a** maximum of 5 minutes in case the operating voltage fails:

- Comparator timer
- S0 counter statuses
- Min. / Max. / mean values
(without the date and time)
- Energy values

Configuration data is saved immediately.

A detailed Modbus address and parameter list can be found at www.janitza.de

www.MATERIALEELETTRICE.ro
Consiliere specializata

Measuring inputs

Voltage measurement

Three-phase 4-wire systems (L-N/L-L)	: max. 277 V/480 V
Three-phase 3-wire systems (L-L)	: max. 480 V
Resolution	: 0,01 V
Measurement range L-N	: 0 ¹⁾ .. 600Vrms
Measurement range L-L	: 0 ¹⁾ .. 1000Vrms
Crest-factor	: 2 (referring to 480 Vrms)
Measurement category	: 300V CAT III
Specified impulse withstand voltage	: 4 kV
Impedance	: 4 MOhm/phase
Power input	: approx 0,1 VA
Scanning frequency	: 20 kHz/phase
Fundamental oscillation	: 45 Hz, 65 Hz

¹⁾The UMG104 can only detect measurement values if a voltage L-N larger than 10Veff or a voltage L-L larger than 18Veff is applied to at least one voltage measurement input.

Connectable conductors (current measurement and voltage measurement)

Only one conductor may connected per terminal connection.

Solid core, multi-core, flexible core : 0.08 - 4 mm², AWG 28 - 12

Pin-end connector, wire end ferrules : 2.5 mm², AWG 14

Current measurement

Nominal current	: 5A
Rated current	: 6A
Resolution in the display	: 10mA
Measurement range	: 0.001 .. 8.5Arms
Crest-faktor	: 2 (referring to 6 Arms)
Measurement category	: 300 V CAT III
Specified impulse withstand voltage	: 4 kV
Power input	: approx 0.2 VA (Ri=5 mohm)
Overload for 1 sec	: 100 A (sinusoidal)
Scanning frequency	: 20 kHz

www.MATERIALE-ELECTRICE.ro

Consiliere specializata

Parameter list

Add	Name	Setting range	Units	Default setting
000	Current transformer, primary, L1..L4	0 .. 1000000	A	5
001	Current transformer, secondary, L1..L4	1 .. 5	A	5
002	Voltage transformer, primary, L1..L4	0 .. 1000000	V	400
003	Voltage transformer, secondary, L1..L4	1 .. 999	V	400
010	Current transformer, primary, L1	0 .. 1000000	A	5
011	Current transformer, secondary, L1	1 .. 5	A	5
012	Voltage transformer, primary, L1	0 .. 1000000	V	400
013	Voltage transformer, secondary, L1	1 .. 999	V	400
020	Current transformer, primary, L2	0 .. 1000000	A	5
021	Current transformer, secondary, L2	1 .. 5	A	5
022	Voltage transformer, primary, L2	0 .. 1000000	V	400
023	Voltage transformer, secondary, L2	1 .. 999	V	400
030	Current transformer, primary, L3	0 .. 1000000	A	5
031	Current transformer, secondary, L3	1 .. 5	A	5
032	Voltage transformer, primary, L3	0 .. 1000000	V	400
033	Voltage transformer, secondary, L3	1 .. 999	V	400
040	Current transformer, primary, L4	0 .. 1000000	A	5
041	Current transformer, secondary, L4	1 .. 5	A	5
042	Voltage transformer, primary, L4	0 .. 1000000	V	400
043	Voltage transformer, secondary, L4	1 .. 999	V	400

Add	Name	Setting range	Units	Default setting
100	Automatically get TFTP configuration file 0 = switched off x = file number	0 .. 9999	-	0
101	TFTP error handling 0 = In the event of an error the Configuration menu appears in the UMG104. 1 = In the event of an error the does NOT switch to the Configuration menu of the UMG104.	0 .. 1	-	0
110	Current transformer circuit (L1 .. L3) 0 = three current transformers 1 = two current transformers (Aron circuit)	0 .. 1	-	0
111	Voltage measurement system configuration 0 = three-phase 4-conductor system (TT, TN system) 1 = three-phase 3-conductor system (IT system)	0 .. 1	-	0
112	Deletes all real and apparent energy meters and S0-counters (1 = delete)	0 .. 1	-	0
113	Deletes all reactive energy meters (1 = delete)	0 .. 1	-	0
114	Resets all minimum and maximum values (1 = reset)	0 .. 1	-	0

Add	Name	Setting range	Units	Default setting
200	Device address, modbus/profibus	1 .. 255		1
201	Baud rate, RS232 0 = 9600 bit/s 1 = 19200 bit/s 2 = 38400 bit/s 3 = 57600 bit/s 4 = 115200 bit/s	0 .. 4		4
202	Baud rate, RS485 0 = 9600 bit/s 1 = 19200 bit/s 2 = 38400 bit/s 3 = 57600 bit/s 4 = 115200 bit/s 5 = 921600 bit/s	0 .. 5		4
203	RS485, mode 0 = modbus RTU/slave	0 .. 6		0
204	RS232, mode 0 = modbus RTU/slave 3 = Debug 6 = SLIP	0 .. 6		0

www. **MATERIALE** **ELECTRICE** .ro
Consigliere specializzata

Add	Name	Setting range	Units	Default setting
400	Day	1 .. 31		xx
401	Month	1 .. 12		xx
402	Year	1 .. 9999		xxxx
403	Hour	0 .. 23		xx
404	Minute	0 .. 59		xx
405	Second	0 .. 59		xx
406	Accept date and time 1 = accept set data	0, 1		0
500	Device password	0 .. 9999		xxxx
600	LCD, Contrast	0 .. 99	-	50
601	LCD, Backlight, max. brightness	0 .. 16	-	10
602	LCD, Backlight, min. brightness	0 .. 8	-	3
603	LCD, Backlight, Time to switch from maximum to minimum brightness.	0 .. 9999	s	60

Measured value displays

You can have the following measured values shown on the display, with the default factory setting, using keys 1 and 2. The measured value names used are abbreviated and have the following meaning:

- Active power demand = active power demand, imported supply
- Reactive power = reactive power, inductive
- Active power demand = active power demand, imported supply with return block

Voltage L1-N	Voltage L2-N	Voltage L3-N	Voltage L4-N		
Voltage L1-L2	Voltage L2-L3	Voltage L3-L1			
Current L1	Current L2	Current L3	Current L4		
Active Power demand L1	Active Power demand L2	Active Power demand L3	Active Power demand L4	Active Power demand L1..L3	Active Power demand L1..L4
Reactive Power L1	Reactive Power L2	Reactive Power L3	Reactive Power L4	Reactive Power L1..L3	Reactive Power L1..L4
Active Energy demand L1	Active Energy demand L2	Active Energy demand L3	Active Energy demand L4	Active Energy demand L1..L3	Active Energy demand L1..L4
cos(phi) L1	cos(phi) L2	cos(phi) L3	cos(phi) L4	cos(phi) L1..L3	
Frequency Rotating field	Temperature input	Date	Time	Serial number	Firmware Release

www.MATERIALELECTRICE.ro
 Consiliere specializata

Declaration of conformity

The product fulfils the following EC Directives:	
2004/108/EG	Electromagnetic compatibility of electrical equipment.
2006/95/EG	Electrical equipment for use within certain voltage limits.
Considered standards:	
Noise immunity	
IEC/EN 61326-1:2013	Class A: Industrial environment
IEC/EN 61000-4-2:2009	Electrostatic discharge
IEC/EN 61000-4-3:2011	Electromagnetic RF Field 80-2700MHz
IEC/EN 61000-4-4:2013	Burst
IEC/EN 61000-4-5:2007	Surge
IEC/EN 61000-4-6:2009	Conducted disturbances 0.15-80MHz
IEC/EN 61000-4-8:2010	Power frequency magnetic field
IEC/EN 61000-4-11:2005	Voltage dips, short interrupts and voltage variations
Noise emission	
IEC/EN 61326-1:2013	Class B: Residential environment
IEC/CISPR11/EN 55011:2011	Radio disturbance field strength 30-1000MHz
IEC/CISPR11/EN 55011:2011	Radio disturbance voltage 0.15-30MHz
Equipment safety	
IEC/EN 61010-1:2011	Safety requirements for electrical equipment for Measurement, control and laboratory use – Part 1: General requirements
IEC/EN 61010-2-030:2011	Particular requirements for testing and measuring circuits

Dimensioned drawings

Front view

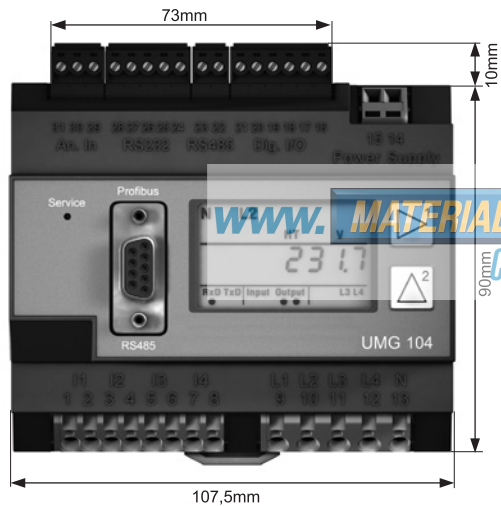

Side view

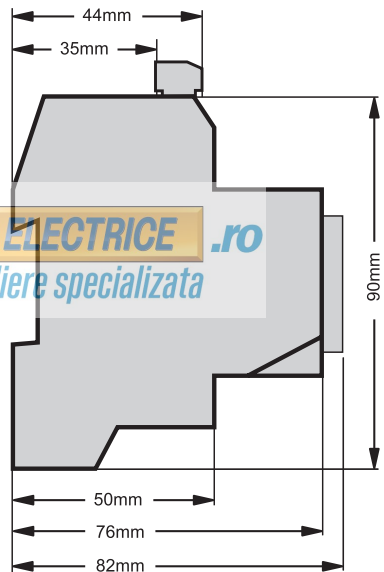

WWW.MATERIALEELECTRICE.ro
Consiliere specializata

UMG104 connection example

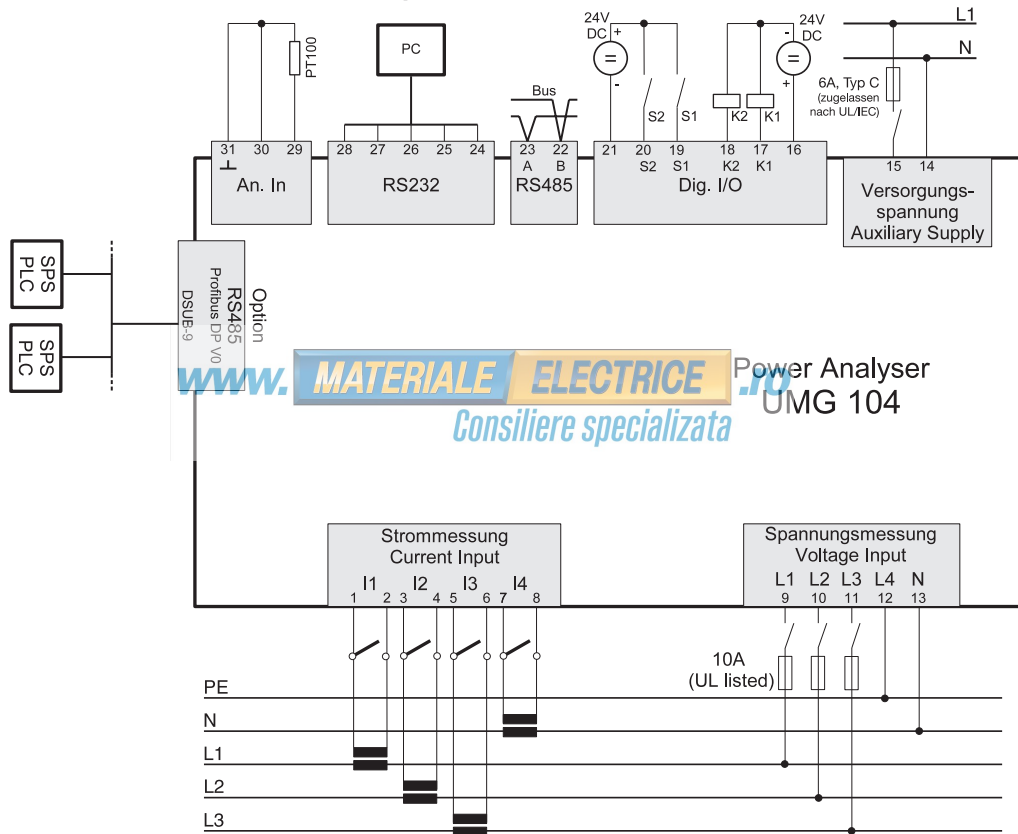

www.MATERIALELECTRICE.it Power Analyser UMG 104
 Consigliere specializata

Quick Reference Instructions

Adjusting the primary current

You have three current transformers of the same type with a current transformer ratio of 200 A/5 A. You would like to program the primary current with 200 A.

To do this you must enter the value 200 for the primary current in the address 000.

The secondary current is preset to 5 A in address 001 in the factory.

Switch to Program mode

Simultaneously press keys 1 and 2 for around one second.

The PRG symbol for programming mode appears.

The content of address 000 is displayed.



Change address

As address 000 is already displayed the address does not have to be changed.

Enter the primary current.

Use Key 1 to select the digit to be changed.

Use Key 2 to change the selected digit.

Exit program mode

Simultaneously press both keys for around 1 second.

The current transformer setting is saved and the device returns to display mode.

