



Residual current circuit breakers with integral overcurrent protection DIFO

EVE



Build-in switch, Build-in devices



Control equipment



RF Control Wireless System

ETICON



Modular contactors for installation into distribution boards



Miniature and auxiliary contactors CE, CEC

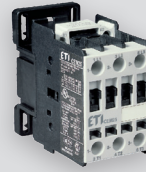

Motor contactors CEM



Motor protective circuit breakers MPE&MS

ETIBREAK



Low breaking capacity MCCBs, Low voltage MCCBs and low voltage switch disconnectors



Low voltage moulded case circuit breakers with residual current protection



Accessories

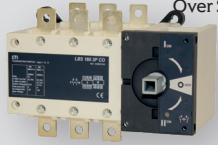

Load Break Change Over Switch LBS..CO



Motorised Change Over Load Break Switch MLBS..CO



Fuse Load Break Switch FLBS



Rotary Cam Switches



Surge arresters group T WENT



Surge arresters group B



Surge arresters group C



Surge arrester ETITEC group D

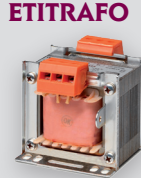

ETITRAFO

Single phase safety and insulating transformers



Low voltage cylindrical fuse-links CH



Fuse disconnectors for cylindrical fuse-links EFD



Fuse disconnectors for cylindrical fuse-links PCF

NV/NH



Low voltage NH knife-blade fuse-links (gL/gG)

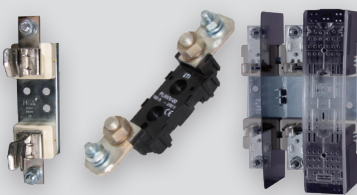

Fuse bases



Low voltage fuse-rails



Strip type fuse-switch-disconnectors



Disconnectors with fuses



Double insulation enclosures IP66, IK10



Metal enclosures



Free-standing cable distribution cabinets

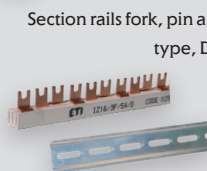

Section rails fork, pin and SKN type, DIN rails



DIN rail distribution blocks EDB, Accessories

[Building, Industry and Energy Catalogue](#)

ULTRA QUICK

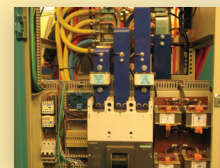

Fuses for semiconductor devices protection

[Ultra Quick Catalogue](#)

GREEN PROTECT



Protection of Photovoltaic Systems and other renewable energy sources

[Green Protect Catalogue](#)



ETI POLAM Sp. z o.o.
Ul. Jana Pawla II 18, 06100 Pultusk, Poland
Phone: +48 23 691 93 00
E-mail: etipolam@etipolam.com.pl
www.etipolam.com.pl

ETI SARAJEVO d.o.o.
Hifzi Bjelevca 13, 71 000 Sarajevo, BiH
Phone: +387 33 77 52 50
E-mail: etisa@bih.net.ba
www.eti.ba

ETI UKRAINE, LTD
Ul. Akademika Tupoleva 19,
04128 Kiev, Ukraine
Phone: +380 44 494 21 80
E-mail: office@eti.ua
www.eti.ua

ETIBALTUS, UAB
Tilzes 41a, 47187 Kaunas, Lithuania
Phone: +370 37 261 582
E-mail: info@etibaltus.lt
www.etibaltus.lt

ETI B
Zvečanska 56/17, 11000 Beograd, Serbia
Phone: +381 11 3691 092
E-mail: miodrag.stojkovic@etib.rs
www.etib.rs

ETI HU Elektrotechnikai, Kft.
Rokolya utca 25, 1131 Budapest, Hungary
Phone: +36 1 238 0784
E-mail: eti@eti-hu.hu
www.eti-hu.hu

ETI ROMANIA S.R.L.
Str. Doina, Nr. 17,
Sector 5,
Bucharest, Romania
Phone: +40 (0)21 317 1743
E-mail: vasilije.ljuba@eti.si
www.etigroup.ro

ETI Elektroelement d.o.o.
For technical engineering and store
of electrotechnical products
Ulica grada Vukovara 235/V,
10000 Zagreb, Croatia
www.eti.si/hr

ETI Russia
St. Ugreshskaya d. 2, Moscow, Russia
Phone: +7(4)95 415 42 29
E-mail: info@etirus.ru
www.etimoskva.ru

ETI Prostik d.o.o.
Production, sales, designing and consulting
Obrezija 5, 1411 Izlake, Slovenia
Phone: +386 3 5657 570
E-mail: etiprostik@eti.si
www.etigroup.eu

ETI Elektroelement s.r.o.
P3 Logistics Parks, Budova F
Paceřická 2773/1
19300 Praha - Horní Počernice
Tel:00420 777 950 203
E-mail:jan.tichy@etielektroelement.cz

PARENT COMPANY

ETI d.o.o.
Obrezija 5, 1411 Izlake, Slovenia
Phone: +386 3 5657 570
E-mail: eti@eti.si
www.etigroup.eu
www.eti.si

ASSOCIATED COMPANIES

ITALWEBER S.p.A.
Via Enrico Fermi 40/42, 20090 Assago, Italy
Phone: +39 02 939 771
E-mail: info@italweber.it
www.italweber.it

SUBSIDIARIES

ETI Proplast d.o.o.
Obrezija 5, 1411 Izlake, Slovenia
Phone: +386 3 56 57 590
E-mail: etiproplast@eti.si
www.etiproplast.si

ETI DE GmbH
Dorfwiesenweg 13, 63828 Kleinkahl, Germany
Phone: +49 6024 6397-0
E-mail: contact@eti-de.de
www.eti-de.de

SOLID GSX

GT HERMETIC ENCLOSURES (IP66)	5
METAL ENCLOSURES WALL - MOUNTED TYPE 4XN160 (IP 41, 42, 44) AND FLUSH - MOUNTED TYPE 4XP160 (IP 42, 44)	21 95
INTERNAL STRUCTURAL SYSTEM AND ACCESSORIES	
ACCESSORIES AND INTERNAL CONSTRUCTION SYSTEM	104
HXS STANDING ENCLOSURES (IP55, 65)	111
ACCESSORIES AND INTERNAL CONSTRUCTION SYSTEM	
EXAMPLES OF ENCLOSURES CONFIGURATIONS	

METAL ENCLOSURES SYSTEM - SAFETY CLASS I



GT hermetic enclosures (IP65)



→ Enclosures made of high quality steel sheet



→ Painted with polyester powder paint RAL 7035 - only for internal use



→ Door opening angle - 120 degrees



→ Specially contoured edges of the body provide solid protection against water

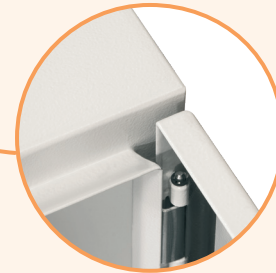

→ The door opens in the outer contour of the enclosure, which allows direct connection of several enclosures in series (special hinge construction)



→ The door can be installed on the left and right side



→ Cable gland with curved edges for stiffening and poured gasket ensuring perfect tightness of the enclosure



→ Very high quality of polyurethane gasket thanks to the latest technology of pouring gaskets



GT metal hermetic enclosures (IP66)

Application:

Metal hermetic enclosures (made of sheet steel) with a GT type mounting plate cover a wide range of applications for both industrial and residential construction. Thanks to their design, they provide excellent tightness, mechanical strength and functionality. They are used where electrical devices are exposed to adverse effects such as water, dust and mechanical influences.

Features:

- The door opening in the external enclosure contour, which allows direct connection in series of several enclosures (special design of hinges)
- High quality of polyurethane gasket - by using the newest technology in pouring of seal
- Enclosures made of high quality sheet steel
- Mechanically resistant (ex. against of hits) - IK10
- The doors in enclosures of height of 400mm and more, and width of 800mm, are equipped with vertical and horizontal reinforcements with mounting holes spaced 25mm
- Polyester powder - painted for external applications, although the enclosure are intended for internal applications.
- UV resistant

Technical data	
Degree of protection	IP66
Mechanical strength	IK10
Colour	Light grey/RAL 7035
Paint	Polyester powder
Application	Indoor enclosures
operating temperature	-5° C ... +40° C
Standards	IEC/EN 62208 IEC/EN 60529 IEC 62262
Directives	RoHS

Enclosures are supplied with:

- cable gland cover with fixing elements
- mounting plate with fixing elements
- key (KEY-D5-M)
- door with a lock with a double bit insert (LK-D3 M22)
- mounting hole plugs
- earthing set (without cable)



Features and technical characteristics:



Enclosures made of high quality sheet steel thickness from 1.2 mm to 2 mm.
Resistant to external mechanical impacts - IK10.

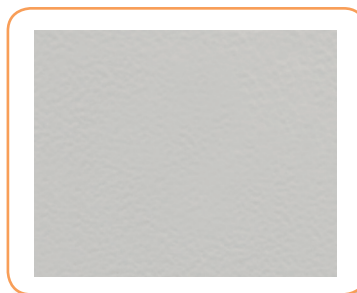

Polyester powder paint RAL 7035 for external applications. *



Specially profiled edges of the housing ensure stiffness and exact protection against water.



Poured polyurethane gasket on the door providing IP65 protection.



Cable flanges with curved edges to stiffen and poured gasket provides excellent cover.



Door opening angle up to 120 degrees.



The door opening in the external enclosure contour, which allows direct connection in series of several enclosures (special design of hinges)



The door assembled on the left or right side.



Door closing depending on the dimensions of enclosures: 1 lock for heights up to 400 mm.



Door closing depending on the dimensions of enclosures: 2 locks for heights of 500 mm and more.



Door closing depending on the dimensions of enclosures: 3-points closure for heights of 1000 mm and more.



The doors in enclosures for heights of 400 mm and more, are equipped with vertical reinforcements with mounting holes spaced 25 mm.



The doors in enclosures for heights of 400 mm and more are equipped with horizontal reinforcements with mounting holes spaced 25 mm.



Solid construction of 3-point fasteners.



Enclosures for heights of 800 mm and more are equipped with three hinges.



The body and door M6x12 mm earth terminals.



Mounting to the wall directly or with a special wall holder -set (separate ordered). The diameter of holes on the back plate of the body is $\varnothing 10$ mm.



Mounting plate is made of galvanized steel sheet with a thickness of 2 mm. Mounting plate is fixed to the body with screws M8x25 mm. Depending on the size, special foldings of the plate edge are made for better stiffness.

Symbols:

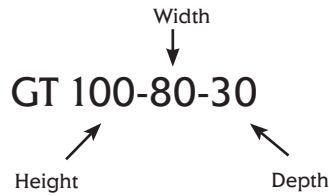

Enclosures GT with mounting plate

Type	Code	Height (mm)	Width X (mm)	Depth Z (mm)	Max. quantity of moduls (18mm) using a mounting holder		Lock quantity	Hinges quantity	Weight (kg)
GT 25-20-15	001123100	250	200	150	-	-	1	2	3,61
GT 30-20-15	001102101	300	200	150	-	-	1	2	4,14
GT 30-30-15	001102102	300	300	150	-	-	1	2	5,65
GT 30-30-20	001102103	300	300	200	-	-	1	2	6,38
GT 30-30-25	001102104	300	300	250	-	-	1	2	7,13
GT 40-30-15	001102105	400	300	150	2x12	24	1	2	7,07
GT 40-30-20	001102106	400	300	200	2x12	24	1	2	7,90
GT 40-30-25	001102107	400	300	250	2x12	24	1	2	8,74
GT 40-40-15	001102108	400	400	150	2x17	34	1	2	8,92
GT 40-40-20	001102109	400	400	200	2x17	34	1	2	9,90
GT 40-40-25	001102110	400	400	250	2x17	34	1	2	10,89
GT 40-60-20	001102111	400	600	200	2x26	52	1	2	14,57
GT 40-60-25	001102112	400	600	250	2x26	52	1	2	15,87
GT 40-60-30	001102113	400	600	300	2x26	52	1	2	17,17
GT 50-40-15	001102114	500	400	150	3x17	51	2	2	10,69
GT 50-40-20	001102115	500	400	200	3x17	51	2	2	11,17
GT 50-40-25	001102116	500	400	250	3x17	51	2	2	12,86
GT 50-55-20	001102117	500	550	200	3x24	72	2	2	15,30
GT 50-55-25	001102118	500	550	250	3x24	72	2	2	16,62
GT 60-40-15	001102119	600	400	150	3x17	51	2	2	12,47
GT 60-40-20	001102120	600	400	200	3x17	51	2	2	13,64
GT 60-40-25	001102121	600	400	250	3x17	51	2	2	14,82
GT 60-60-20	001102122	600	600	200	3x26	78	2	2	20,02
GT 60-60-25	001102123	600	600	250	3x26	78	2	2	21,51
GT 60-60-30	001102124	600	600	300	3x26	78	2	2	22,99
GT 60-80-30	001102125	600	800	300	3x36	108	2	2	32,65
GT 65-55-20	001102126	650	550	200	4x24	96	2	2	19,86
GT 65-55-25	001102127	650	550	250	4x24	96	2	2	21,32
GT 80-40-20	001102128	800	400	200	5x17	85	2	3	19,45
GT 80-40-25	001102129	800	400	250	5x17	85	2	3	21,11
GT 80-55-20	001102130	800	550	200	5x24	120	2	3	26,17
GT 80-55-25	001102131	800	550	250	5x24	120	2	3	28,11
GT 80-60-20	001102132	800	600	200	5x26	130	2	3	28,13
GT 80-60-25	001102133	800	600	250	5x26	130	2	3	30,14
GT 80-60-30	001102134	800	600	300	5x26	130	2	3	32,17
GT 80-60-40	001102135	800	600	400	5x26	130	2	3	36,20
GT 80-80-20	001102136	800	800	200	5x36	180	2	3	35,93
GT 80-80-25	001102137	800	800	250	5x36	180	2	3	38,31
GT 80-80-30	001102138	800	800	300	5x36	180	2	3	40,68
GT 80-80-40	001102139	800	800	400	5x36	180	2	3	45,44
GT 80-100-30	001102140	800	1000	300	5x46	230	2	3	49,20
GT 80-100-40	001102141	800	1000	400	5x46	230	2	3	54,67
GT 100-60-25	001102142	1000	600	250	6x26	156	3 p	3	36,35
GT 100-60-30	001102143	1000	600	300	6x26	156	3 p	3	38,60
GT 100-60-40	001102144	1000	600	400	6x26	156	3 p	3	43,10
GT 100-80-25	001102145	1000	800	250	6x36	216	3 p	3	46,11
GT 100-80-30	001102146	1000	800	300	6x36	216	3 p	3	48,72
GT 100-80-40	001102147	1000	800	400	6x36	216	3 p	3	53,94
GT 100-100-25	001102148	1000	1000	250	6x46	276	3 p	3	55,87
GT 100-100-30	001102149	1000	1000	300	6x46	276	3 p	3	58,83
GT 100-100-40	001102150	1000	1000	400	6x46	276	3 p	3	64,78
GT 120-60-25	001102151	1200	600	250	7x26	182	3 p	3	42,55
GT 120-80-25	001102152	1200	800	250	7x36	252	3 p	3	53,90
GT 120-80-30	001102153	1200	800	300	7x36	252	3 p	3	56,76
GT 120-80-40	001102154	1200	800	400	7x36	252	3 p	3	62,45
GT 120-100-30	001102155	1200	1000	300	7x46	322	3 p	3	68,47
GT 120-100-40	001102156	1200	1000	400	7x46	322	3 p	3	74,88

Note: The other parameters are on the next page.

Enclosures GT with mounting plate									
Type	Cable entry depth B1 (mm)	Cable entry width A1 (mm)	Cover cable entry depth B (mm)	Cover cable entry width A (mm)	Enclosure load (kg)	Mounting plate load (kg)	The doors load * (kg)	Max. allowed power losses when max. number of devices are installed (W)	Packaging (pcs.)
GT 25-20-15	70	140	110	180	150	125	25	11	1
GT 30-20-15	70	140	110	180	150	125	25	14	1
GT 30-30-15	70	240	110	280	150	125	25	17	1
GT 30-30-20	120	240	160	280	150	125	25	21	1
GT 30-30-25	170	240	210	280	175	150	25	20	1
GT 40-30-15	70	240	110	280	175	150	25	22	1
GT 40-30-20	120	240	160	280	175	150	25	25	1
GT 40-30-25	170	240	210	280	175	150	25	28	1
GT 40-40-15	70	340	110	380	175	150	25	25	1
GT 40-40-20	120	340	160	380	225	200	25	30	1
GT 40-40-25	170	340	210	380	225	200	25	25	1
GT 40-60-20	120	540	160	580	225	200	25	40	1
GT 40-60-25	170	540	210	580	225	200	25	46	1
GT 40-60-30	170	540	210	580	225	200	25	36	1
GT 50-40-15	70	340	110	380	225	200	25	30	1
GT 50-40-20	120	340	160	380	225	200	25	40	1
GT 50-40-25	170	340	210	380	225	200	25	41	1
GT 50-55-20	120	490	160	530	225	200	25	42	1
GT 50-55-25	170	490	210	530	225	200	25	45	1
GT 60-40-15	70	340	110	380	225	200	25	38	1
GT 60-40-20	120	340	160	380	225	200	25	40	1
GT 60-40-25	170	340	210	380	225	200	25	46	1
GT 60-60-20	120	540	160	580	275	250	25	55	1
GT 60-60-25	170	540	210	580	275	250	25	60	1
GT 60-60-30	170	540	210	580	275	250	25	66	1
GT 60-80-30	170	740	210	780	275	250	25	82	1
GT 65-55-20	120	490	160	530	275	250	25	51	1
GT 65-55-25	170	490	210	530	275	250	25	55	1
GT 80-40-20	120	340	160	380	275	250	25	53	1
GT 80-40-25	170	340	210	380	275	250	25	58	1
GT 80-55-20	120	490	160	530	275	250	25	62	1
GT 80-55-25	170	490	210	530	275	250	25	65	1
GT 80-60-20	120	540	160	580	325	300	25	70	1
GT 80-60-25	170	540	210	580	325	300	25	78	1
GT 80-60-30	170	540	210	580	325	300	25	101	1
GT 80-60-40	170	540	210	580	325	300	25	87	1
GT 80-80-20	120	740	160	780	325	300	25	70	1
GT 80-80-25	170	740	210	780	325	300	25	80	1
GT 80-80-30	170	740	210	780	325	300	25	104	1
GT 80-80-40	170	740	210	780	390	350	25	117	1
GT 80-100-30	170	940	210	980	390	350	25	123	1
GT 80-100-40	170	940	210	980	390	350	25	125	1
GT 100-60-25	170	540	210	580	390	350	40	92	1
GT 100-60-30	170	540	210	580	390	350	40	100	1
GT 100-60-40	170	540	210	580	390	350	40	115	1
GT 100-80-25	170	740	210	780	390	350	40	113	1
GT 100-80-30	170	740	210	780	390	350	40	123	1
GT 100-80-40	170	740	210	780	390	350	40	128	1
GT 100-100-25	170	940	210	980	390	350	40	118	1
GT 100-100-30	170	940	210	980	390	350	40	122	1
GT 100-100-40	170	940	210	980	390	350	40	130	1
GT 120-60-25	170	540	210	580	390	350	40	110	1
GT 120-80-25	170	740	210	780	390	350	40	116	1
GT 120-80-30	170	740	210	780	390	350	40	150	1
GT 120-80-40	170	740	210	780	390	350	40	160	1
GT 120-100-30	170	940	210	980	390	350	40	166	1
GT 120-100-40	170	940	210	980	390	350	40	170	1

* NOTE: The doors load is given for closed enclosure in vertical position. The load of doors in open position over angle 120 degrees may damage the enclosure.

Accessories



U400
001102166



UCH-2
001101715



LK-D3-M22*
(3 mm bolt)
001102167



LK-D5-M22
(5 mm bolt)
001102168



LK-KW8-M22
(8 mm square bolt)
001102169



LK-T9-M22
(9 mm triangle bolt)
001102170



LK-1333-M22
001102171



LK-B1333-M22
001102172



LK-CB1333-25-50**
001102180



KEY-D5-M*
001102173



KEY-T9-M
001102174



KEY-KW8-M
001102175



KEY-UNI-M
(For locks D5, T9, KW8, N)
001102176



KEY-1333
001343000



LPE-6
001102177



K-A4
001102178



K-A4-PT
001343200



FA-RAL7035
001101710

*- standard equipment for GT enclosures with 1 and 2 points closing system

**- lock for 3-points closing system for enclosures height ≥ 1000 mm

The rest accessories and equipment can be found in chapter "ACCESSORIES AND INTERNAL CONSTRUCTION SYSTEM" on page 31.

The possibility of equipping the GT enclosures into the SOLID GSX series internal sets

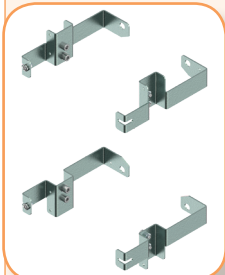

UW/GT internal set
brackets
page. 86

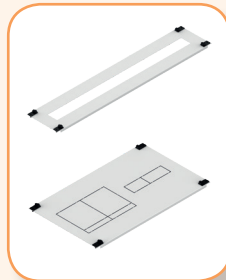

CP covers
page. 72



WP-A / WP-U vertical
supports
page. 85



TH-S rails
page. 80

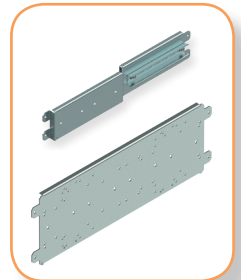

PM mounting plates
page. 80

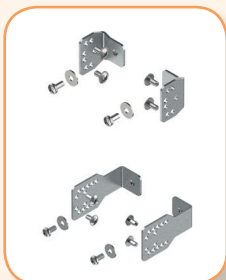

LG-V fixing elements
page. 91

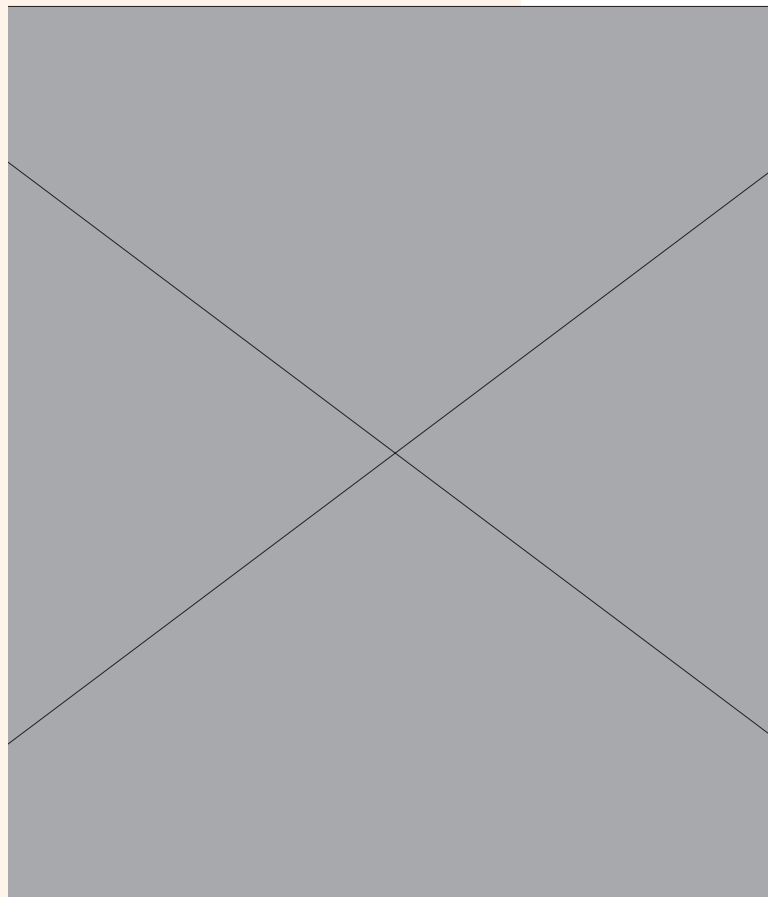

Selected type of equipment that can be mounted according to the assembly instructions in GT enclosures:

Type of equipment	Covers	Mounting plates and rails
Serial terminals	CP x-x F	TH-S x
Non-standard equipment	CP x-x FP	PM x-x PER-A lub PM-F x-24
Modular equipment	CP x-x M	TH-S x
HVL00 / LTL00 disconnectors and modular equipment up to 160 A	CP x-x H00 M	PM x H00 M
KVL00 disconnectors and modular equipment up to 160 A	CP x-x K00 M	PM x K00 M
ED2 / EB2 125, 160, 250 A disconnectors / circuit breakers and modular equipment	CP x-x E12 M	PM x E12 M
LBS1 disconnectors up to 160 A and modular equipment	CP x-x S1 M	PM x E12 M
HVL00 / LTL00 disconnectors up to 160 A	CP x-x H00	PM x H00
KVL00 disconnectors up to 160 A	CP x-x K00	PM x K00
KVL1 disconnectors up to 250 A	CP x-x K1	PM x ELS46 K123
KVL2 disconnectors up to 400 A	CP x-x K2	PM x ELS46 K123
KVL3 disconnectors up to 630 A	CP x-x K3	PM x ELS46 K123
ED2 / EB2 125, 160, 250 A disconnectors / circuit breakers	CP x-x E12	PM x E12 L12
ED2 / EB2 400, 630 A disconnectors / circuit breakers	CP x-x E46	PM x ELS46 K123
LA1 disconnectors up to 160 A	CP x-x L1	PM x E12 L12
LA2 disconnectors up to 250 A	CP x-x L2	PM x E12 L12
LBS1 disconnectors up to 160 A	CP x-x S1	PM x E12 L12
LBS2 disconnectors up to 250 A	CP x-x S2	PM x E12 L12
LBS3 disconnectors up to 630 A	CP x-x S3	PM x ELS46 K123
SL00/1/2/3 strip type fuse-switch-disconnectors	CP x-x SL	-

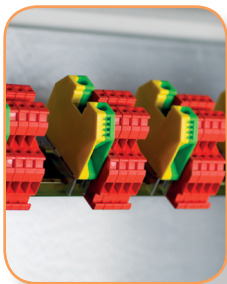

Serial terminals

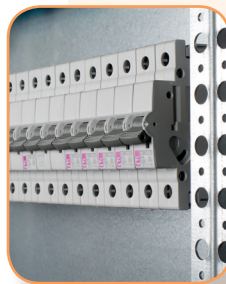

Modular equipment

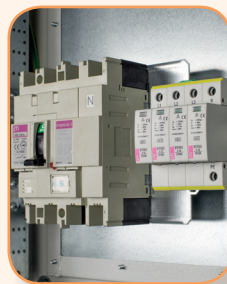

EB2 160 circuit breakers and modular equipment



EB2 400 A circuit breaker



KVL00 disconnector



KVL1 disconnector



EB2 125 A circuit breaker

Dimensions of GT enclosures

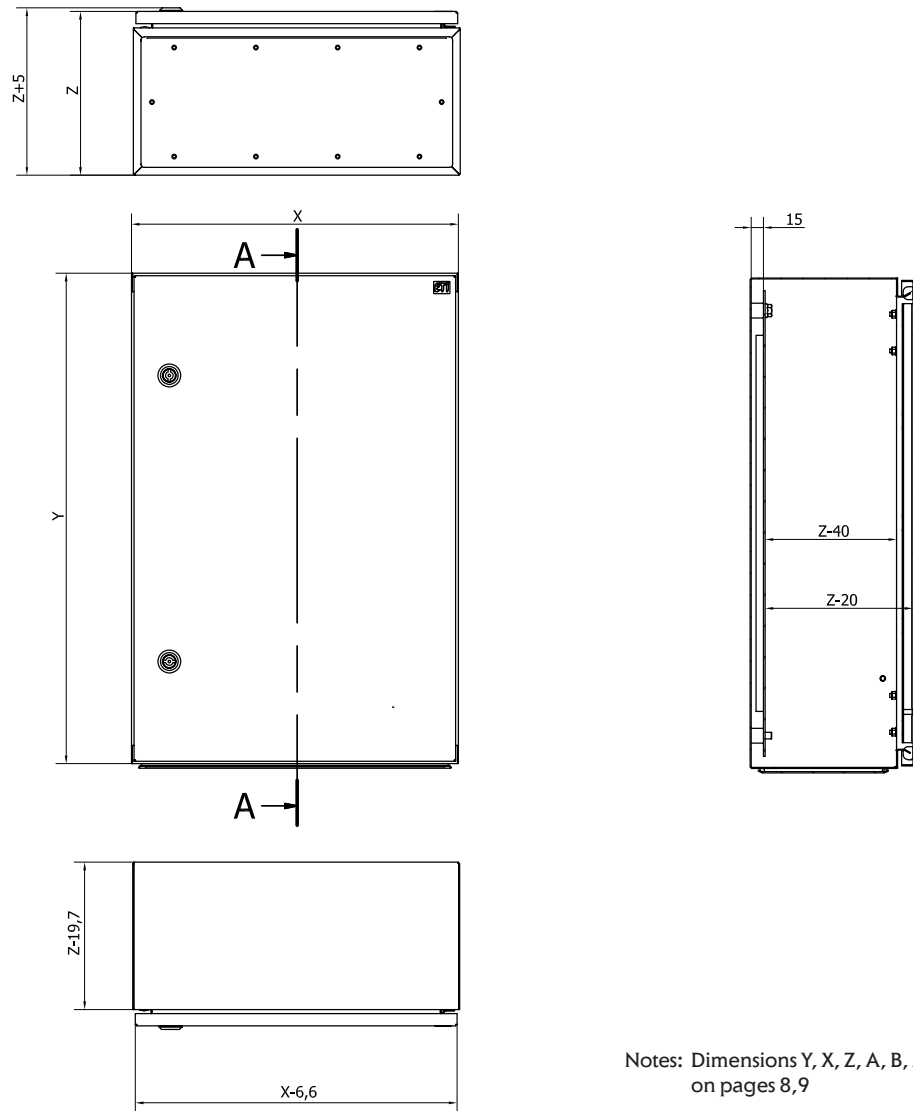

Notes: Dimensions Y, X, Z, A, B, A1, B1 are on pages 8,9

Dimensions of doors

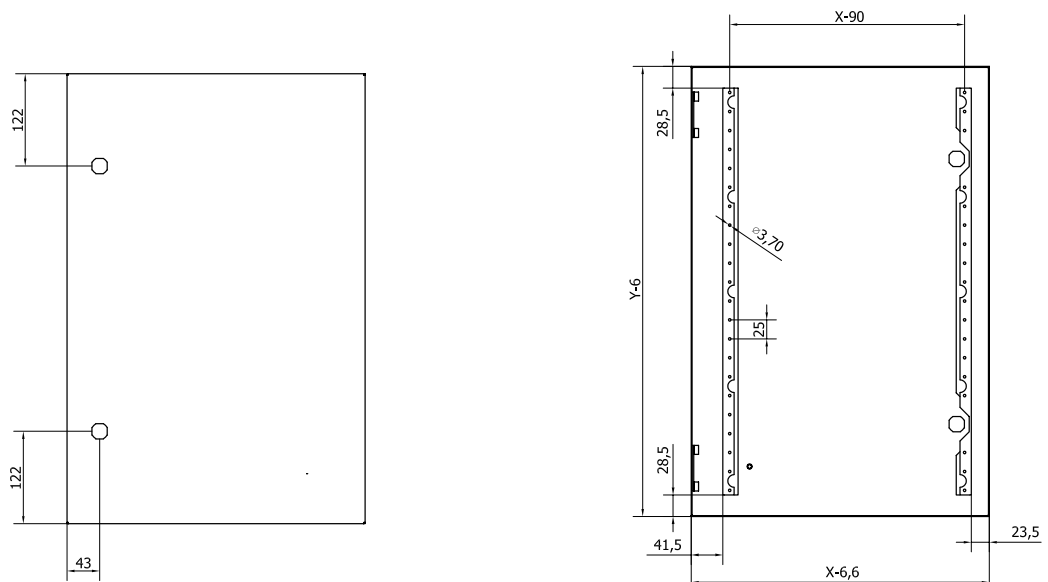

Dimensions of doors

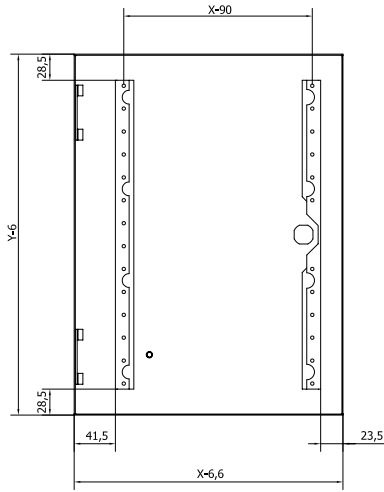

Door with 1-point lock

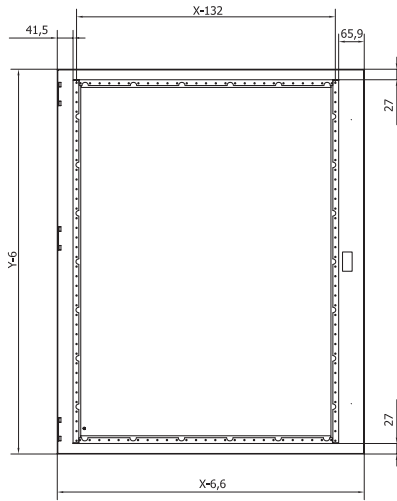

Door with one 3-points lock

Dimensions of the body of enclosure GT

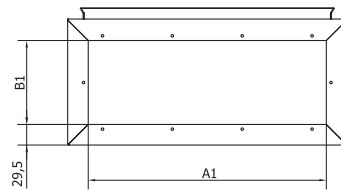
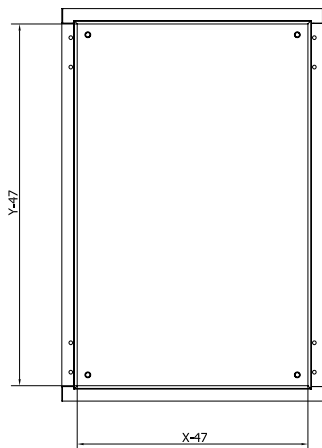
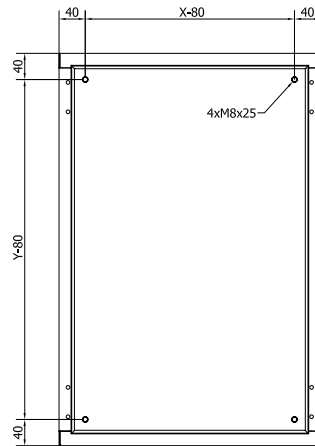
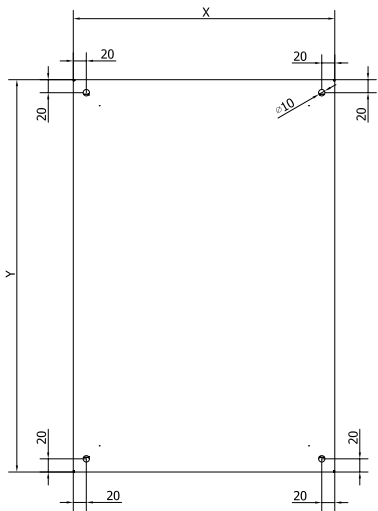

Dimension of cable gland

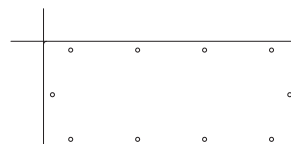

Dimensions of holder, mounting plates, holes for locks

Wall holder U400

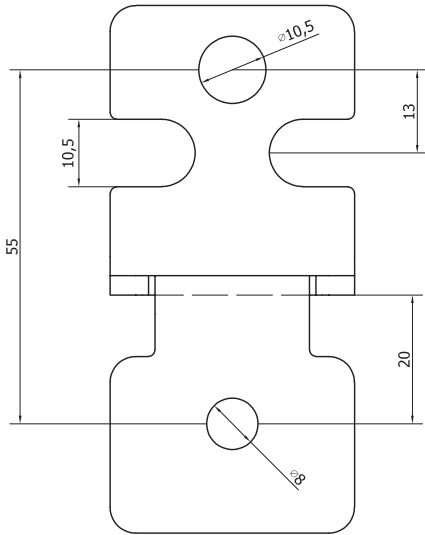

Mounting plates

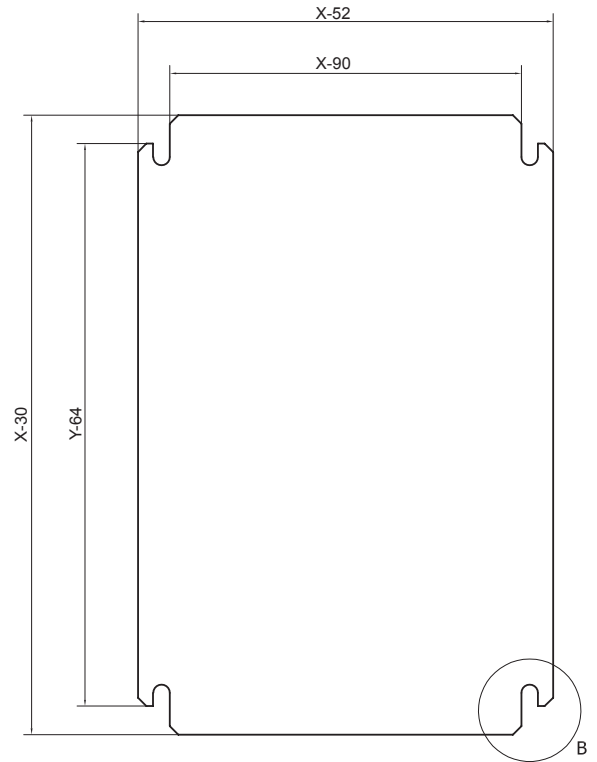

Holes in the door for locks

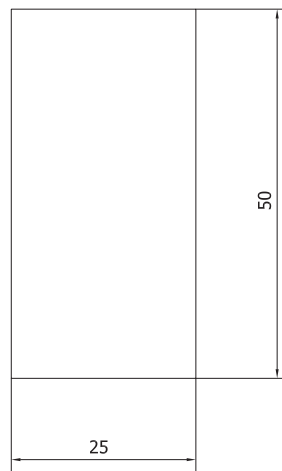
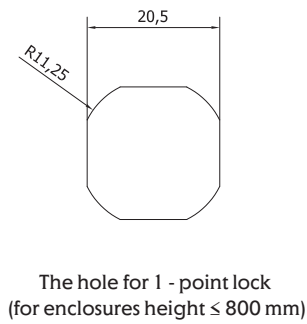

The hole for 3 - points lock
(for enclosures height ≥ 1000 mm)

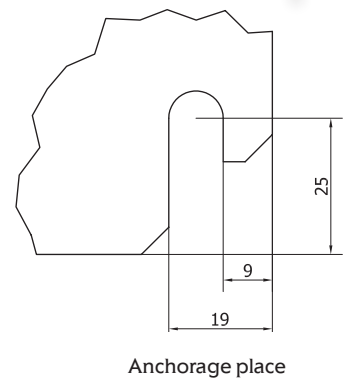

Dimensions of the GT enclosure with UW-GT internal sets brackets

GT enclosures with a depth of 150 mm to 250 mm

GT enclosure depth (mm)	Distance of CP covers from the door (mm)	Distance of CP covers from rear mounting plate (mm)
	A	B
150	50	79
200	66	113
250	78	151

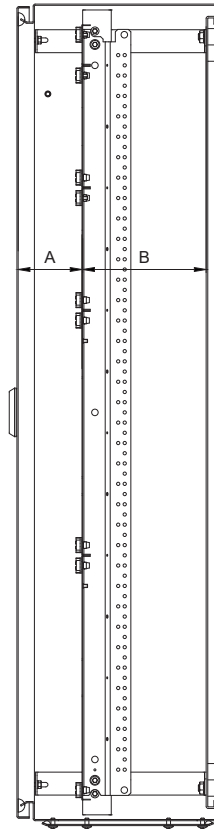

GT enclosures with a depth of 300 mm to 400 mm

GT enclosure depth (mm)	Distance of CP covers from the door (mm)	Distance of CP covers from rear mounting plate (mm)
	A	B
300	min. 59	max. 220
	max. 209	min. 70
400	min. 59	max. 320
	max. 309	min. 70

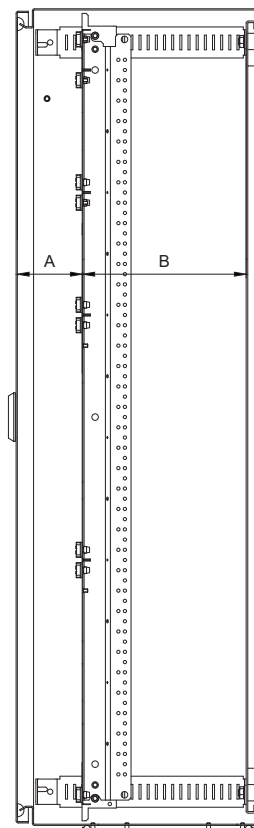

4XN160 (IP41, IP42, IP44) wall mounted and 4XP160 (IP42, IP44) flush mounted enclosures



→ The door can be installed on the left and right side



→ 4XN160 wall mounted and 4XP160 flush mounted enclosures (IP41, IP42, IP44)



→ Flexible membrane gland for cables and wires with diameters from 4 to 32 mm

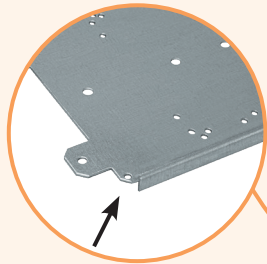

→ All mounting plates have a positioning hole in the bottom left corner



→ The possibility to install mounting rails at an angle



→ The enclosure is complete with locks

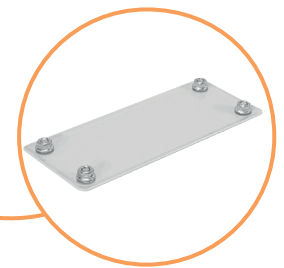

→ The offer includes steel, membrane or aluminum glands



→ All covers have a grounding pin

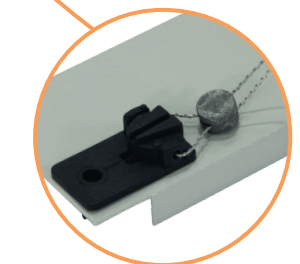

→ The covers have clasps with the possibility of sealing

→ The 4XN160 enclosures can have an IP41, IP42 or IP44 degree of protection

→ The 4XP160 enclosures can have an IP42 or IP44 degree of protection

4XN 160 (IP41, IP42, IP44) wall mounted and 4XP 160 (IP42, IP44) flush mounted enclosures

Advantages:

- High versatility and flexibility
- Removable internal set (can be wired in the workshop or on the site)
- Easy vertical dividing of enclosure by using special separating elements EPW
- Covers and mounting plates are dedicated for ETI devices (MCCB's, MCB's, RCBO's disconnectors, etc.)
- Short assembling time
- Demountable back plate in wall-mounted version
- Demountable door frame in flush-mounted version
- Two door locks with keys in standard equipment (code of key 1333)
- High quality membrane cable flanges
- Elements are precisely made of high quality 1mm thickness sheet steel powder-coated
- Painted with polyester paint - UV resistant

Application:

Metal enclosures are available in two types: wall-mounted 4XN160 with protection degree IP41 (IP42, IP44) depth 160 mm and flush-mounted 4XP160 with protection degree IP42 (IP44), the depth of the cassette 160 mm. Safety class 1.

Technical data

Safety class (total insulation)	I
Protection degree	Wall-mounted 4XN160 - IP41/IP42/IP44 Flush-mounted 4XP160 - IP42/IP44
Degree of protection against mechanical impact	IK10
Rated current	250A
Colour	Light grey (RAL 7035)
Type of paint	Polyester
Application	Indoor use
Ambient temperature	-5°C ... +40°C
Standards	IEC/EN 62208, IEC/EN 60529, IEC/EN 62262
Directives	RoHS

Mechanical load

Mounting framework (WP-A / WP-U + LG-V + TH-S)	125 kg
Mounting plate (PM)	40 kg
Wall mount holders (UCH-2)	200 kg
Doors	7,5 kg

Maximal power dissipation

No.	Type	Description	Max. Δ P (W)
4XN160			
1	4XN160 2-3	Wall-mounted enclosure IP41 (IP42, IP44) empty	69,5
2	4XN160 2-4	Wall-mounted enclosure IP41 (IP42, IP44) empty	83
3	4XN160 2-5	Wall-mounted enclosure IP41 (IP42, IP44) empty	91,7
4	4XN160 2-6	Wall-mounted enclosure IP41 (IP42, IP44) empty	118,6
5	4XN160 2-7	Wall-mounted enclosure IP41 (IP42, IP44) empty	82,5
6	4XN160 3-3	Wall-mounted enclosure IP41 (IP42, IP44) empty	95,2
7	4XN160 3-4	Wall-mounted enclosure IP41 (IP42, IP44) empty	111,7
8	4XN160 3-5	Wall-mounted enclosure IP41 (IP42, IP44) empty	105,2
9	4XN160 3-6	Wall-mounted enclosure IP41 (IP42, IP44) empty	121,6
10	4XN160 3-7	Wall-mounted enclosure IP41 (IP42, IP44) empty	128,7
4XP160			
11	4XP160 2-3	Flush-mounted enclosure IP42 (IP44) empty	57,2
12	4XP160 2-4	Flush-mounted enclosure IP42 (IP44) empty	68,6
13	4XP160 2-5	Flush-mounted enclosure IP42 (IP44) empty	83,7
14	4XP160 2-6	Flush-mounted enclosure IP42 (IP44) empty	88,4
15	4XP160 2-7	Flush-mounted enclosure IP42 (IP44) empty	100,5
16	4XP160 3-3	Flush-mounted enclosure IP42 (IP44) empty	80,4
17	4XP160 3-4	Flush-mounted enclosure IP42 (IP44) empty	98,9
18	4XP160 3-5	Flush-mounted enclosure IP42 (IP44) empty	111,1
19	4XP160 3-6	Flush-mounted enclosure IP42 (IP44) empty	90
20	4XP160 3-7	Flush-mounted enclosure IP42 (IP44) empty	117,4



The advantages and technical characteristics

Wall-mounted enclosures 4XN160

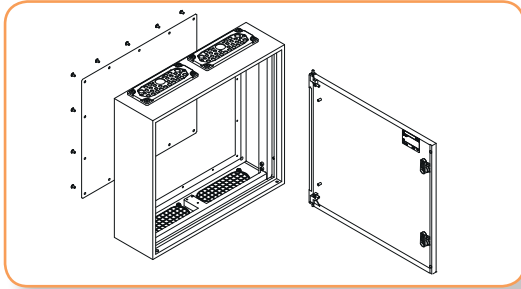

The wall-mounted enclosures consists of body with demountable back plates and non-perforated doors.

Wall-mounted enclosure set is equipped with:

- **plugs of holes for wall-mounting**
- **earthing set - nuts, washers, labels**
- **screws AS-SH 6x10 for fixing vertical brackets WP-A and WP-U**
- **cable membrane flanges – top**
- **plugs of flange holes – bottom**
- **doors with lock sets with keys - code 1333**
- **Allen key Hex5**
- **mounting instruction**

Back plate of wall-mounted enclosure

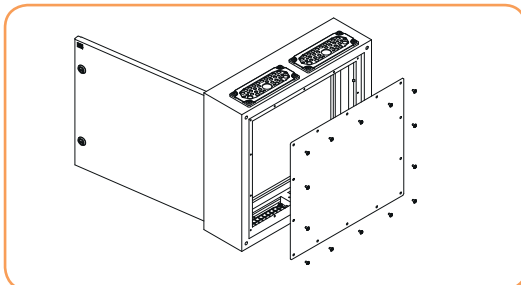

Back plate is made of zinc galvanized sheet steel fastened with sheet metal screws. After demounting of a back plate, there is a possibility of wiring of aparats with an included into enclosure insert.

Mounting wall-mounted enclosure directly to the wall.

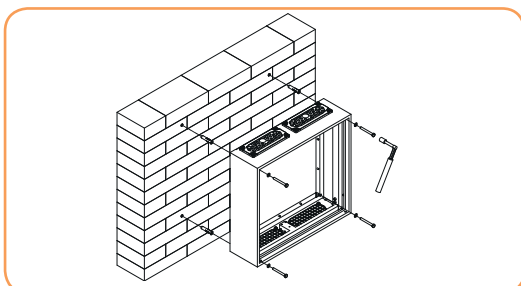

Direct mounting to the wall prevents the removal of the enclosure without opening the door.

Flush-mounted enclosures 4XP160

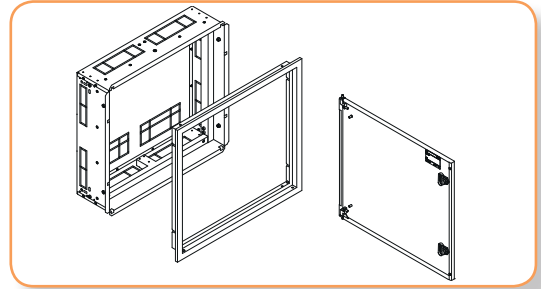

The flush-mounted enclosures consist of a cassette and demountable frame with non-perforated doors.

Flush-mounted enclosure is equipped with:

- earthing set - nuts, washers, labels, screws M6x10
- screws AS-SH 6x10 for fixing vertical brackets WP-A and WP-U
- screws M6x40 with locknuts for cassette positioning (placement)
- doors with frame, lock sets with keys - code 1333
- Allen key Hex5
- mounting instruction

Door mounting in enclosure

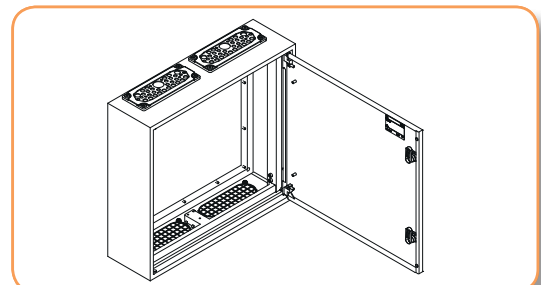

Special hinges - the door can be mounted without tools. The doors can be changed on the left or right, both at wall- and flush-mounted enclosures.

Mounting wall-mounted enclosure to the wall with holders UCH-2

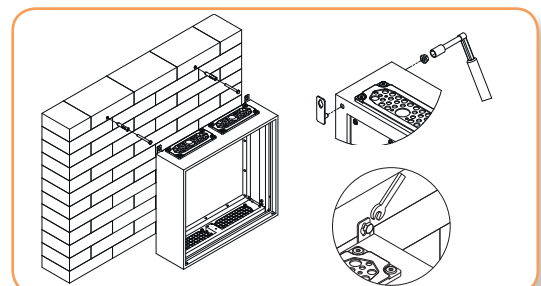

External holders makes the enclosure hanging easy.

Flush-mounting cassette

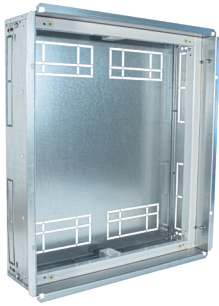

Made of 1 mm thick galvanized sheet steel. A very rigid structure.

It has weakness to cut holes through which the cables are placed.

The cassette has holes for fixing in the cavity.

M6x40 screws are supplied along complete with the cassette for positioning only.

Final fixing done by fixing bolts (in the cassette $\varnothing 9$ mm holes and bean holes 6 mm) and mounting foam (additional holes for the foam insert).

Cassette assembly in the cavity

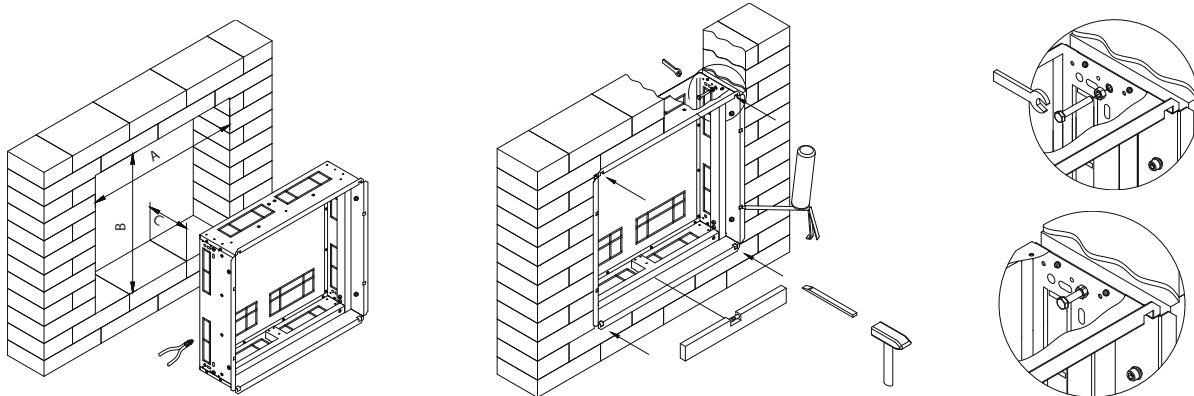

Suggested dimensions of the cavity are shown in the table on p. 19

Fixing the door frame

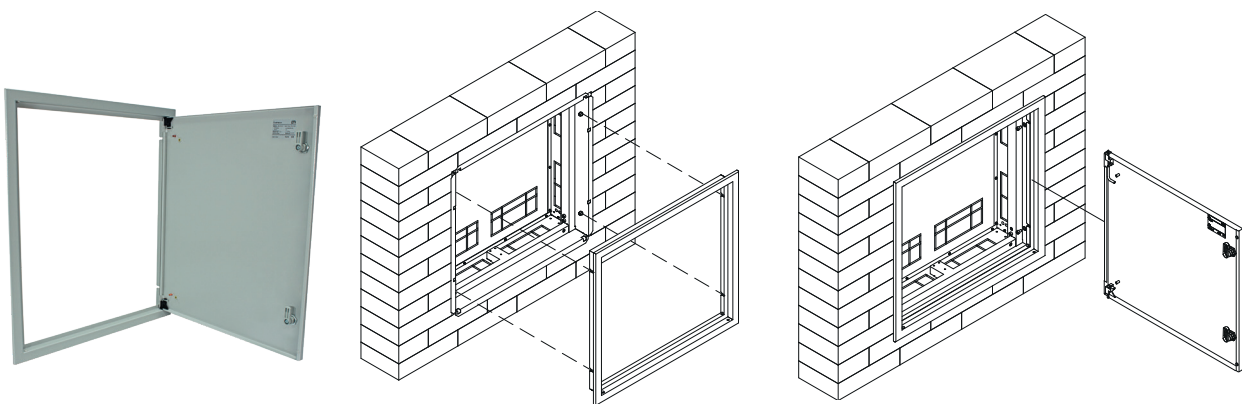

Door frame with door is screwed after the cassette assembly.

Fixing takes place with bolts, where you can adjust the vertical location approx. 20 mm. There is the possibility of a few percent adjustment from the plane of the door frame relative to the cassette back to compensate inaccuracies in work.

Doors can be open from left or right side.

Note! Frame with doors and cassette are sold in one set. (one code number)

Locks for doors



Enclosure doors are equipped as a standard with two patent locks key with code 1333 in light gray (RAL 7035). You can change the locks on any available in the ETI offer called LK... M22.

Holes for cable glands

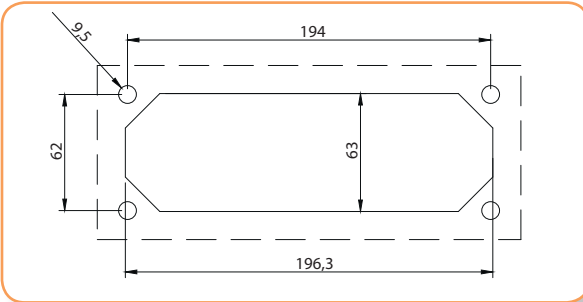

Wall-mounted enclosures have holes for cable glands (standard FL21). In the case of top standard cable glands are installed membrane EH-TKC-36, while at the bottom of the enclosure there are plastic plugs installed in the holes. In the case of approach leads from the bottom of the housing can rotate 180 degrees. The range includes steel and aluminum membrane glands.

Membrane gland



The use of modern glands allows the introduction of wires without single cable glands and without the use of special tools.

Steel/aluminium gland

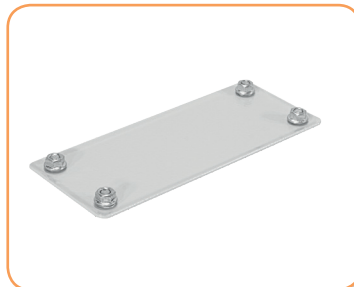

It allows to use cables and wires with larger cross-sections (appropriate cable glands).

Metal gland with gasket



It allows to use cables and wires with larger cross sections and it keeps higher IP protection.

Degree of protection IP



Wall-mounted enclosures 4XN160:

- without seals IP41
- with the seal back cover IP42
- with the seal back cover and door IP44

Flush-mounted enclosures 4XP160 (frame with a door):

- without door seal IP42
- with door seal IP44

Normally, without additional sealing, wall-mounted enclosures 4XN160 have a degree of protection IP41, while flush-mounted have IP42. Additional sealing of the back of wall-mounted and the door of flush-mounted is made by glue SEAL -G9. It is glued by the customer according to instruction.

Seal lengths are given in Tables (page 18).



For achieve proper degree of protection, space between door frame and the wall should be sealed by silicone sealant.

The length of the seals ensuring an appropriate level of IP protection

Wall-mounted enclosures		
Type	Total length of the seal (m) for IP 42	Total length of the seal (m) for IP 44
4XN160 2-3	1,8	3,8
4XN160 2-4	2,1	4,4
4XN160 2-5	2,4	5
4XN160 2-6	2,7	5,6
4XN160 2-7	3	6,2
4XN160 3-3	2,3	4,8
4XN160 3-4	2,6	5,4
4XN160 3-5	2,9	6
4XN160 3-6	3,2	6,6
4XN160 3-7	3,5	7,2

Flush-mounted enclosures	
Type	Total length of the seal (m) for IP 44
4XP160 2-3	2,2
4XP160 2-4	2,5
4XP160 2-5	2,8
4XP160 2-6	3,1
4XP160 2-7	3,4
4XP160 3-3	2,7
4XP160 3-4	3
4XP160 3-5	3,3
4XP160 3-6	3,6
4XP160 3-7	3,9

The earthing circuit

Metal enclosures 4XN160 / 4XP160 ensure the continuity of the protective electrical circuit connections through conductive metal parts of the housing. Additionally, M6 (8 pcs.) nuts are welded to the cassette and simultaneously they are used to fastening the vertical bracket (WP-A / HR-U) and to the connection the protective conductor.

External ground conductor can be connected to the main terminal installed by the switchgear manufacturer (main terminal PE, PE distribution block) or directly to the welded nuts M6 (screw DIN912 Type AS-SH 6x10 delivered complete with enclosure, torque 5 Nm). In the case of the external protective circuit is connected to the main terminals PE or PE distribution block it must be also connected to the welded M6 nuts.



If there is electrical equipment on the door LPE-6 wire must be used to connect the protective circuit with the door. For this purpose both the frame and door have welded copper-plated pins M6x12.

Enclosures are delivered to the customer without distribution blocks, PE protective terminals and neutral N.

Overview Heights/Widths- Internal dividing for enclosures 4XN160 and 4XP160

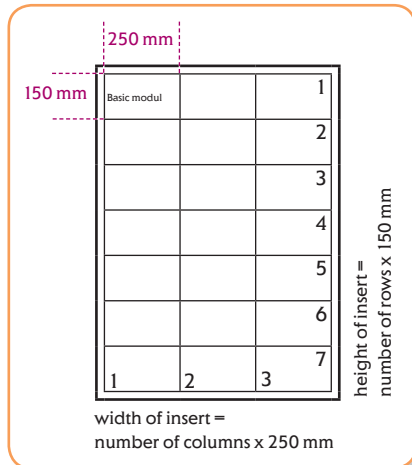

Range of sizes is based on DIN 43870 standard. Base module with devices cover has a width of 250 mm and a height of 150 mm. In this module you can install 12 modular devices with a width 18 mm. A code for the basic fields represent two digits separated by a dash of 1-1, where the first digit describes the width and the second height. Other sizes multiples the basic fields (eg. 2-3 cover mean- width 500 mm, height 450 mm). 4XN160 wall-mounted enclosures and 4XP160 flush-mounted occur in two window widths 2 and 3 (500 mm and 750 mm) and height 3, 4, 5, 6, 7 (450 mm, 600 mm, 750 mm, 900 mm, 1050 mm). Enclosures with width 2 can be divided in vertical configuration 1 + 1. In contrast, the width of the enclosure 3 can be divided in the configuration of 1 + 1 + 1, 2 + 1 or 1 + 2.

Naming method for 4XN160 and 4XP160 enclosures:

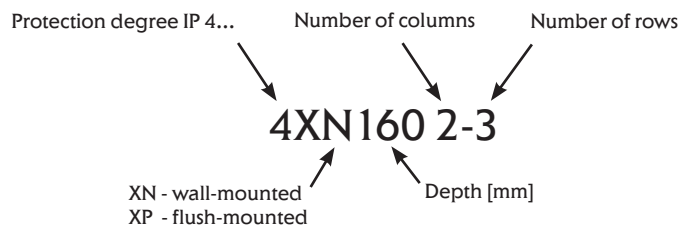

Enclosure types						External enclosure dimensions			Cavity suggested dimensions			
No.	Type	Description	Code no.	The maximum number of modules		Width (mm)	Height (mm)	Depth (mm)	Width (mm)	Height (mm)	Depth (mm)	Weight (kg)
4XN160												
1	4XN160 2-3	Wall-mounted enclosure IP41 empty	001101400	3x24 mod.	72	550	500	160	-	-	-	9,67
2	4XN160 2-4	Wall-mounted enclosure IP41 empty	001101401	4x24 mod.	96	550	650	160	-	-	-	11,77
3	4XN160 2-5	Wall-mounted enclosure IP41 empty	001101402	5x24 mod.	120	550	800	160	-	-	-	13,87
4	4XN160 2-6	Wall-mounted enclosure IP41 empty	001101403	6x24 mod.	144	550	950	160	-	-	-	15,96
5	4XN160 2-7	Wall-mounted enclosure IP41 empty	001101404	7x24 mod.	168	550	1100	160	-	-	-	18,05
6	4XN160 3-3	Wall-mounted enclosure IP41 empty	001101405	3x36 mod.	108	800	500	160	-	-	-	12,91
7	4XN160 3-4	Wall-mounted enclosure IP41 empty	001101406	4x36 mod.	144	800	650	160	-	-	-	15,61
8	4XN160 3-5	Wall-mounted enclosure IP41 empty	001101407	5x36 mod.	180	800	800	160	-	-	-	18,30
9	4XN160 3-6	Wall-mounted enclosure IP41 empty	001101408	6x36 mod.	216	800	950	160	-	-	-	21,01
10	4XN160 3-7	Wall-mounted enclosure IP41 empty	001101409	7x36 mod.	252	800	1100	160	-	-	-	24,23
4XP160												
11	4XP160 2-3	Flush-mounted enclosure IP42 empty	001101410	3x24 mod.	72	610	560	160	581	525	170	11,20
12	4XP160 2-4	Flush-mounted enclosure IP42 empty	001101411	4x24 mod.	96	610	710	160	581	675	170	13,51
13	4XP160 2-5	Flush-mounted enclosure IP42 empty	001101412	5x24 mod.	120	610	860	160	581	825	170	15,72
14	4XP160 2-6	Flush-mounted enclosure IP42 empty	001101413	6x24 mod.	144	610	1010	160	581	975	170	18,04
15	4XP160 2-7	Flush-mounted enclosure IP42 empty	001101414	7x24 mod.	168	610	1160	160	581	1125	170	20,30
16	4XP160 3-3	Flush-mounted enclosure IP42 empty	001101415	3x36 mod.	108	860	560	160	831	525	170	14,68
17	4XP160 3-4	Flush-mounted enclosure IP42 empty	001101416	4x36 mod.	144	860	710	160	831	675	170	17,56
18	4XP160 3-5	Flush-mounted enclosure IP42 empty	001101417	5x36 mod.	180	860	860	160	831	825	170	20,34
19	4XP160 3-6	Flush-mounted enclosure IP42 empty	001101418	6x36 mod.	216	860	1010	160	831	975	170	23,24
20	4XP160 3-7	Flush-mounted enclosure IP42 empty	001101419	7x36 mod.	252	860	1160	160	831	1125	170	26,63

Elements of wall mounted enclosure 4XN160 (standard equipment)

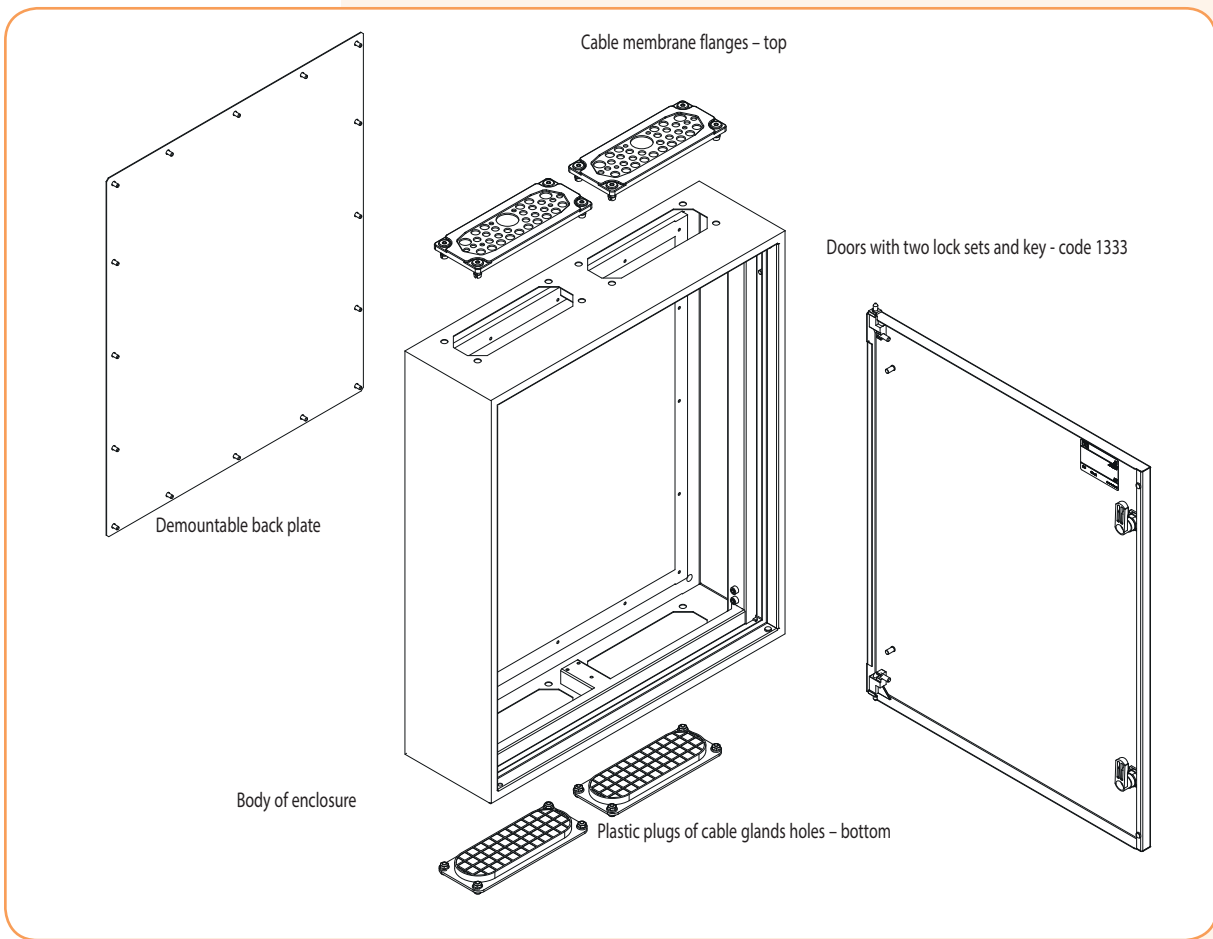

Elements of flush mounted enclosure 4XP160 (standard equipment)

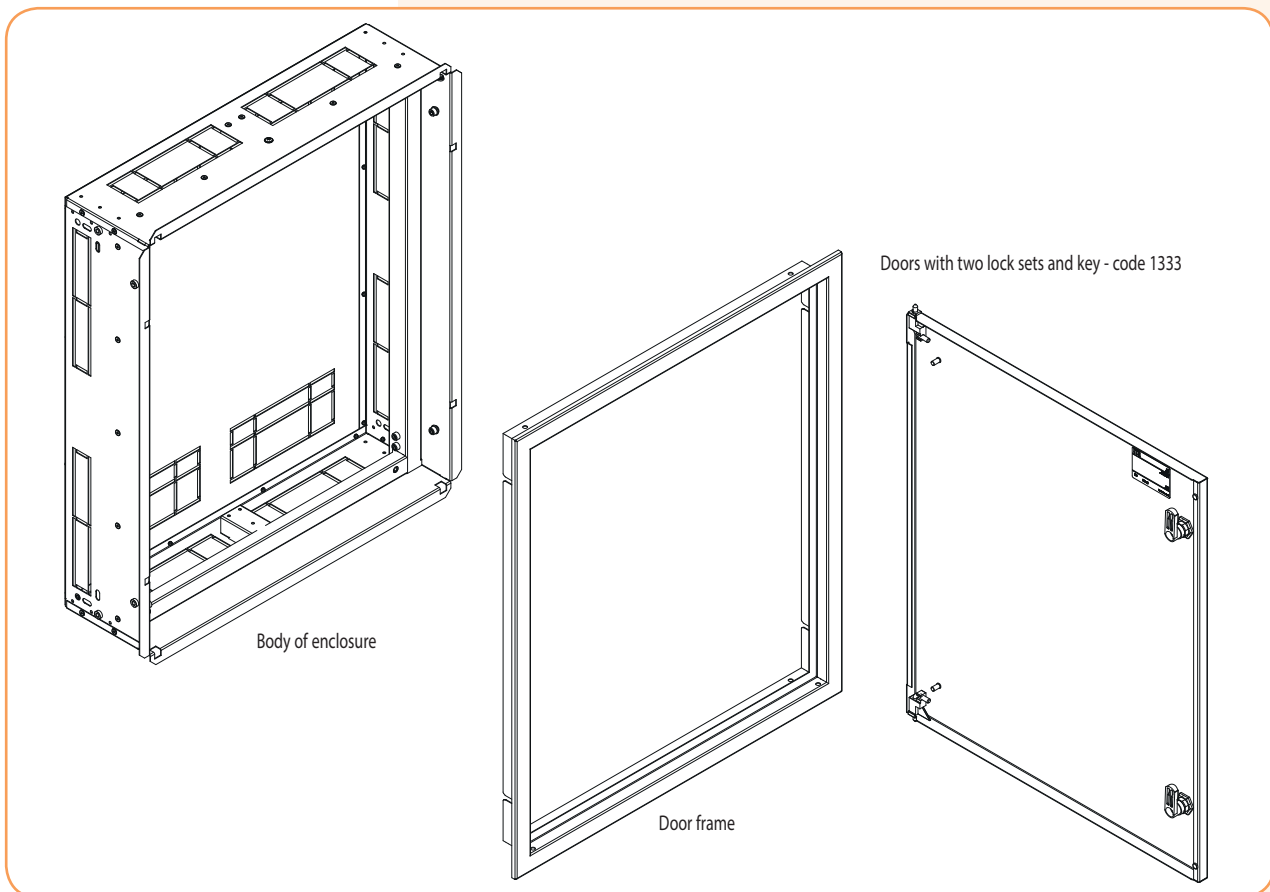

Accessories for 4XN160 and 4XP160 enclosures



U400
001102166



UCH-2
001101715



LK-D3-M22
(sworzeń-3 mm)
001102167



LK-D5-M22
(5 mm bolt)
001102168



LK-KW8-M22
(sworzeń kwadrat-8 mm)
001102169



LK-T9-M22
(9 mm triangle bolt)
001102170



LK-1333-M22
001102171



LK-B1333-M22
001102172



LK-1333-M22
RAL7035 *
001101718



KEY-D5-M
001102173



KEY-T9-M
001102174



KEY-KW8-M
001102175



KEY-UNI-M
(For D5, T9, KW8, N locks)
001102176



KEY-1333
001343000



LPE-6
001102177



K-A4
001102178



K-A4-PT
001343200



FA-RAL7035
001101710

* - standard equipment

The rest accessories and equipment can be found in chapter "ACCESSORIES AND INTERNAL CONSTRUCTION SYSTEM" on page 31.

Internal set for 4XN160 and 4XP160 enclosures

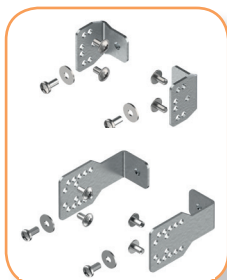

Fixing elements LG-V
page. 91

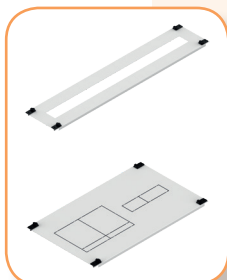

CP covers
page. 72

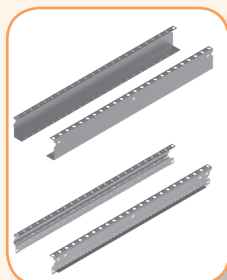

Vertical supports
WP-A /WP-U
page. 85



TH-S rails
page. 80

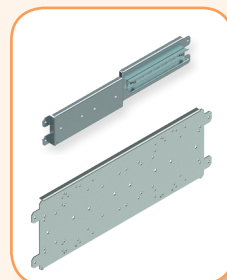

PM mounting plates
page. 80

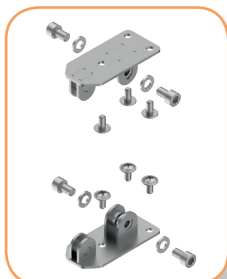

EP-W dividing elements
page. 87

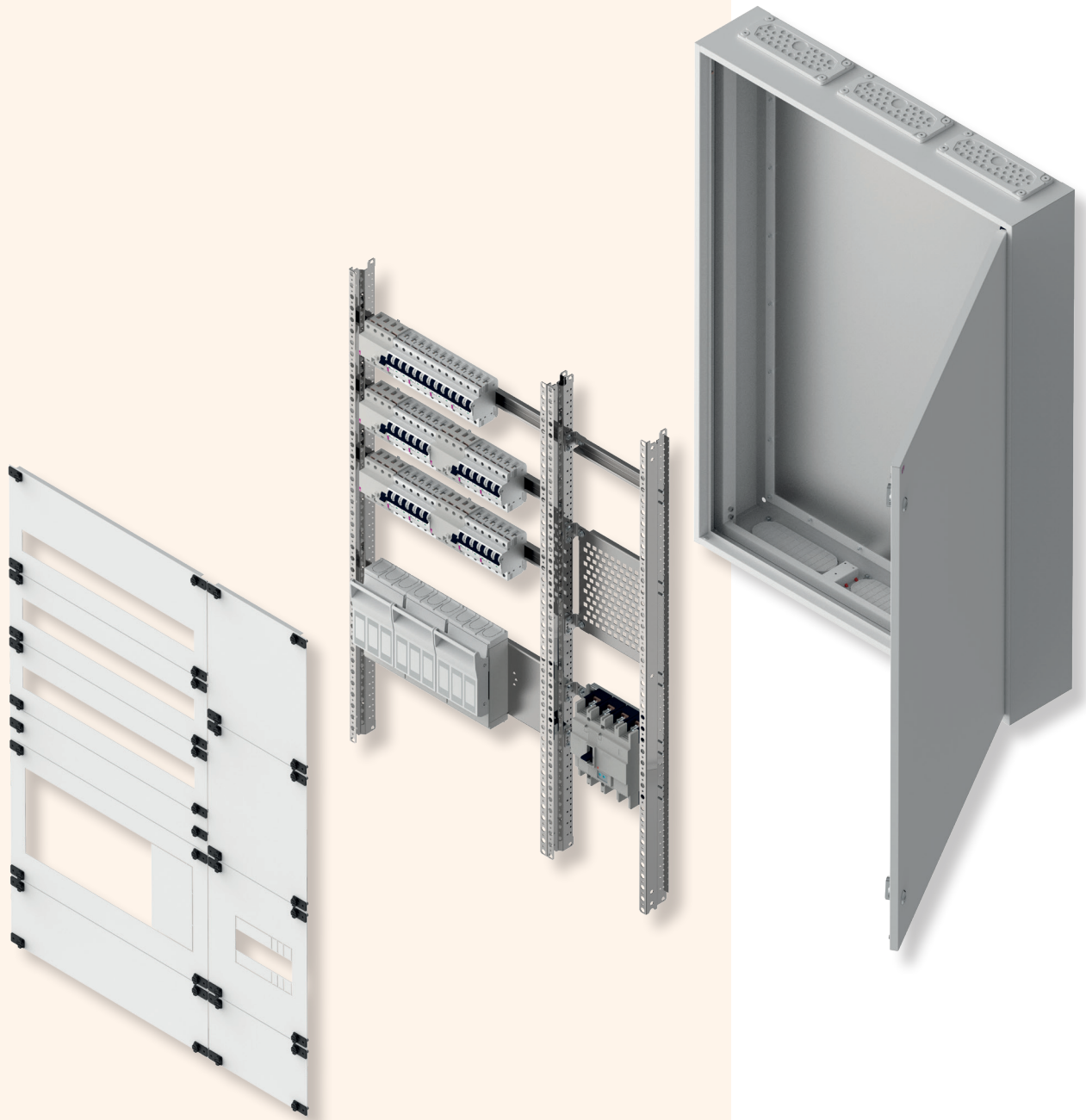
Internal equipment of 4XN160 wall mounted and 4XP160 flush mounted enclosures

Selected type of equipment that can be mounted according to the assembly instructions in 4XN160 and 4XP160 enclosures:

Type of equipment	Covers	Mounting plates and rails
Serial terminals	CP x-x F	TH-S x
Non-standard equipment	CP x-x FP	PM x-x PER-A lub PM-F x-24
Modular equipment	CP x-x M	TH-S x
HVL00 / LTL00 disconnectors and modular equipment up to 160 A	CP x-x H00 M	PM x H00 M
KVL00 disconnectors and modular equipment up to 160 A	CP x-x K00 M	PM x K00 M
ED2 / EB2 125, 160, 250 A disconnectors / circuit breakers and modular equipment	CP x-x E12 M	PM x E12 M
LBS1 disconnectors up to 160 A and modular equipment	CP x-x S1 M	PM x E12 M
HVL00 / LTL00 disconnectors up to 160 A	CP x-x H00	PM x H00
KVL00 disconnectors up to 160 A	CP x-x K00	PM x K00
KVL1 disconnectors up to 250 A	CP x-x K1	PM x ELS46 K123
ED2 / EB2 125, 160, 250 A disconnectors / circuit breakers	CP x-x E12	PM x E12 L12
LA1 disconnectors up to 160 A	CP x-x L1	PM x E12 L12
LA2 disconnectors up to 250 A	CP x-x L2	PM x E12 L12
LBS1 disconnectors up to 160 A	CP x-x S1	PM x E12 L12

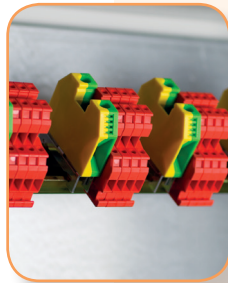

Serial terminals

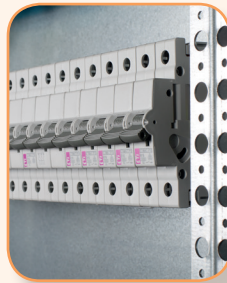

Modular equipment

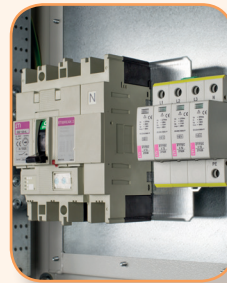

EB2 160 circuit breaker and modular equipment



KVL00 disconnector



EB2 125 A circuit breaker



LBS 160 A disconnector

Dimensional drawings

Body of wall mounted 4XN160 enclosures

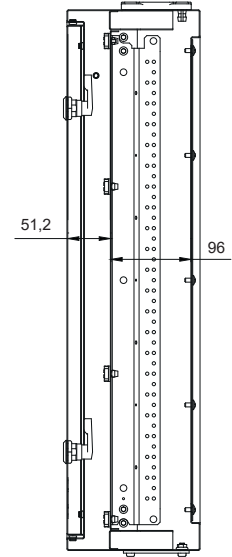
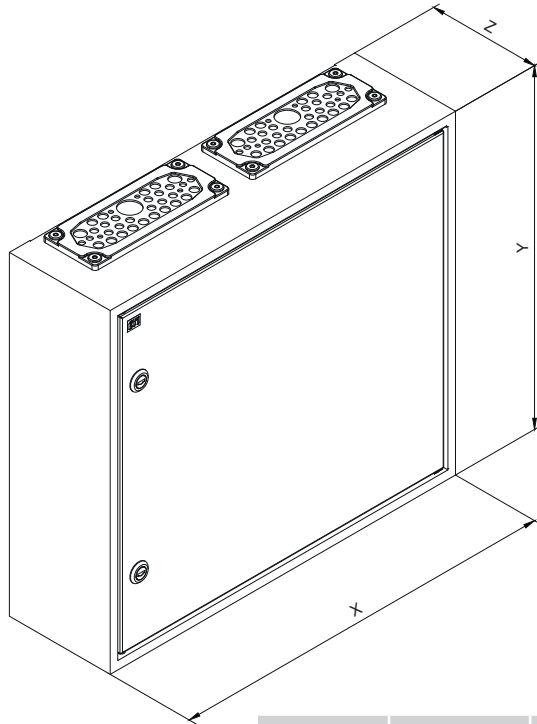

Type	X (mm)	Y (mm)	Z (mm)
4XN160 2-3	550	500	160
4XN160 2-4	550	650	160
4XN160 2-5	550	800	160
4XN160 2-6	550	950	160
4XN160 2-7	550	1100	160
4XN160 3-3	800	500	160
4XN160 3-4	800	650	160
4XN160 3-5	800	800	160
4XN160 3-6	800	950	160
4XN160 3-7	800	1100	160

Holes for cable glands

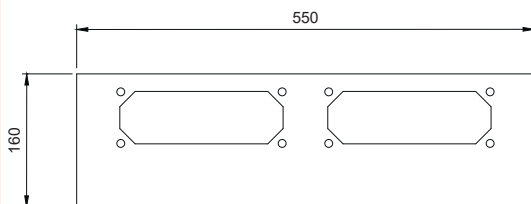

4XN160 2-x

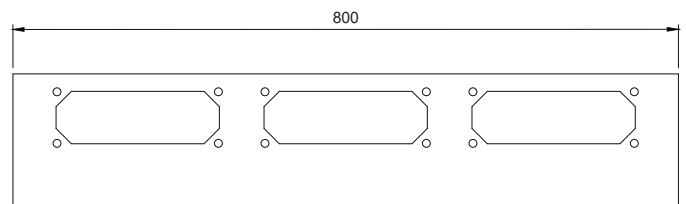

4XN160 3-x

Cable gland hole - standard C (FL 21)

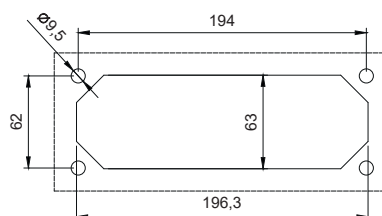

Body of wall mounted 4XP160 enclosures

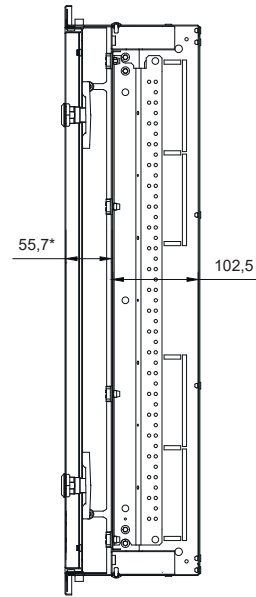
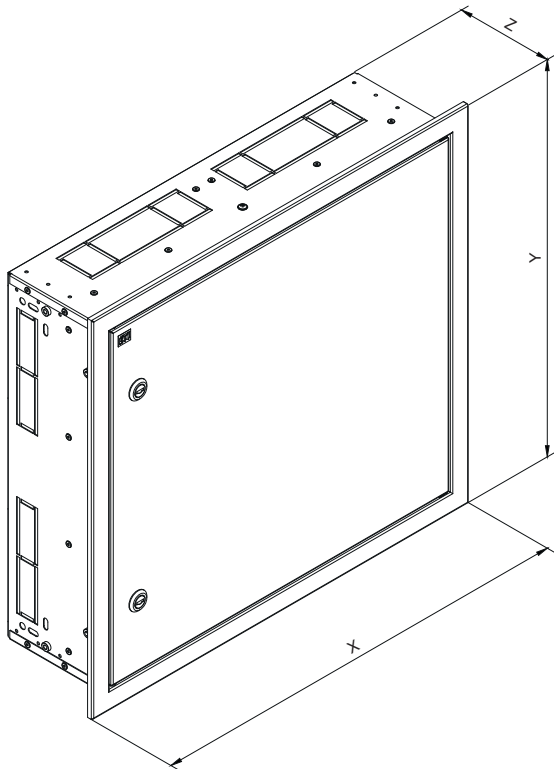

*frame adjustment +15 mm

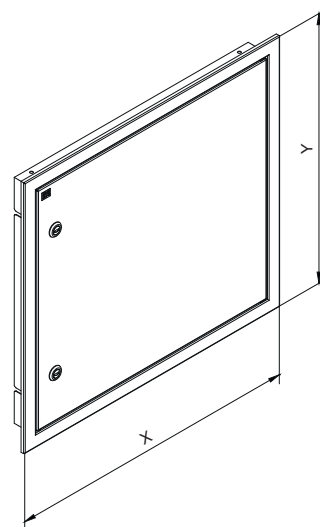
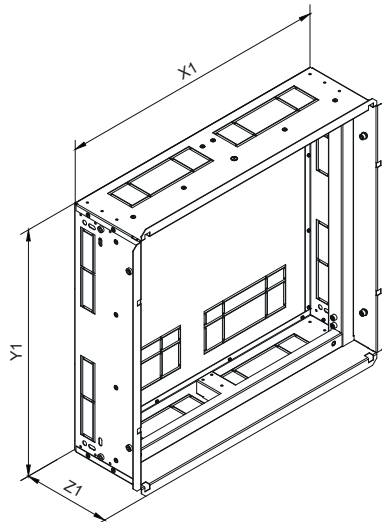
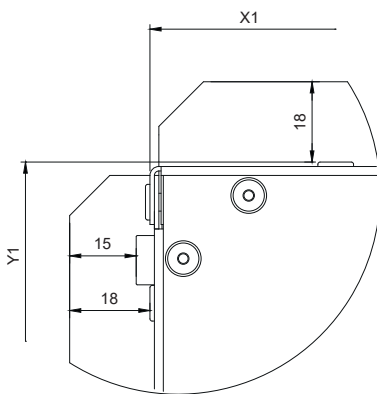

Type	X (mm)	Y (mm)	Z (mm)	X1 (mm)	Y1 (mm)	Z1 (mm)
4XP160 2-3	608	558	163	564	514	161
4XP160 2-4	608	708	163	564	664	161
4XP160 2-5	608	858	163	564	814	161
4XP160 2-6	608	1008	163	564	964	161
4XP160 2-7	608	1158	163	564	1114	161
4XP160 3-3	858	558	163	814	514	161
4XP160 3-4	858	708	163	814	664	161
4XP160 3-5	858	858	163	814	814	161
4XP160 3-6	858	1008	163	814	964	161
4XP160 3-7	858	1158	163	814	1114	161

INTERNAL STRUCTURAL SYSTEM AND ACCESSORIES

Components - Internal structural system and accessories

- Covers CP plain and modular
- Covers CP dedicated to ETI equipment
- Mounting plates PM
- Mounting rails TH-S
- Vertical brackets WP-A and WP-U
- Dividing element EPW
- Mounting elements LG-V and LG-V5
- Screws, nuts, washers
- Holders UW-GT and UCH-2
- Cable glands
- Pocket for documents, seals, pliers
- Locks
- Keys

Advantages:

- CP covers and PM mounting plates are dedicated to ETI devices (disconnectors, MCCB's modular equipment – perforated plates and covers are prepared to quick cut-outs the holes
- Quick and easy covers installation the use of special sealable clips
- CP covers earthing pins ensure protection against electric shock
- The possibility of vertically dividing the enclosure through EPW element. Insert is installed in very simple way
- Vertical brackets: WP-A enables the installation of equipment at various depths and WP-U without adjusting the depth and without the possibility of dividing the enclosure (economical version)
- Universal sheet metal screws for fixing brackets, mounting plates, rails TH
- Possibility of mounting rail TH at an angle
- Different Types of locks matching the entire system GSX
- Metal enclosures painted with polyester paint resistant to UV radiation

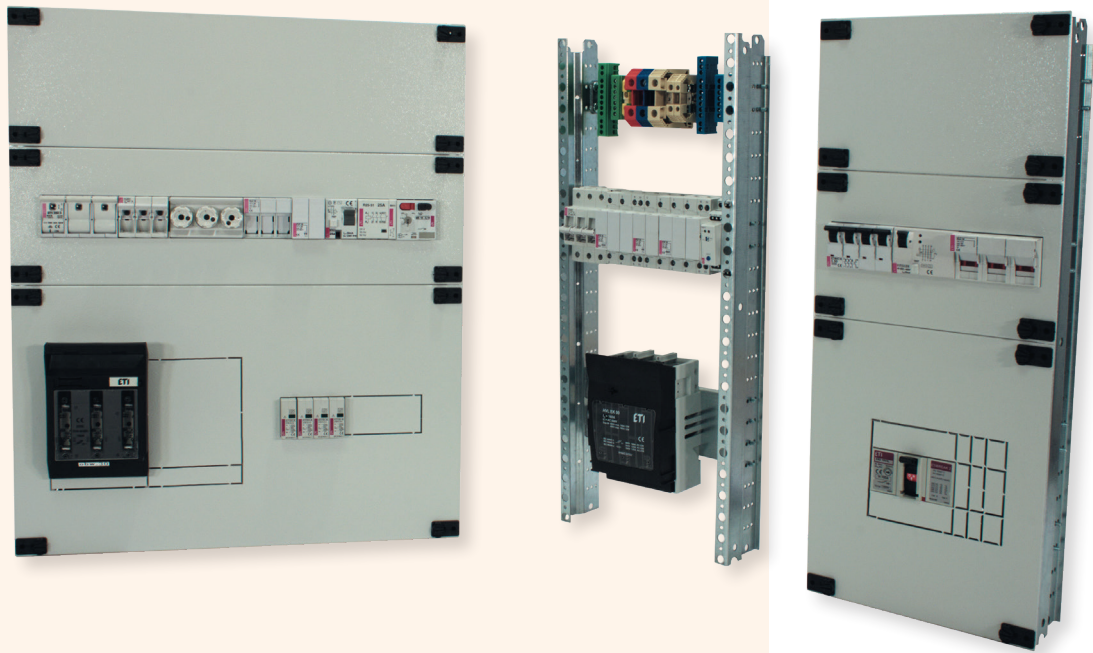

We also offer a software tool to help you select appropriate components SOLID GSX Configurator, which is available for download on our website

Vertical bracket WP-U



Vertical bracket economical version offers no possibility of the enclosure division and mounting depth TH-S rails adjustment as well as mounting plates PM. The same distance (48.5 mm) from rails TH-S to covers. Rails TH-S and plates PM are directly mounted to the bracket WP-U by means of sheet metal screws AST 4.8x9.5 without the use of fasteners LG-V. The brackets are attached to the enclosure with Allen screws M6x10 supplied along with the enclosure.

Brackets are packaged in sets of 2 pieces.

Vertical bracket WP-A

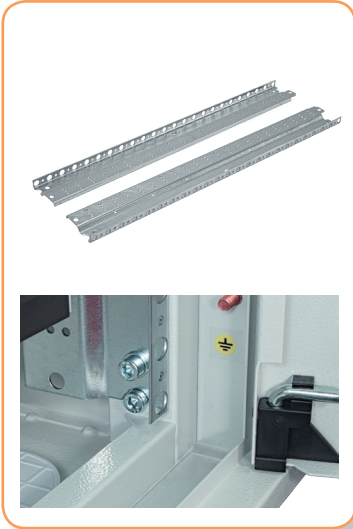

The special design of the vertical brackets WP-A enables the installation of equipment at various depths. Adjustment is possible due to the brackets perforation and elements LG-V, LG-V5. Mounting rails TH-S, and PM mounting plates are fixed to LG-V, LG-V5 elements. Plates and rails are screwed to the elements LG-V with metric screws. The design of the vertical bracket WP-A enables users to adjust mounting rails TH-S, mounting plates PM and covers CP. Vertical adjustment is made with step 25 mm, while the depth regulation for rails TH-S and mounting plates PM is 8 mm or alternately 6 mm or 2 mm (this is done by additional holes in the elements LG-V and LG-V5).

Slots in brackets to enable the choice of the distance between devices and covers.

On the bracket WP-A additional holes were applied to determine easy mounting position for rails TH-S and plates PM. Hole pitch is 150 mm and 75 mm.

The brackets are attached to the body with the supplied Allen hex screws M6x10 along with the enclosure.

Brackets are packaged in one set (left and right).

Mounting elements LG-V

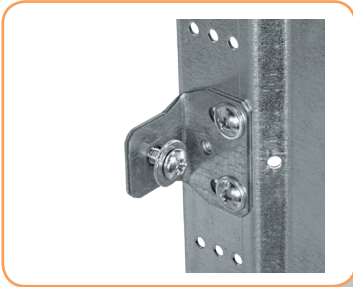

LG-V elements are used to fix the rails TH-S and mounting plates PM to vertical bracket WP-A. It is done with the help of two sheet metal screws (AST 4.8x9.5). The LG-V element contains a metric nut M5.

TH-S rails and mounting plates PM are attached to the element LG-V using metric screws M5 (AS-C 5x10) with washer (AW-RE5). LG-V element should be used for mounting rails TH-S designed for modular equipment, mounting plates PM H00 M (for disconnectors LTL00 / HVL00 and modular equipment), PM ... E12 M (for disconnectors ED2/circuit breakers EB2 125A, 160A, 250A and modular equipment), PM ... H00 (for disconnectors LTL00 / HVL00), mounting plates PM..E12 L12 (for disconnectors ED2/circuit breakers EB2 125A, 160A, 250A). Fixing one TH-S rail is made by 2 pieces of LG-V (1 x set LG-V SET). Fixing plates PM by means of 4 pieces LG-V (2 x set LG-V SET). Minimum distance from mounting plane to the cover is 57,5 mm, the maximum offset is 79,5 mm.

LG-V element are packed: 50 pieces as a single element without sheet metal screws, metric screws and washers or as a set (SET) containing 2 pieces of LG-V, 4 sheet metal screws, 2 washers and 2 metric screws M5.

Mounting elements LG-V5

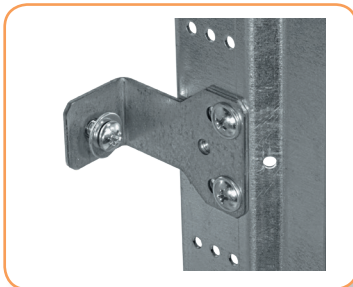

LG-V5 elements are used to fix the rails TH-S and mounting plates PM to vertical bracket WP-A. It is done with the help of two sheet metal screws (AST 4.8x9.5). The LG-V element contains a metric nut M5.

TH-S rails and mounting plates PM are attached to the element LG-V using metric screws M5 (AS-C 5x10) with washer (AW-RE5). LG-V5 element should be used for mounting rails TH-S with terminals, PM ... E12 L12 (position 1 for disconnectors LA1 and position 1 and 4 for disconnectors LA2). The items are shown in the mounting instructions CP X-2 L1 and CP X-2. Fixing one TH-S rail is made by 2 pieces of LG-V5 (1 x set LG-V5 SET), mounting plates PM by 4 pieces LG-V5 (2 x set LG-V5 SET). Minimum distance from mounting plane to the cover is 85 mm, the maximum offset is 107 mm.

LG-V5 element are packed: 20 pieces as a single element without sheet metal screws, metric screws and washers or as a set (SET) containing 2 pieces of LG-V5, 4 sheet metal screws, 2 washers and 2 metric screws M5.

Dividing set EPW

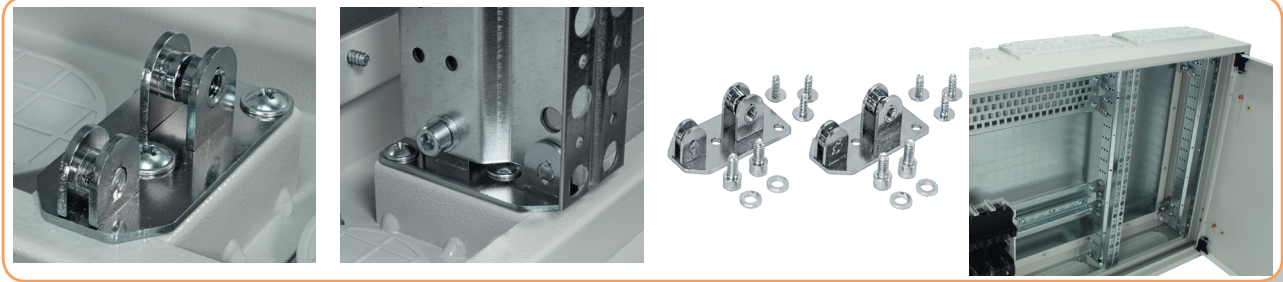

An important advantage of our system is the possibility to split enclosures vertically by means of a set of EPW and vertical bracket WP-A. This enables to create separate space for compartment cable or media.

It is not possible divide the enclosure with the vertical bracket WP-U (economical version without the possibility to adjust the depth of TH-S rails, plates PM and the possibility to dividing the enclosure into sections).

EPW dividing set contains: 2 pieces of dividing elements, 6 sheet metal screws, 4 x Allen screws M6x10 and 4 washers.

Sheet metal screw



An important element of the system is a special sheet metal screw AST 4.8x9.5 with Philips head PH2. If is used to fix elements LG-V / LG-V5 to the s WP-A, WP-U, TH-S rails, mounting plates PM, cable glands covers in GT enclosures, back plates in XN.. enclosures

DIN mounting rail TH-S

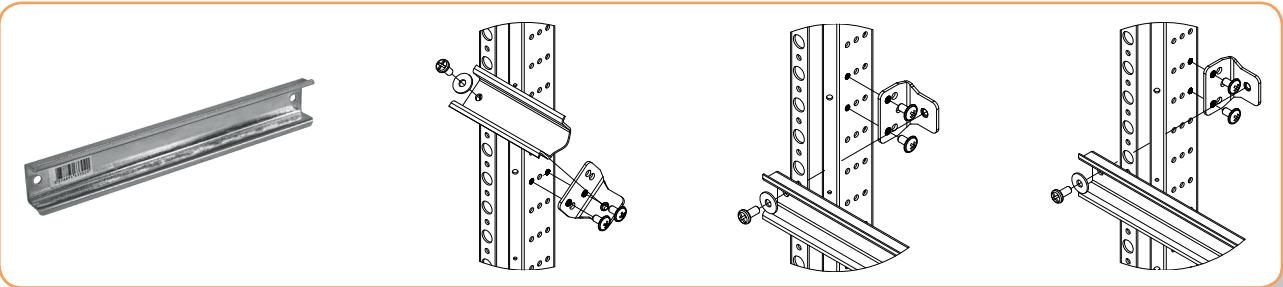

Rail TH-S can be mounted with different distances to the covers (for the LG-V : minimum distance rails to cover is 42.5 mm, the basic distance 48.5 mm, the maximum 64.5 mm; for the LG-V5 minimal distance is 70 mm, the basic 76 mm and maximum 92 mm).

Rails TH-S can also be mounted at an angle approx. 51 degrees to the vertical plain. This facilitates an approach to connect wires to the terminals mounted on the DIN rail.

CP covers

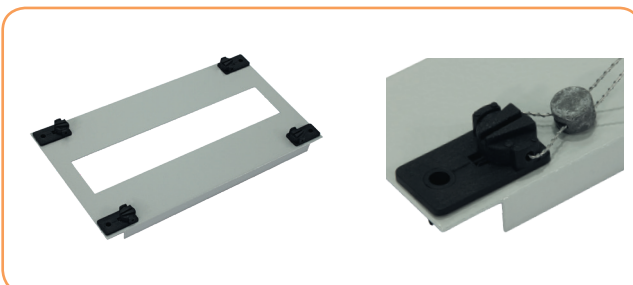

CP covers are made of powder-coated sheet steel. All covers are equipped with earthing pins (if any equipment is mounted on the covers or insulating gaps are less than shown in EN 61439-1 standard a cover grounding is recommended). CP covers are equipped with clips fastening in commercial set. Clips have the possibility of sealing. The special design of the clips allows easy and fast cover installation.

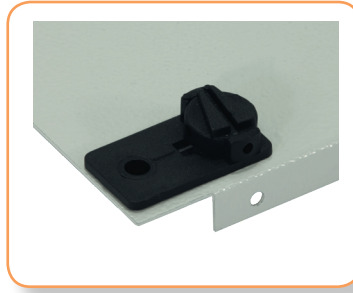
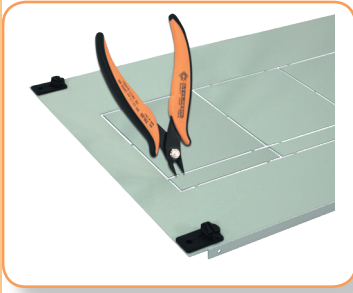

The offer includes plain covers, covers matching to 45 mm modular equipment, covers dedicated for MCCB's EB/ED, disconnectors with fuses LTL/HVL, switch disconnectors type LA and combined with an additional 45mm holes for modular equipment. Covers have a weakening to be cut to allow adaptation to the different sizes of units and configurations (different mounting depth, right and left). Covers dedicated to EB/ED, LTL/HVL, LA has to be assembled in a certain position. For easy recognition mounting position small hole is always located in the left bottom corner. Cut-outs in covers allow matching cover to the device (type, mounting place). For cut out elements from cover use the CP-PLIER pliers. Dedicated CP covers and appropriate PM mounting plates are available. Method of attachment devices, covers and mounting plates to the brackets is included in the respective mounting instructions supplied with CP covers.

Instructions are also available on the website.

Mounting plates PM

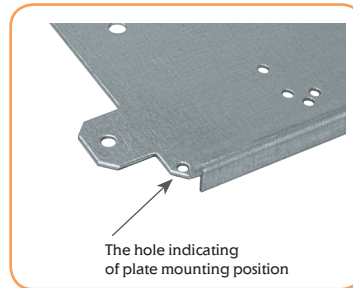
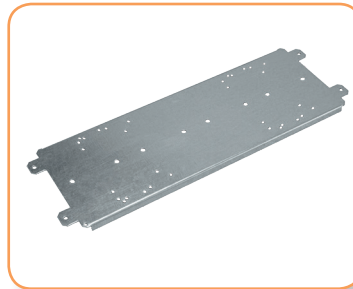

Mounting plates are made of galvanized sheet steel 1.5 mm to 3 mm. Thick plates have drilled holes for mounting ETI devices. The plates for disconnectors and circuit breakers EB / ED, LTL / HVL and modular equipment are equipped with mounting rail (height TH15 mm). Mounting plates as well as the covers have positioning holes always located in the left bottom corner. To improve stiffness of the plates edges are folded. For fixing electric apparatus to the mounting plate appropriate screws, nuts and washers should be purchased. Circuit breakers EB and disconnectors ED have included M4 screws (2 pcs version 3 service, 4 pieces 4 half) without nuts and washers securing. Mounting plates for WP-A brackets are fixed with 4 pieces of LG-V or LG-V5 elements. Method of attachment devices, covers and mounting plates to the vertical brackets is included in the respective assembly instructions supplied with CP covers.

Instructions are also available on the website.

SYSTEM ELEMENTS GSX
SOLID GSX
Plain covers (without cut-outs) - Height 50 mm

Type	Product name	Code no.	Weight (kg)	Packaging (pc.)
CP 1-0.33 F	Plain cover (250x50)	001101420	0,11	1
CP 1.4-0.33 F	Plain cover (350x50)	001101421	0,14	1
CP 2.2-0.33 F	Plain cover (550x50)	001101422	0,23	1
CP 3-0.33 F	Plain cover (750x50)	001101423	0,31	1
CP 3.8-0.33 F	Plain cover (950x50)	001101424	0,39	1

Mounting instructions: CP X-Y F

Plain covers (without cut-outs) - Height 75 mm

Type	Product name	Code no.	Weight (kg)	Packaging (pc.)
CP 1-0.5 F	Plain cover (250x75)	001101425	0,15	1
CP 2-0.5 F	Plain cover (500x75)	001101426	0,30	1
CP 3-0.5 F	Plain cover (750x75)	001101427	0,45	1

Mounting instructions: CP X-Y F

Plain covers (without cut-outs) - Height 150 mm

Type	Product name	Code no.	Weight (kg)	Packaging (pc.)
CP 1-1 F	Plain cover (250x150)	001101429	0,28	1
CP 1.4-1 F	Plain cover (350x150)	001101430	0,39	1
CP 2-1 F	Plain cover (500x150)	001101431	0,55	1
CP 2.2-1 F	Plain cover (550x150)	001101432	0,61	1
CP 3-1 F	Plain cover (750x150)	001101433	0,83	1
CP 3.8-1 F	Plain cover (950x150)	001101434	1,05	1

Mounting instructions: CP X-Y F

Plain covers (without cut-outs) - Height 300 mm

Type	Product name	Code no.	Weight (kg)	Packaging (pc.)
CP 1-2 F	Plain cover (250x300)	001101436	0,52	1
CP 1.4-2 F	Plain cover (350x300)	001101437	0,73	1
CP 2-2 F	Plain cover (500x300)	001101438	1,05	1
CP 2.2-2 F	Plain cover (550x300)	001101439	1,15	1
CP 3-2 F	Plain cover (750x300)	001101440	1,57	1
CP 3.8-2 F	Plain cover (950x300)	001101441	1,99	1

Mounting instructions: CP X-Y F

Plain covers (without cut-outs) - Height 450 mm

Type	Product name	Code no.	Weight (kg)	Packaging (pc.)
CP 1-3 F	Plain cover (250x450)	001101443	0,77	1
CP 2-3 F	Plain cover (500x450)	001101444	1,55	1
CP 3-3 F	Plain cover (750x450)	001101445	2,32	1

Mounting instructions: CP X-Y F

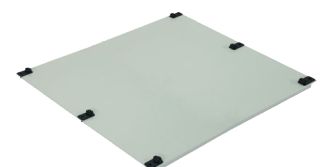
Covers

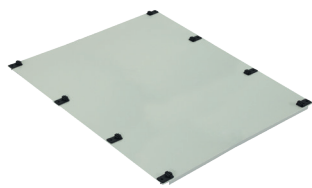

Plain covers (without cut-outs) - Height 600 mm

Type	Product name	Code no.	Weight (kg)	Packaging (pc.)
CP 1-4 F	Plain cover (250x600)	001101447	1,02	1
CP 2-4 F	Plain cover (500x600)	001101448	2,04	1
CP 3-4 F	Plain cover (750x600)	001101449	3,06	1

Mounting instructions: CP X-Y F



Modular covers 150 mm

Type	Product name	Code no.	Weight (kg)	Packaging (pc.)
CP 1-1 M	Modular cover 12 mod. (250x150)	001101451	0,21	1
CP 1.4-1 M	Modular cover 17 mod. (350x150)	001101452	0,29	1
CP 2-1 M	Modular cover 24 mod. (500x150)	001101453	0,42	1
CP 2.2-1 M	Modular cover 26 mod. (550x150)	001101454	0,46	1
CP 3-1 M	Modular cover 36 mod. (750x150)	001101455	0,63	1
CP 3.8-1 M	Modular cover 46 mod. (950x150)	001101456	0,79	1

Mounting instructions: CP X-1 M



Modular covers - Height 225 mm

Type	Product name	Code no.	Weight (kg)	Packaging (pc.)
CP 1-1.5 M	Modular cover 12 mod. (250x225)	001101458	0,33	1
CP 2-1.5 M	Modular cover 24 mod. (500x225)	001101459	0,67	1
CP 3-1.5 M	Modular cover 36 mod. (750x225)	001101460	1,00	1

Mounting instructions: CP X-1.5 M

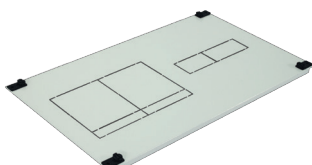

Covers for disconnectors HVL00/LTL00 and modular equipment - Height 300 mm

Type	Product name	Code no.	Weight (kg)	Packaging (pc.)
CP 1-2 H00 M	Cover 1xHVL00/LTL00 and 4 mod. (250x300)	001101474	0,52	1
CP 1.4-2 H00 M	Cover 1xHVL00/LTL00 and 5 mod. (350x300)	001101475	0,72	1
CP 2-2 H00 M	Cover 2xHVL00/LTL00 and 9 mod. (500x300)	001101476	1,03	1
CP 2.2-2 H00 M	Cover 2xHVL00/LTL00 and 10 mod. (550x300)	001101477	1,14	1
CP 3-2 H00 M	Cover 3xHVL00/LTL00 and 16 mod. (750x300)	001101478	1,55	1
CP 3.8-2 H00 M	Cover 4xHVL00/LTL00 and 21 mod. (950x300)	001101479	1,96	1

Cover must be completed with correspondent dedicated mounting plate: PM...H00 M

Mounting instructions: CP X-2 H00 M

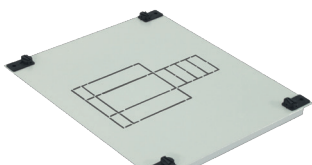

Covers for circuit breakers/disconnectors EB2/ED2 125,160,250 3P and modular equipment - Height 300 mm

Type	Product name	Code no.	Weight (kg)	Packaging (pc.)
CP 1-2 E12 M 3P	Cover 1xEB2/ED2 125,160,250A 3P and 4 mod. (250x300)	001101481	0,51	1

Cover must be completed with correspondent dedicated mounting plate: PM 1 E12 M 3P

Mounting instructions: CP 1-2 E12 M 3P

Covers for circuit breakers/disconnectors EB2/ED2 125,160,250 3,4P and modular equipment – Height 300 mm

Type	Product name	Code no.	Weight (kg)	Packaging (pc.)
CP 1.4-2 E12 M	Cover 1xEB2/ED2 125,160,250A 3,4P and 4 mod. (350x300)	001101482	0,72	1
CP 2-2 E12 M	Cover 1xEB2/ED2 125,160,250A 3,4P and 12 mod. (500x300)	001101483	1,03	1
CP 2.2-2 E12 M	Cover 1xEB2/ED2 125,160,250A 3,4P and 14 mod. (550x300)	001101484	1,13	1
CP 3-2 E12 M	Cover 1xEB2/ED2 125,160,250A 3,4P and 25 mod. (750x300)	001101485	1,54	1
CP 3.8-2 E12 M	Cover 1xEB2/ED2 125,160,250A 3,4P and 36 mod. (950x300)	001101486	1,95	1

Cover must be completed with correspondent dedicated mounting plate: PM... E12 M
 Mounting instruction: CP X-2 E12 M

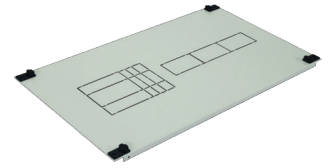

Covers for disconnectors HVL00/LTL00 – Height 300 mm

Type	Product name	Code no.	Weight (kg)	Packaging (pc.)
CP 1-2 H00	Cover 1xHVL00/LTL00 (250x300)	001101488	0,52	1
CP 1.4-2 H00	Cover 2xHVL00/LTL00 (350x300)	001101489	0,72	1
CP 2-2 H00	Cover 4xHVL00/LTL00 (500x300)	001101490	1,03	1
CP 2.2-2 H00	Cover 4xHVL00/LTL00 (550x300)	001101491	1,13	1
CP 3-2 H00	Cover 6xHVL00/LTL00 (750x300)	001101492	1,55	1
CP 3.8-2 H00	Cover 8xHVL00/LTL00 (950x300)	001101493	1,96	1

Cover must be completed with correspondent dedicated mounting plate: PM... H00
 Mounting instruction: CP X-2 H00

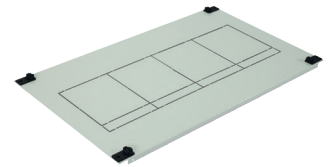

Covers for circuit breakers /disconnectors EB2/ED2 125,160,250 3,4P – Height 300 mm

Type	Product name	Code no.	Weight (kg)	Packaging (pc.)
CP 1-2 E12	Cover 1xEB2/ED2 125,160,250A 3,4P (250x300)	001101514	0,51	1
CP 1.4-2 E12	Cover 1xEB2/ED2 125,160,250A 3,4P (350x300)	001101515	0,72	1
CP 2-2 E12	Cover 2xEB2/ED2 125,160,250A 3,4P (500x300)	001101516	1,02	1
CP 2.2-2 E12	Cover 2xEB2/ED2 125,160,250A 3,4P (550x300)	001101517	1,13	1
CP 3-2 E12	Cover 3xEB2/ED2 125,160,250A 3,4P (750x300)	001101518	1,53	1
CP 3.8-2 E12	Cover 3xEB2/ED2 125,160,250A 3,4P (950x300)	001101519	1,95	1

Cover must be completed with correspondent dedicated mounting plate: PM... E12 L12
 Mounting instruction: CP X-2 E12

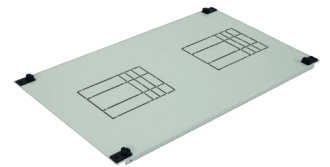

Covers for LBS 160 A and modular devices

Type	Product name	Code No.	Weight (kg)	Packaging (pcs.)
CP 1.4-2 S1 M	Cover 1xLBS160A and 4 mod. devices	001101720	0,72	1
CP 2-2 S1 M	Cover 1xLBS160A and 12 mod. devices	001101721	1,03	1
CP 2.2-2 S1 M	Cover 1xLBS160A and 14 mod. devices	001101722	1,13	1
CP 3-2 S1 M	Cover 1xLBS160A and 25 mod. devices	001101723	1,55	1

Covers must be used with dedicated mounting plates: PM... E12 M and to each mounting plate are needed 2 pcs. of LG-V SET (code no. 001101683) - details in instruction

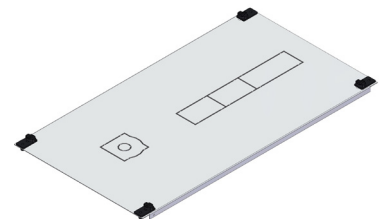

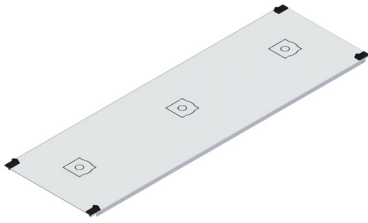

Covers for LBS 250 A

Type	Product name	Code No.	Weight (kg)	Packaging (pcs.)
CP 1-2 S2	Cover 1xLBS250A	001101731	0,51	1
CP 1.4-2 S2	Cover 1xLBS250A	001101732	0,73	1
CP 2-2 S2	Cover 2xLBS250A	001101733	1,04	1
CP 2.2-2 S2	Cover 2xLBS250A	001101734	1,14	1
CP 3-2 S2	Cover 3xLBS250A	001101735	1,56	1

Covers must be used with dedicated mounting plates: PM...E12 L12 and to each mounting plate are needed 2 pcs. of LG-V5 SET (code no. 001101685) - details in instruction



Covers for disconnectors LA1 – Height 300 mm

Type	Product name	Code no.	Weight (kg)	Packaging (pc.)
CP 1-2 L1	Cover 1xLA1 (250x300)	001101527	0,52	1
CP 1.4-2 L1	Cover 1xLA1 (350x300)	001101528	0,73	1
CP 2-2 L1	Cover 2xLA1 (500x300)	001101529	1,04	1
CP 2.2-2 L1	Cover 2xLA1 (550x300)	001101530	1,14	1
CP 3-2 L1	Cover 3xLA1 (750x300)	001101531	1,56	1
CP 3.8-2 L1	Cover 3xLA1 (950x300)	001101532	1,98	1

Cover must be completed with correspondent dedicated mounting plate: PM...E12 L12
Mounting instruction: CP X-2 L1

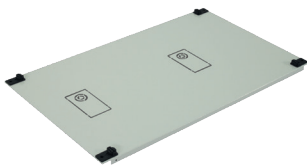

Covers for disconnectors LA2– Height 300 mm

Type	Product name	Code no.	Weight (kg)	Packaging (pc.)
CP 1-2 L2	Cover 1xLA2 (250x300)	001101534	0,52	1
CP 1.4-2 L2	Cover 1xLA2 (350x300)	001101535	0,73	1
CP 2-2 L2	Cover 2xLA2 (500x300)	001101536	1,04	1
CP 2.2-2 L2	Cover 2xLA2 (550x300)	001101537	1,14	1
CP 3-2 L2	Cover 3xLA2 (750x300)	001101538	1,56	1
CP 3.8-2 L2	Cover 3xLA2 (950x300)	001101539	1,98	1

Cover must be completed with correspondent dedicated mounting plate: PM...E12 L12
Mounting instructions: CP X-2 L2

Mounting plates and DIN rails TH-S

To fix the mounting plate PM ... H00 M, PM ... E12 M, PM ... H00, L12 E12 PM ..., PM ... PER-A to the vertical bracket WP-A it is necessary to buy 2 mounting sets LG-V SET- code number 001101683 or purchase separately individual elements according to the statement in the following table:

Type	Product name	Quantity (pcs.)
LG-V	Fixing element with a nut M5	4
AST 4.8x9.5	Sheet metal screw Philips head PH2	8
AW-RE 5	Plain washer (extended)	4
AS-C 5x10	Metric screw Philips head PH2	4

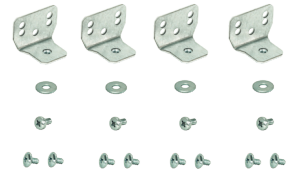

To fix the mounting rail TH-S to the vertical bracket WP-A it is necessary to buy 1 mounting set LG-V SET- code number 001101683 or purchase separately individual elements according to the statement in the following table. To fix the mounting rail TH-S to the vertical support WP-U use 2 pcs. sheets metal screw AST 4.8x9.5

Type	Product name	Quantity (pcs.)
LG-V	Fixing element with a nut M5	2
AST 4.8x9.5	Sheet steel metal screw Philips head PH2	4
AW-RE 5	Plain washer (extended)	2
AS-C 5x10	Metric screw Philips head PH2	2



Mounting plates for disconnectors HVL00/LTL00 and modular equipment

Type	Product name	Code no.	Weight (kg)	Packaging (pc.)
PM 1 H00 M	Mounting plate 1xHVL00/LTL00 with DIN rail for 4 mod. (250)	001101563	0,31	1
PM 1.4 H00 M	Mounting plate 1xHVL00/LTL00 with DIN rail for 5 mod. (350)	001101564	0,53	1
PM 2 H00 M	Mounting plate 2xHVL00/LTL00 with DIN rail for 9 mod. (500)	001101565	0,79	1
PM 2.2 H00 M	Mounting plate 2xHVL00/LTL00 with DIN rail for 10 mod. (550)	001101566	0,88	1
PM 3 H00 M	Mounting plate 3xHVL00/LTL00 with DIN rail for 16 mod. (750)	001101567	1,31	1
PM 3.8 H00 M	Mounting plate 4xHVL00/LTL00 with DIN rail for 21 mod. (950)	001101568	1,57	1

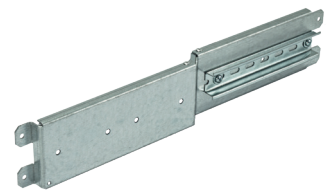

To fix on the mounting plate one piece of disconnector HVL00/LTL00 should be purchased:

- screw M6x16 DIN 933 (AS-H 6x16) - 2 pcs.
- plain washer M6 DIN126 (AW-R 6) - 4 pcs.
- spring washer M6 DIN127 (AW-S 6) -2 pcs.
- nut M6 DIN934 (AN-H 6) - 2 pcs.

Mounting instruction : CP X-2 H00 M

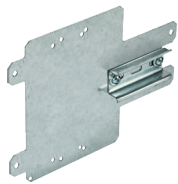

Mounting plate for circuit breakers/disconnectors EB2/ED2 125,160,250 3P and modular equipment

Type	Product name	Code no.	Weight (kg)	Packaging (pc.)
PM 1 E12 M 3P	Mounting plate 1xEB2/ED2 3P with DIN rail for 4 mod. (250)	001101570	0,43	1

For fixing on the mounting plate one piece circuit breaker/disconnector EB2/ED2 with 3P version, should be purchased:

- plain washer M4 DIN126 (AW-R 4) - 2 pcs.
- spring washer M4 DIN127 (AW-S 4)-2 pcs.
- nut M4 DIN934 (AN-H 4) - 2 pcs.

Fixing screws in set with devices.

Mounting instruction: CP 1-2 E12 M 3P

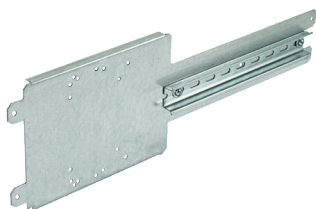

Mounting plate for circuit breakers/disconnectors EB2/ED2 125,160,250 3P, 4P; LBS 160 and modular equipment

Type	Product name	Code no.	Weight (kg)	Packaging (pc.)
PM 1.4 E12 M	Mounting plate 1xEB2/ED2 with DIN rail for 4 mod. (350)	001101571	0,68	1
PM 2 E12 M	Mounting plate 1xEB2/ED2 with DIN rail for 12 mod. (500)	001101572	0,94	1
PM 2.2 E12 M	Mounting plate 1xEB2/ED2 with DIN rail for 14 mod. (550)	001101573	1,03	1
PM 3 E12 M	Mounting plate 1xEB2/ED2 with DIN rail for 25 mod. (750)	001101574	1,36	1
PM 3.8 E12 M	Mounting plate 1xEB2/ED2 with DIN rail for 36 mod. (950)	001101575	1,70	1

For fixing on the plate one piece circuit breaker/disconnector EB2/ED2 should be purchased:
version 3P

- plain washer M4 DIN126 (AW-R 4) - 2 pcs.
- spring washer M4 DIN127 (AW-S 4) - 2 pcs.
- nut M4 DIN934 (AN-H 4) - 2 pcs.

version 4P

- plain washer M4 DIN126 (AW-R 4) - 4 pcs.
- spring washer M4 DIN127 (AW-S 4) - 4 pcs.
- nut M4 DIN934 (AN-H 4) - 4 pcs.

Mounting instruction: CP X-2 E12 M



Mounting plates for disconnectors HVL00/LTL00

Type	Product name	Code no.	Weight (kg)	Packaging (pc.)
PM 1 H00	Mounting plate 1xHVL00/LTL00 (250)	001101577	0,32	1
PM 1.4 H00	Mounting plate 2xHVL00/LTL00 (350)	001101578	0,46	1
PM 2 H00	Mounting plate 4xHVL00/LTL00 (500)	001101579	0,70	1
PM 2.2 H00	Mounting plate 4xHVL00/LTL00 (550)	001101580	0,78	1
PM 3 H00	Mounting plate 6xHVL00/LTL00 (750)	001101581	1,08	1
PM 3.8 H00	Mounting plate 8xHVL00/LTL00 (950)	001101582	1,39	1

For fixing on the plate one piece of disconnector HVL00/LTL00 should be purchased:

- screw M6x16 DIN 933 (AS-H 6x16) - 2 pcs.
- plain washer M6 DIN126 (AW-R 6) - 4 pcs.
- spring washer M6 DIN127 (AW-S 6)-2pcs.
- nut M6 DIN934 (AN-H 6) - 2 pcs.

Mounting instruction: CP X-2 H00

Mounting plate for circuit breakers/disconnectors EB2/ED2 125,160,250 3, 4P; LBS 160, LA1, LA2

Type	Product name	Code no.	Weight (kg)	Packaging (pc.)
PM 1 E12 L12	Mounting plate 1xEB2/ED2 125,160,250A 3,4P or 1xLA1,2 (250)	001101584	0,490	1
PM 1.4 E12 L12	Mounting plate 1xEB2/ED2 125,160,250A 3,4P or 1xLA1,2 (350)	001101585	0,757	1
PM 2 E12 L12	Mounting plate 2xEB2/ED2 125,160,250A 3,4P or 2xLA1,2 (500)	001101586	1,153	1
PM 2.2 E12 L12	Mounting plate 2xEB2/ED2 125,160,250A 3,4P or 2xLA1,2 (550)	001101587	1,287	1
PM 3 E12 L12	Mounting plate 3xEB2/ED2 125,160,250A 3,4P or 3xLA1,2 (750)	001101588	1,818	1
PM 3.8 E12 L12	Mounting plate 3xEB2/ED2 125,160,250A 3,4P or 3xLA1,2 (950)	001101589	2,352	1

For fixing on the plate one piece circuit breaker/disconnector EB2/ED2 should be purchased :
version 3P

- plain washer M4 DIN126 (AW-R 4) - 2 pcs.
- spring washer M4 DIN127 (AW-S 4) - 2 pcs.
- nut M4 DIN934 (AN-H 4) W - 2 pcs.

version 4P

- plain washer M4 DIN126 (AW-R 4) - 4 pcs.
- spring washer M4 DIN127 (AW-S 4) - 4 pcs.
- nut M4 DIN934 (AN-H 4) - 4 pcs.

Fixing screws in set with devices..

Mounting instruction: CP X-2 E12

For attaching one piece LA1 should be purchased:

- screw M4x16 DIN7985 (AS-C 4x16) - 4 pcs.
- plain washer M4 DIN126 (AW-R 4) - 4 pcs.
- spring washer M4 DIN127 (AW-S 4) - 8 pcs.
- nut M4 DIN934 (AN-H 4) - 4 pcs.

Mounting instruction: CP X-2 L1

For fixing one piece LA2 should be purchased:

- screw M4x20 DIN7985 (AS-C 4x20) - 4 pcs.
- plain washer M4 DIN126 (AW-R 4) - 4 pcs.
- spring washer M4 DIN127 (AW-S 4) - 8 pcs.
- nut M4 DIN934 (AN-H 4) - 8 pcs.

Mounting instruction: CP X-2 L2

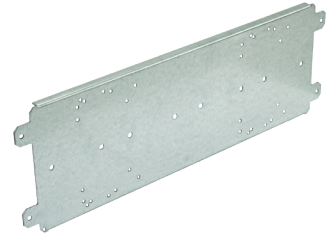
Perforated mounting plates

Type	Product name	Code no.	Weight (kg)	Packaging (pc.)
PM 1-1 PER-A	Perforated mounting plate Type A (250)	001101620	0,17	1
PM 1-2 PER-A	Perforated mounting plate Type A (250)	001101621	0,48	1
PM 1-3 PER-A	Perforated mounting plate Type A (250)	001101622	0,76	1
PM 1-4 PER-A	Perforated mounting plate Type A (250)	001101623	1,04	1
PM 2-1 PER-A	Perforated mounting plate Type A (500)	001101624	0,38	1
PM 2-2 PER-A	Perforated mounting plate Type A (500)	001101625	0,97	1
PM 2-3 PER-A	Perforated mounting plate Type A (500)	001101626	1,51	1
PM 2-4 PER-A	Perforated mounting plate Type A (500)	001101627	2,05	1
PM 3-1 PER-A	Perforated mounting plate Type A (750)	001101628	0,57	1
PM 3-2 PER-A	Perforated mounting plate Type A (750)	001101629	1,48	1
PM 3-3 PER-A	Perforated mounting plate Type A (750)	001101630	2,29	1
PM 3-4 PER-A	Perforated mounting plate Type A (750)	001101631	3,10	1

Perforation - square holes 9,5 mm x 9,5 mm

Mounting instruction: PM X-Y PER-A

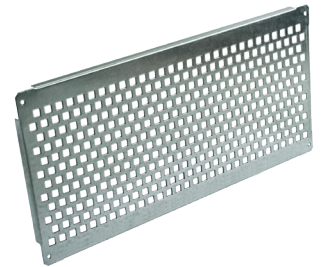
Mounting DIN rails TH-S

Type	Product name	Code no.	Weight (kg)	Packaging (pc.)
TH-S 1	Mounting rail 35/15 1.5 steel 215mm (250)	002911040	0,15	1
TH-S 1.4	Mounting rail 35/15 1.5 steel 315mm (350)	002911041	0,21	1
TH-S 2	Mounting rail 35/15 1.5 steel 465mm (500)	002911042	0,32	1
TH-S 2.2	Mounting rail 35/15 1.5 steel 515mm (550)	002911043	0,35	1
TH-S 3	Mounting rail 35/15 1.5 steel 715mm (750)	002911044	0,49	1
TH-S 3.8	Mounting rail 35/15 1.5 steel 915mm (950)	002911045	0,62	1

Selection the length of the rail depends on the mounting insert (removable or fixed) width.



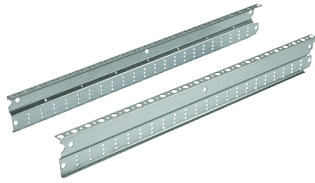

Vertical brackets WP-A

Type	Product name	Code no.	Weight (kg)	Packaging (pc.)
WP-A 2.33	3 position vertical bracket Type A (350) (1set=left and right)	001101716	0,68	1
WP-A 3	3 position vertical bracket Type A (450) (1set=left and right)	001101644	0,89	1
WP-A 3.66	3 position vertical bracket Type A (550) (1set=left and right)	001101645	1,09	1
WP-A 4	3 position vertical bracket Type A (600) (1set=left and right)	001101646	1,2	1
WP-A 5	3 position vertical bracket Type A (750) (1set=left and right)	001101647	1,51	1
WP-A 6	3 position vertical bracket Type A (900) (1set=left and right)	001101648	1,82	1
WP-A 6.33	3 position vertical bracket Type A (950) (1set=left and right)	001101649	1,92	1
WP-A 7	3 position vertical bracket Type A (1050) (1set=left and right)	001101650	2,13	1
WP-A 7.66	3 position vertical bracket Type A (1150) (1set=left and right)	001101651	2,34	1

Mounting instruction: WP-A
 Selection of vertical bracket depends on the height of the enclosure.



Vertical brackets WP-U

Type	Product name	Code no.	Weight (kg)	Packaging (pc.)
WP-U 2.33	1 position vertical bracket Type U (350) (1set = 2pcs.)	001101717	0,81	1
WP-U 3	1 position vertical bracket Type U (450) (1set = 2pcs.)	001101666	1,06	1
WP-U 3.66	1 position vertical bracket Type U (550) (1set = 2pcs.)	001101667	1,30	1
WP-U 4	1 position vertical bracket Type U (600) (1set = 2pcs.)	001101668	1,42	1
WP-U 5	1 position vertical bracket Type U (750) (1set = 2pcs.)	001101669	1,78	1
WP-U 6	1 position vertical bracket Type U (900) (1set = 2pcs.)	001101670	2,15	1
WP-U 6.33	1 position vertical bracket Type U (950) (1set = 2pcs.)	001101671	2,27	1
WP-U 7	1 position vertical bracket Type U (1050) (1set = 2pcs.)	001101672	2,51	1
WP-U 7.66	1 position vertical bracket Type U (1150) (1set = 2pcs.)	001101673	2,75	1

Mounting instruction: WP-U
 Selection of vertical bracket depends on the height of the enclosure.

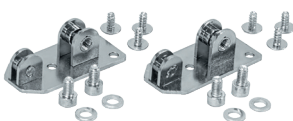

Dividing element EPW (set)

Type	Product name	Code no.	Weight (kg)	Packaging (pc.)
EPW	Enclosure dividing element (1set=2pcs.)	001101677	0,11	1

Mounting instruction: EPW

Fixing element with a nut M5

Type	Product name	Code no.	Weight (kg)	Packaging (pc.)
LG-V	Fixing element with a nut M5	001101679	0,03	50

**Fixing element with a nut M5 type V5**

Type	Product name	Code no.	Weight (kg)	Packaging (pc.)
LG-V5	Fixing element with a nut M5 type V5	001101681	0,04	20

**Fixing set with a nut M5 (1set=2pcs.)**

Type	Product name	Code no.	Weight (kg)	Packaging (pc.)
LG-V SET	Fixing set with a nut M5 (1kpl.=2szt.)	001101683	0,07	1

Mounting instruction: LG-V SET

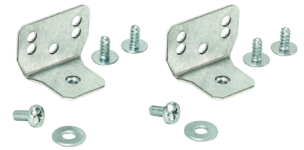
**Fixing set with a nut M5 type V5 (1set=2pcs.)**

Type	Product name	Code no.	Weight (kg)	Packaging (pc.)
LG-V5 SET	Fixing set with a nut M5 type V5 (1set=2pcs.)	001101685	0,09	1

Mounting instruction: LG-V5 SET

Note: Code numbers of screws, nuts and washers concern sets no single elements. Price in price list is for 1 set.

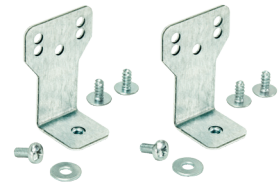
**Sheet metal cross head screw PH2**

Type	Product name	Code no.	Weight (kg)	Packaging (pc.)
AST 4.8x9.5 SET	Sheet steel metal screw cross head PH2 (1set=200pcs.)	001101686	0,4	1

**Metric screw - cross head PH2 DIN7985**

Type	Product name	Code no.	Weight (kg)	Packaging (pc.)
AS-C 4x16 SET	Metric screw - cross head PH2 DIN7985 (1set=10pcs.)	001101687	0,02	1
AS-C 4x20 SET	Metric screw - cross head PH2 DIN7985 (1set=10pcs.)	001101688	0,03	1

**Metric screw - cross head PH2 DIN7985**

Type	Product name	Code no.	Weight (kg)	Packaging (pc.)
AS-C 5x10 SET	Metric screw - cross head PH2 DIN7985 (1set=100pcs.)	001101689	0,30	1

**Metric screw M6-hex socked head DIN933**

Type	Product name	Code no.	Weight (kg)	Packaging (pc.)
AS-H 6x16 SET	Metric screw M6-hex socked head DIN933 (1set=10pcs.)	001101690	0,65	1

**Extended washer DIN9021**

Type	Product name	Code no.	Weight (kg)	Packaging (pc.)
AW-RE 5 SET	Washer d=5,3 D=15 extended DIN9021 (1set=100pcs.)	001101692	0,15	1



Round plain washers DIN126

Type	Product name	Code no.	Weight (kg)	Packaging (pc.)
AW-R 4 SET	Round plain washers DIN126 d=4,3 D=10 DIN126 (1set=10pcs.)	001101693	0,01	1
AW-R 6 SET	Round plain washers d=6,6 D=12 DIN126 (1set=10pcs.)	001101694	0,01	1

Spring washers DIN127

Type	Product name	Code no.	Weight (kg)	Packaging (pc.)
AW-S 4 SET	Spring washer d=4,1 D=6,88 DIN127 (1set=10pcs.)	001101696	0,01	1
AW-S 6 SET	Spring washer d=6,1 D=9,78 DIN127 (1set=10pcs.)	001101698	0,01	1

Nuts DIN934

Type	Product name	Code no.	Weight (kg)	Packaging (pc.)
AN-H 4 SET	Nuts M4 DIN934 (1set=10pcs.)	001101700	0,01	1
AN-H 6 SET	Nuts M6 DIN934 (1set=10pcs.)	001101702	0,02	1

Holders for mounting plate for GT enclosures

Type	Product name	Code no.	Weight (kg)	Packaging (pc.)
UW-GT 150	Holders for mounting plate GT depth 150mm (1kpl.=4szt.)	001101705	0,49	1
UW-GT 200	Holders for mounting plate GT depth 200mm (1kpl.=4szt.)	001101706	0,58	1
UW-GT 250	Holders for mounting plate GT depth 250mm (1kpl.=4szt.)	001101707	0,67	1
UW-GT 300	Holders for mounting plate GT depth 300mm (1kpl.=4szt.)	001101708	0,82	1
UW-GT 400	Holders for mounting plate GT depth 400mm (1kpl.=4szt.)	001101709	1,05	1

1 set contains: 4 x holders + 6 x plain washers + 8 x hex socketed screws M6x10 + 2 x screws M5x10 + 2 x nuts M5

Mounting instruction: UW-GT

Selection of holder depending on the depth of the GT enclosure

Cable flanges with pins

Type	Product name	Code no.	Weight (kg)	Packaging (pc.)
EH-TKC-36	Cable flanges with pins (1set)	001101711	0,19	1

1 set contains: 1 x cable flange + 4 x pin

Mounting instruction: EH-TKC-36

Steel cable gland

Type	Product name	Code no.	Weight (kg)	Packaging (pc.)
EH-ST	Steel cable gland	001101712	0,24	1

1 set contains: 1 x steel cable gland + 4 x nut M8

Mounting instruction: EH

Aluminium cable gland

Type	Product name	Code no.	Weight (kg)	Packaging (pc.)
EH-AL	Aluminium cable gland	001101713	0,16	1

1 set contains: 1 x Aluminium cable gland + 4 x nut M8

Mounting instruction: EH

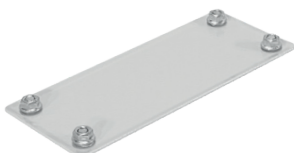
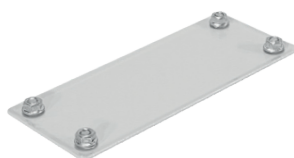
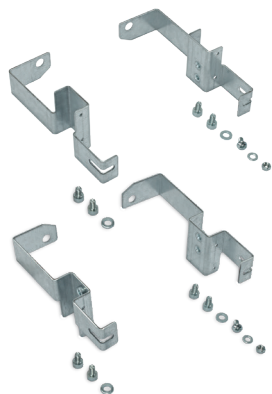

Key Lock

Type	Product name	Code no.	Weight (kg)	Packaging (pc.)
LK-1333-M22 RAL 7035	Key Lock	001101718	0,15	1

Handle for enclosure hanging

Type	Product name	Code no.	Weight (kg)	Packaging (pc.)
UCH-2	Handle for enclosure hanging (1set=2pcs.)	001101715	0,06	1

1 set contains: 2 x handle + 2 x nut M8
Mounting instruction: UCH-2

Seal

Type	Product name	Code no.	Weight (kg)	Packaging (pc.)
SEAL-G9	Adhesive seal -10 meters (1set=10m)	001101608	0,09	1

Modular cover

Type	Product name	Code no.	Weight (kg)	Packaging (pc.)
MP-ECH	Modular cover	001101053	0,026	10/500

Paint repair RAL7035

Type	Product name	Code no.	Weight (kg)	Packaging (pc.)
FA-RAL7035	Paint repair RAL7035 (200 ml)	001101710	0,23	1

Pliers for cut-out in CP covers

Type	Product name	Code no.	Weight (kg)	Packaging (pc.)
CP-PLIER	Pliers for CP covers	001101714	0,07	1



ETIBOX

Examples of the enclosure configuration with mounting inserts

Example 1. 4XP160 2-4 enclosure with insert ready to install modular equipment.

Flush-mounted 4XP160 enclosure with IP42 degree of protection (it is possible to increase to IP44 by correct sealing SEAL-G9) with a width of 610 mm, 710 mm, 160 mm depth. Enclosure suitable for mounting modular devices with total 96 moduls. The applied support WP-U is an economical without possibility to TH-S at depth change, and without the ability to divide cabinet vertically. Please note that the sheet metal screw fixing rails needed for TH-S and mounting plates PM are sold in 200 units set. There are 8 pieces of sheet metal screws needed.

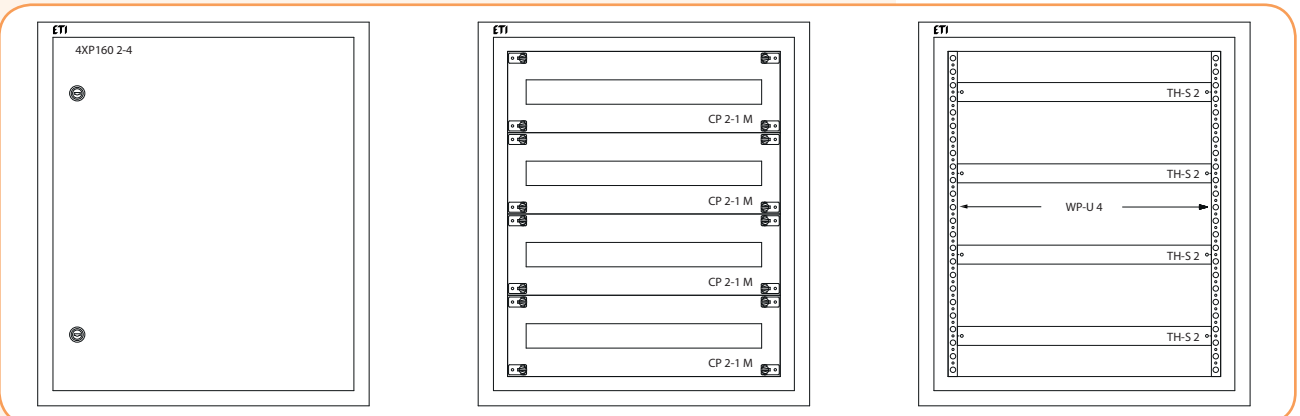

List of materials for 4XP160 2-4 enclosure with spare cost insert for modular equipment

No.	Type	Product name	Code no.	Quantity to be ordered
1	4XP160 2-4	Flush-mounted enclosure, IP42, kl. and RAL7035 (610x710x160)	001101411	1
2	WP-U 4	1 position vertical bracket Type U (600) (1set=2pcs.)	001101668	1
3	CP 2-1 M	Modular cover 24 mod. (500x150)	001101453	4
4	TH-S 2	Mounting rail 35/15 1.5 steel 465mm (500)	002911042	4
5	AST 4.8x9.5 SET	Sheet steel metal screw cross head PH2 (1set=200pcs.)	001101686	1

Example 2. Wall-mounted enclosure 4XN160 2-6 with insert ready to install modular equipment.

Wall-mounted enclosure 4XN160 with IP41 degree of protection (it is possible to increase the degree of protection to IP44 by correct sealing SEAL-G9) with a width of 550 mm, 950 mm, 160 mm depth. An enclosure suitable for mounting modular devices with total 144 moduls. The use of vertical bracket WP-A allows to adjust to the depth of rails.

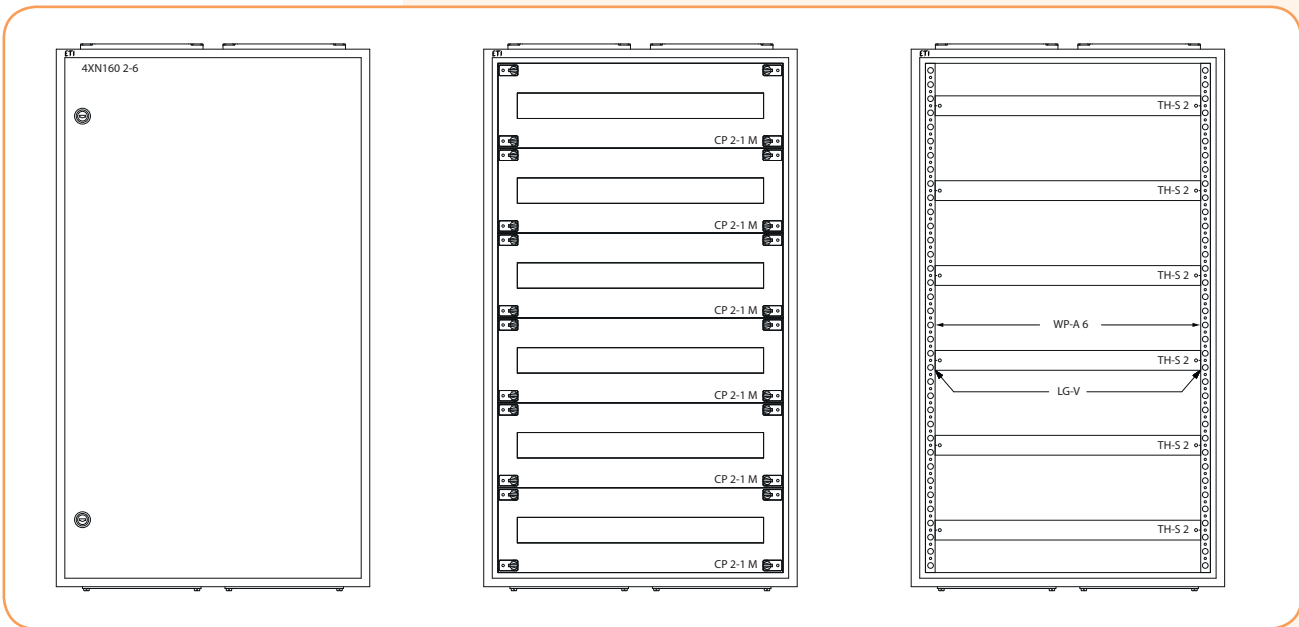

List of materials for 4XP160 2-6 enclosure with insert and modular equipment

No.	Type	Product name	Code no.	Quantity to be ordered
1	4XN160 2-6	Wall-mounted enclosure - empty, IP41, kl. and RAL7035 (550x950x160)	001101403	1
2	WP-A 6	3 position vertical Type A (900) (1set=left and right)	001101648	1
3	CP 2-1 M	Modular cover 24 mod. (500x150)	001101453	6
4	TH-S 2	Mounting rail 35/15 1.5 stalowa 465mm (500)	002911042	6
5	LG-V SET	Fixing element (1set=2pcs.)	001101683	6

Example 3. Wall-mounted enclosure 4XN160 3-7 with insert ready to install modular equipment and circuit breakers/disconnectors EB/ED 125, 160, 250A

Wall-mounted enclosure 4XN160 with IP41 degree of protection (it is possible to increase the degree of protection to IP44 by correct sealing SEAL-G9) 800 mm width, 1100 mm high, 160 mm depth. Enclosure suitable for mounting modular devices with total 252 moduls. In the following configuration, housing suitable for mounting 156 modules, 4 fuse-disconnectors NH00, 1 disconnecter/circuit breaker ED/EB 125, 160, 250A, perforated mounting plate for media application. The enclosure is divided vertically into fields: 1-st field (250 mm width) and 2-nd field (500 mm width). By using vertical bracket WP-A depth of the rails can be adjusted. An enclosure is mounted on the wall with UCH-2 holders.

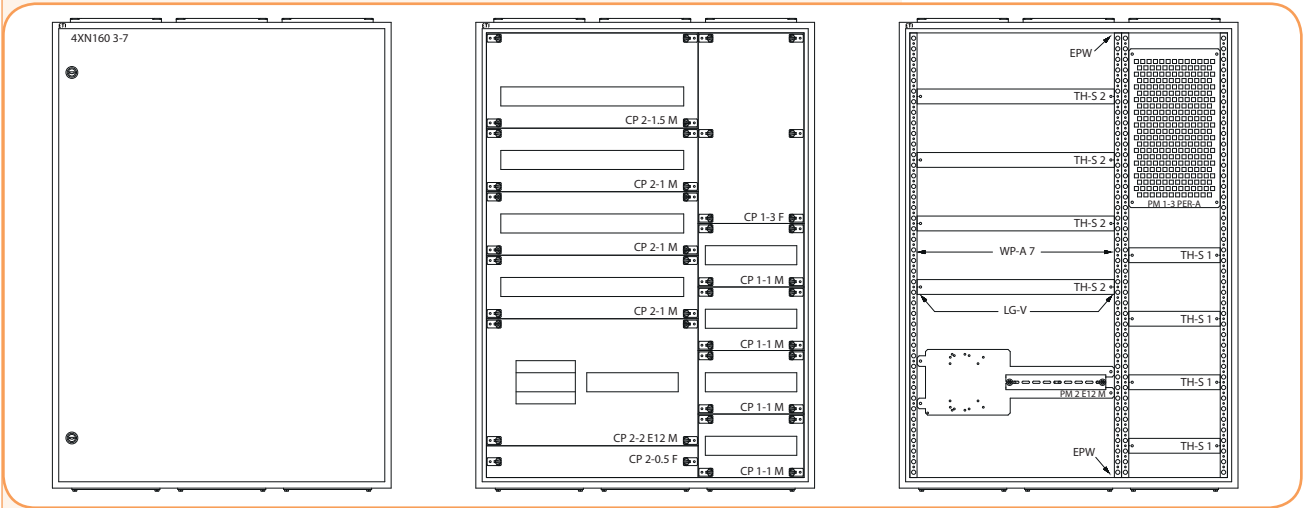

List of materials for 4XP160 3-7 enclosure with insert to modular equipment and circuit breakers/disconnectors EB/ED 125, 160, 250A

No.	Type	Product name	Code no.	Quantity to be ordered
1	4XN160 3-7	Wall-mounted enclosure empty, IP41, kl. I RAL7035 (800x1100x160)	001101409	1
2	CP 1-1 M	Modular cover 12 mod. (250x150)	001101451	4
3	WP-A 7	3 position vertical bracket Type A (1050) (1set=left and right)	001101650	2
4	CP 1-3 F	Plain cover (250x450)	001101443	1
5	CP 2-0.5 F	Plain cover (500x75)	001101426	1
6	CP 2-1 M	Modular cover 24 mod. (500x150)	001101453	3
7	CP 2-1.5 M	Modular cover 24 mod. (500x225)	001101459	1
8	CP 2-2 E12 M	Cover for 1xEB2/ED2 125,160,250A 3,4P and 12 mod. (500x300)	001101483	1
9	EPW	Dividing set (1set=2pcs.)	001101677	1
10	PM 1-3 PER-A	Perforated mounting plate Type A (250)	001101622	1
11	PM 2 E12 M	Mounting plate 1xEB2/ED2 with rail TH35 for 12 mod. (500)	001101572	1
12	TH-S 1	Mounting rail 35/15 1.5 steel 215mm (250)	002911040	4
13	TH-S 2	Mounting rail 35/15 1.5 steel 465mm (500)	002911042	4
14	UCH-2	Handle for enclosure hanging (1set=2pcs.)	001101715	1
15	LG - V SET	Fixing element (1set=2pcs.)	001101683	12

Example 4. Wall-mounted enclosure GT 100-60-25 with insert.

GT enclosure with IP65 protection 1000 mm high, 600 mm wide, 250 mm deep with insert for modular equipment and MCCB circuit breakers, disconnectors, fuse-disconnectors. The following set allows to install the equipment with total of 66 modules and 4 fuse-disconnectors NH00, 1 MCCB disconnector ED or circuit breaker EB 125, 160, 250A. There is also the possibility to install additional devices directly on the GT mounting plate besides insert (two levels of assembly).

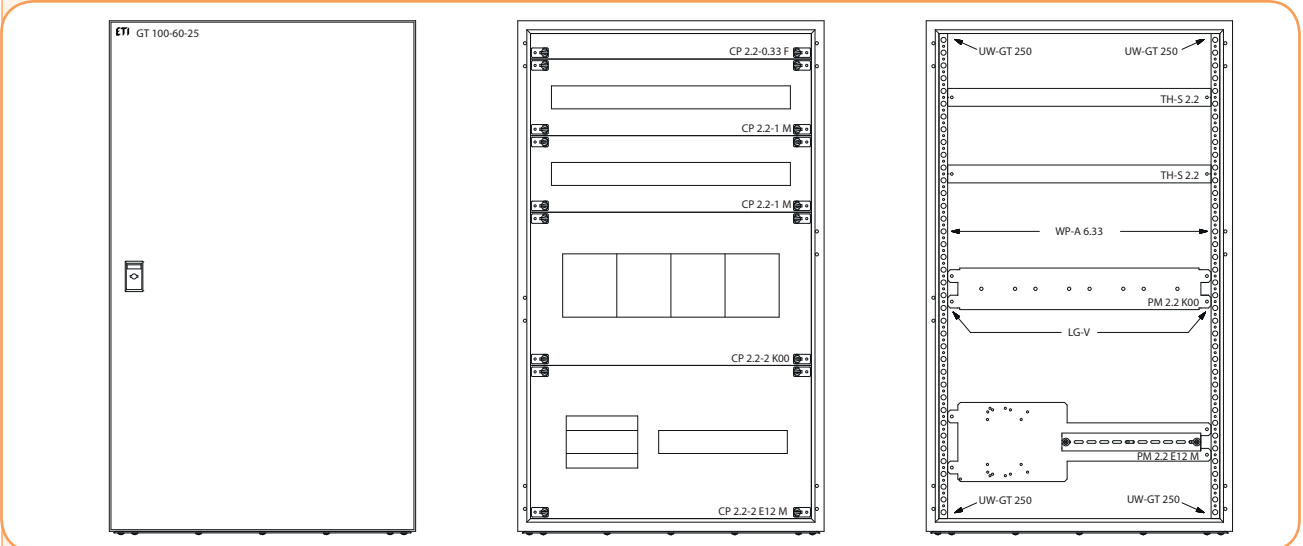

List of materials for GT 100-60-25 enclosure with insert to modular equipment and circuit breakers/disconnectors EB/ED 125, 160, 250A

No.	Type	Product name	Code no.	Quantity to be ordered
1	GT 100-60-25	Hermetic enclosure IP65	001102142	1
2	UW-GT 250	Holders for mounting plate GT depth 250mm (1set=4pcs.)	001101707	1
3	WP-A 6.33	3 position vertical bracket Type A (950) (1set=left and right)	001101649	1
4	CP 2.2-1 M	Modular cover 26 mod. (550x150)	001101454	2
5	CP 2.2-2 H00	Cover for 4xHVL00/LTL00 (550x300)	001101491	1
6	CP 2.2-2 E12 M	Cover for 1xEB2/ED2 125,160,250A 3,4P and 14 mod. (550x300)	001101484	1
7	CP 2.2-0.33 F	Cover (550x50)	001101422	1
8	TH-S 2.2	Mounting rail 35/15 1.5 steel 515mm (550)	002911043	2
9	PM 2.2 H00	Mounting plate 4xHVL00/LTL00 (550)	001101580	1
10	PM 2.2 E12 L12	Mounting plate 2xEB2/ED2 125,160,250A 3,4P or 2xLA1,2 (550)	001101587	1
11	LG-V SET	Fixing element (1set=2pcs.)	001101683	6

Notes

HXS STANDING ENCLOSURES (IP55, 65)

→ Unscrewed rear wall with polyurethane gasket ensures tightness of the housing and facilitates installation of wiring and equipment

→ Very high quality of polyurethane gasket thanks to the latest technology of pouring gaskets

→ Three-point door locking system with toothed mechanism and lever with the option of being equipped with a system or patent insert

→ A four-element plinth with a cable fixing bar. The plinths can be screwed together and combined to achieve the required height

→ The possibility of dividing the internal set with the apparatus vertically

→ Weaknesses in the side walls allow to carry cables and busbars when connecting enclosures into sets

→ As standard, the enclosures are equipped with membrane glands from the top and double aluminum from the bottom

HXS STANDING ENCLOSURES (IP55, 65)

Application - HXS system standing enclosures of the SOLID GSX series are available in three standard widths (550 mm, 800 mm, 1050 mm) and a depth of 300 mm (enclosure 1850 mm high) and 400 mm (enclosure with a height of 2000 mm). The enclosures have possibility to be equipped with mounting plates, internal sets with electric equipment and a power distribution system based on busbars. Thanks to dedicated mounting holes and weaknesses in the side walls, it is possible to connect the enclosures into sets and carry out wiring or busbars between the sections. Enclosures can be attached to the wall using dedicated openings in the back of the enclosures or brackets intended for that purpose. It is also possible to attach the enclosures to the floor thanks to mounting holes in the plinths.

Technical data	
Protection class	I
Degree of protection	IP55,65
Mechanical strength	IK10
Rated current	1600 A (depending on the busbars used)
Colour	Enclosures body: light gray (RAL 7035) Plinth: black (RAL 9005)
Paint	Polyester
Application	Indoor enclosures
Operating temperature	-5°C ... +40°C
Standards	PN-IEC/EN 62208 , PN-IEC/EN 60529, PN-IEC/EN 62262
Directives	RoHS

Mechanical load	
Internal set (WP-A / WP-U + LG-V + TH-S)	250 kg
Mounting plate (PM)	40 kg
Mounting plate (PM-G)	350 kg
Doors	10 kg

Advantages:

- High versatility and flexibility of configuration,
- Removable internal set (can be used in a workshop or in the building during installation),
- It is possible to divide the internal set vertically and horizontally,
- Covers and mounting plates dedicated to ETI equipment (circuit breakers, disconnectors, etc.),
- Quick assembly,
- Three-point door locking system with toothed mechanism and lever with the option of being equipped with a system or patent insert,
- Unscrewed rear wall with polyurethane poured gasket,
- High-quality diaphragm glands from the top and double aluminum from the bottom,
- A four-element plinth with a cable fixing beam. The plinths can be screwed together and combined to achieve the required height,
- Precision made of high quality powder coated steel sheet,
- Painted with polyester paint resistant to UV radiation.



Series of types of HXS enclosures and method of their marking

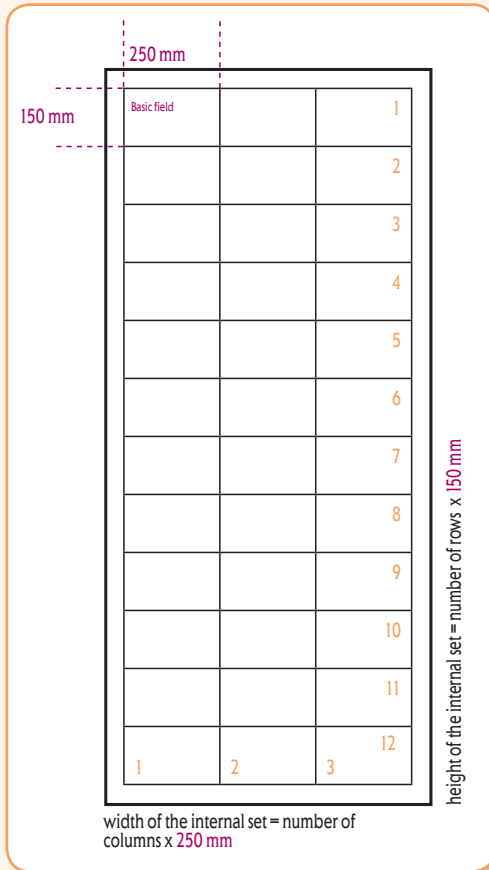

Overview Heights/Widths- Internal dividing for HXS enclosures

Range of sizes is based on DIN 43870 standard. Base module with devices cover has a width of 250 mm and a height of 150 mm. In this module you can install 12 modular devices with a width 18 mm. A code for the basic fields represent two digits separated by a dash of 1-1, where the first digit describes the width and the second height.

Other sizes multiples the basic fields (eg. 2-3 cover mean- width 500 mm, height 450 mm).

HXS standing enclosures occur in three window widths 2, 3, 4 (500, 750 and 1000 mm), depths: 300 mm and 400 mm and heights: 12 (1800 mm) and 13 (1950 mm).

Enclosures with width 2 can be divided in vertical configuration 1 + 1.

The width of the enclosure 3 can be divided in the configuration of 1 + 1 + 1, 2 + 1 or 1 + 2.

And width 4 enclosures can be divided into 1 + 1 + 1 + 1, 2 + 2, 1 + 1 + 2 etc.

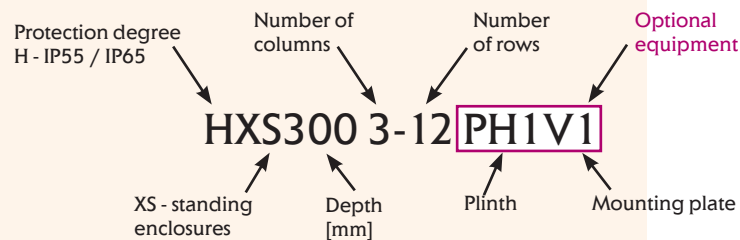

Enclosure types		External enclosure dimensions											
Type	Code no.	Degree of protection	Width (mm)	Height without plinth (mm)	Depth (mm)	Plinth (mm)	Mounting plate (mm)	Number of doors	The maximum number of modules (18 mm)	Maximum power loss P (W)	Weight (kg)	Packaging (pcs.)	
HXS300 series x-x PH1													
Empty standing enclosures with plinth - 300 mm of depth *													
HXS300 2-12 PH1	001325102	IP65	550	1850	300	100	-	1	12x24	288	251	54,81	1
HXS300 3-12 PH1	001325103	IP65	800	1850	300	100	-	1	12x36	432	328	70,25	1
HXS300 4-12 PH1	001325104	IP55	1050	1850	300	100	-	2	12x48	576	407	87,57	1
HXS300 series x-x PH1 V1													
Standing enclosures with mounting plate and plinth - 300 mm of depth *													
HXS300 2-12 PH1V1	001325502	IP65	550	1850	300	100	1x 500	1	12x24	288	251	70,36	1
HXS300 3-12 PH1V1	001325503	IP65	800	1850	300	100	1x 750	1	12x36	432	328	93,19	1
HXS300 4-12 PH1V1	001325504	IP55	1050	1850	300	100	1x 1000	2	12x48	576	407	124,83	1
HXS400 series x-x													
Empty standing enclosures without plinth - 400 mm of depth **													
HXS400 2-13	001327508	IP65	550	2000	400	-	-	1	13x24	312	306	65,53	1
HXS400 3-13	001327509	IP65	800	2000	400	-	-	1	13x36	468	395	82,14	1
HXS400 4-13	001327510	IP55	1050	2000	400	-	-	2	13x48	624	483	100,99	1

* Enclosures with a height of 12 (1850) and a depth of 300 mm are standard equipped with a plinth with a height of 100 mm,

** Enclosures with a height of 13 (2000) and a depth of 400 mm are not equipped as standard with a plinth (need to be ordered separately)

HXS300 2-12 PH1



Single door
Degree of protection IP65

HXS300 3-12 PH1



Single door
Degree of protection IP65

HXS300 4-12 PH1



Double door
Degree of protection IP55

Plinths for enclosures			External dimensions				
Type	Description	Code no.	Width (mm)	Height (mm)	Depth (mm)	Weight (kg)	Packaging (pcs.)
Plinths for 300 mm deep enclosures from the HXS300 series *							
PH1 D3-W2	Plinth 100 mm height and RAL9005 for HXS300 enclosures with width 2 (550)	001336910	550	100	300	3,49	1
PH1 D3-W3	Plinth 100 mm height and RAL9005 for HXS300 enclosures with width 3 (800)	001336912	800	100	300	4,38	1
PH1 D3-W4	Plinth 100 mm height and RAL9005 for HXS300 enclosures with width 4 (1050)	001336914	1050	100	300	5,24	1
Plinths for 400 mm deep enclosures from the HXS400 series **							
PH1 D4-W2	Plinth 100 mm height and RAL9005 for HXS400 enclosures with width 2 (550)	001336918	550	100	400	3,99	1
PH1 D4-W3	Plinth 100 mm height and RAL9005 for HXS400 enclosures with width 3 (800)	001336920	800	100	400	4,88	1
PH1 D4-W4	Plinth 100 mm height and RAL9005 for HXS400 enclosures with width 4 (1050)	001336922	1050	100	400	5,75	1

*Enclosures with a height of 12 (1850) and a depth of 300 mm are standard equipped with a plinth with a height of 100 mm,

**Enclosures with a height of 13 (2000) and a depth of 400 mm are not equipped as standard with a plinth (need to be ordered separately)



A four-element plinth
with a cable fixing bar

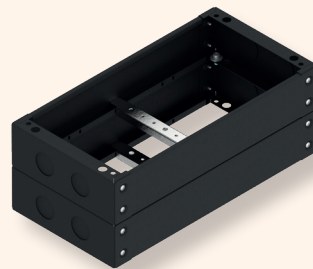

The plinths can be screwed together and
combined to achieve the required height,

HXS300 2-12 PH1 enclosure components (standard equipment)

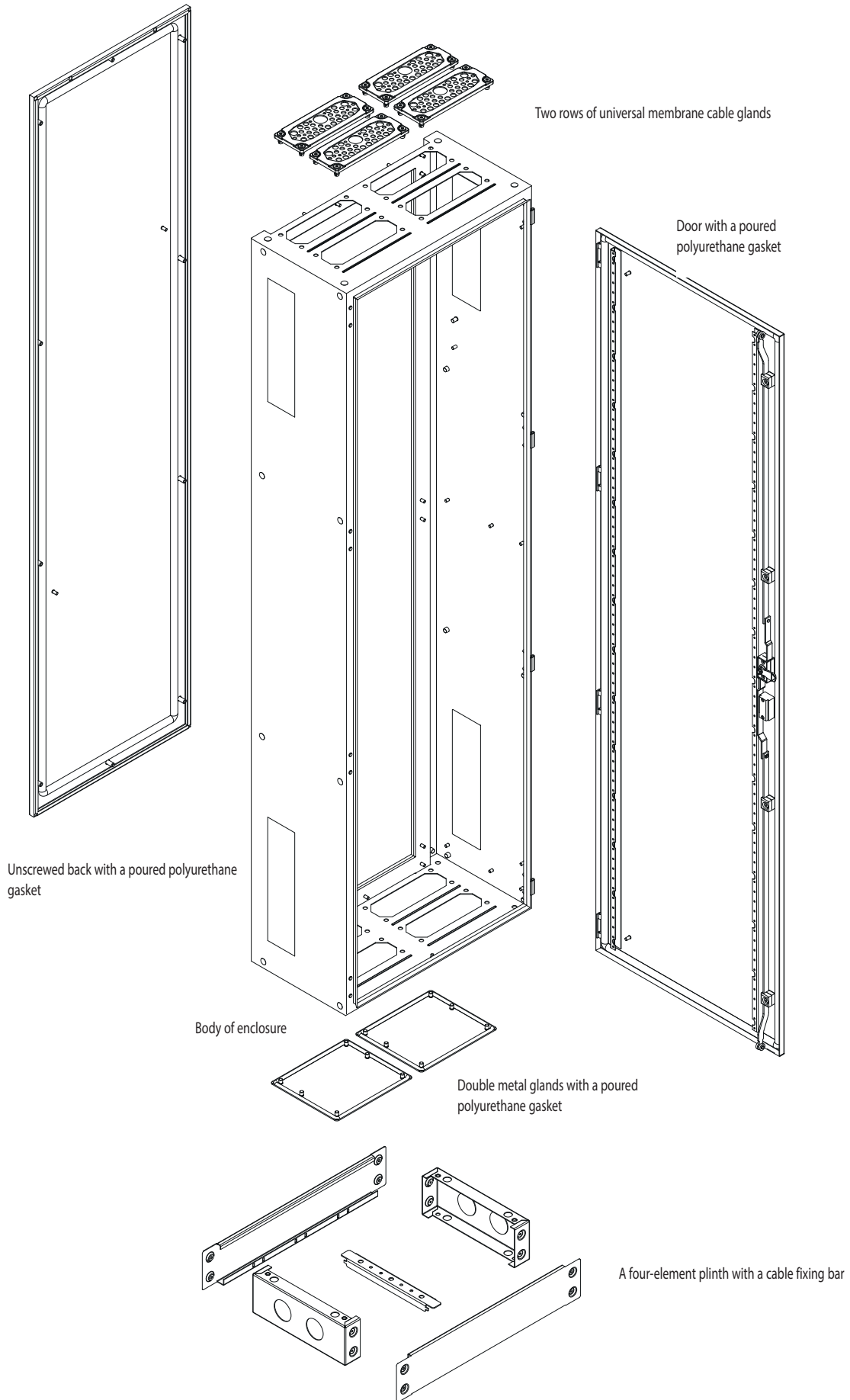

HXS400 2-13 enclosure components (standard equipment)

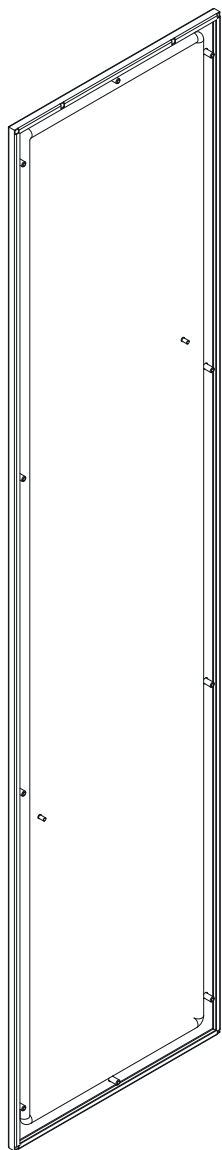

Unscrewed back with a poured polyurethane gasket

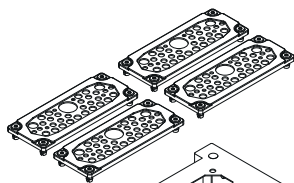

Two rows of universal membrane cable glands

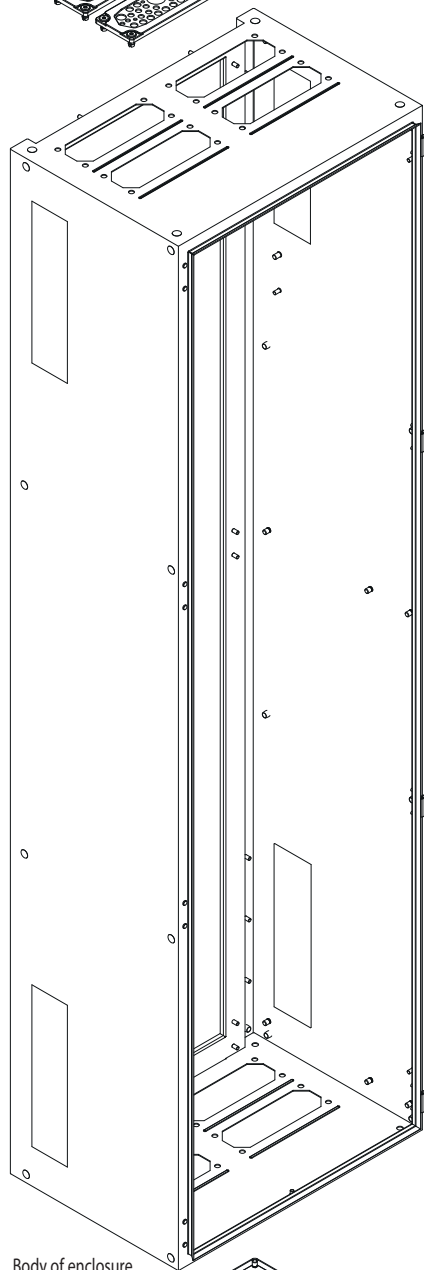

Body of enclosure

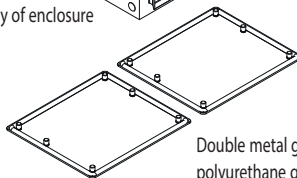

Double metal glands with a poured polyurethane gasket

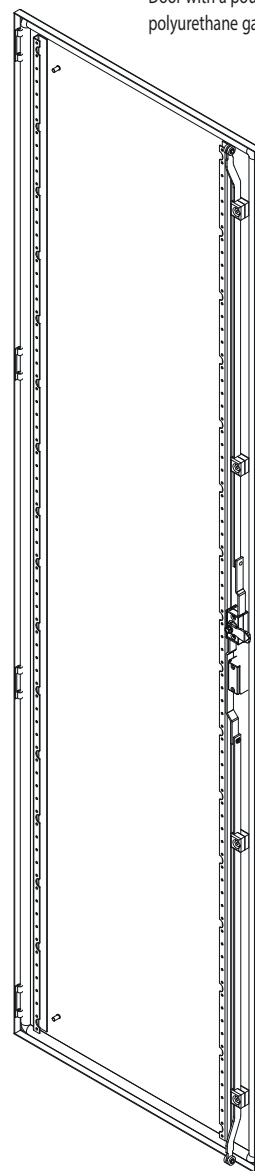

Door with a poured polyurethane gasket

Advantages and technical characteristics:

Three-point locking system



The enclosures of the HXS series are equipped as standard with a three-point locking system with a toothed mechanism and a lever, which enables the installation of various types of system and patent inserts. The closing system is equipped with profiled bands embedded in independent gibs. At the ends of the bands, rollers are fastened, which ensure even pressure of the door to the enclosure and do not introduce additional resistance to movement. The closing system has been designed in such a way as to ensure comfort of use and to meet technical requirements for enclosures with a high degree of IP protection.

Construction solutions that facilitate prefabrication



The use of consistent solutions and elements in the entire SOLID GSX system makes it much easier to assemble and manufacture. Uniform self-tapping screws and bolts allow for a less frequent tool change, and many small positioning details and markers shorten assembly time.

Depth adjustment of installed equipment



Special construction of mounting brackets allows for step adjustment of the installation depth of the insert sets in a very wide range.

Possibility to divide the internal set horizontally and vertically



The EP-W dividing elements and BL WP dividing bars give complete freedom during configuration the internal sets.

Removable internal sets



The SOLID GSX system enables simple assembly and disassembly of entire inserts with equipment and cabling in enclosures.

Plinths



PH plinths are screwed from four elements (front element, rear element and two side elements). In addition, each plinth is equipped with a bar for fixing wires and cables.

Both the front and rear element can be unscrewed, making wiring easier. In the side elements of the plinth, weaknesses were made to remove the plugs and lead the wires between the plinths in the enclosures combined together.

The plinths are symmetrical, this means that two or more plinths can be twisted together to achieve the target heights. The standard height of the plinth is 100 mm.

Membrane cable gland



The use of modern gland plates allows the introduction of wires without single cable glands and without the use of special tools. The full range of diaphragm cable glands for different cable cross-sections can be found on page 95.

Steel cable gland



It allows to use cables and wires with larger crosssections (appropriate cable glands)

Double metal cable gland

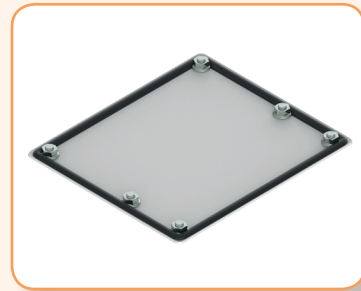

Double gland plates allow for faster assembly and to lead wires with larger diameters. When screwed into standard locations they cover two adjacent openings for mounting gland plates.

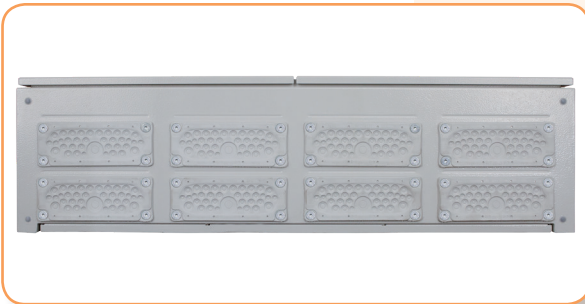

The holes for the gland plates (FL21 standard) are made in two rows. The number of holes depends on the width of the enclosure. On pages 44 and 46 there are tables and dimensional drawings with arrangement of plinths. As standard, HXS enclosures are equipped with two rows of membrane gland plates screwed with M8 bolts from the top (EH-TKC-36-S).



HXS enclosures are equipped with double metal gland plates from the bottom. The poured gasket ensures a high degree of IP protection. The glands cover two adjacent openings in the FL21 standard. Each EH2 gland has M8 dowels fixed permanently and it is screwed with flange nuts from the center of the enclosure, which considerably facilitates their assembly and shortens the prefabrication time.

Accessories for HXS standing enclosure



U400
001102166



UCH-2
001101715



LK-WRS-D3
001343100



LK-WRS-D5
001343101



LK-WRS-KW8
001343103



LK-WRS-T9
001343104



LK-WRS-1333
001343102



KEY-D5-M
001102173



KEY-T9-M
001102174



KEY-KW8-M
001102175



KEY-UNI-M
(For locks D5, T9, KW8, N)
001102176



KEY-1333
001343000



LPE-6
001102177

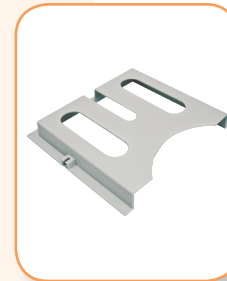

K-A4
001102178



K-A4-PT
001343200



FA-RAL7035
001101710

The rest accessories and equipment can be found in chapter "ACCESSORIES AND INTERNAL CONSTRUCTION SYSTEM" on page 65.

The possibility of any configuration of the internal set



ETIBOX

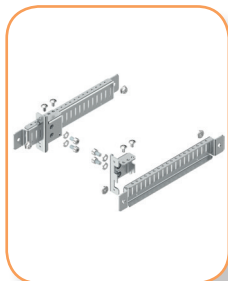

Internal set holders
page. 86

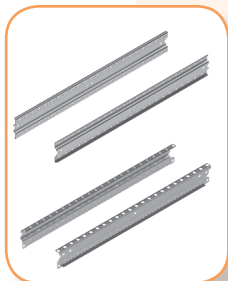

WP-A/WP-T vertical
brackets
page. 85

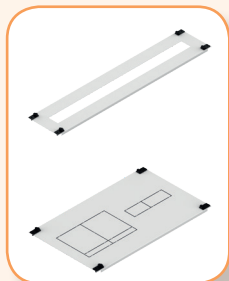

CP covers
page. 72



TH-S rails
page. 80

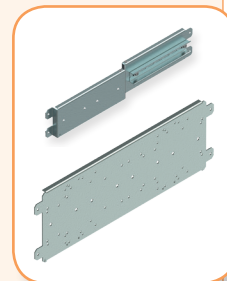

PM mounting plates
page. 80

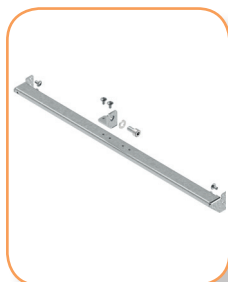

BL-WP bars for dividing
horizontally
page. 87

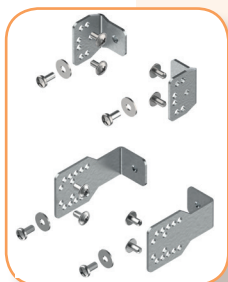

LG-V fixing elements
page. 91

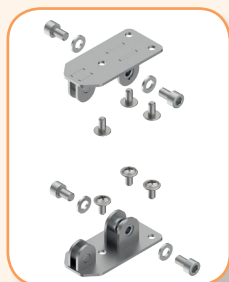

EP-W internal set
dividing elements
page. 87



UW-SEP support
dividing element
page. 87

The rest accessories and equipment can be found in chapter "ACCESSORIES AND INTERNAL CONSTRUCTION SYSTEM" on page 65.

Internal HXS enclosures equipment

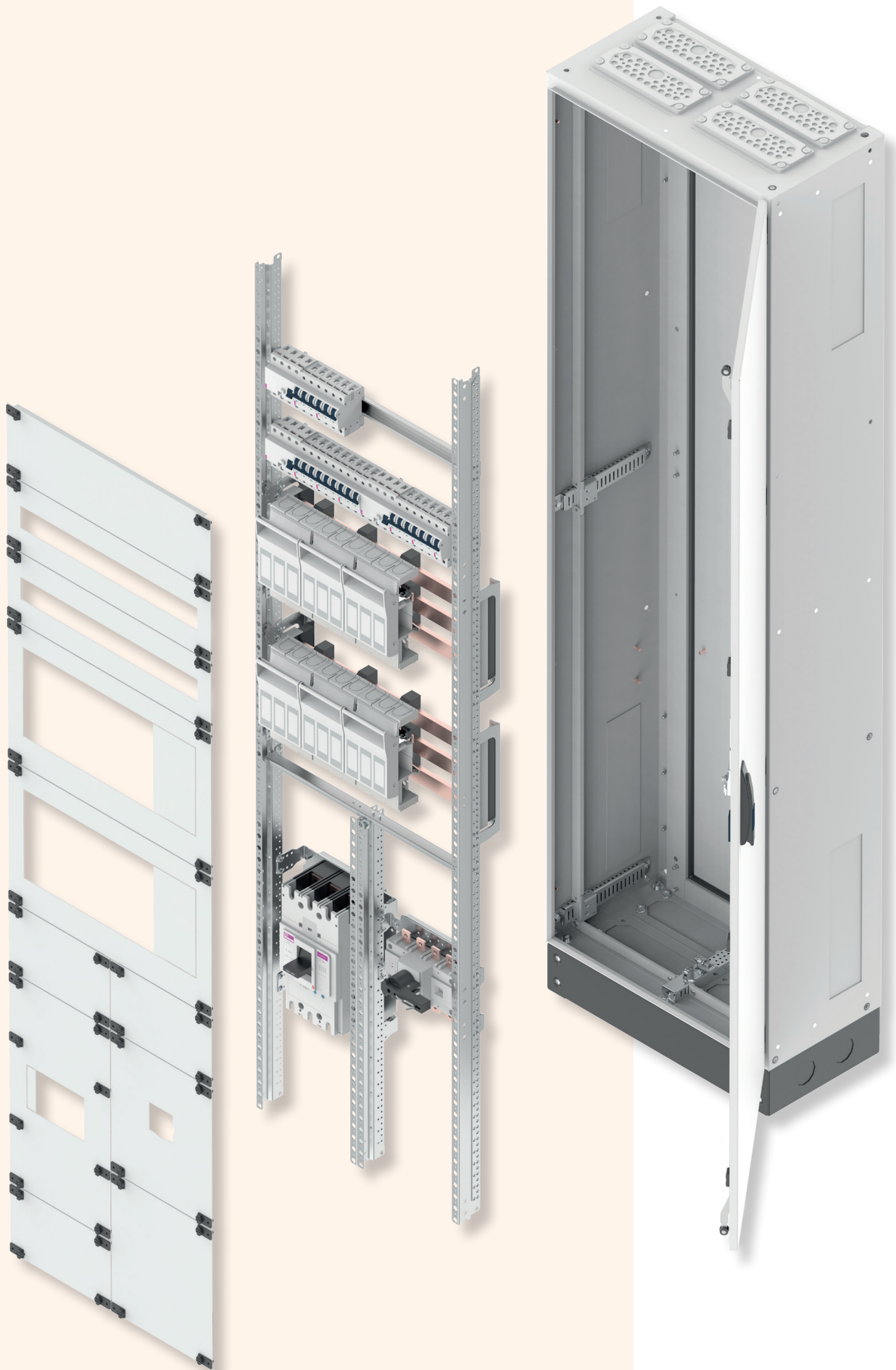

Selected type of equipment that can be mounted according to the assembly instructions in HXS enclosures:

Type of equipment	Covers	Mounting plates and rails
Serial terminals	CP x-x F	TH-S x
Non-standard equipment	CP x-x FP	PM x-x PER-A lub PM-F x-24
Modular equipment	CP x-x M	TH-S x
HVL EK 00 disconnectors and modular equipment up to 160 A	CP x-x H00 M	PM x H00 M
KVL00 disconnectors and modular equipment up to 160 A	CP x-x K00 M	PM x K00 M
ED2 / EB2 125, 160, 250 A Switch disconnectors / Circuit breakers and modular equipment	CP x-x E12 M	PM x E12 M
LBS1 disconnectors up to 160 A and modular equipment	CP x-x S1 M	PM x E12 M
HVL EK 00 disconnectors up to 160 A	CP x-x H00	PM x H00
KVL00 disconnectors up to 160 A	CP x-x K00	PM x K00
KVL1 disconnectors up to 250 A	CP x-x K1	PM x ELS46 K123
KVL2 disconnectors up to 400 A	CP x-x K2	PM x ELS46 K123
KVL3 disconnectors up to 630 A	CP x-x K3	PM x ELS46 K123
ED2 / EB2 125, 160, 250 A Switch disconnectors / Circuit breakers	CP x-x E12	PM x E12 L12
ED2 / EB2 400, 630 A Switch disconnectors / Circuit breakers	CP x-x E46	PM x ELS46 K123
LBS1 disconnectors up to 160 A	CP x-x S1	PM x E12 L12
LBS2 disconnectors up to 250 A	CP x-x S2	PM x E12 L12
LBS3 disconnectors up to 630 A	CP x-x S3	PM x ELS46 K123
SL00/1/2/3 strip type fuse-switch-disconnectors	CP x-x SL	-

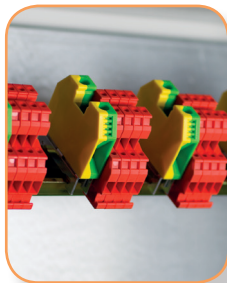

Serial terminals

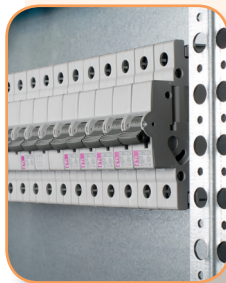

Modular equipment

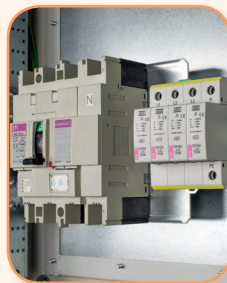

EB2 160 circuit breaker and modular equipment



HVL EK 00 disconnector



KVL00 disconnector



KVL1 disconnector



LBS 250 A disconnector



EB2 400 A circuit breaker

Dimensional drawings

Body of HXS300 enclosures

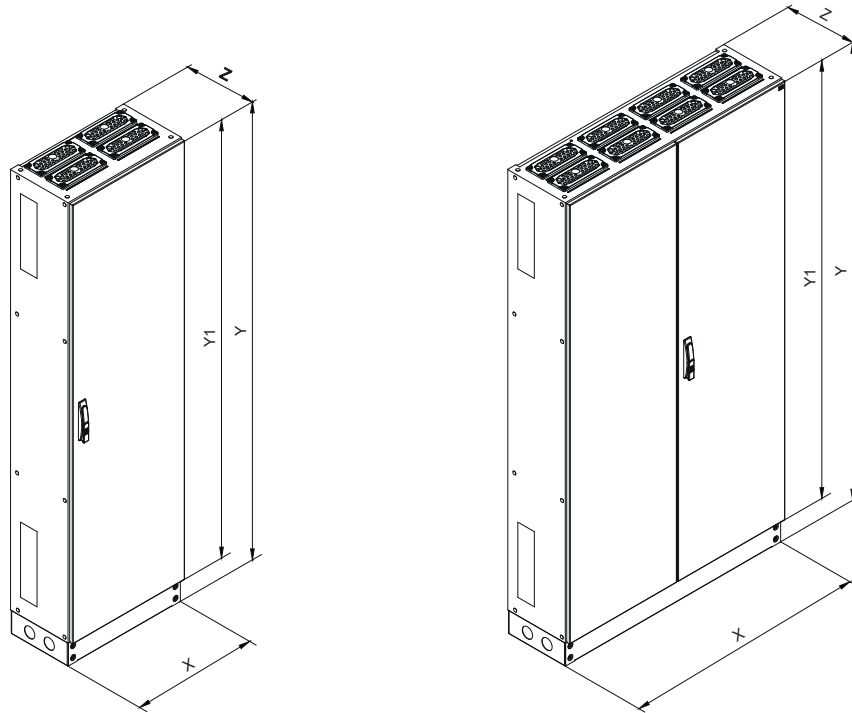

Type	X (mm)	Y (mm)	Y1 (mm)	Z (mm)	Number of doors
HXS300 2-12	550	1950	1850	300	1
HXS300 3-12	800	1950	1850	300	1
HXS300 4-12	1050	1950	1850	300	2

Holes for cable glands

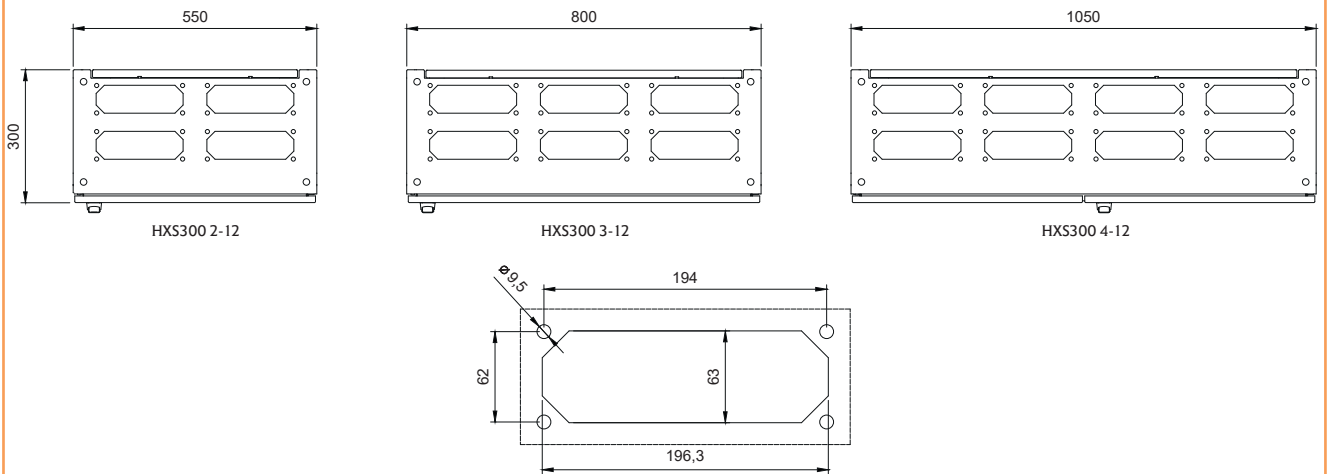

Type	Number of cable glands in enclosures	
	Top (diaphragm cable gland)	Bottom (double metal cable gland)
HXS300 2-12	4	2
HXS300 3-12	6	3
HXS300 4-12	8	4

Internal dimensions of HXS300 enclosure with UA-B, UW-BCU 23 and UW-BCR 3 handles

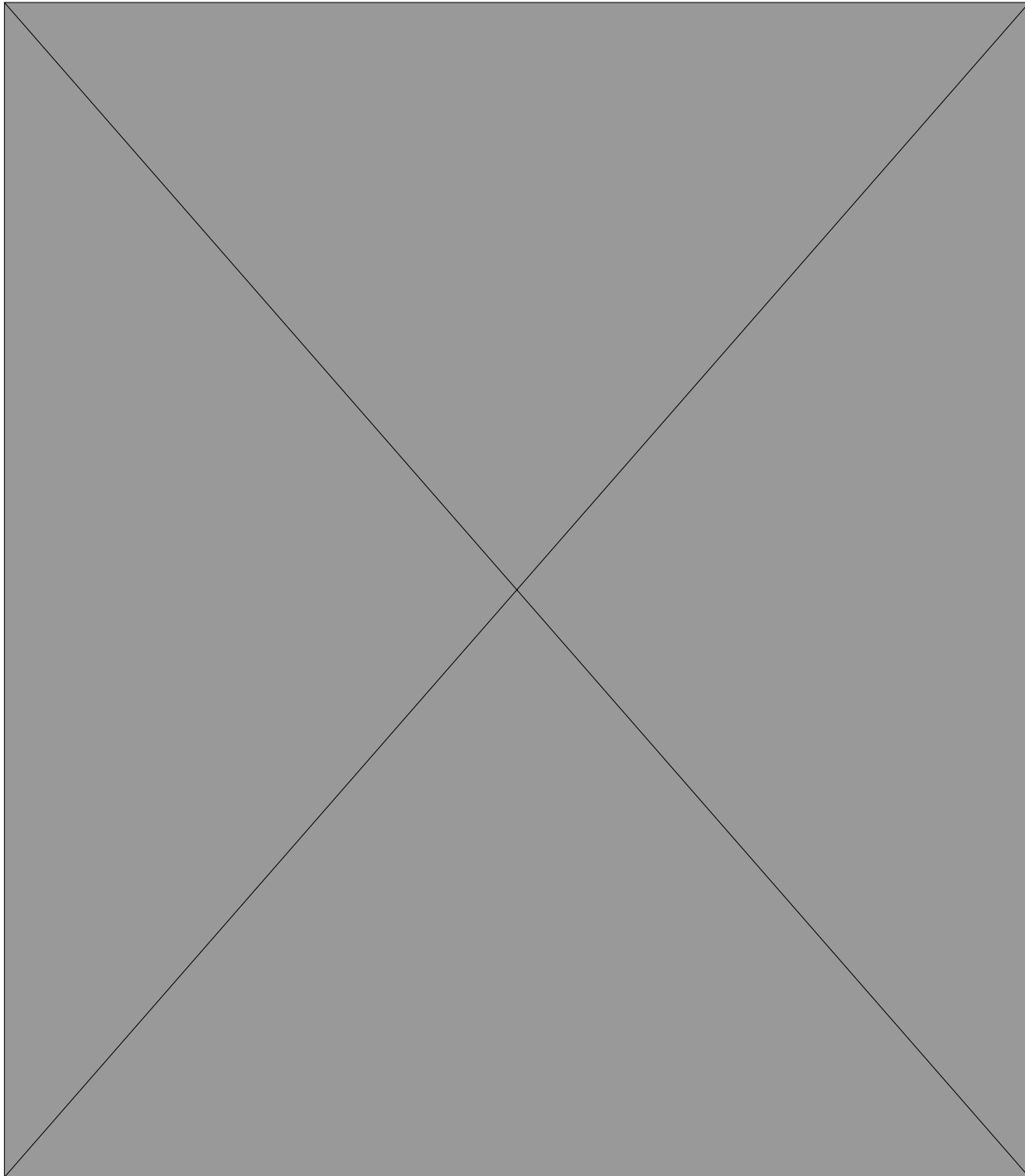

Enclosure with UA-B brackets for PM-G mounting plate

Enclosure with UW-BCU 23 handles for WP-A vertical supports

Enclosure with UW-BCR 3 handles for WP-A and WP-T vertical supports

Typical dimensions depending on the chosen mounting position of the internal set with equipment

Mounting position	For UW-BCU 23 handles			For UW-BCR 3 handles		
	A (mm)	B (mm)	C (mm)	D (mm)	E (mm)	F (mm)
1	60	216	234	60	216	234
2	-	-	-	70	206	224
3*	80	196	214	80	196	214

The given dimensions do not take into account the distance to the lock mechanism
 * basic position (see page 101)

Body of HXS400 enclosures

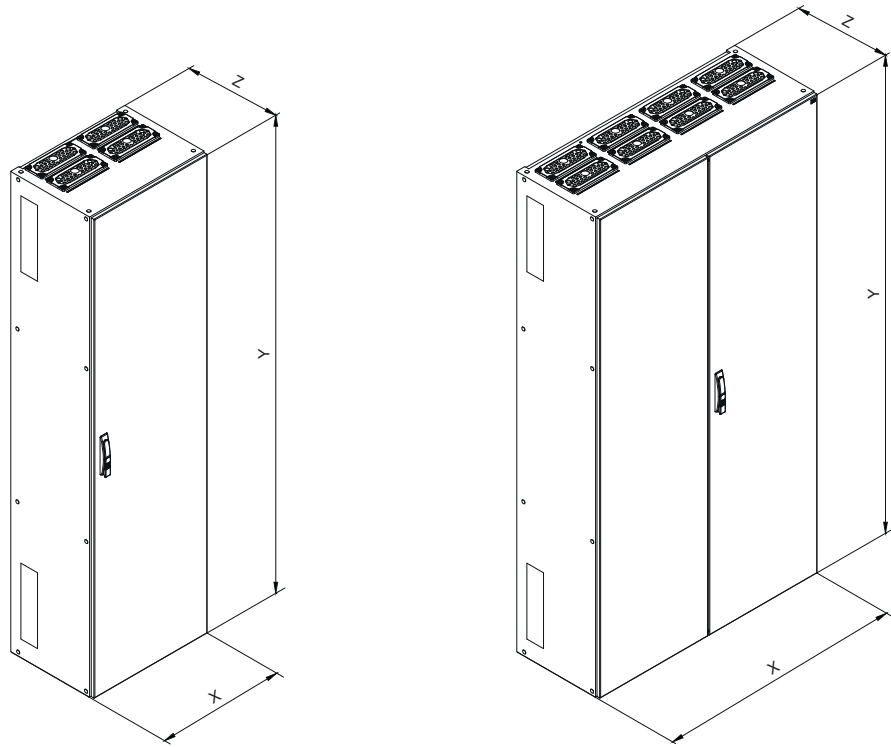

Type	X (mm)	Y (mm)	Z (mm)	Number of doors
HXS400 2-13	550	2000	400	1
HXS400 3-13	800	2000	400	1
HXS400 4-13	1050	2000	400	2

Holes for cable glands

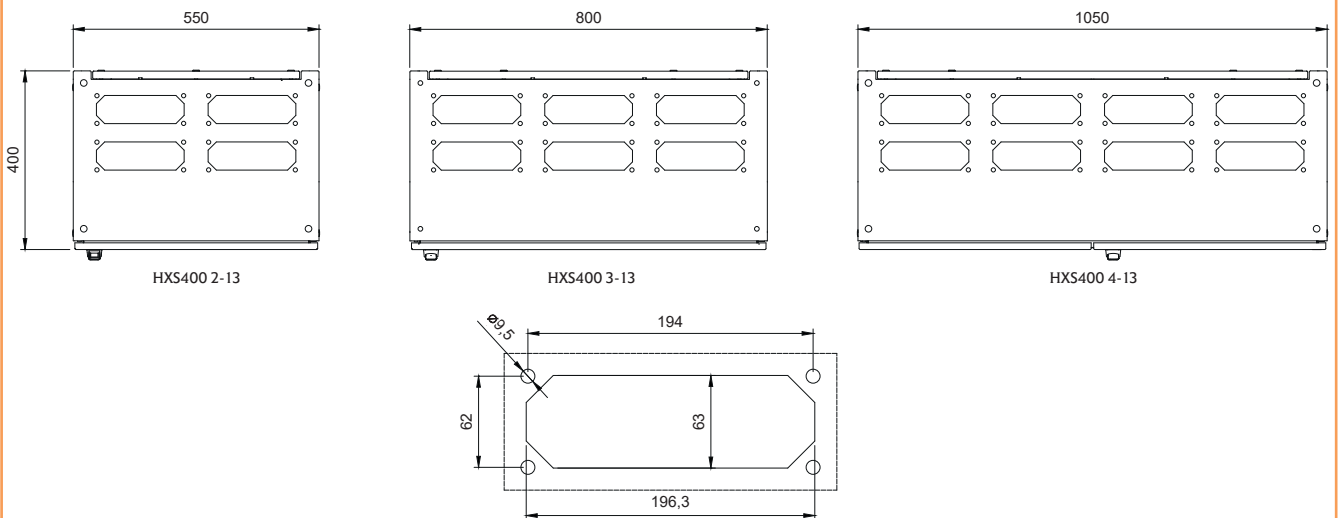

Number of cable glands in enclosures		
Type	Top (diaphragm cable gland)	Bottom (double metal cable gland)
HXS400 2-13	4	2
HXS400 3-13	6	3
HXS400 4-13	8	4

Internal dimensions of HXS400 enclosure with UA-B, UW-BCU 4 and UW-BCR 4 handles

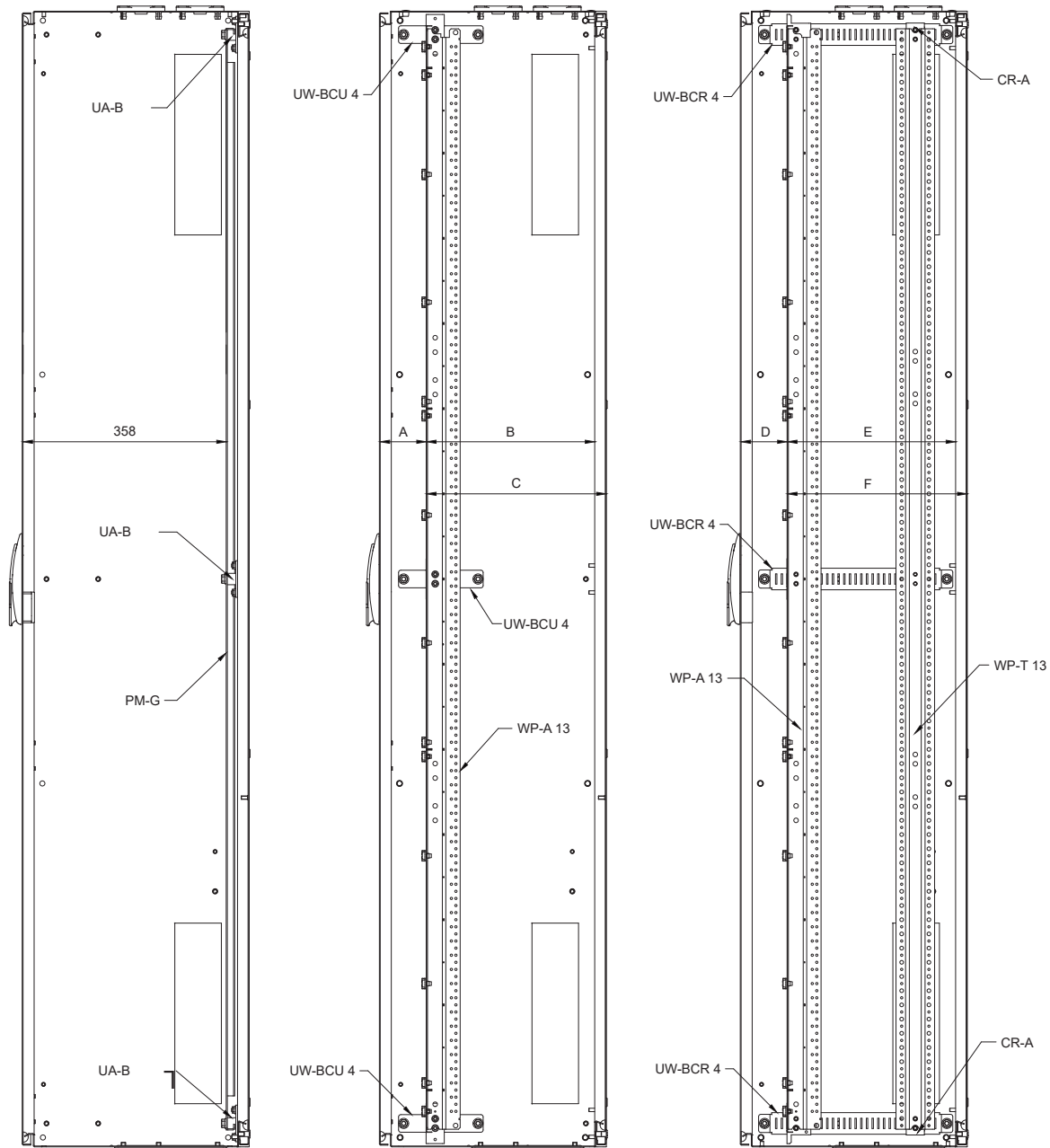

Enclosure with UA-B brackets for PM-G mounting plate

Enclosure with UW-BCU 4 handles for WP-A vertical supports

Enclosure with UW-BCR 4 handles for WP-A and WP-T vertical supports

Typical dimensions depending on the chosen mounting position of the internal set with equipment

Mounting position	For UW-BCU 4 handles			For UW-BCR 4 handles		
	A (mm)	B (mm)	C (mm)	D (mm)	E (mm)	F (mm)
1	-	-	-	60	316	334
2	-	-	-	70	306	324
3	80	296	314	80	296	314
4	-	-	-	90	286	304
5*	100	276	294	100	276	294
6	-	-	-	110	266	284
7	-	-	-	120	256	274
8	-	-	-	130	246	264
9	-	-	-	140	236	254
10	-	-	-	150	226	244

The given dimensions do not take into account the distance to the lock mechanism
 * basic position (see page 101)

Accessories and internal construction system

- Ability to install mounting rails at an angle
- Vertical brackets: WP-A with adjustable depth of mounting plates and the possibility of dividing the enclosure vertically and WP-U without depth adjustment and without the possibility of dividing the enclosure (economic version)
- Earthing terminals in CP covers for protection against electric shock
- Covers painted with polyester paint resistant to UV radiation
- CP covers and PM mounting plates dedicated to ETI equipment (disconnectors, circuit breakers) - perforation in plates and weakening to cut in covers
- Fast and easy assembly of covers by the use of special clips with the possibility of sealing
- Universal self-tapping screw for fixing brackets, mounting plates, TH rails
- All mounting plates have a positioning hole in the bottom left corner
- Vertical dividing thanks to the EP-W element and horizontally thanks to the BL-WP dividing bars. Very easy assembly of the internal set

Accessories and internal construction system

The internal construction system and accessories allow to adapt the SOLID GSX enclosures to the requirements of various applications.

Dedicated CP covers and PM mounting plates enable the installation of various types of equipment without the need for additional drilling or cutting holes. A wide range of LG-V fixing elements allows to optimally adjust the mounting depth of the equipment. The EP-W dividing elements together with the BL-WP dividing bars make it possible to divide the internal set both vertically and horizontally. The main construction elements and accessories fit different types of enclosures from the SOLID GSX system.

In the internal construction system, it can be distinguished:

- full and modular CP covers
- dedicated CP covers
- TH-S mounting rails
- PM mounting plates
- PM-G mounting plates for standing enclosures
- WP-A, WP-U, WP-T and WD-K vertical supports
- LG-V, LG-V5, LG-V6 and LG-T6 fixing elements
- UW-GT, UW-BCU, UW-BCR, CR-A handles
- UW-SEP, EP-W, EP-A, BL-WP dividing elements
- LG-B60, UD-B60, LG-T-B 185 and LG-T-INH brackets with insulating supports for busbars
- EH-TKC, EH-TC, EH-ST, EH-AL cable glands
- locks, inserts and keys for enclosures
- wall brackets for enclosures
- pockets, gaskets, pliers
- bolts, nuts, washers.

Advantages:

- CP covers and PM mounting plates are dedicated to ETI devices (disconnectors, circuit breakers) – perforated plates and covers are prepared to quick cut-outs the holes
- Quick and easy covers installation the use of special sealable clips
- CP covers earthing pins ensure protection against electric shock
- Vertical dividing thanks to the EP-W element and horizontally thanks to the BL-WP dividing bars. Very easy assembly of the internal set
- Very easy assembly of the internal set
- Vertical brackets: WP-A with adjustable depth of mounting plates and the possibility of dividing the enclosure vertically and WP-U without depth adjustment and without the possibility of dividing the enclosure (economic version)
- Universal self-tapping screw for fixing brackets, mounting plates, TH rails
- Ability to install mounting rails at an angle
- Different Types of locks matching the entire system GSX
- Metal enclosures painted with polyester paint resistant to UV radiation

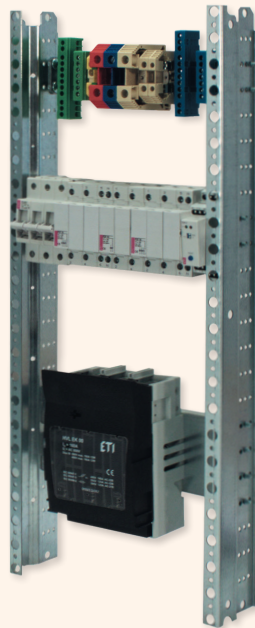
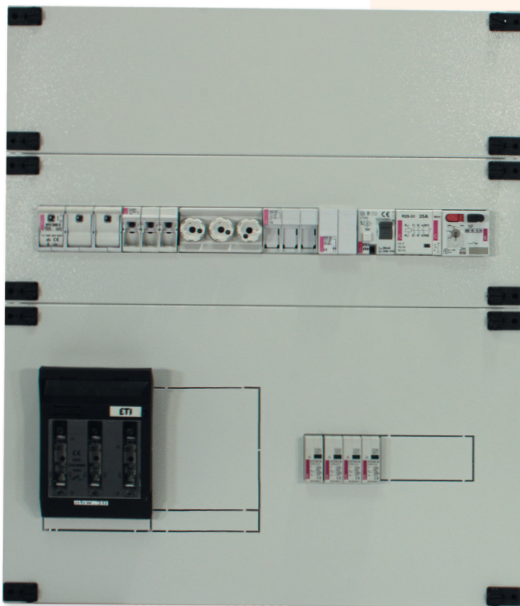

Advantages and technical characteristics

Covers CP

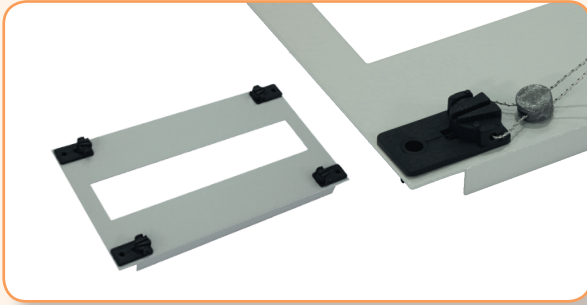

- CP covers are made of powder-coated sheet steel. All covers are equipped with earthing pins (if any equipment is mounted on the covers or insulating gaps are less than shown in EN 61439- 1 standard a cover grounding is recommended).
- CP covers are equipped with clips fastening in commercial set. Clips have the possibility of sealing. The special design of the clips allows easy and fast cover installation.

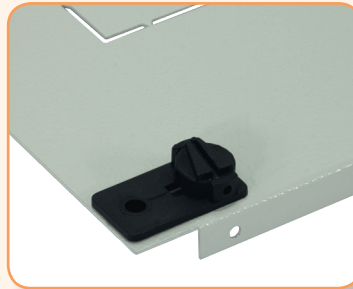
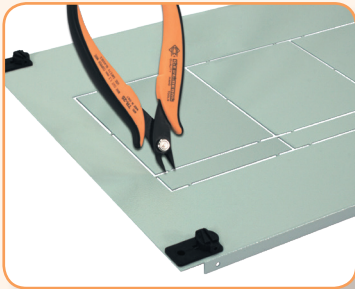

- The offer includes plain covers, covers matching to 45 mm modular equipment, covers dedicated for MCCB's EB/ED, disconnectors with fuses LTL/HVL/KVL, switch disconnectors type LA/LBS and combined with an additional 45mm holes for modular equipment.
- Special mounting plates are provided for dedicated covers. On pages 64 - 71 there are configuration tables to facilitate the selection of covers, plates and fixing elements for various types of equipment.
- Covers dedicated to EB / ED, LTL / HVL / KVL, LA / LBS types of equipment require installation in a specific positions. For ease of use, a positioning hole has been added, which should be found in the lower left corner.
- The covers have weaknesses for the cut-out to allow adjustment to various sizes of devices and configurations (different mounting depth, right-left). Weaknesses should be cut using CP-PLIER pliers adapted for this purpose.
- The method of fixing the electrical equipment, covers and mounting plates to brackets is included in the appropriate assembly instructions supplied with the CP shields (instructions are also available on the website www.etipolam.com.pl).

CP-B additional covers



- CP-B additional covers allow to complete the elevation of HXS enclosures between the enclosure body and the internal set.
- Vertical CP-BV additional covers should be selected depending on the height of the enclosure. They are sold in sets of 4 pieces.
- Horizontal additional covers are available in the divided versions: CP-BH and CP-BHS., Both versions are selected depending on the enclosure width. They are sold in sets (top + bottom set).
- Horizontal divided additional covers are dedicated to HXS enclosures with a divided internal set. They can also be used in enclosures without dividing the internal set by twisting the individual parts of the enclosures together (enclosure connectors included).

TH35 mounting rail

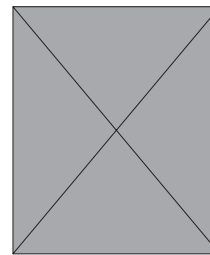
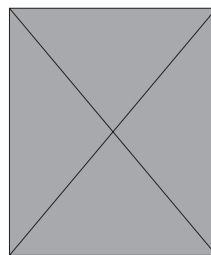
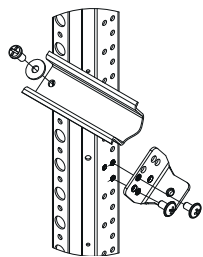

- The mounting of TH-S rails is possible at different distances from the cover (using the LG-V bracket: the minimum distance of the rail from the cover is 42.5 mm, the basic mounting distance is 48.5 mm, the maximum 64.5 mm; V5 minimum distance is 70 mm, basic mounting distance 76 mm, maximum 92 mm).
- It is also possible to mount the TH-S rail at an angle in vertical deflection. This facilitates the approach with wires to the terminals of connectors mounted on the rail.

PM mounting plates

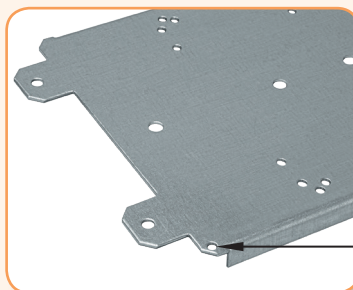
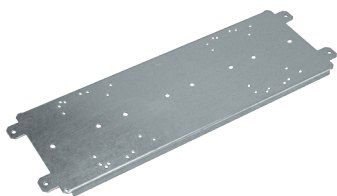

- Mounting plates are made of galvanized steel sheet with a thickness of 1.5 to 3 mm. The plates have holes for mounting ETI electrical equipment. In mounting plates intended for disconnectors and circuit breakers EB / ED, LTL / HVL / KVL, LBS with modular equipment, a TH rail with a height of 15 mm is installed. As well as the covers, the mounting plates have a positioning hole, which after installation should be in the lower left corner.
- To improve stiffness, the plates have bent edges.
- To attach the electric equipment to the mounting plate, you must purchase appropriate screws, nuts and washers. EB circuit breakers and ED disconnectors up to 250 A have M4 screws included (2 pieces, 3-pole version, 4 pieces 4-pole) without nuts and mounting washers.
- Mounting plates for WP-A vertical supports are fastened with LG-V, LG-V5, LG V6-B, LG-V6-D or LG-V6R-B elements. The method of fixing the electrical equipment, covers and mounting plates to brackets is included in the appropriate assembly instructions supplied with the CP shields (instructions are also available on the website www.etipolam.com.pl).

PM-G mounting plates



PM-G mounting plates are designed for HXS300 and HXS400 standing enclosures.

- They are available in four widths: 250 mm, 500 mm, 750 mm and 1000 mm and in two heights: 1800 mm and 1950 mm.
- The height of the mounting plates should be selected in accordance with the enclosure height. PM-G x-12 mounting plates are designed for enclosures with a height of 12 (1850) and PM-G x-13 mounting plates for enclosures with a height of 13 (2000).
- It is allowed to use several mounting plates in one enclosure, provided that their total width does not exceed the width of the enclosure. In this case, it is necessary to use a stiffening bar ensuring the possibility of screwing the plates in the center of the enclosure. Stiffening bars are available in the BL-UA version mounted on the back of the enclosure and BL-UR with the possibility of adjusting the mounting depth (page 89)
- The plate rim is double bent (forming the shape of the "U" letter) which significantly increases the strength and allows a wider range of applications.
- The mounting plates are mounted in six points on the "back" of the enclosure or on the brackets enabling the adjustment of the installation depth.
- All PM-G mounting plates have markers to be drilled with a $\varnothing 8$ drill to support it with the stiffening bar.

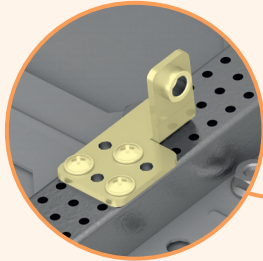

→ EP-A dividing elements

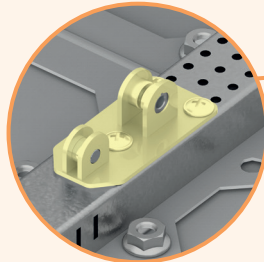

→ EP-W dividing elements

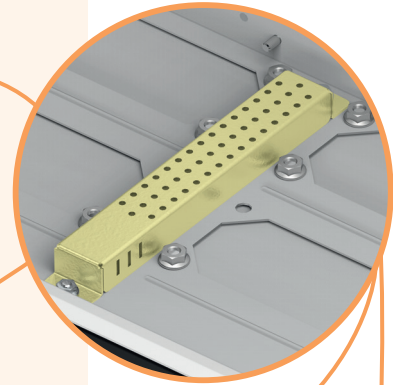

→ UW-SEP supports enable vertical dividing in HXS enclosures

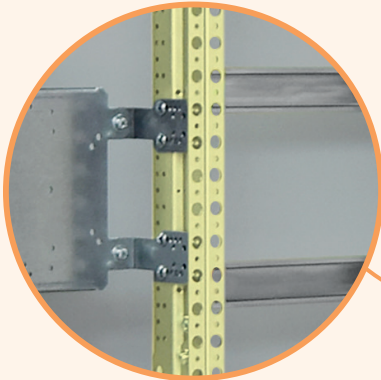

→ WP-A vertical supports are available in heights from 300 to 1950 mm



→ BL-WP division bars enable the separation of horizontal equipment sections. They guarantee orderly layout of devices and the lack of unused space in enclosures

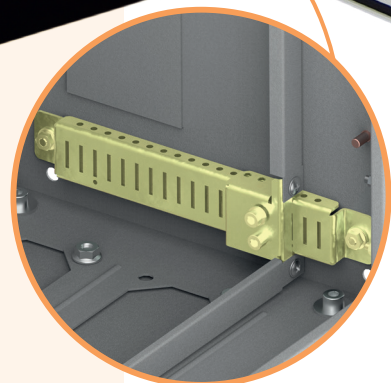

→ The UW-BCR handles allow for depth step adjustment of the internal set with electrical equipment

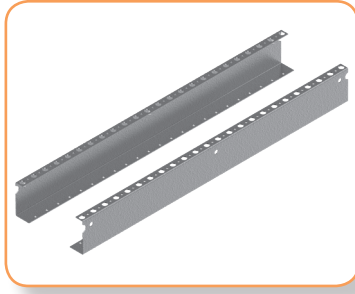
WP-U vertical supports

- Economical version of the vertical support without the possibility of dividing the enclosure and adjusting the mounting depth of TH-S rail and PM mounting plates. Fixed distance of TH-S rail to the covers, which is 48.5 mm.
- TH-S rails and PM mounting plates are mounted directly to the WP-U bracket using AST 4.8x9.5 self-tapping screws without the need to use LG V fixing elements.
- The brackets are fixed to the enclosure with M6x10 Allen screws supplied with a 4XN / 4XP enclosure.
- To mount the electrical equipment to the mounting plate, there is need to purchase the appropriate screws, nuts and washers. EB circuit breakers and ED disconnectors up to 250 A have M4 screws included (2 pieces, 3-pole version, 4 pieces 4-pole) without nuts and mounting washers.

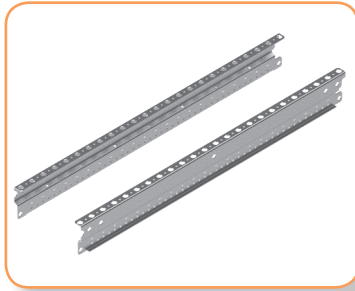
WP-A vertical supports

- The special design of the WP-A vertical support enables the assembly of the electrical equipment at various depths. Adjustment is possible thanks to the perforation of the bracket and LG-V elements in various variants. The TH-S assembly rails and PM mounting plates are attached to the LG-V element. The plates and rails are screwed to the LG-V elements with metric bolts.
- The design of the WP-A vertical support enables step mounting adjustment of TH-S rail, PM mounting plates and CP covers. The vertical adjustment is 25 mm, while the depth regulation of the TH-S rail and the PM mounting plates is 8 mm or alternately 6 mm and 2 mm (this is done thanks to the additional holes in the LG-V element).
- Opening the brackets gives the switchgear manufacturer the opportunity to choose the optimal distance between the equipment and covers.
- On the WP-A bracket, additional holes were provided to facilitate the determination of the mounting position of TH-S and PM plates. The spacing between openings is 150 mm and 75 mm.
- The bracket is fixed to the enclosure by means of allen screws M6x10 supplied with 4XN / 4XP enclosure or with internal set holders for GT or HXS enclosures.
- The brackets are packed in sets (left and right)

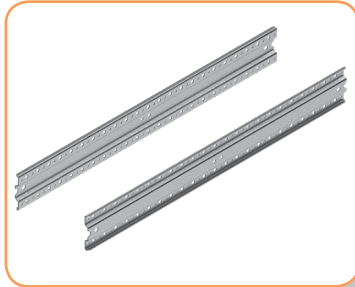
WP-T vertical supports

- The reinforced design of the WP-T vertical supports allows for the installation of heavy electrical equipment or busbar sets in HXS standing enclosures.
- The brackets can be mounted individually or as additional, rear brackets behind already installed WP-A brackets. This solution significantly facilitates the distribution of power in the switchgear and allows the busbar to be moved between each enclosures when several enclosures are combined into sets.
- WP-T brackets do not enable the assembly of CP covers.
- Available in three heights: 7 (1050 mm), 12 (1800 mm) and 13 (1950 mm).
- The brackets are packed in sets of 2 pieces.

WD-K rear support

- WD-K rear support made of 2 mm thick sheet metal with perforation adapted to cage nuts allows mounting of busbar insulators with 100 and 185 mm spacing in HXS standing enclosures.
- Available in two heights: 12 (1800 mm) and 13 (1950 mm).
- The height of the bracket should be selected in accordance with the height of the enclosure in which it is to be mounted.
- WD-K brackets can be mounted directly on the rear wall of the enclosure on UA-B-WD brackets or providing the possibility of adjusting the depth on the UR-B-WD brackets. To mount the WD-K brackets in the middle of the enclosure, use the UA-S bracket (mounting on the back wall) or UR-S (depth adjustment assembly).
- To stiffen the structure and support WD-K brackets in the middle of the enclosure, use a BL-UA stiffening bar (rear wall mounting) or BL UR (depth adjustment assembly) with brackets intended for WD-K brackets (BU-WD holder)
- WD-K brackets are symmetrical and sold in 1 piece without cage nuts, which must be ordered separately (cage nuts available on page 100)

UW-GT internal set holders

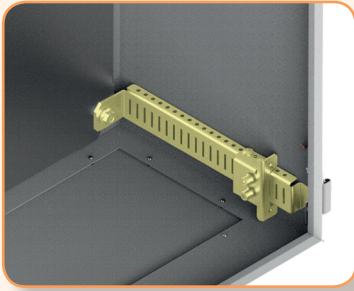

- The UW-GT internal set holder extends the capabilities of the universal GT hermetic enclosures and enables mounting in these enclosures a internal set with equipment on a WP-U or WP-A brackets.
- The set includes a set of holders for one GT enclosure.
- The UW-GT handle should be selected depending on the depth of the enclosure in which it will be mounted.
- UW-GT handles with depths of 300 mm and 400 mm provide the possibility of adjusting the depth of installation of the internal set with the equipment with a step of 10 mm.

UW-BCU internal set holders

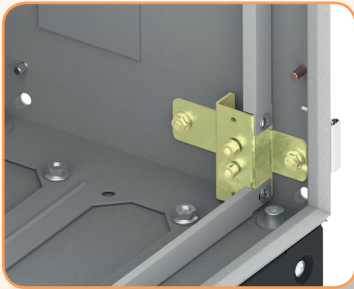

- The simple design of the UW-BCU handle allows you to easily mount the WP-A vertical supports in HXS standing enclosures. The handle can be rotated by 180° increasing the space between the door and the covers by an additional 20 mm.
- In each UW-BCU set there are two holders with nuts, bolts and washers necessary for mounting in the enclosure.
- For enclosure with a height of 12 (1800 mm) and 13 (1950 mm), 6 handles (3 sets of UW-BCU) should be used.

UW-BCR internal set holders

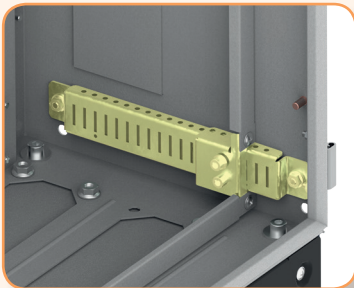

- UW-BCR handle is an alternative solution for mounting WP-A brackets in HXS standing enclosures. The construction of the handle provides a step adjustment of the installation depth by 10 mm. The holder consists of a support element screwed to the side of the enclosure and a leading element to which the vertical support, side, top and bottom additional covers are screwed.
- It is also possible to mount the rear WP-T brackets on additional CR-A elements.
- In each UW-BCR set there are two handles with leading elements and a set of self-tapping screws, screws and washers necessary for assembly in the enclosure.
- For enclosure with a height of 12 (1800 mm) and 13 (1950 mm), 6 handles (3 sets of UW-BCR) should be used.

CR-A leading element

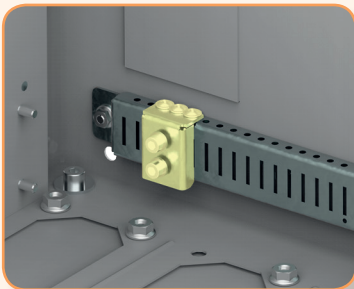

- The CR-A leading element enables the installation of WP-T vertical supports, WD-K vertical supports or PM-G mounting plates on the UW-BCR internal set holder. Thanks to the special design of the handle and the connecting element, it is possible to adjust the installation depth by 10 mm.
- The CR-A element does not have the possibility of screwing the enclosures.
- The CR-A element is sold in sets of two pieces with a set of self-tapping screws, bolts and washers necessary for assembly.
- Depending on the height of the selected WP vertical support, 2 or 3 sets of CR-A should be used.

Vertical division of the internal set

- An important advantage of the SOLID GSX system is the possibility of dividing the enclosure vertically using the EP W, EP-A, UW-SEP elements and WP-A and WP-T vertical supports. As a result, a electrical equipment, a cable or a teletechnical section can be separated in one enclosure.
- In HXS standing enclosures it is also possible to mount an additional, rear internal set intended for example for distribution of power supply with busbars.
- It is not possible to divide the enclosure by using the WP-U vertical support (economical version without the possibility of adjusting the depth of TH-S rails, PM mounting plates and the possibility of dividing the enclosure into sections).

EP-W dividing element

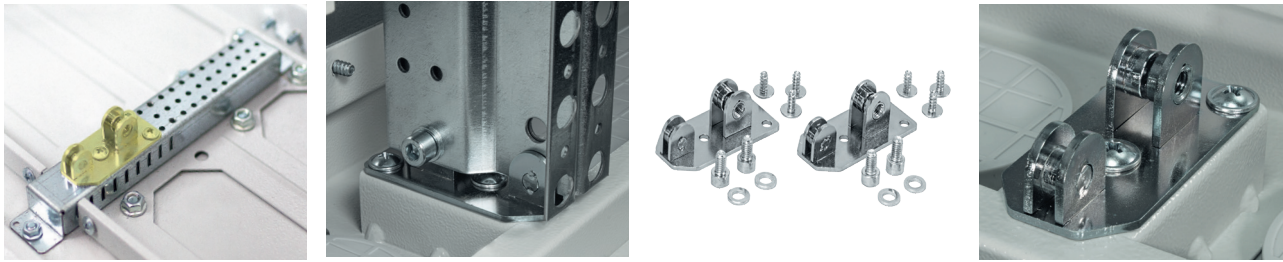

- EP-W dividing element is designed for 4XN160, 4XP160 and HXS standing enclosures (after using an additional UW-SEP support element). Thanks to a special design, it facilitates the assembly and disassembly of the internal set with the division on WP-A vertical supports (on the basis of a cradle).
- The EP-W dividing element is sold in sets of two pieces with a set of screws, washers and sheet metal screws.
- The EP-W SET includes: 2 divisional elements, 6 self-tapping screws, 4 M6x10 allen screws and 4 washers.

EP-A dividing element

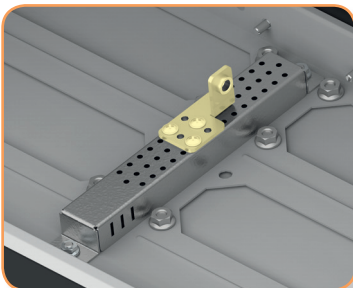

- The EP-A mounting element, like the EP-W, allows the internal set to be divided. Its simplified design will not facilitate the insertion of the internal set on the basis of a cradle, however, thanks to this element the WP-T rear vertical supports can be mounted in standing enclosures.
- The EP-A dividing element is sold in sets of two pieces with a set of screws, washers and sheet metal screws.
- The EP-A SET contains: 2 divisional elements, 6 self-tapping screws, 2 M8 Allen screws and 2 washers.

UW-SEP dividing support

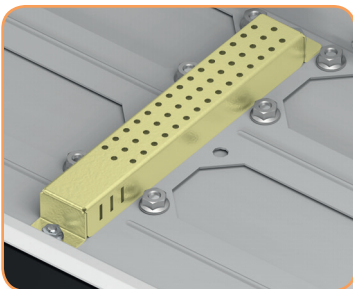

- The UW-SEP support provides functionality for the division of the internal set in HXS standing enclosures.
- After installing UW-SEP in the enclosure, you can use standard EP-W dividing sets, in addition, thanks to a special design, it allows you to adjust the depth of assembly of the entire internal set with equipment. UW-SEP dividing support is sold individually with two M6 nuts and one horizontal connector.

Horizontal division of the internal set

- Horizontal division of the internal set opens new possibilities in the design of the elevation and the arrangement of the equipment in the SOLID GSX enclosures. The smallest height of the section that can be realized is 300 mm, which results from the height of the lowest WP-A vertical support available in the offer. The horizontal division can be duplicated and combined with the vertical division creating unique structures adapted to the most demanding projects.
- The division of the insert significantly facilitates the distribution of cabling and power supply and ensures orderly arrangement of the equipment in the switchgear.

BL-WP dividing bar



- The BL-WP bar allows to divide the internal set depending on the width and configuration into two or three columns. The BL-WP 2 with a width of 500 mm can divide the internal set into two columns of 250 mm. However, the BL-WP 3 bar with a width of 750 mm allows to divide into three columns (each 250 mm) or two columns (one 250 mm wide and the other 500 mm wide).
- When dividing the internal set, attention should be paid to the maintenance of correct insulation distances between the electrical equipment and the construction components, especially the distance to the BL-WP dividing bar. The bar can be turned over by 180° and assembled depending on needs from the top or bottom of the WP-A vertical support.
- The BL-WP divider bar is sold in sets with a supporting element (500 mm wide beam - 1 supporting element, 750 mm wide beam - 2 supporting elements) and with a set of screws, washers and sheet metal screws necessary to mount it in the enclosure.
- With simultaneous vertical and horizontal division of the 3 mm (750 mm) internal set, remember that the bottom section is divided into 2 + 1, 1 + 2 or 1 + 1 + 1 and need to provide at least one middle support point.
- Using the BL-WP 3 dividing bar without providing at least one division in the bottom section is not allowed.

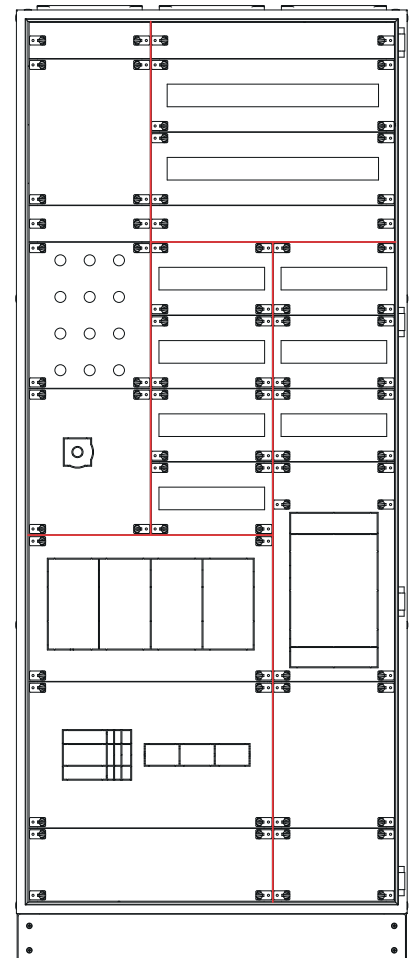
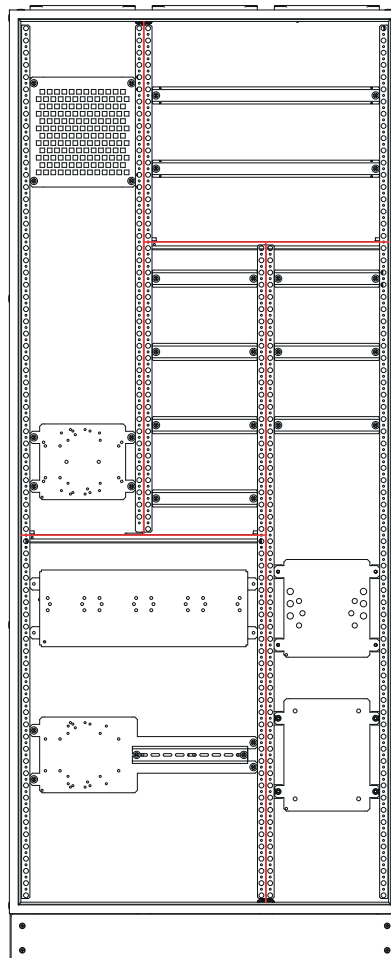
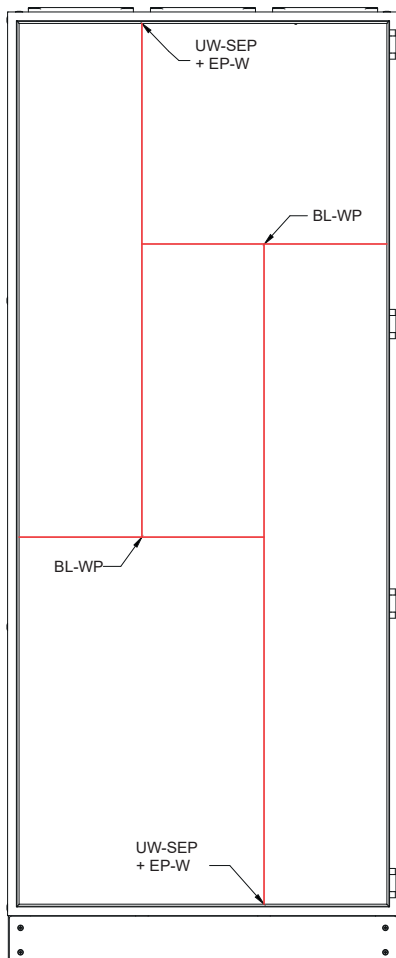

An example of the division of the internal set in the HXS enclosure

UA-B side handle

- The UA-B side bracket is used to attach the PM-G mounting plates or WD brackets directly to the rear wall of the enclosure. When using the UA-B bracket for WD vertical support, it should be remembered that the central fastening can cause a collision with the POP 100/185 insulation carrier, limiting the possibility of mounting the busbars at any height. In order to avoid collisions, a dedicated UA-B-WD bracket should be used.
- The UA-B bracket is mounted on the side edges of the enclosure (3 pcs on each side) on dedicated threaded pins.
- In order to mount a single PM-G mounting plate in the HXS enclosure on the back wall, where the width of the mounting plate is equal to the width of the enclosure mounting window (the simplest configuration), use 6 pieces of UA-B brackets (3 sets).
- UA-B side brackets are sold in sets of 2 pieces.

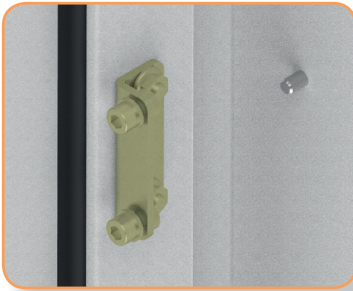
UA-B-WD side bracket for WD supports

- The UA-B-WD side bracket is used to attach the WD supports directly to the back of the enclosure.
- The UA-B-WD bracket is mounted on the side edges of the enclosure (3 pcs on each side) on dedicated threaded pins.
- To install a single WD support, use 3 pieces of UA-B-WD brackets.
- UA-B-WD side brackets are sold in sets of 2 pieces.

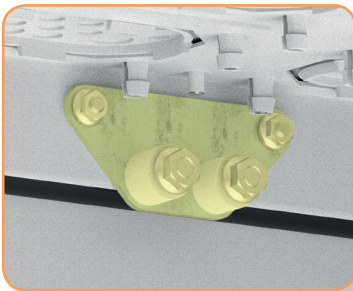
Central UA-S bracket

- The central bracket UA-S is used to attach WD brackets or PM-G mounting plates directly to the back of the enclosure (when the mounting plate width is smaller than the width of the enclosure mounting window).
- The UA-S bracket is mounted on the upper and lower edges of the enclosure on dedicated threaded pins.
- To install a single WD support, there is need to use 2 pcs of UA-S brackets. The number of brackets necessary to mount the PM-G mounting plates depends on the configuration, each bracket allows mounting of two adjacent mounting plates.
- UA-S middle brackets are sold in sets of 2 pieces.

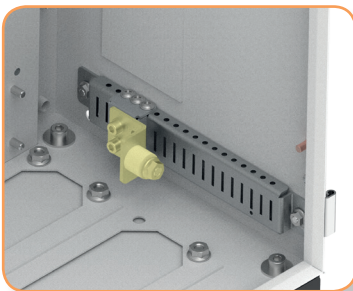
Side UR-B bracket (mounting depth adjustment)

- The UR-B side bracket is used for mounting the PM-G mounting plates ensuring the adjustment of the installation depth.
- The UR-B bracket is mounted on the internal set holders with UW-BCR adjustment.
- If the mounting plate is to be mounted behind an already existing mounting internal set, additional CR-A leading elements should be used.
- In order to mount a single PM-G in the HXS enclosure with the regulation of the installation depth, where the width of the mounting plate is equal to the width of the enclosure mounting window (the simplest configuration), 6 UR-B holders should be used.
- UR-B side brackets are sold in sets of 2 pieces.

Side UR-B-WD bracket for WD supports (mounting depth adjustment)

- The UR-B-WD side bracket is used for attaching WD supports, providing depth control of the mounting, while limiting the possibility of collision with the POP 100/185 insulation carrier.
- The UR-B-WD bracket is mounted on the internal set holders with UW-BCR adjustment.
- If the WD bracket is to be mounted behind an already existing mounting internal set, additional CR-A leading elements must be used.
- In order to mount a single WD bracket in the HXS enclosure with adjustable depth of the mounting, use 3 pcs of UR-B-WD brackets.
- UR-B-WD side brackets are sold in sets of 2 pieces.

UR-S center bracket

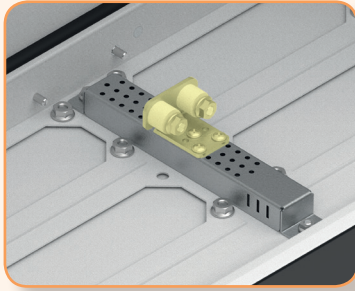

- The UR-S center bracket is used for attaching WD supports or PM-G mounting plates to ensure the installation depth adjustment (when the mounting plate width is smaller than the width of the enclosure mounting window).
- The UR-S bracket is mounted on the UW-SEP dividing bracket.
- In order to mount a single WD bracket, use 2 pcs of UR-S brackets. The number of brackets necessary to mount the PM-G mounting plates depends on the configuration, each bracket allows to mount two adjacent mounting plates.
- UR-S middle brackets are sold in sets of 2 pieces.

BL-UA and BL-UR stiffening bars



BL-UA



BL-UR

- Stiffening bars provide an additional support point for WD supports and PM-G mounting plates.
- Stiffening bars are available in the version to be mounted directly on the back wall of the enclosure (BL-UA) and in the version enabling the regulation of the depth of the installation (BL-UR).
- Depending on the application, the brackets for the PM-G mounting plate (BU-PM) or for the vertical support WD (BU-WD) should be purchased
- Stiffening bars are sold for 1 pc.

BU-PM bracket



BU-PM



BU-PM with mounting plate PM-G

- BU-PM brackets are designed for mounting PM-G mounting plates on a stiffening bar.
- Each BU-PM bracket provides one fulcrum for the PM-G mounting plate.
- BU-PM brackets are sold in sets of 2 pieces with a set of bolts and nuts necessary for their assembly on the stiffening bar and distances and nuts for screwing the PM-G mounting plate.

BU-WD bracket



BU-WD

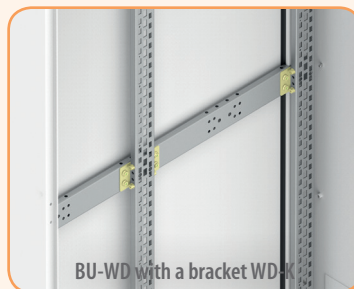

BU-WD with a bracket WD

- BU-WD brackets are dedicated for mounting WD vertical supports on a stiffening bar.
- Each BU-WD bracket is one point of support.
- BU-WD brackets are sold in sets of 2 pieces with a set of screws, nuts and washers necessary for mounting brackets on the stiffening bar and attaching WD supports.

LG-V fixing elements

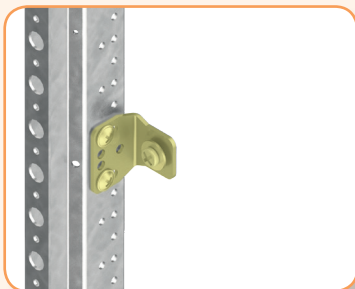

- The LG-V element is used for fixing TH-S rails and PM mounting plates to the WP-A vertical support. The fastening to the WP-A support takes place using two AST 4.8x9.5 self-tapping screws. The LG-V element has a metric M5 nut. TH-S rails and PM mounting plates are fastened to the LG-V element using M5 metric bolts (AS C 5x10) with AW-RE 5 washer.
- The LG-V element should be used for the assembly of TH-S rails intended for modular equipment, PM H00 M and PM K00 M mounting plates (for LTL00 / HVL00 / KVL00 switch disconnectors with modular equipment), PM ... E12 M (ED2 / EB2 125A, 160A, 250A disconnectors / circuit breakers with modular equipment), PM ... H00 and PM ... K00 (LTL00 / HVL00 / KVL00 switch disconnectors), PM..E12 L12 mounting plates (ED2 / EB2 125A, 160A, 250A disconnectors / circuit breakers).
- The assembly of TH-S rails is carried out using 2 LG-V (1 x LG-V SET set), PM mounting plates using 4 LG-V (2 x LG-V SET set).
- The LG-V element is packed: 50 pieces as a single element without self-tapping screws, metric bolts and washers or as a set (SET) consisting of 2 LG-V, 4 self-tapping screws, 2 washers and 2 M5 metric screws.

LG-V5 fixing elements

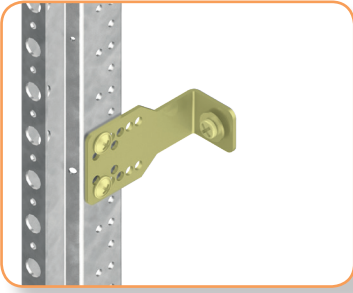

- The LG-V5 element is used for fixing TH-S rails and PM mounting plates to the WP-A vertical support. The fastening to the WP-A support takes place using two AST 4.8x9.5 self-tapping screws. The LG-V5 element has a metric M5 nut. TH-S rails and PM mounting plates are fixed to the LG-V5 element using M5 AS-C 5x10 metric screws with AW-RE 5 washer.
- The LG-V5 element allows you to place rails and mounting plates at a deeper depth than LG-V. The LG-V5 element should be used for mounting TH-S rails with terminal, PM ... E12 L12 mounting plates for LA1 (position 1) disconnectors, LA2 (positions 1 and 4) and for LBS 160 and 250 A disconnectors. Items shown in the instructions.
- TH-S rail mounting is done with 2 LG V5 (1 x LG-V5 SET set), PM mounting plates are mounting with 4 LG-V5 (2 x LG-V5 SET set).
- The LG-V5 element is packed: 20 pieces as a single element without self-tapping screws, metric bolts and washers or as a set (SET) consisting of 2 pieces LG-V5, 4 self-tapping screws, 2 washers and 2 M5 metric screws.

LG-V6-B fixing elements

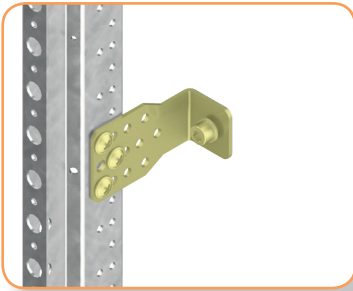

- The LG-V6-B element is used for fixing PM mounting plates with a higher load. The fixing to the WP-A support is done using two / three AST 4.8x9.5 self-tapping screws. In the element LG-V6-B there is a metric nut M6. PM mounting plates are fixed to the LG-V6-B element using M6x10 Allen screws (with washer). The LG-V6-B element allows assembly of devices with a larger mass than the LG-V5 bracket.
- The LG-V6-B element should be used for mounting PM mounting plates (before mounting, drill the mounting hole in PM plates with a Ø6 drill).
- LG-V6-B elements are sold only in sets of two pieces (SET) together with self-tapping screws, washers and screws necessary for assembly.

LG-V6-D fixing elements

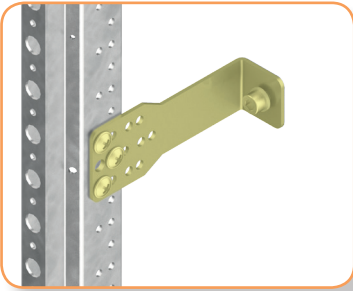

- The LG-V6-D element is a deeper equivalent of the B version, it is used for mounting PM mounting plates with a higher load. Similarly to other elements of LG-V, the fixing to the WP-A support takes place by means of two / three AST 4.8x9.5 self-tapping screws. The LG-V6-D element has an M6 metric nut. PM mounting plates are fixing to the LG-V6-D element using M6x10 Allen screws (with washer).
- The LG-V6-D element allows installation of devices with a larger mass than on the LG-V5 bracket and at a greater depth than LG-V6-B.
- The LG-V6-D element should be used for mounting PM mounting plates (before mounting, drill the mounting hole in PM plates with a Ø6 drill).
- Elements of LG-V6-D are sold only in sets of two pieces (SET) together with self-tapping screws, washers and screws necessary for assembly.

LG-V6R-B fixing elements

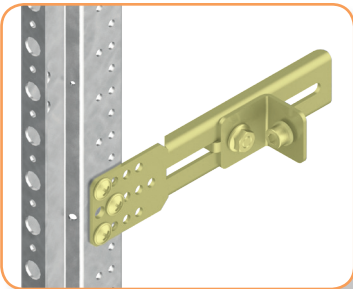

- The LG-V6R-B fixing element enables smooth adjustment of the mounting depth of TH-S rails or PM mounting plates. The fixing to the WP-A support is done using two / three AST 4.8x9.5 self-tapping screws.
- The LG-V6R-B element has an M6 metric nut.
- PM mounting plates are fixing to the LG-V element using M6x10 Allen screws (with washer).
- LG-V6R-B elements are sold only in sets of two pieces (SET) together with sheet metal screws, washers and screws necessary for assembly.

LG-T6-A fixing elements

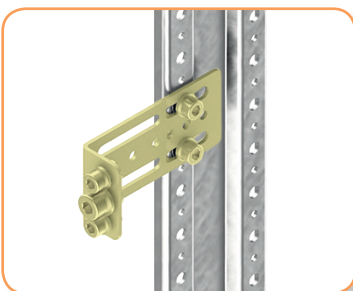

- The LG-T6-A fixing element, unlike the other elements from the LG-V group, is dedicated for mounting on WP-T back support.
- Thanks to the use of 2 mm thick metal sheet, this element can be used to mount equipment such as compact circuit breakers with motor drives.
- In the LG-T6-A element there are two metric nuts M6 and one M8 nut.
- PM mounting plates are fixed to the LG-T element using M6 allen screws or M8 (with washer).
- LG-T6-B elements are sold only in sets of two pieces (SET) together with washers and screws necessary for assembly.

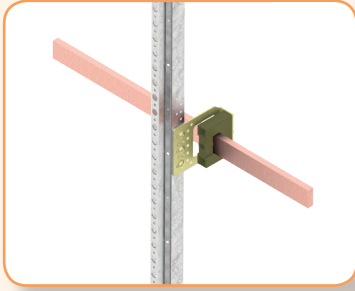
LG-B60-H P1 support

- Support with BBS insulating carrier for 1 busbar (width 30, 20, 25, 15, 12 mm and thickness 10, 6, 5 mm) mounted horizontally on WP-A / WP T supports.
- The construction of the support allows a step adjustment of the rail mounting depth.
- LG-B60-H P1 set is sold in sets, which includes: 1x metal support, 1x BBS insulating carrier for a single busbar and a set of screws and self-tapping screws necessary for mounting on the WP-A support.

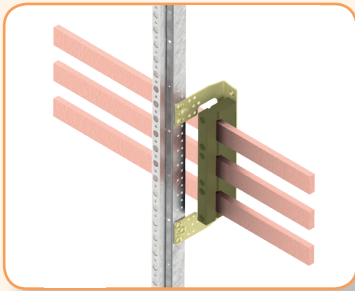
LG-B60-H P3 support

- Support with BBS insulating carrier for up to three busbars (30x10, 30x5, 20x10 or 20x5 mm) with 60 mm spacing, mounted horizontally on WP-A / WP T supports.
- The construction of the support allows for step adjustment of the rail mounting depth.
- Mounting depth of the support is suitable for installation on the busbar system such an equipment as KVL fuse switches in sizes NH00, 1, 2, 3.
- LG-B60-H P3 is sold in sets, which includes: 1x metal bracket, 1x BBS insulating carrier for 3 busbars and a set of screws and self-tapping screws necessary for mounting on the WP-A support.
- At the ends of the busbars, additional L-BBS-60/3 insulating covers should be used.
- If LG-B60-H P3 supports are installed in a position in which busbars or fixing elements are under a distance of less than 15 mm from WP-A / WP-T vertical supports or other metal parts of the construction of the internal set, additional L-WP-B60 / 3. insulating covers should be used.

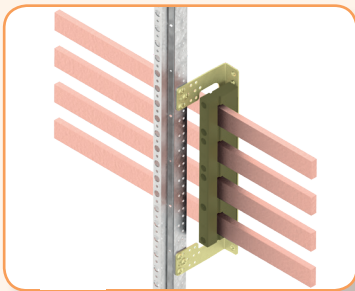
LG-B60-H P4 support

- Support with BBS insulating carrier for up to 4 busbars (30x10, 30x5, 20x10 or 20x5 mm) with a distance of 60 mm, mounted horizontally on WP-A / WP T supports.
- The construction of the support allows for step adjustment of the rail mounting depth.
- LG-B60-H P4 is sold in sets, which includes: 1x metal support, 1x BBS insulating carrier for 4 busbars and a set of screws and self-tapping screws necessary for mounting on the WP-A support.
- At the ends of the busbars, additional L-BBS-60/4 insulating covers should be used.
- If the LG-B60-H P4 supports are installed in a position in which busbars or fixing elements are under a distance of less than 15 mm from the WP-A / WP-T vertical supports or other metal parts of the internal set construction, additional insulating L-WP-B60 / 4 covers should be used .

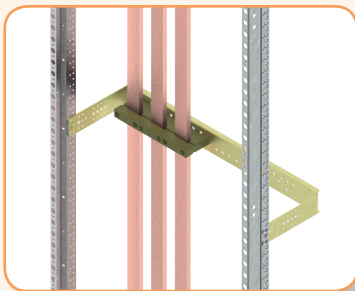
LG-B60-V2 P3 support

- Support with BBS insulating carrier for 3 busbars (30x10, 30x5, 20x10 or 20x5 mm) with 60 mm spacing mounted vertically, intended for mounting on WP-A / WP-T vertical supports .
- The construction of the support allows for step adjustment of the installation depth.
- The support is available for pole widths of 1 (250 mm) and 2 (500 mm).
- LG-B60-V2 P3 is sold in sets, which includes: 1x metal support, 1x BBS insulating carrier for 3 busbars and a set of screws, self-tapping screws and nuts necessary for mounting on WP-A supports.
- On a support with a width of 2 (500 mm) it is possible to mount an additional insulating carrier for 3 busbars.

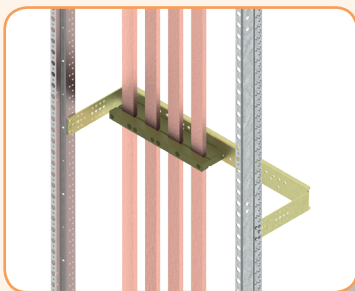
LG-B60-V2 P4 support

- Support with BBS insulating carrier for 4 busbars (30x10, 30x5, 20x10 or 20x5 mm) with 60 mm spacing mounted vertically, intended for mounting on WP-A / WP-T vertical supports.
- The construction of the support allows for step adjustment of the installation depth.
- The support is available for pole widths of 1 (250 mm) and 2 (500 mm).
- LG-B60-V2 P4 is sold in sets, which includes: 1x metal support, 1x BBS insulating carrier for 4 busbars and a set of screws, self-tapping screws and nuts necessary for mounting on WP-A supports.
- On a support with a width of 1 (250 mm) and 2 (500 mm) it is possible to install only one insulating carrier BBS-60/4 for 4 busbars.

Note: Support sets with insulation carriers LG-B60, UD-B60, LG-T-B185 and LG-T-INH are sold without busbars.

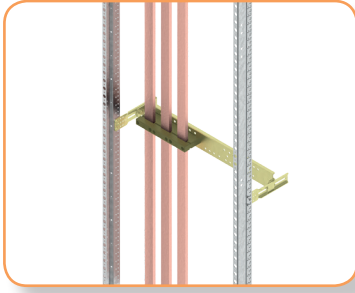
LG-B60-V2R P3 support

- Support with BBS insulating carrier for up to 3 busbars (30x10, 30x5, 20x10 or 20x5 mm) with 60 mm spacing mounted vertically with smooth adjustment of the mounting depth on WP-A / WP-T supports.
- The support is available for pole widths of 1 (250 mm) and 2 (500 mm).
- LG-B60-V2R P3 is sold in sets, which includes: 1x metal support with handles for smooth regulation, 1x BBS insulating carrier for 3 rails and a set of screws, self-tapping screws and nuts necessary for mounting on WP-A supports.
- On a support with a width of 2 (500 mm) it is possible to mount an additional insulating carrier for 3 busbars.

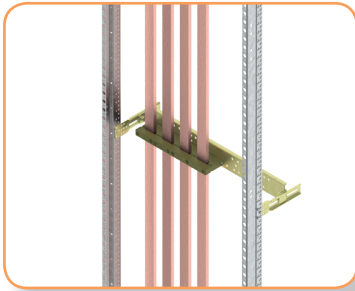
LG-B60-V2R P4 support

- Support with BBS insulating carrier for 4 busbars (30x10, 30x5, 20x10 or 20x5 mm) with 60 mm spacing mounted vertically with smooth adjustment of the mounting depth on WP-A / WP-T supports.
- The support is available for pole widths of 1 (250 mm) and 2 (500 mm).
- LG-B60-V2R P4 is sold in sets, which includes: 1x metal support with handles for smooth regulation, 1x BBS insulating carrier for 4 rails and a set of screws, self-tapping screws and nuts necessary for mounting on WP-A supports.
- On a support with a width of 1 (250 mm) and 2 (500 mm) it is possible to install only one insulating carrier BBS-60/4 for 4 busbars.

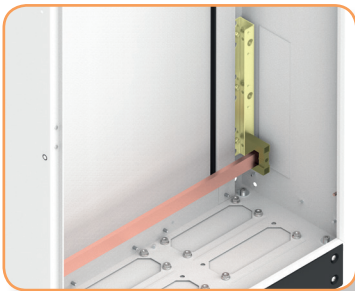
UD-B60-H P1 support

- Support with BBS insulating carrier for 1 busbar (width 30, 20, 25, 15, 12 mm and thickness 10, 6, 5 mm) designed for mounting directly to the body, on the back of the HXS enclosure.
- The support provides the possibility of carrying busbars between HXS enclosures (after breaking dedicated plugs in the enclosure body).
- The UD-B60-H P1 is sold in sets, consisting of: 1x metal support, 1x BBS insulating carrier for 1 busbar and a set of screws and nuts necessary for mounting directly to the body, on the back of the enclosure.
- The special construction allows the installation of two additional BBS-60/1 insulation carriers or one additional BBS 60/3 or BBS-60/4 carrier on the same support.

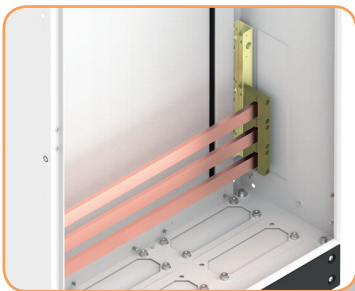
UD-B60-H P3 support

- Support with BBS insulating carrier for 3 busbars (30x10, 30x5, 20x10 or 20x5 mm) designed for mounting directly to the body, on the back of the HXS enclosure.
- The support provides the possibility of carrying busbars between HXS enclosures (after breaking dedicated plugs in the enclosure body)
- The UD-B60-H P3 is sold in sets, consisting of: 1x metal support, 1x BBS insulating carrier for 3 busbars and a set of screws and nuts necessary for mounting directly to the body, on the back of the enclosure.
- The special construction allows the installation of an additional BBS-60/1 insulation carrier on the same support.

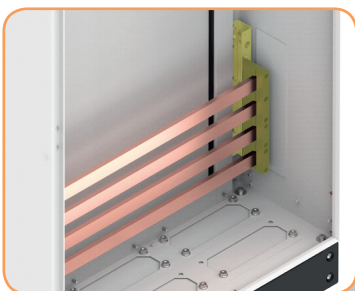
UD-B60-H P4 support

- Support with BBS insulating carrier for 4 busbars (30x10, 30x5, 20x10 or 20x5 mm) designed for mounting directly to the body, on the back of the HXS enclosure.
- The support provides the possibility of carrying busbars between HXS enclosures (after breaking dedicated plugs in the enclosure body)
- The UD-B60-H P4 is sold in sets, including: 1x metal support, 1x BBS insulating carrier for 4 busbars and a set of screws and nuts necessary for mounting directly to the body, on the back of the enclosure.
- The special construction allows the installation of an additional BBS-60/1 insulation carrier on the same support.

Note: Support sets with insulation carriers LG-B60, UD-B60, LG-T-B185 and LG-T-INH are sold without busbars.

Short-circuit withstand capability for selected distances between carriers (60 mm rail spacing)				
	The distance between the carriers (mm)	Impulse current withstand I _{pk} (kA)	Rated short-time withstand current I _{cw} (kA)	Dimension of busbars L1-L3 (mm)
3-pole				
a	200	75,6	36,8	30x5
	600	47,5	22,8	
b	200	54,6	26,3	20x5
	600	30,5	15,5	
c	200	75,6	37,9	30x10
	600	45,7	22,3	
d	200	61,0	29,0	20x10
	600	34,0	17,1	

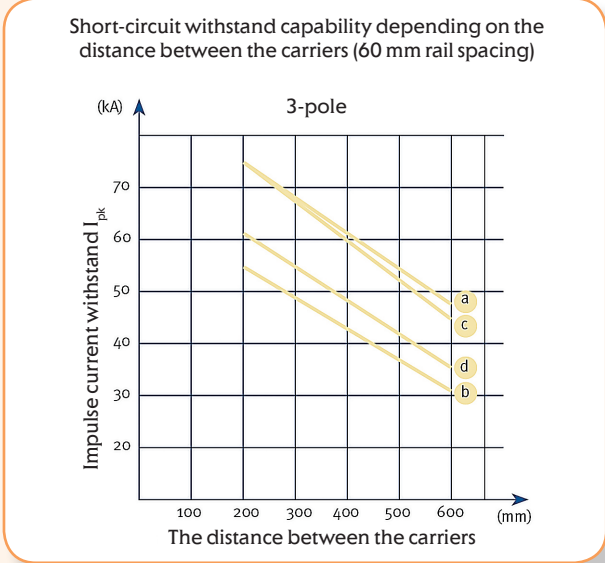

LG-T-B185-H P3 support

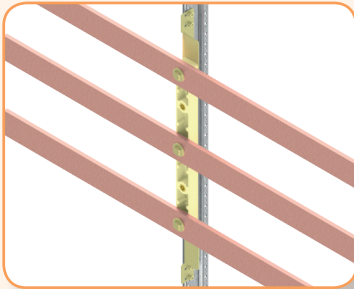

- Supports with POP 100 / 185 insulation carrier mounted horizontally on the WP-T support for 3 busbars (30x10, 40x10, 60x10, 80x10, 100x10 mm) with a distance of 100 or 185 mm.
- The special design of the LG-T-B185-H P3 support allows for step adjustment of the installation depth of the entire busbar system.
- The LG-T-B185-H P3 is sold in sets, consisting of: 1 x metal support, 1 x POP 100 / 185 insulating carrier and a set of screws, nuts and washers necessary for mounting on the WP-T support and screwing of the busbars (3 x M10 screw with washer).
- When LG-T-B185-H P3 supports are installed in a position where busbars or fixing elements are under a distance of less than 15 mm from WP A / WP-T vertical supports or other metal parts of the construction of the internal set, additional ZP POP-WP insulating covers need to be used.

Short-circuit withstand depending on the distance between the carriers (rail gauge 100 mm)

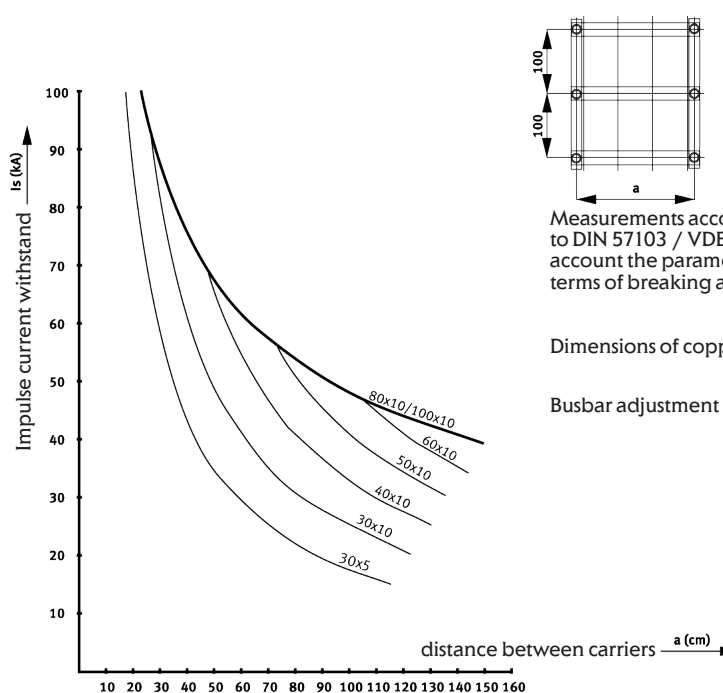

Note: Support sets with insulation carriers LG-B60, UD-B60, LG-T-B185 and LG-T-INH are sold without busbars.

Short-circuit withstand depending on the distance between the carriers (rail gauge 185 mm)

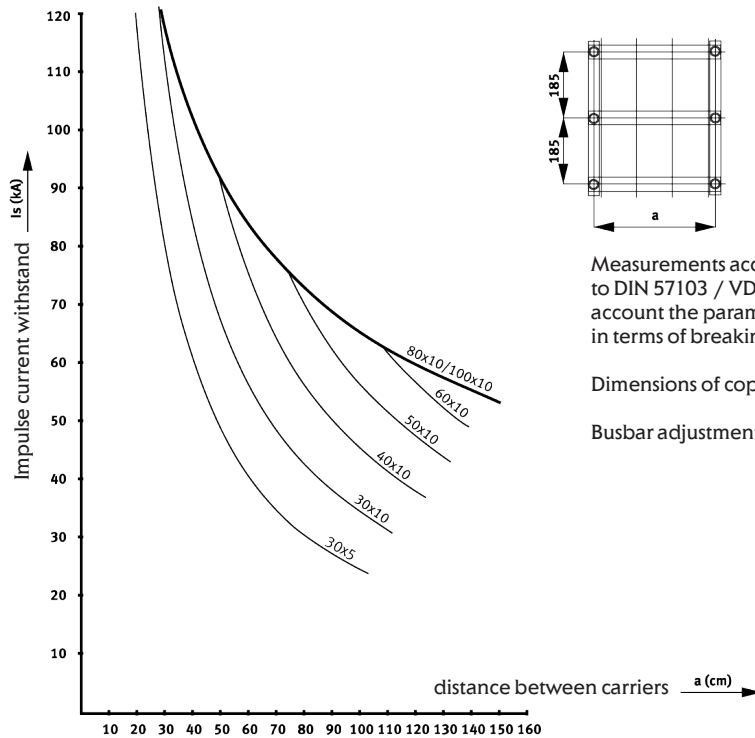

LG-T-INH1-A support with insulator

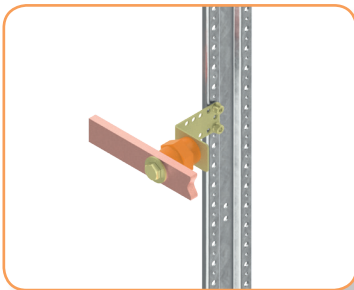

- The support with the INS insulator allows the installation of busbars (30x10 mm) on vertical WP-T supports .
- LG-T-INH1 -A support with insulator is sold in sets, consisting of: 1 x metal support, 1 x INS insulator and a set of screws, nuts and washers necessary for mounting on the WP-T support and fixing the busbar.
- When LG-T-INH1 -A supports are installed in a position where busbars or fixing elements are under a distance of less than 15 mm from WP A / WP-T vertical supports or other metal parts of the construction of the internal set, additional ZP POP-WP insulating covers should be used.



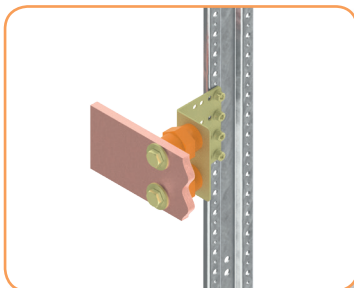







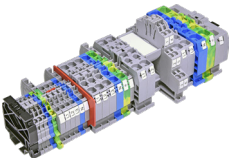



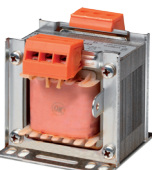





LG-T-INH2-A support with insulator

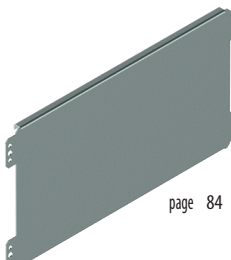





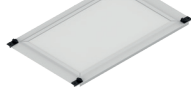
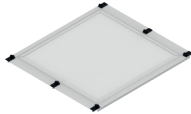
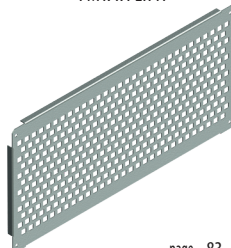

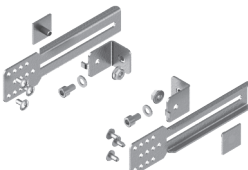











































- The support with the INS insulator allows the installation of busbars (80x10, 100x10 mm) on WP-T vertical supports .
- LG-T-INH2-A support with insulators is sold in sets, which include: 1 x metal support, 2x INS insulator and a set of screws, nuts and washers necessary for mounting on the WP-T support and fixing the busbars.
- When LG-T-INH2-A support are installed in a position where busbars or fixing elements are under a distance of less than 15 mm from WP A / WP-T vertical supports or other metal parts of the construction of the internal set, additional insulating ZP POP-WP covers should be used .

Note: Support sets with insulation carriers LG-B60, UD-B60, LG-T-B185 and LG-T-INH are sold without busbars.

Selection table for covers, mounting plates, TH-S rails and fixing elements

Type of equipment			Mounting plate	Fixing element
<p>Terminals type VS</p> <p>Large power contactors</p> <p>Busbars</p> <p>Safety and separation transformers</p> <p>Reserve space</p> <p>Completion the front of the enclosure</p>	    	<p>CP x-x F</p>       <p>page 72</p>	<p>TH-S x</p>  <p>page 80</p> <p>PM-F x-24</p>  <p>page 84</p>	<p>LG-V SET</p>  <p>page 91</p> <p>LG-V5 SET</p>  <p>page 91</p> <p>LG-V6-B SET</p>  <p>page 91</p>
<p>Non-standard equipment</p>	  	<p>CP x-2 PF</p>  <p>CP x-3 PF</p>  <p>page 73</p>	<p>PM x-x PER-A</p>  <p>page 83</p>	<p>LG-V6-D SET</p>  <p>page 91</p> <p>LG-V6R-B</p>  <p>page 91</p>















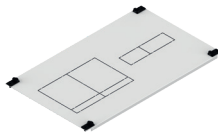
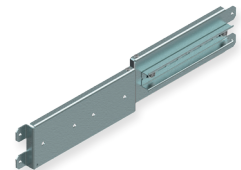

Selection table for covers, mounting plates, TH-S rails and fixing elements

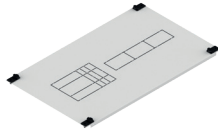
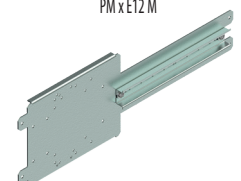
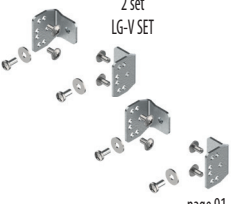
1 (250 mm)	1.4 (350 mm)	2 (500 mm)	2.2 (550 mm)	3 (750 mm)	3.8 (950 mm)	Fixing element
 CP 1-0.33 F 001101420	 CP 1.4-0.33 F 001101421		 CP 2.2-0.33 F 001101422	 CP 3-0.33 F 001101423	 CP 3.8-0.33 F 001101424	0.33 (50 mm)
 CP 1-0.5 F 001101425		 CP 2-0.5 F 001101426		 CP 3-0.5 F 001101427		0.5 (75 mm)
 CP 1-1 F 001101429	 CP 1.4-1 F 001101430	 CP 2-1 F 001101431	 CP 2.2-1 F 001101432	 CP 3-1 F 001101433	 CP 3.8-1 F 001101434	1 (150 mm)
 CP 1-2 F 001101436	 CP 1.4-2 F 001101437	 CP 2-2 F 001101438	 CP 2.2-2 F 001101439	 CP 3-2 F 001101440	 CP 3.8-2 F 001101441	2 (300 mm)
 CP 1-3 F 001101443		 CP 2-3 F 001101444		 CP 3-3 F 001101445		3 (450 mm)
 CP 1-4 F 001101447		 CP 2-4 F 001101448		 CP 3-4 F 001101449		4 (600 mm)
 CP 1-2 PF 001340050	 CP 1.4-2 PF 001340051	 CP 2-2 PF 001340052	 CP 2.2-2 PF 001340053	 CP 3-2 PF 001340054		2 (300 mm)
 CP 1-3 PF 001340056	 CP 1.4-3 PF 001340057	 CP 2-3 PF 001340058	 CP 2.2-3 PF 001340059	 CP 3-3 PF 001340060		3 (450 mm)
 TH-S 1 002911040	 TH-S 1.4 002911041	 TH-S 2 002911042	 TH-S 2.2 002911043	 TH-S 3 002911044	 TH-S 3.8 002911045	
 PM-F 1-24 001341000	 PM-F 1.4-24 001341001	 PM-F 2-24 001341002	 PM-F 2.2-24 001341003	 PM-F 3-24 001341004		
 PM 1-2 PER-A 001101621		 PM 2-2 PER-A 001101625		 PM 3-2 PER-A 001101629		

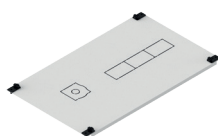

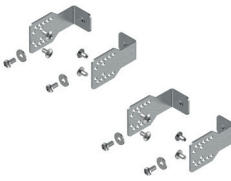

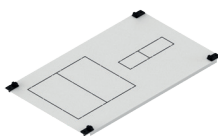



















































* full range of perforated PM x-x PER-A mounting plates on page 83

ETIBOX







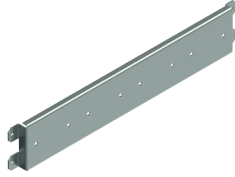
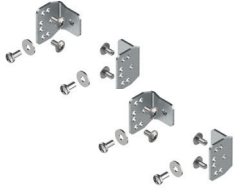

Selection table for covers, mounting plates, TH-S rails and fixing elements

Type of equipment	Cover	Mounting plate	Fixing element
<p>Modular equipment (up to 125 A)</p> 	<p>CP x-1 M</p>  <p>CP x-1.5 M</p>  <p>page 73</p>	<p>TH-S x</p>  <p>page 80</p>	<p>1 set LG-V SET</p>  <p>page 91</p>
<p>HVL EK fuse-switch disconnectors with size NH00 (up to 160 A) with modular equipment (up to 125 A)</p> 	<p>CP x-2 H00 M</p>  <p>page 74</p>	<p>PM x H00 M</p>  <p>page 80</p>	<p>2 set LG-V SET</p>  <p>page 91</p>
<p>ED2 / EB2 disconnectors / circuit breakers (up to 250 A) with modular equipment (up to 125 A)</p> 	<p>CP x-2 E12 M</p>  <p>page 74</p>	<p>PM x E12 M</p> 	<p>2 set LG-V SET</p>  <p>page 91</p>
<p>LBS1 type breakers (160 A) with modular equipment (up to 125 A)</p> 	<p>CP x-2 S1 M</p>  <p>page 75</p>	<p>PM x K00</p>  <p>page 81</p>	<p>2 set LG-V5 SET</p>  <p>page 91</p>
<p>KVL fuse-switch disconnectors with size NH00 (up to 160 A) with modular equipment (up to 125 A)</p> 	<p>CP x-2 K00</p>  <p>page 74</p>	<p>PM x K00</p>  <p>page 80</p>	<p>2 set LG-V SET</p>  <p>page 91</p>

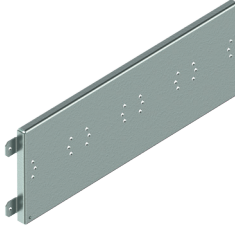

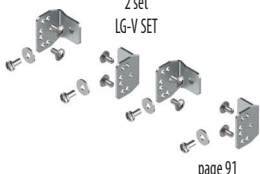

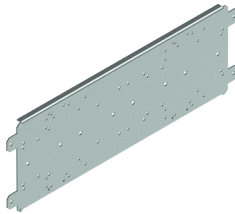
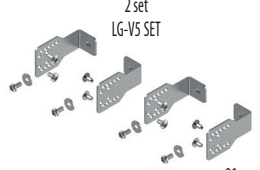









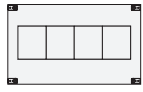

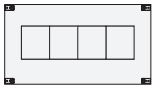

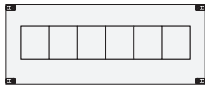

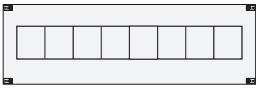





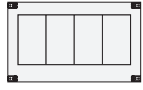
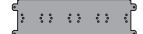
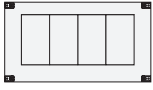
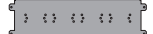
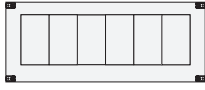
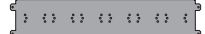







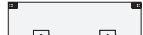
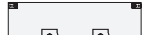

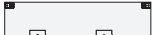

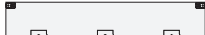

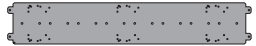





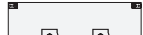



Selection table for covers, mounting plates, TH-S rails and fixing elements

1 (250mm)	1.4 (350mm)	2 (500mm)	2.2 (550mm)	3 (750mm)	3.8 (950mm)	Fixing element	
<p>12 mod.</p>  <p>CP 1-1 M 001101451</p>  <p>CP 1-1.5 M 001101458</p>  <p>TH-S 1 002911040</p>	<p>17 mod.</p>  <p>CP 1.4-1 M 001101452</p>  <p>CP 1-1.5 M 001101458</p>  <p>TH-S 1.4 002911041</p>	<p>24 mod.</p>  <p>CP 2-1 M 001101453</p>  <p>CP 2-1.5 M 001101459</p>  <p>TH-S 2 002911042</p>	<p>26 mod.</p>  <p>CP 2.2-1 M 001101454</p>  <p>CP 2-1.5 M 001101459</p>  <p>TH-S 2.2 002911043</p>	<p>36 mod.</p>  <p>CP 3-1 M 001101455</p>  <p>CP 3-1.5 M 001101460</p>  <p>TH-S 3 002911044</p>	<p>46 mod.</p>  <p>CP 3.8-1 M 001101456</p>  <p>CP 3-1.5 M 001101460</p>  <p>TH-S 3.8 002911045</p>	<p>1 set LG-V SET 001101683</p>	<p>1 (150mm)</p>
<p>1xHVL EK 00 NH00 4 mod.</p>  <p>CP 1-2 H00 M 001101474</p>  <p>PM 1 H00 M 001101563</p>	<p>1xHVL EK 00 NH00 5 mod.</p>  <p>CP 1.4-2 H00 M 001101475</p>  <p>PM 1.4 H00 M 001101564</p>	<p>2xHVL EK 00 NH00 9 mod.</p>  <p>CP 2-2 H00 M 001101476</p>  <p>PM 2 H00 M 001101565</p>	<p>2XHVL EK 00 NH00 10 mod.</p>  <p>CP 2.2-2 H00 M 001101477</p>  <p>PM 2.2 H00 M 001101566</p>	<p>3xHVL EK 00 NH00 16 mod.</p>  <p>CP 3-2 H00 M 001101478</p>  <p>PM 3 H00 M 001101567</p>	<p>4xHVL EK 00 NH00 21 mod.</p>  <p>CP 3.8-2 H00 M 001101479</p>  <p>PM 3.8 H00 M 001101568</p>	<p>2 set LG-V SET 001101683</p>	<p>2 (300mm)</p>
<p>1xEB2/ED2 3p do 250 A 4 mod.</p>  <p>CP 1-2 E12 M 3p 001101481</p>  <p>PM 1 E12 M 3P 001101570</p>	<p>1xEB2/ED2 3,4p do 250 A 4 mod.</p>  <p>CP 1.4-2 E12 M 001101482</p> <p>1xLBS1 3,4p 160 A 4 mod.</p>  <p>CP 1.4-2 S1 M 001101720</p>  <p>PM 1.4 E12 M 001101571</p>	<p>1xEB2/ED2 3,4p do 250 A 12 mod.</p>  <p>CP 2-2 E12 M 001101483</p> <p>1xLBS1 3,4p 160 A 12 mod.</p>  <p>CP 2-2 S1 M 001101721</p>  <p>PM 2 E12 M 001101572</p>	<p>1xEB2/ED2 3,4p do 250 A 14 mod.</p>  <p>CP 2.2-2 E12 M 001101484</p> <p>1xLBS1 3,4p 160 A 14 mod.</p>  <p>CP 2.2-2 S1 M 001101722</p>  <p>PM 2.2 E12 M 001101573</p>	<p>1xEB2/ED2 3,4p do 250 A 25 mod.</p>  <p>CP 3-2 E12 M 001101485</p> <p>1xLBS1 3,4p 160 A 25 mod.</p>  <p>CP 3-2 S1 M 001101723</p>  <p>PM 3 E12 M 001101574</p>	<p>1xEB2/ED2 3,4p do 250 A 36 mod.</p>  <p>CP 3.8-2 E12 M 001101486</p>  <p>PM 3.8 E12 M 001101575</p>	<p>2 set LG-V SET 001101683</p>	<p>2 (300mm)</p>
<p>1xKVL NH00 4 mod.</p>  <p>CP 1-2 K00 M 001339450</p>  <p>PM 1 K00 M 001340500</p>	<p>1xKVL NH00 5 mod.</p>  <p>CP 1.4-2 K00 M 001339451</p>  <p>PM 1.4 K00 M 001340501</p>	<p>2xKVL NH00 9 mod.</p>  <p>CP 2-2 K00 M 001339452</p>  <p>PM 2 K00 M 001340502</p>	<p>2xKVL NH00 10 mod.</p>  <p>CP 2.2-2 K00 M 001339453</p>  <p>PM 2.2 K00 M 001340503</p>	<p>3xKVL NH00 16 mod.</p>  <p>CP 3-2 K00 M 001339454</p>  <p>PM 3 K00 M 001340504</p>		<p>2 set LG-V SET 001101683</p>	<p>2 (300mm)</p>

Selection table for covers, mounting plates, TH-S rails and fixing elements

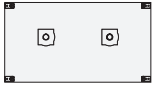







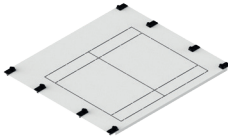
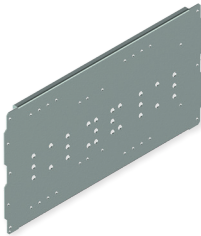
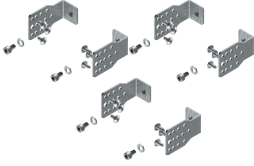

Type of equipment	Cover	Mounting plate	Fixing element
HVL EK fuse-switch disconnectors with size NH00 (up to 160 A)	 <p>CP x-2 H00</p> <p>page 75</p>	 <p>PM x H00</p> <p>page 81</p>	 <p>2 set LG-V SET</p> <p>page 91</p>
KVL fuse-switch disconnectors with size NH00 (up to 160 A)	 <p>CP x-2 H00</p> <p>page 75</p>	 <p>PM x H00</p> <p>page 82</p>	 <p>2 set LG-V SET</p> <p>page 91</p>
ED2 / EB2 disconnectors / circuit breakers (up to 250 A)	 <p>CP x-2 E12</p>		 <p>2 set LG-V SET</p> <p>page 91</p>
LBS1 type disconnectors (160 A)	 <p>CP x-2 S1</p> <p>page 78</p>	 <p>PM1 x E12 L12</p> <p>page 82</p>	 <p>2 set LG-VS SET</p> <p>page 91</p>
LBS2 type disconnectors (250 A)	 <p>CP x-2 S1</p> <p>page 78</p>		 <p>2 set LG-VS SET</p> <p>page 91</p>

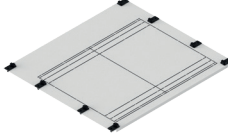
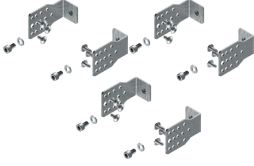
Selection table for covers, mounting plates, TH-S rails and fixing elements

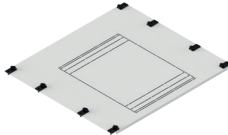
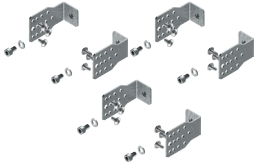

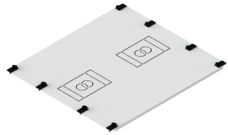
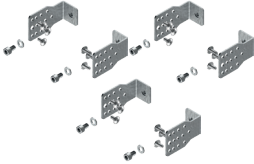
1 (250 mm)	1.4 (350 mm)	2 (500 mm)	2.2 (550 mm)	3 (750 mm)	3.8 (950 mm)	Fixing element	
<p>1xHVL EK 00 NH00</p>  <p>CP 1-2 H00 001101488</p>  <p>PM 1 H00 001101577</p>	<p>2xHVL EK 00 NH00</p>  <p>CP 1.4-2 H00 001101489</p>  <p>PM 1.4 H00 001101578</p>	<p>4xHVL EK 00 NH00</p>  <p>CP 2-2 H00 001101490</p>  <p>PM 2 H00 001101579</p>	<p>4xHVL EK 00 NH00</p>  <p>CP 2.2-2 H00 001101491</p>  <p>PM 2.2 H00 001101580</p>	<p>6xHVL EK 00 NH00</p>  <p>CP 3-2 H00 001101492</p>  <p>PM 3 H00 001101581</p>	<p>8xHVL EK 00 NH00</p>  <p>CP 3.8-2 H00 001101493</p>  <p>PM 3.8 H00 001101582</p>	<p>2 set LG-V SET 001101683</p>	<p>2 (300 mm)</p>
<p>1xKVL NH00</p>  <p>CP 1-2 K00 001339500</p>  <p>PM 1 K00 001340550</p>	<p>2xKVL NH00</p>  <p>CP 1.4-2 K00 001339501</p>  <p>PM 1.4 K00 001340551</p>	<p>4xKVL NH00</p>  <p>CP 2-2 K00 001339502</p>  <p>PM 2 K00 001340552</p>	<p>4xKVL NH00</p>  <p>CP 2.2-2 K00 001339503</p>  <p>PM 2.2 K00 001340553</p>	<p>6xKVL NH00</p>  <p>CP 3-2 K00 001339504</p>  <p>PM 3 K00 001340554</p>		<p>2 set LG-V SET 001101683</p>	<p>2 (300 mm)</p>
<p>1xEB2/ED2 3,4p do 250 A</p>  <p>CP 1-2 E12 001101514</p>  <p>CP 1-2 S1 001101725</p>  <p>PM 1 E12 L12 001101584</p>	<p>1xEB2/ED2 3,4p do 250 A</p>  <p>CP 1.4-2 E12 001101515</p>  <p>CP 1.4-2 S1 001101726</p>  <p>PM 1.4 E12 L12 001101585</p>	<p>2xEB2/ED2 3,4p do 250 A</p>  <p>CP 2-2 E12 001101516</p>  <p>CP 2-2 S1 001101727</p>  <p>PM 2 E12 L12 001101586</p>	<p>2xEB2/ED2 3,4p do 250 A</p>  <p>CP 2.2-2 E12 001101517</p>  <p>CP 2.2-2 S1 001101728</p>  <p>PM 2.2 E12 L12 001101587</p>	<p>3xEB2/ED2 3,4p do 250 A</p>  <p>CP 3-2 E12 001101518</p>  <p>CP 3-2 S1 001101729</p>  <p>PM 3 E12 L12 001101588</p>	<p>3xEB2/ED2 3,4p do 250 A</p>  <p>CP 3.8-2 E12 001101519</p>  <p>PM 3.8 E12 L12 001101589</p>	<p>2 set LG-V SET 001101683</p>	<p>2 (300 mm)</p>
<p>1xLBS1 3,4p 160 A</p>  <p>CP 1-2 S1 001101725</p>  <p>PM 1 E12 L12 001101584</p>	<p>1xLBS1 3,4p 160 A</p>  <p>CP 1.4-2 S1 001101726</p>  <p>PM 1.4 E12 L12 001101585</p>	<p>1xLBS1 3,4p 160 A</p>  <p>CP 2-2 S1 001101727</p>  <p>PM 2 E12 L12 001101586</p>	<p>1xLBS1 3,4p 160 A</p>  <p>CP 2.2-2 S1 001101728</p>  <p>PM 2.2 E12 L12 001101587</p>	<p>1xLBS1 3,4p 160 A</p>  <p>CP 3-2 S1 001101729</p>  <p>PM 3 E12 L12 001101588</p>		<p>2 set LG-V5 SET 001101685</p>	<p>2 (300 mm)</p>
<p>1xLBS2 3p 250 A</p>  <p>CP 1-2 S2 3P 001101731</p>  <p>PM 1 E12 L12 001101584</p>	<p>1xLBS2 3,4p 250 A</p>  <p>CP 1.4-2 S2 001101732</p>  <p>PM 1.4 E12 L12 001101585</p>	<p>2xLBS2 3p lub 1xLBS2 4p 250 A</p>  <p>CP 2-2 S2 001101733</p>  <p>PM 2 E12 L12 001101586</p>	<p>2xLBS2 3,4p 250 A</p>  <p>CP 2.2-2 S2 001101734</p>  <p>PM 2.2 E12 L12 001101587</p>	<p>3xLBS2 3p lub 2xLBS2 4p 250 A</p>  <p>CP 3-2 S2 001101735</p>  <p>PM 3 E12 L12 001101588</p>		<p>2 set LG-V5 SET 001101685</p>	<p>2 (300 mm)</p>

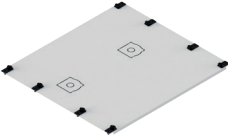
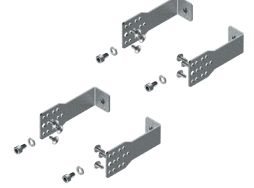
* depending on the assembly method of LA1 disconnectors, the use of LG V5 allows the LA1 disconnector to be completely hidden under the CP cover.

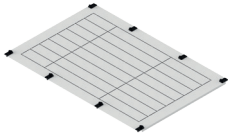
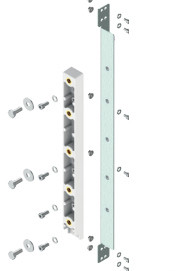
Selection table for covers, mounting plates, TH-S rails and fixing elements

Type of equipment	Cover	Mounting plate	Fixing element
KVL1 fuse-switch disconnectors with size NH1 (up to 250 A)	 <p>CP x-3 K1</p>  <p>page 76</p>	 <p>PM x ELS46 K123</p> <p>page 83</p>	<p>3 set LG-V6-B SET</p>  <p>page 91</p>
KVL1 fuse-switch disconnectors with size NH2 (up to 400 A)	 <p>CP x-3 K2</p>  <p>page 76</p>		<p>3 set LG-V6-B SET</p>  <p>page 91</p>
KVL1 fuse-switch disconnectors with size NH3 (up to 630 A)	 <p>CP x-3 K3</p>  <p>page 76</p>		<p>3 set LG-V6-B SET</p>  <p>page 91</p>
EB2 / ED2 disconnectors / circuit breakers (400, 630 A)	 <p>CP x-3 E46</p>  <p>page 77</p>		<p>3 set LG-V6-B SET</p> 
LBS 46 type disconnectors (400, 630 A)	 <p>CP x-3 S46</p>  <p>page 78</p>		<p>2 set LG-V6-D SET</p>  <p>page 91</p>
SL strip type fuse-switch disconnectors size NH00,1, 2, 3 (do 630 A)	 <p>CP x-5 SL</p>  <p>page 79</p>		<p>LG-T-B185-H P3</p>  <p>page 93</p>

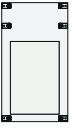
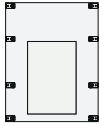
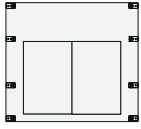
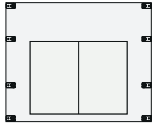
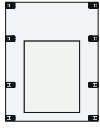
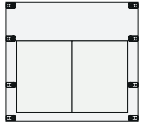
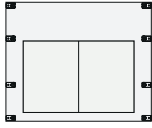
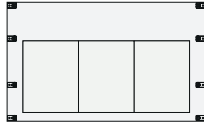
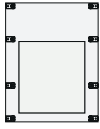
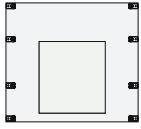
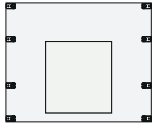
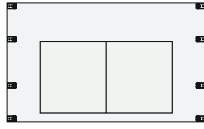
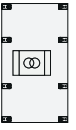
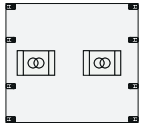
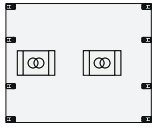
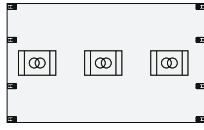
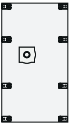
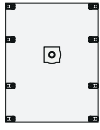
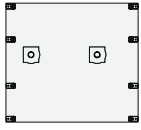
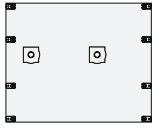
Selection table for covers, mounting plates, TH-S rails and fixing elements

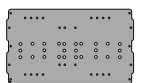
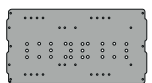
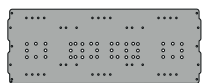
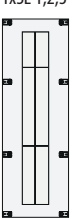
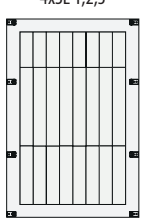
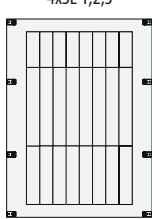
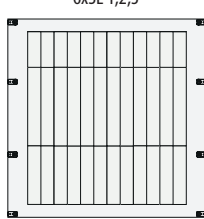
1 (250 mm)	1.4 (350 mm)	2 (500 mm)	2.2 (550 mm)	3 (750 mm)	3.8 (950 mm)	Fixing element	
<p>1xKVL1 NH1</p>  <p>CP 1-3 K1 001339550</p>	<p>1xKVL1 NH1</p>  <p>CP 1.4-3 K1 001339551</p>	<p>2xKVL1 NH1</p>  <p>CP 2-3 K1 001339552</p>	<p>2xKVL1 NH1</p>  <p>CP 2.2-3 K1 001339553</p>	<p>3xKVL1 NH1</p>  <p>CP 3-3 K1 001339554</p>		<p>3 set LG-V6-B SET 001341151</p>	<p>3 (450 mm)</p>
	<p>1xKVL2 NH2</p>  <p>CP 1.4-3 K2 001339600</p>	<p>2xKVL2 NH2</p>  <p>CP 2-3 K2 001339601</p>	<p>2xKVL2 NH2</p>  <p>CP 2.2-3 K2 001339602</p>	<p>3xKVL2 NH2</p>  <p>CP 3-3 K2 001339603</p>		<p>3 set LG-V6-B SET 001341151</p>	<p>3 (450 mm)</p>
	<p>1xKVL3 NH3</p>  <p>CP 1.4-3 K3 001339650</p>	<p>1xKVL3 NH3</p>  <p>CP 2-3 K3 001339651</p>	<p>1xKVL3 NH3</p>  <p>CP 2.2-3 K3 001339652</p>	<p>2xKVL3 NH3</p>  <p>CP 3-3 K3 001339653</p>		<p>3 set LG-V6-B SET 001341151</p>	<p>3 (450 mm)</p>
<p>1xEB2/ED2 3,4p do 630 A</p>  <p>CP 1-3 E46 001339300</p>	<p>1xEB2/ED2 3,4p do 630 A</p>  <p>CP 1.4-3 E46 001339301</p>	<p>2xEB2/ED2 3,4p do 630 A</p>  <p>CP 2-3 E46 001339302</p>	<p>2xEB2/ED2 3,4p do 630 A</p>  <p>CP 2.2-3 E46 001339303</p>	<p>3xEB2/ED2 3,4p do 630 A</p>  <p>CP 3-3 E46 001339304</p>		<p>3 set LG-V6-B SET 001341151</p>	<p>3 (450 mm)</p>
<p>1xLBS46 3p 400, 630 A</p>  <p>CP 1-3 S46 3P 001339700</p>	<p>1xLBS46 3,4p 400, 630 A</p>  <p>CP 1.4-3 S46 001339701</p>	<p>2xLBS46 3p or 1xLBS46 4p 400, 630 A</p>  <p>CP 2-3 S46 001339702</p>	<p>2xLBS46 3p or 1xLBS46 4p 400, 630 A</p>  <p>CP 2.2-3 S46 001339703</p>	<p>3xLBS46 3p or 1xLBS46 4p 400, 630 A</p>  <p>CP 3-3 S46 001339704</p>		<p>3 set LG-V6-D SET 001341153</p>	<p>3 (450 mm)</p>
<p>PM 1 ELS46 K1 001340700</p> 	<p>PM 1.4 ELS46 K123 001340701</p> 	<p>PM 2 ELS46 K123 001340702</p> 	<p>PM 2.2 ELS46 K123 001340703</p> 	<p>PM 3 ELS46 K123 001340704</p> 			
<p>2xSL 00 1xSL 1,2,3</p>  <p>CP 1-5 SL 001339750</p>	<p>4xSL 00 2xSL 1,2,3</p>  <p>CP 1.4-5 SL 001339751</p>	<p>8xSL 00 4xSL 1,2,3</p>  <p>CP 2-5 SL 001339752</p>	<p>8xSL 00 4xSL 1,2,3</p>  <p>CP 2.2-5 SL 001339753</p>	<p>12xSL 00 6xSL 1,2,3</p>  <p>CP 3-5 SL 001339754</p>		<p>LG-T-B185-H3 001341850</p>	<p>5 (750 mm)</p>

Plain metal covers



Plain covers - height 50 mm

Type	Description	Code nr	Weight (kg)	Packaging (pcs)
CP 1-0.33 F	Plain cover (250x50)	001101420	0,12	1
CP 1.4-0.33 F	Plain cover (350x50)	001101421	0,14	1
CP 2.2-0.33 F	Plain cover (550x50)	001101422	0,23	1
CP 3-0.33 F	Plain cover (750x50)	001101423	0,31	1
CP 3.8-0.33 F	Plain cover (950x50)	001101424	0,39	1

Assembly instructions: CP X-Y F



Plain covers - height 75 mm

Type	Description	Code nr	Weight (kg)	Packaging (pcs)
CP 1-0.5 F	Plain cover (250x75)	001101425	0,15	1
CP 2-0.5 F	Plain cover (500x75)	001101426	0,30	1
CP 3-0.5 F	Plain cover (750x75)	001101427	0,45	1

Assembly instructions: CP X-Y F

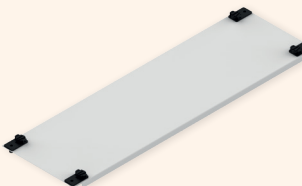

Plain covers - height 150 mm

Type	Description	Code nr	Weight (kg)	Packaging (pcs)
CP 1-1 F	Plain cover (250x150)	001101429	0,28	1
CP 1.4-1 F	Plain cover (350x150)	001101430	0,39	1
CP 2-1 F	Plain cover (500x150)	001101431	0,55	1
CP 2.2-1 F	Plain cover (550x150)	001101432	0,61	1
CP 3-1 F	Plain cover (750x150)	001101433	0,83	1
CP 3.8-1 F	Plain cover (950x150)	001101434	1,05	1

Assembly instructions: CP X-Y F



Plain covers - height 300 mm

Type	Description	Code nr	Weight (kg)	Packaging (pcs)
CP 1-2 F	Plain cover (250x300)	001101436	0,52	1
CP 1.4-2 F	Plain cover (350x300)	001101437	0,73	1
CP 2-2 F	Plain cover (500x300)	001101438	1,05	1
CP 2.2-2 F	Plain cover (550x300)	001101439	1,15	1
CP 3-2 F	Plain cover (750x300)	001101440	1,57	1
CP 3.8-2 F	Plain cover (950x300)	001101441	1,99	1

Assembly instructions: CP X-Y F

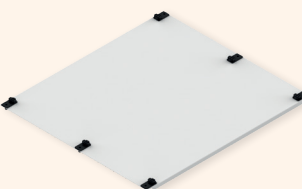

Plain covers - height 450 mm

Type	Description	Code nr	Weight (kg)	Packaging (pcs)
CP 1-3 F	Plain cover (250x450)	001101443	0,77	1
CP 2-3 F	Plain cover (500x450)	001101444	1,55	1
CP 3-3 F	Plain cover (750x450)	001101445	2,32	1

Assembly instructions: CP X-Y F



Plain covers - height 600 mm

Type	Description	Code nr	Weight (kg)	Packaging (pcs)
CP 1-4 F	Plain cover (250x600)	001101447	1,02	1
CP 2-4 F	Plain cover (500x600)	001101448	2,04	1
CP 3-4 F	Plain cover (750x600)	001101449	3,06	1

Assembly instructions: CP X-Y F

Universal covers with plastic filling



Universal covers with plastic filling for self-cutting - height 300 mm

Type	Description	Code nr	Weight (kg)	Packaging (pcs)
CP 1-2 PF	Universal cover with plastic filling (250x300)	001340050	0,41	1
CP 1.4-2 PF	Universal cover with plastic filling (350x300)	001340051	0,55	1
CP 2-2 PF	Universal cover with plastic filling (500x300)	001340052	0,84	1
CP 2.2-2 PF	Universal cover with plastic filling (550x300)	001340053	0,78	1
CP 3-2 PF	Universal cover with plastic filling (750x300)	001340054	1,01	1

Assembly instructions: CP X-Y PF

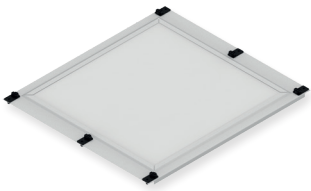

Universal covers with plastic filling for self-cutting - height 400 mm

Type	Description	Code nr	Weight (kg)	Packaging (pcs)
CP 1-3 PF	Universal cover with plastic filling (250x450)	001340056	0,63	1
CP 1.4-3 PF	Universal cover with plastic filling (350x450)	001340057	0,77	1
CP 2-3 PF	Universal cover with plastic filling (500x450)	001340058	0,99	1
CP 2.2-3 PF	Universal cover with plastic filling (550x450)	001340059	1,07	1
CP 3-3 PF	Universal cover with plastic filling (750x450)	001340060	1,36	1

Assembly instructions: CP X-Y PF

Modular equipment covers



Modular cover - height 150 mm

Type	Description	Code nr	Weight (kg)	Packaging (pcs)
CP 1-1 M	Modular cover 12 mod. (250x150)	001101451	0,21	1
CP 1.4-1 M	Modular cover 17 mod. (350x150)	001101452	0,29	1
CP 2-1 M	Modular cover 24 mod. (500x150)	001101453	0,42	1
CP 2.2-1 M	Modular cover 26 mod. (550x150)	001101454	0,46	1
CP 3-1 M	Modular cover 36 mod. (750x150)	001101455	0,63	1
CP 3.8-1 M	Modular cover 46 mod. (950x150)	001101456	0,79	1

Assembly instructions: CP X-1 M



Modular cover - height 225 mm

Type	Description	Code nr	Weight (kg)	Packaging (pcs)
CP 1-1.5 M	Modular cover 12 mod. (250x225)	001101458	0,33	1
CP 2-1.5 M	Modular cover 24 mod. (500x225)	001101459	0,67	1
CP 3-1.5 M	Modular cover 36 mod. (750x225)	001101460	1,00	1

Assembly instructions: CP X-1.5 M

Covers for HVL EK disconnectors and modular equipment

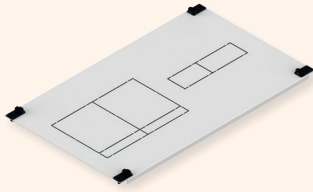

Covers for HVL EK 00 disconnectors and modular equipment - height 300 mm

Type	Description	Code nr	Weight (kg)	Packaging (pcs)
CP 1-2 H00 M	Cover 1xHVL EK 00 in 4 mod. (250x300)	001101474	0,52	1
CP 1.4-2 H00 M	Cover 1xHVL EK 00 in 5 mod. (350x300)	001101475	0,72	1
CP 2-2 H00 M	Cover 2xHVL EK 00 in 9 mod. (500x300)	001101476	1,03	1
CP 2.2-2 H00 M	Cover 2xHVL EK 00 in 10 mod. (550x300)	001101477	1,14	1
CP 3-2 H00 M	Cover 3xHVL EK 00 in 16 mod. (750x300)	001101478	1,55	1
CP 3.8-2 H00 M	Cover 4xHVL EK 00 in 21 mod. (950x300)	001101479	1,96	1

The covers should be completed with a dedicated PM H00 M mounting plate:
 Assembly instructions: CP X-2 H00 M

Note: HVL EK 00 disconnector covers available while stocks last.

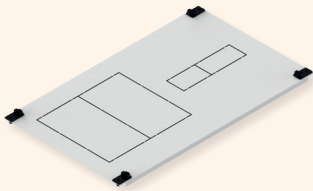

Covers for KVL00 disconnectors and modular equipment - height 300 mm

Type	Description	Code nr	Weight (kg)	Packaging (pcs)
CP 1-2 K00 M	Cover 1xKVL00 in 4 mod. (250x300)	001339450	0,48	1
CP 1.4-2 K00 M	Cover 1xKVL00 in 5 mod. (350x300)	001339451	0,68	1
CP 2-2 K00 M	Cover 2xKVL00 in 9 mod. (500x300)	001339452	1,06	1
CP 2.2-2 K00 M	Cover 2xKVL00 in 10 mod. (550x300)	001339453	1,07	1
CP 3-2 K00 M	Cover 3xKVL00 in 16 mod. (750x300)	001339454	1,58	1

The covers should be completed with a dedicated PM K00 M mounting plate
 Assembly instructions: CP X-2 K00 M

Covers for ED2 disconnectors / EB2 circuit breakers and modular equipment

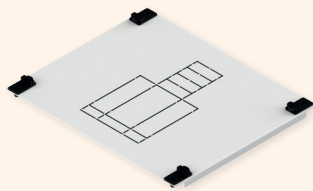

Cover for ED2 / EB2 125,160,250 3P disconnectors and circuit breakers and modular equipment - height 300 mm

Type	Description	Code nr	Weight (kg)	Packaging (pcs)
CP 1-2 E12 M 3P	Cover 1xEB2/ED2 125,160,250A 3P in 4 mod. (250x300)	001101481	0,51	1

The cover should be completed with a dedicated PM 1 E12 M 3P mounting plate:
 Assembly instructions: CP 1-2 E12 M 3P

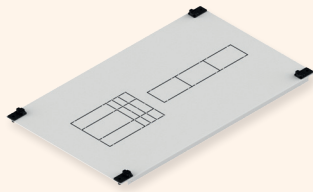

Cover for ED2 / EB2 125,160,250 4P disconnectors and circuit breakers and modular equipment - height 300 mm

Type	Description	Code nr	Weight (kg)	Packaging (pcs)
CP 1.4-2 E12 M	Cover 1xEB2/ED2 125,160,250A 3,4P in 4 mod. (350x300)	001101482	0,72	1
CP 2-2 E12 M	Cover 1xEB2/ED2 125,160,250A 3,4P in 12 mod. (500x300)	001101483	1,03	1
CP 2.2-2 E12 M	Cover 1xEB2/ED2 125,160,250A 3,4P in 14 mod. (550x300)	001101484	1,13	1
CP 3-2 E12 M	Cover 1xEB2/ED2 125,160,250A 3,4P in 25 mod. (750x300)	001101485	1,54	1
CP 3.8-2 E12 M	Cover 1xEB2/ED2 125,160,250A 3,4P in 36 mod. (950x300)	001101486	1,95	1

The covers should be completed with a dedicated PM E12 M mounting plate:
 Assembly instructions: CP X-2 E12 M

Covers for LBS disconnectors and modular equipment

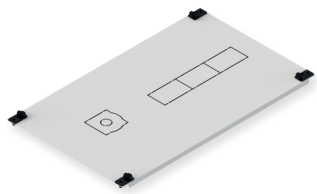

Covers for LBS disconnectors and modular equipment - height 300 mm

Type	Description	Code nr	Weight (kg)	Packaging (pcs)
CP 1.4-2 S1 M	Cover 1xLBS 160A 3,4P in 4 mod. (350x300)	001101720	0,72	1
CP 2-2 S1 M	Cover 1xLBS 160A 3,4P in 12 mod. (500x300)	001101721	1,03	1
CP 2.2-2 S1 M	Cover 1xLBS 160A 3,4P in 14 mod. (550x300)	001101722	1,13	1
CP 3-2 S1 M	Cover 1xLBS 160A 3,4P in 25 mod. (750x300)	001101723	1,55	1

The covers should be completed with a dedicated PM E12 M mounting plate:
Installation instructions: CP X-2 S1 M

Covers for HVL EK 00 fuse-switch disconnectors

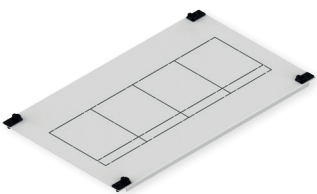

Covers for HVL EK 00 fuse-switch disconnectors - height 300 mm

Type	Description	Code nr	Weight (kg)	Packaging (pcs)
CP 1-2 H00	Cover 1xHVL EK 00 (250x300)	001101488	0,52	1
CP 1.4-2 H00	Cover 2xHVL EK 00 (350x300)	001101489	0,72	1
CP 2-2 H00	Cover 4xHVL EK 00 (500x300)	001101490	1,03	1
CP 2.2-2 H00	Cover 4xHVL EK 00 (550x300)	001101491	1,13	1
CP 3-2 H00	Cover 6xHVL EK 00 (750x300)	001101492	1,55	1
CP 3.8-2 H00	Cover 8xHVL EK 00 (950x300)	001101493	1,96	1

The covers should be completed with a dedicated PM H00 mounting plate
Assembly instructions: CP X-2 H00

Note: HVL EK 00 disconnector covers available while stocks last.

Covers for KVL 00 fuse-switch disconnectors

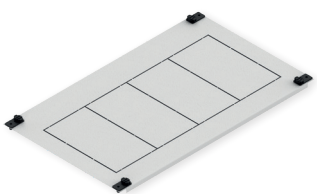

Covers for KVL 00 fuse-switch disconnectors - height 300 mm

Type	Description	Code nr	Weight (kg)	Packaging (pcs)
CP 1-2 K00	Cover 1xKVL00 (250x300)	001339500	0,53	1
CP 1.4-2 K00	Cover 2xKVL00 (350x300)	001339501	0,68	1
CP 2-2 K00	Cover 4xKVL00 (500x300)	001339502	1,07	1
CP 2.2-2 K00	Cover 4xKVL00 (550x300)	001339503	1,07	1
CP 3-2 K00	Cover 6xKVL00 (750x300)	001339504	1,58	1

The covers should be completed with a dedicated PM K00 mounting plate
Assembly instructions: CP X-2 K00

KVL fuse-switch disconnectors covers for sizes 1,2,3

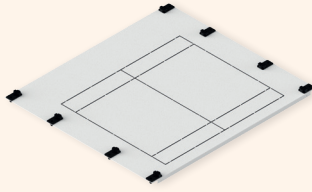

Covers for KVL 1 fuse-switch disconnectors - height 450 mm

Type	Description	Code nr	Weight (kg)	Packaging (pcs)
CP 1-3 K1	Cover 1xKVL1 (250x450)	001339550	0,70	1
CP 1.4-3 K1	Cover 1xKVL1 (350x450)	001339551	1,00	1
CP 2-3 K1	Cover 2xKVL1 (500x450)	001339552	1,79	1
CP 2.2-3 K1	Cover 2xKVL1 (550x450)	001339553	1,58	1
CP 3-3 K1	Cover 3xKVL1 (750x450)	001339554	2,33	1

The covers should be completed with a dedicated PM ... ELS46 K123 mounting plate:
 Assembly instructions: CP x-3 K1

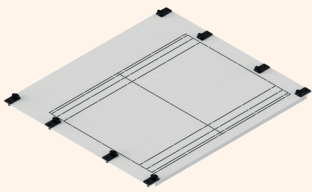

Covers for KVL 2 fuse-switch disconnectors - height 450 mm

Type	Description	Code nr	Weight (kg)	Packaging (pcs)
CP 1.4-3 K2	Cover 1xKVL2 (350x450)	001339600	0,99	1
CP 2-3 K2	Cover 2xKVL2 (500x450)	001339601	1,41	1
CP 2.2-3 K2	Cover 2xKVL2 (550x450)	001339602	1,55	1
CP 3-3 K2	Cover 3xKVL2 (750x450)	001339603	2,33	1

The covers should be completed with a dedicated PM ... ELS46 K123 mounting plate:
 Assembly instructions: CP x-3 K2

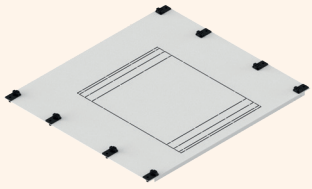

Covers for KVL 3 fuse-switch disconnectors - height 450 mm

Type	Description	Code nr	Weight (kg)	Packaging (pcs)
CP 1.4-3 K3	Cover 1xKVL3 (350x450)	001339650	0,99	1
CP 2-3 K3	Cover 1xKVL3 (500x450)	001339651	1,43	1
CP 2.2-3 K3	Cover 1xKVL3 (550x450)	001339652	1,57	1
CP 3-3 K3	Cover 2xKVL3 (750x450)	001339653	2,34	1

The covers should be completed with a dedicated PM ... ELS46 K123 mounting plate:
 Assembly instructions: CP x-3 K3

ED2 / EB2 (125, 160, 250 A) disconnectors and circuit breakers

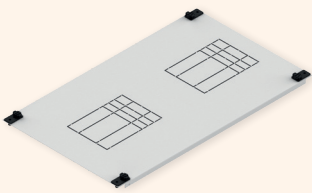

ED2 / EB2 125, 160, 250 A 3, 4P disconnectors and circuit breakers - height 300 mm

Type	Description	Code nr	Weight (kg)	Packaging (pcs)
CP 1-2 E12	Cover 1xEB2/ED2 125,160,250A 3,4P (250x300)	001101514	0,51	1
CP 1.4-2 E12	Cover 1xEB2/ED2 125,160,250A 3,4P (350x300)	001101515	0,72	1
CP 2-2 E12	Cover 2xEB2/ED2 125,160,250A 3,4P (500x300)	001101516	1,02	1
CP 2.2-2 E12	Cover 2xEB2/ED2 125,160,250A 3,4P (550x300)	001101517	1,13	1
CP 3-2 E12	Cover 3xEB2/ED2 125,160,250A 3,4P (750x300)	001101518	1,53	1
CP 3.8-2 E12	Cover 3xEB2/ED2 125,160,250A 3,4P (950x300)	001101519	1,95	1

The covers should be completed with a dedicated PM E12 L12 mounting plate:
 Assembly instructions: CP X-2 E12

ED2 / EB2 (400, 630 A) disconnectors and circuit breakers

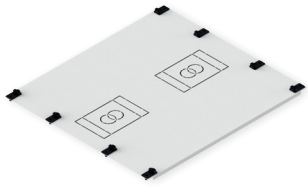

Covers for EB2 / ED2 400, 630 A 3,4P disconnectors and circuit breakers - height 450 mm

Type	Description	Code nr	Weight (kg)	Packaging (pcs)
CP 1-3 E46	Cover 1xEB2/ED2 400, 630A 3,4P (250x450)	001339300	0,72	1
CP 1.4-3 E46	Cover 1xEB2/ED2 400, 630A 3,4P (350x450)	001339301	1,01	1
CP 2-3 E46	Cover 2xEB2/ED2 400, 630A 3,4P (500x450)	001339302	1,44	1
CP 2.2-3 E46	Cover 2xEB2/ED2 400, 630A 3,4P (550x450)	001339303	1,58	1
CP 3-3 E46	Cover 3xEB2/ED2 400, 630A 3,4P (750x450)	001339304	2,35	1

The covers should be completed with a dedicated PM ... ELS46 K123 mounting plate
 Assembly instructions: CP X-3 E46

Covers for LBS1,2,3,4 (160-630 A) disconnectors

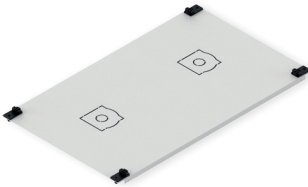

Covers for LBS 160 A disconnectors - height 300 mm

Type	Description	Code nr	Weight (kg)	Packaging (pcs)
CP 1-2 S1	Cover 1xLBS 160A 3,4P (250x300)	001101725	0,52	1
CP 1.4-2 S1	Cover 1xLBS 160A 3,4P (350x300)	001101726	0,73	1
CP 2-2 S1	Cover 2xLBS 160A 3,4P (500x300)	001101727	1,04	1
CP 2.2-2 S1	Cover 2xLBS 160A 3,4P (550x300)	001101728	1,15	1
CP 3-2 S1	Cover 3xLBS 160A 3,4P (750x300)	001101729	1,57	1

The covers should be completed with a dedicated PM E12 L12 mounting plate
 Assembly instructions: CP X-2 S1

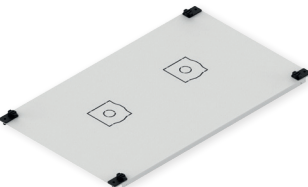

Covers for LBS 250 A disconnectors - height 300 mm

Type	Description	Code nr	Weight (kg)	Packaging (pcs)
CP 1-2 S2 3P	Cover 1xLBS 250A 3P (250x300)	001101731	0,52	1
CP 1.4-2 S2	Cover 1xLBS 250A 3,4P (350x300)	001101732	0,73	1
CP 2-2 S2	Cover 2xLBS 250A 3P lub 1xLBS 250A 4P (500x300)	001101733	1,04	1
CP 2.2-2 S2	Cover 2xLBS 250A 3,4P (550x300)	001101734	1,15	1
CP 3-2 S2	Cover 3xLBS 250A 3P lub 2xLBS 250A 4P (750x300)	001101735	1,57	1

The covers should be completed with a dedicated PM ... E12 L12 mounting plate
 Assembly instructions: CP X-2 S2

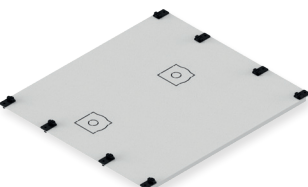

Covers for LBS 400, 630 A disconnectors - height 450 mm

Type	Description	Code nr	Weight (kg)	Packaging (pcs)
CP 1-3 S46 3P	Cover 1xLBS 400, 630A 3P (250x450)	001339700	0,72	1
CP 1.4-3 S46	Cover 1xLBS 400, 630A 3,4P (350x450)	001339701	1,02	1
CP 2-3 S46	Cover 2xLBS 400, 630A 3P lub 1xLBS 400, 630A 4P (500x450)	001339702	1,45	1
CP 2.2-3 S46	Cover 2xLBS 400, 630A 3P lub 1xLBS 400, 630A 4P (550x450)	001339703	1,60	1
CP 3-3 S46	Cover 3xLBS 400, 630A 3P lub 1xLBS 400, 630A 4P (750x450)	001339704	2,39	1

The covers should be completed with a dedicated PM ... ELS46 K123 mounting plate
 Assembly instructions: CP X-3 S46

Covers for SL strip type fuse-switch disconnectors SL00,1,2,3 (2-630 A)

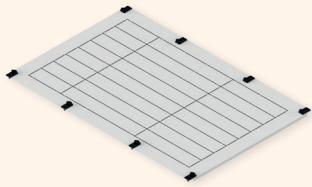

Covers for SL strip type fuse-switch disconnectors (20 - 630 A)

Type	Description	Code nr	Weight (kg)	Packaging (pcs)
CP 1-5 SL	Cover 2xSL00 lub 1xSL1,2,3 (250x750)	001339750	1,17	1
CP 1.4-5 SL	Cover 4xSL00 lub 2xSL1,2,3 (350x750)	001339751	1,63	1
CP 2-5 SL	Cover 8xSL00 lub 4xSL1,2,3 (500x750)	001339752	2,31	1
CP 2.2-5 SL	Cover 8xSL00 lub 4xSL1,2,3 (550x750)	001339753	2,55	1
CP 3-5 SL	Cover 12xSL00 lub 6xSL1,2,3 (750x750)	001339754	3,77	1

Assembly instructions: CP-X-5 SL

Additional covers to complement the front of the HXS enclosures



Side vertical additional covers

Type	Description	Code nr	Weight (kg)	Packaging (pcs)
CP-BV 12	Side additional covers, sleft and right, for HXS enclosures, height 12 (1800) (1kpl.)	001340164	0,99	1
CP-BV 13	Side additional covers, sleft and right, for HXS enclosures, height 13 (1950) (1kpl.)	001340165	1,09	1

The set includes: a set of side covers (left and right) for enclosures and a set of self-tapping screws
 Assembly instructions: CP-BV



Horizontal upper and lower additional covers - not separated

Type	Description	Code nr	Weight (kg)	Packaging (pcs)
CP-BHS 2	Horizontal, upper and lower horizontal additional covers, for HXS enclosures, width 2 (500) (1kpl.)	001340252	0,25	1
CP-BHS 3	Horizontal, upper and lower horizontal additional covers, for HXS enclosures, width 3 (750) (1kpl.)	001340254	0,37	1

The set includes: a pair of not separated additional covers (top and bottom) for enclosures with no internal division and a set of self-tapping screws.
 Assembly instructions: CP-BHS

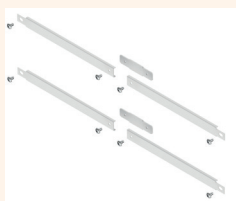

Horizontal upper and lower additional covers - divided

Type	Description	Code nr	Weight (kg)	Packaging (pcs)
CP-BH 2	Divided horizontal additional covers, top and bottom, for HXS enclosures, width 2 (500) (1 set)	001340200	0,29	1
CP-BH 3	Divided horizontal additional covers, top and bottom, for HXS enclosures, width 3 (750) (1 set)	001340201	0,43	1
CP-BH 4	Divided horizontal additional covers, top and bottom, for HXS enclosures, width 4 (1000) (1 set)	001340202	0,58	1

Includes: set of additional covers (upper and lower) divided with connecting elements for enclosures with an internal division of the internal set and a set of self-tapping screws
 Assembly instructions: CP-BH

TH mounting rails



TH mounting rails				
Type	Description	Code nr	Weight (kg)	Packaging (pcs)
TH-S 1	Mounting rail 35/15 1.5 steel 215 mm (250)	002911040	0,15	1
TH-S 1.4	Mounting rail 35/15 1.5 steel 315 mm (350)	002911041	0,21	1
TH-S 2	Mounting rail 35/15 1.5 steel 465 mm (500)	002911042	0,32	1
TH-S 2.2	Mounting rail 35/15 1.5 steel 515 mm (550)	002911043	0,35	1
TH-S 3	Mounting rail 35/15 1.5 steel 715 mm (750)	002911044	0,49	1
TH-S 3.8	Mounting rail 35/15 1.5 steel 915 mm (950)	002911045	0,62	1

Selection of the rail length depending on the width of the assembly pole.
 To mount TH-S rails on WP-A supports, depending on the required installation depth, use:
 1 x LG-V SET - modular equipment
 1 x LG-V5 SET - serial terminals
 To mount the TH-S rail on the LG-V6 fixing elements, drill the mounting holes with a Ø6 drill

Mounting plates for HVL EK 00 disconnectors and modular equipment

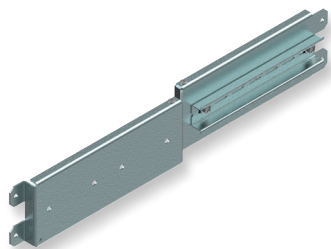

Mounting plates for HVL EK 00 disconnectors and modular equipment				
Type	Description	Code nr	Weight (kg)	Packaging (pcs)
PM 1 H00 M	Mounting plate 1xHVL EK 00 with TH35 rail for 4 mod. (250)	001101563	0,31	1
PM 1.4 H00 M	Mounting plate 1xHVL EK 00 with TH35 rail for 5 mod. (350)	001101564	0,53	1
PM 2 H00 M	Mounting plate 1xHVL EK 00 with TH35 rail for 9 mod. (500)	001101565	0,79	1
PM 2.2 H00 M	Mounting plate 1xHVL EK 00 with TH35 rail for 10 mod. (550)	001101566	0,88	1
PM 3 H00 M	Mounting plate 1xHVL EK 00 with TH35 rail for 16 mod. (750)	001101567	1,31	1
PM 3.8 H00 M	Mounting plate 1xHVL EK 00 with TH35 rail for 21 mod. (950)	001101568	1,57	1

To mount one piece of the HVL EK 00 disconnector on the mounting plate, you should purchase:
 • M6x16 DIN 933 screw (AS-H 6x16) - 2 pcs.
 • M6 washer DIN 126 (AW-R 6) - 4 pct.
 • M6 spring washer DIN 127 (AW-S 6) - 2 pcs.
 • M6 nut DIN 934 (AN-H 6) - 2 pcs.
 Assembly instructions: CP X-2 H00 M
 To mount the PM x H00 M mounting plate on the LG-V6 fixing elements, drill the mounting holes with a Ø6 drill

Note: mounting plates for HVL EK 00 disconnectors available while stocks last.

Mounting plates for KVL00 disconnectors and modular equipment

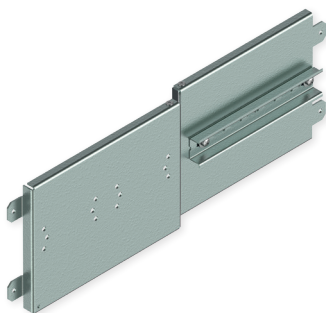

Mounting plates for KVL00 disconnectors and modular equipment				
Type	Description	Code nr	Weight (kg)	Packaging (pcs)
PM 1 K00 M	Mounting plate 1xKVL00 with TH35 rail for 4 mod. (250)	001340500	0,57	1
PM 1.4 K00 M	Mounting plate 1xKVL00 with TH35 rail for 5 mod. (350)	001340501	1,03	1
PM 2 K00 M	Mounting plate 1xKVL00 with TH35 rail for 9 mod. (500)	001340502	1,40	1
PM 2.2 K00 M	Mounting plate 1xKVL00 with TH35 rail for 10 mod. (550)	001340503	1,61	1
PM 3 K00 M	Mounting plate 1xKVL00 with TH35 rail for 16 mod. (750)	001340504	2,20	1

To attach one piece of KVL00 disconnector to the mounting plate, you should buy:
 • M6x16 DIN 933 screw (AS-H 6x16) - 4 pcs.
 • M6 washer DIN 126 (AW-R 6) - 8 pcs
 • M6 spring washer DIN 127 (AW-S 6) - 4 pcs.
 • M6 nut DIN 934 (AN-H 6) - 4 pcs.
 Assembly instructions: CP X-2 K00 M
 To mount the PM x K00 M mounting plate on the LG-V6 fixing elements, drill the mounting holes with a Ø6 drill

Mounting plates for ED2 / EB2 disconnectors / circuit breakers (125, 160, 250 A) or LBS disconnectors (160 A) and modular equipment

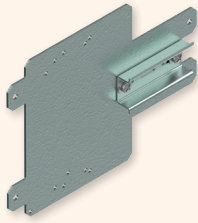

Mounting plates for ED2 / EB2 disconnectors / circuit breakers 125, 160, 250 3P or LBS disconnectors 160 3P and modular equipment

Type	Description	Code nr	Weight (kg)	Packaging (pcs)
PM 1 E12 M 3P	1x EB2 / ED2 3P mounting plate with TH35 rail for 4 mod. (250)	001101570	0,43	1

To attach one piece of the EB2 / ED2 disconnector / circuit breaker in the 3P version on the mounting plate, you should buy:

- washer M4 DIN 126 (AW-R 4) - 2 pcs.
- spring washer M4 DIN 127 (AW-S 4) - 2 pcs.
- nut M4 DIN 934 (AN-H 4) - 2 pcs.

Mounting screws included with the equipment.
Assembly instructions: CP 1-2 E12 M 3P

To attach one piece of LBS 160, 250A 3,4P, you should buy:

- metric Allen screw-M5x50 (AS-SH 5x50) - 4 pcs.
- washer M5 DIN 126 (AW-R 5) - 8 pcs.
- spring washer M5 DIN 127 (AW-S 5) - 4 pcs.
- nut M5 DIN 934 (AN-H 5) - 4 pcs.

Assembly instructions: CP X-2 LBS12

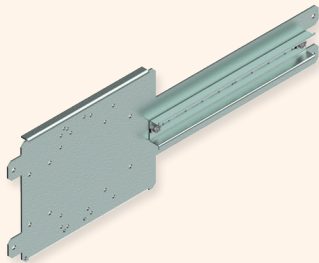

Mounting plates for ED2 / EB2 disconnectors / circuit breakers 125, 160, 250 4P or LBS disconnectors 160 4P and modular equipment

Type	Description	Code nr	Weight (kg)	Packaging (pcs)
PM 1.4 E12 M	1x EB2 / ED2 mounting plate with TH35 rail for 4 mod. (350)	001101571	0,68	1
PM 2 E12 M	1x EB2 / ED2 mounting plate with TH35 rail for 12 mod. (500)	001101572	0,94	1
PM 2.2 E12 M	1x EB2 / ED2 mounting plate with TH35 rail for 14 mod. (550)	001101573	1,03	1
PM 3 E12 M	1x EB2 / ED2 mounting plate with TH35 rail for 25 mod. (750)	001101574	1,36	1
PM 3.8 E12 M	1x EB2 / ED2 mounting plate with TH35 rail for 36 mod. (950)	001101575	1,70	1

To attach one piece of the EB2 / ED2 disconnector / circuit breaker in the 3P version on the mounting plate, you should buy:

3P version:

- washer M4 DIN 126 (AW-R 4) - 2 pcs.
- spring washer M4 DIN 127 (AW-S 4) - 2 pcs.
- nut M4 DIN 934 (AN-H 4) - 2 pcs.

4P version:

- washer M4 DIN 126 (AW-R 4) - 4 pcs.
- spring washer M4 DIN 127 (AW-S 4) - 4 pcs.
- nut M4 DIN 934 (AN-H 4) - 4 pcs.

Mounting screws included with the equipment.
Assembly instructions: CP X-2 E12 M
To mount the PM x E12 M mounting plate on the LG-V6 fixing elements, drill the mounting holes with a Ø6 drill

To attach one piece of LBS 160, 250A 3,4P, you should buy:

- metric Allen screw-M5x50 (AS-SH 5x50) - 4 pcs.
- washer M5 DIN 126 (AW-R 5) - 8 pcs.
- spring washer M5 DIN 127 (AW-S 5) - 4 pcs.
- nut M5 DIN 934 (AN-H 5) - 4 pcs.

Assembly instructions: CP X-2 LBS12

Mounting plates for HVL EK 00 disconnectors

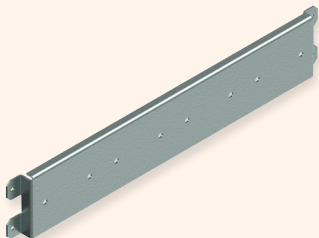

Mounting plates for HVL EK 00 disconnectors

Type	Description	Code nr	Weight (kg)	Packaging (pcs)
PM 1 H00	Mounting plate 1xHVL EK 00 (250)	001101577	0,32	1
PM 1.4 H00	Mounting plate 2xHVL EK 00 (350)	001101578	0,46	1
PM 2 H00	Mounting plate 4xHVL EK 00 (500)	001101579	0,70	1
PM 2.2 H00	Mounting plate 4xHVL EK 00 (550)	001101580	0,78	1
PM 3 H00	Mounting plate 6xHVL EK 00 (750)	001101581	1,08	1
PM 3.8 H00	Mounting plate 8xHVL EK 00 (950)	001101582	1,39	1

To mount one piece of the HVL EK 00 disconnector on the mounting plate, you should purchase:

- screw M6x16 DIN 933 (AS-H 6x16) - 2 pcs.
- washer M6 DIN 126 (AW-R 6) - 4 items
- spring washer M6 DIN 127 (AW-S 6) - 2 pcs.
- nut M6 DIN 934 (AN-H 6) - 2 pcs.

Assembly instructions: CP X-2 H00
To mount the PM x H00 mounting plate on the LG-V6 fixing elements, drill the mounting holes with a Ø6 drill

Note: Mounting plates for HVL EK 00 disconnectors available while stocks last.

Mounting plates for KVL00 disconnectors

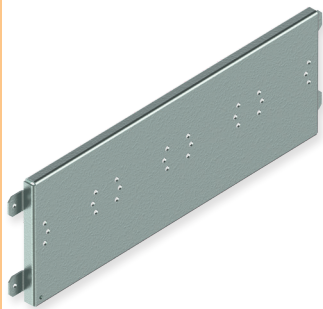

Mounting plates for KVL00 disconnectors

Type	Description	Code nr	Weight (kg)	Packaging (pcs)
PM 1 K00	Mounting plate 1xKVL00 (250)	001340550	0,61	1
PM 1.4 K00	Mounting plate 2xKVL00 (350)	001340551	0,91	1
PM 2 K00	Mounting plate 4xKVL00 (500)	001340552	1,40	1
PM 2.2 K00	Mounting plate 4xKVL00 (550)	001340553	1,51	1
PM 3 K00	Mounting plate 6xKVL00 (750)	001340554	2,15	1

To attach one piece of KVL00 disconnector to the mounting plate, you should buy:

- screw M6x16 DIN 933 (AS-H 6x16) - 4 pcs.
- washer M6 DIN 126 (AW-R 6) - 8 items
- spring washer M6 DIN 127 (AW-S 6) - 4 pcs.
- nut M6 DIN 934 (AN-H 6) - 4 pcs.

Assembly instructions: CP X-2 K00

To mount the PM x K00 mounting plate on the LG-V6 fixing elements, drill the mounting holes with a Ø6 drill

Mounting plates for ED2 / EB2 disconnectors / circuit breakers (125, 160, 250 A) or LBS disconnectors (160, 250 A)

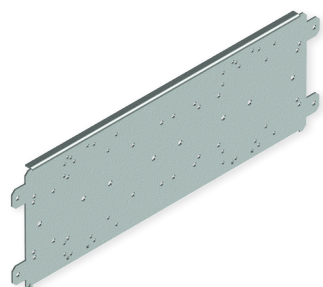

Mounting plates for ED2 / EB2 disconnectors / circuit breakers (125, 160, 250 A) or LBS disconnectors (160, 250 A)

Type	Description	Code nr	Weight (kg)	Packaging (pcs)
PM 1 E12 L12	Mounting plate 1xEB2/ED2 125,160,250 A 3,4P or 1xLBS (250)	001101584	0,49	1
PM 1.4 E12 L12	Mounting plate 1xEB2/ED2 125,160,250 A 3,4P or 1xLBS (350)	001101585	0,76	1
PM 2 E12 L12	Mounting plate 2xEB2/ED2 125,160,250 A 3,4P or 2xLBS (500)	001101586	1,15	1
PM 2.2 E12 L12	Mounting plate 2xEB2/ED2 125,160,250 A 3,4P or 2xLBS (550)	001101587	1,29	1
PM 3 E12 L12	Mounting plate 3xEB2/ED2 125,160,250 A 3,4P or 3xLBS (750)	001101588	1,82	1
PM 3.8 E12 L12	Mounting plate 3xEB2/ED2 125,160,250 A 3,4P or 3xLBS (950)	001101589	2,35	1

To attach one piece of the EB2 / ED2 circuit breaker / disconnector on the mounting plate, you should purchase:

version 3P

- washer M4 DIN 126 (AW-R 4) - 2 pcs.
- spring washer M4 DIN 127 (AW-S 4) - 2 pcs.
- nut M4 DIN 934 (AN-H 4) W - 2 pcs.

4P version

- washer M4 DIN 126 (AW-R 4) - 4 pcs.
- spring washer M4 DIN 127 (AW-S 4) - 4 pcs.
- nut M4 DIN 934 (AN-H 4) - 4 pcs.

Mounting screws included with the equipment.

Assembly instructions: CP X-2 E12

To attach one piece of LBS 160, 250A 3,4P, you should buy:

- metric Allen screw-M5x50 (AS-SH 5x50) - 4 pcs
- washer M5 DIN 126 (AW-R 5) - 8 pcs.
- spring washer M5 DIN 127 (AW-S 5) - 4 pcs.
- nut M5 DIN 934 (AN-H 5) - 4 pcs.

Assembly instructions: CP X-2 LBS12

To mount the PM x E12 L12 mounting plate on the LG-V6 fixing elements, drill the mounting holes with a Ø6 drill

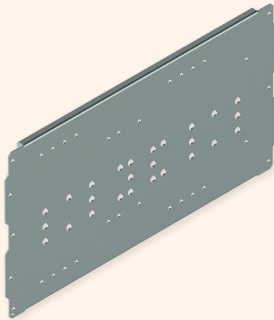
Mounting plates for EB2 / ED2 circuit breakers / disconnectors (400, 630 A), LBS disconnectors (400, 630 A) or KVL 1,2,3 disconnectors

Mounting plates for EB2 / ED2 circuit breakers / disconnectors (400, 630 A), LBS disconnectors (400, 630 A) or KVL 1,2,3 disconnectors

Type	Description	Code nr	Weight (kg)	Packaging (pcs)
PM 1 ELS46 K1	Mounting plate 1xEB2/ED2/LBS 400, 630A 3P or 1xKVL1 (250)	001340700	1,65	1
PM 1.4 ELS46 K123	Mounting plate 1xEB2/ED2/LBS 400, 630A 3,4P or 1xKVL1,2,3 (350)	001340701	1,89	1
PM 2 ELS46 K123	Mounting plate 2xEB2/ED2/LBS 400, 630A 3P or 1xLBS 400, 630A 4P or 2xKVL1,2 or 1xKVL3 (500)	001340702	2,30	1
PM 2.2 ELS46 K123	Mounting plate 2xEB2/ED2/LBS 400, 630A 3P or 1xLBS 400, 630A 4P or 2xKVL1,2 or 1xKVL3 (550)	001340703	2,47	1
PM 3 ELS46 K123	Mounting plate 3xEB2/ED2/LBS 400, 630A 3P or 1xLBS 400, 630A 4P 3xKVL1,2 or 2xKVL3 (750)	001340704	3,55	1

To attach one piece of the EB2 / ED2 400, 630 A circuit breaker / disconnector:

- washer M6 DIN 126 (AW-R 6) - 4 pcs.
 - spring washer M6 DIN 127 (AW-S 6) - 4 pcs.
 - nut M6 DIN 934 (AN-H 6) - 4 pcs.
- Mounting screws included with the equipment.
Assembly instructions: CP X-2 E46

For mounting one piece of LBS 400, 630 A disconnector it is necessary to buy:

- metric Allen screw - M6x50 (AS-SH 6x50) - 4 pcs
 - washer M6 DIN 126 (AW-R 6) - 8 pcs.
 - spring washer M6 DIN 127 (AW-S 6) - 4 pcs.
 - nut M6 DIN 934 (AN-H 6) - 4 pcs.
- Assembly instructions: CP X-2 LBS46

To attach one piece of KVL1 disconnector it is necessary to buy:

- screw M10x30 (AS-H 10x30) - 4 pcs.
 - washer M10 DIN 126 (AW-R 10) - 4 pcs.
 - spring washer M10 DIN 127 (AW-S 10) - 4 pcs.
 - nut M10 DIN 934 (AN-H 10) - 4 pcs.
- Assembly instructions: CP X-2 K1

To attach one piece of the KVL2,3 disconnector it is necessary to buy:

- screw M10x40 (AS-H 10x40) - 4 pcs.
 - washer M10 DIN 126 (AW-R 10) - 4 pcs.
 - spring washer M10 DIN 127 (AW-S 10) - 4 pcs.
 - nut M10 DIN 934 (AN-H 10) - 4 pcs.
- Assembly instructions: CP X-2 K1

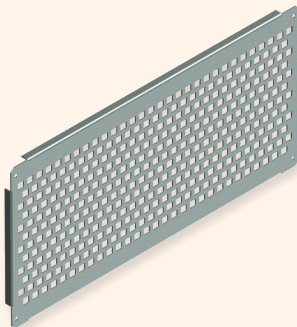
Perforated mounting plates

Perforated mounting plates

Type	Description	Code nr	Weight (kg)	Packaging (pcs)
PM 1-1 PER-A	Perforaten mounting plate type A (250)	001101620	0,17	1
PM 1-2 PER-A	Perforaten mounting plate type A (250)	001101621	0,48	1
PM 1-3 PER-A	Perforaten mounting plate type A (250)	001101622	0,76	1
PM 1-4 PER-A	Perforaten mounting plate type A (250)	001101623	1,04	1
PM 2-1 PER-A	Perforaten mounting plate type A (500)	001101624	0,38	1
PM 2-2 PER-A	Perforaten mounting plate type A (500)	001101625	0,97	1
PM 2-3 PER-A	Perforaten mounting plate type A (500)	001101626	1,51	1
PM 2-4 PER-A	Perforaten mounting plate type A (500)	001101627	2,05	1
PM 3-1 PER-A	Perforaten mounting plate type A (750)	001101628	0,57	1
PM 3-2 PER-A	Perforaten mounting plate type A (750)	001101629	1,48	1
PM 3-3 PER-A	Perforaten mounting plate type A (750)	001101630	2,29	1
PM 3-4 PER-A	Perforaten mounting plate type A (750)	001101631	3,10	1

9.5 mm x 9.5 mm perforation holes

Assembly instructions: PM X-Y PER-A

To mount the PM X-Y PER-A mounting plate on the LG-V6 fixing elements, drill the mounting holes with a Ø6 drill

Non-perforated mounting plates - universal

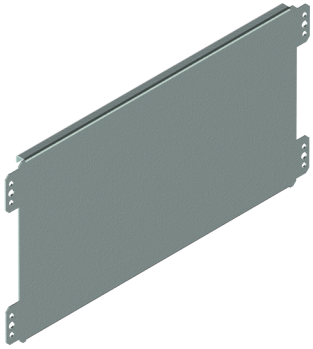

Non-perforated universal mounting plates 240 mm of height				
Type	Description	Code nr	Weight (kg)	Packaging (pcs)
PM-F 1-24	Universal mounting plate (250)	001341000	0,78	1
PM-F 1.4-24	Universal mounting plate (350)	001341001	1,22	1
PM-F 2-24	Universal mounting plate (500)	001341002	1,87	1
PM-F 2.2-24	Universal mounting plate (550)	001341003	2,09	1
PM-F 3-24	Universal mounting plate (750)	001341004	2,99	1

Assembly instructions: PM-F

To mount the PMx-24 mounting plate on the LG-V6 fixing elements, drill the mounting holes with a Ø6 drill

PM-G mounting plates for HXS enclosures



Mounting plates 1800 mm of height				
Type	Description	Code nr	Weight (kg)	Packaging (pcs)
PM-G 1-12	Mounting plate of height 12 (1800) and width 1 (250)	001337963	7,95	1
PM-G 2-12	Mounting plate of height 12 (1800) and width 2 (500)	001337965	15,11	1
PM-G 3-12	Mounting plate of height 12 (1800) and width 3 (750)	001337967	22,26	1
PM-G 4-12	Mounting plate of height 12 (1800) and width 4 (1000)	001337969	36,83	1

Assembly instructions: PM-G

Mounting plates 1950 mm of height				
Type	Description	Code nr	Weight (kg)	Packaging (pcs)
PM-G 1-13	Mounting plate of height 13 (1950) and width 1 (250)	001337970	8,62	1
PM-G 2-13	Mounting plate of height 13 (1950) and width 2 (500)	001337972	16,42	1
PM-G 3-13	Mounting plate of height 13 (1950) and width 3 (750)	001337974	24,52	1
PM-G 4-13	Mounting plate of height 13 (1950) and width 4 (1000)	001337976	39,88	1

Assembly instructions: PM-G

Mounting the plate on the back of the enclosure:

To mount one PM-G on the back of the enclosure, must be ordered:

- side bracket for mounting the mounting plate on the back of the enclosure
UA-B - 3 sets

For fixing the PM-G mounting plate on the back of the enclosure with additional stiffening or using the PM-G plate with a width less than the width of the enclosure, the following should be purchased:

- side bracket for mounting the mounting plate on the back of the enclosure
UA-B - 2 sets
- stiffening bar for mounting on the rear wall of the enclosure
BL-UA - 1 set
- mounting bracket for PM-G plates on stiffening bars
BU-PM - 1 set *

- side bracket for PM-G plates with depth adjustment
UR-B - 3 sets
- additional CR-A element - 3 sets

For fixing the PM-G mounting plate with depth adjustment ** with additional stiffening or using the PM-G panel with a width less than the width of the enclosure, it is necessary to buy:

- side bracket for PM-G plates with depth adjustment
UR-B - 2 sets
- stiffening bar with adjustable mounting depth BL-UR - 1 set.
- mounting bracket for PM-G plates on stiffening bars
BU-PM - 1 set *
- additional CR-A element - 3 sets

Installation of the depth control panel **:

To mount one PM-G plate with depth adjustment, order:

* to provide a center support point for mounting plate, additional BU-PM brackets should be ordered (their number depends on the number of support points of the plate)

** in order to ensure the possibility of adjusting the installation depth of PM-G plates, the enclosure must be equipped with internal set holders with depth control UW-BCR

Vertical supports

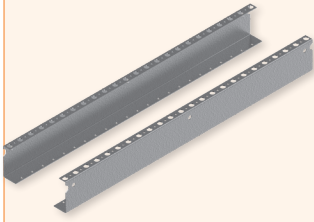

WP-U vertical supports

Type	Description	Code nr	Weight (kg)	Packaging (pcs)
WP-U 2.33	Vertical support 1 position type U (350) (1 set = 2 pcs.)	001101717	0,81	1
WP-U 3	Vertical support 1 position type U (450) (1 set = 2 pcs.)	001101666	1,06	1
WP-U 3.66	Vertical support 1 position type U (550) (1 set = 2 pcs.)	001101667	1,30	1
WP-U 4	Vertical support 1 position type U (600) (1 set = 2 pcs.)	001101668	1,42	1
WP-U 5	Vertical support 1 position type U (750) (1 set = 2 pcs.)	001101669	1,78	1
WP-U 6	Vertical support 1 position type U (900) (1 set = 2 pcs.)	001101670	2,15	1
WP-U 6.33	Vertical support 1 position type U (950) (1 set = 2 pcs.)	001101671	2,27	1
WP-U 7	Vertical support 1 position type U (1050) (1 set = 2 pcs.)	001101672	2,51	1
WP-U 7.66	Vertical support 1 position type U (1150) (1 set = 2 pcs.)	001101673	2,75	1

Assembly instructions: WP-U

Note: WP-U supports do not require additional fixings, TH rails and PM plates are screwed directly to the support.

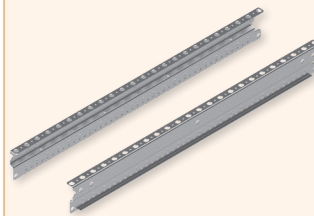

WP-A vertical supports

Type	Description	Code nr	Weight (kg)	Packaging (pcs)
WP-A 2	Vertical support 2 position type A (300) (1 set = left and right)	001338600	0,50	1
WP-A 2.33	Vertical support 2 position type A (350) (1 set = left and right)	001101716	0,68	1
WP-A 3	Vertical support 2 position type A (450) (1 set = left and right)	001101644	0,89	1
WP-A 3.66	Vertical support 2 position type A (550) (1 set = left and right)	001101645	1,09	1
WP-A 4	Vertical support 2 position type A (600) (1 set = left and right)	001101646	1,2	1
WP-A 5	Vertical support 2 position type A (750) (1 set = left and right)	001101647	1,51	1
WP-A 6	Vertical support 2 position type A (900) (1 set = left and right)	001101648	1,82	1
WP-A 6.33	Vertical support 2 position type A (950) (1 set = left and right)	001101649	1,92	1
WP-A 7	Vertical support 2 position type A (1050) (1 set = left and right)	001101650	2,13	1
WP-A 7.66	Vertical support 2 position type A (1150) (1 set = left and right)	001101651	2,34	1
WP-A 8	Vertical support 2 position type A (1200) (1 set = left and right)	001338601	2,42	1
WP-A 9	Vertical support 2 position type A (1350) (1 set = left and right)	001338602	2,73	1
WP-A 10	Vertical support 2 position type A (1500) (1 set = left and right)	001338603	3,03	1
WP-A 11	Vertical support 2 position type A (1650) (1 set = left and right)	001338604	3,33	1
WP-A 12	Vertical support 2 position type A (1800) (1 set = left and right)	001338605	3,65	1
WP-A 13	Vertical support 2 position type A (1950) (1 set = left and right)	001338606	3,85	1

Assembly instructions: WP-A

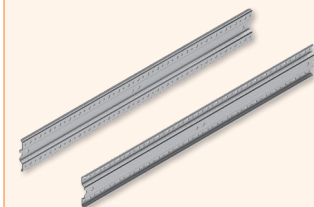

Reinforced vertical supports WP-T

Type	Description	Code nr	Weight (kg)	Packaging (pcs)
WP-T 7	Reinforced vertical support 2 position type A (1050) (1 set = left and right)	001338758	2,50	1
WP-T 12	Reinforced vertical support 2 position type A (1800) (1 set = left and right)	001338764	4,27	1
WP-T 13	Reinforced vertical support 2 position type A (1950) (1 set = left and right)	001338765	4,55	1

Assembly instructions: WP-T

Note: WP-T supports do not have the possibility to attach CP covers.

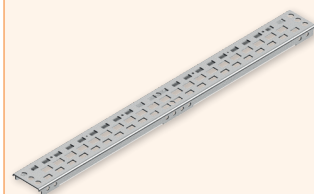

WD-K vertical supports

Type	Description	Code nr	Weight (kg)	Packaging (pcs)
WD-K 12	Type K vertical support for cage nuts (1800) (1 pc.)	001338864	2,14	1
WD-K 13	Type K vertical support for cage nuts (1950) (1 pc.)	001338865	2,27	1

Assembly instructions: WD-K

Note: WD-K supports do not have the option of fixing CP covers.

The cage nuts are sold separately (p. 100).

Internal set brackets

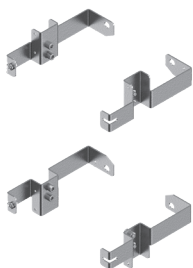

Internal set brackets for GT enclosures 150-250 mm deep (without adjustment)

Type	Description	Code nr	Weight (kg)	Packaging (pcs)
UW-GT 150	Internal set brackets for GT enclosures 150 mm (1 set = 4 pcs.)	001101705	0,49	1
UW-GT 200	Internal set brackets for GT enclosures 200 mm (1 set = 4 pcs.)	001101706	0,58	1
UW-GT 250	Internal set brackets for GT enclosures 250 mm (1 set = 4 pcs.)	001101707	0,67	1

Includes: 4 x brackets + 6 x washers + 8 x M6x10 Allen screws + 2 x M5x10 screws + 2 x M5 nuts
 Assembly instructions: UW-GT

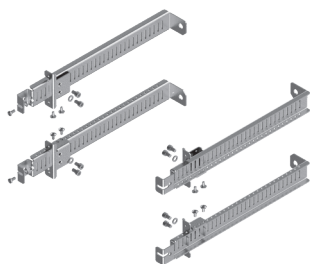

Internal set brackets for GT enclosures 300-400 mm deep (with adjustment)

Type	Description	Code nr	Weight (kg)	Packaging (pcs)
UW-GT 300	Internal set brackets for GT enclosures 300 mm deep (1 set = 4 pcs.)	001101708	0,82	1
UW-GT 400	Internal set brackets for GT enclosures 400 mm deep (1 set = 4 pcs.)	001101709	1,05	1

Includes: 4 x brackets + 4 x leading elements + 4 x washers + 8 x Allen screws M6x10 + 8 x self-tapping screws PH2 + 2 x screws M5x10 + 2 x nuts M5
 Assembly instructions: UW-GT

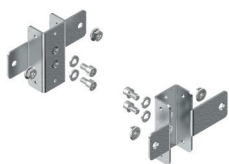

2 position internal set bracket for HXS enclosures

Type	Description	Code nr	Weight (kg)	Packaging (pcs)
UW-BCU 23	2 position internal set bracket for HXS enclosures 300 mm deep (1 set = 2 pcs.)	001338201	0,27	1
UW-BCU 4	2 position internal set bracket for HXS enclosures 400 mm deep (1 set = 2 pcs.)	001338202	0,31	1

Includes: 2 x brackets + 4 x washers + 4 x M6x10 Allen screws + 4 x M6 nuts
 Assembly instructions: UW-BCU

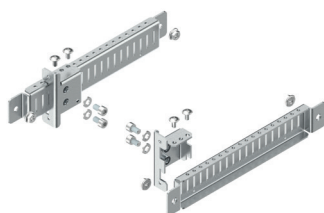

Internal set holder with depth adjustment for HXS enclosures

Type	Description	Code nr	Weight (kg)	Packaging (pcs)
UW-BCR 3	Internal set holder with depth adjustment for HXS enclosures 300 mm deep (1 set = 2 pcs.)	001338206	0,55	1
UW-BCR 4	Internal set holder with depth adjustment for HXS enclosures 400 mm deep (1 set = 2 pcs.)	001338207	0,68	1

Includes: 2 x holders + 2 x leading elements + 4 x washers + 4 x Allen screws M6x10 + 4 x self-tapping screws PH2 + 4 x M6 nuts
 Assembly instructions: UW-BCR



Additional leading element without fixing possibility of additional covers

Type	Description	Code nr	Weight (kg)	Packaging (pcs)
CR-A	Additional leading element without fixing possibility of additional covers (1 set = 2 pcs.)	001338215	0,13	1

Assembly instructions: CR-A

Elements for dividing the internal set



Dividing support for HXS enclosures

Type	Description	Code nr	Weight (kg)	Packaging (pcs)
UW-SEP 3	Dividing support for HXS enclosures with a depth of 300 mm	001338302	0,21	1
UW-SEP 4	Dividing support for HXS enclosures with a depth of 400 mm	001338303	0,29	1

Includes: 1 x dividing support + 1 x additional covers connector + 2 x M6 nuts
 Assembly instructions: UW-SEP



Dividing element EP-W (set)

Type	Description	Code nr	Weight (kg)	Packaging (pcs)
EP-W	Dividing element of the enclosure (1 set = 2 pcs.)	001101677	0,11	1

Includes: 2 x dividing elements + 4 x washers + 4 x M6x10 allen screws + 6 x self-tapping screws PH2
 Assembly instructions: EP-W



Dividing element for mounting the WP-T support

Type	Description	Code nr	Weight (kg)	Packaging (pcs)
EP-A	Dividing element for mounting the WP-T support on the UW-SEP element (1 set = 2 pcs.)	001338306	0,14	1

Includes: 2 x dividing elements + 2 x washers + 2 x M8x16 allen screws + 6 x self-tapping screws PH2
 Assembly instructions: EP-A



BL bars for dividing the internal set horizontally

Type	Description	Code nr	Weight (kg)	Packaging (pcs)
BL-WP 2	Dividing bar width 2 (500) division 1: 1	001338900	0,47	1
BL-WP 3	Dividing bar width 2 (500) division 1:1:1 / 2:1 / 1:2	001338901	0,73	1

The set includes:
 BL-WP 2: 500 mm wide dividing bar, 8 self-tapping screws, 1 bracket for screwing the internal set, 1 M8 Allen screw with washer.
 BL-WP 3: 750 mm wide dividing bar, 10 self-tapping screws, 2 brackets for screwing the internal set, 2 M8 Allen screws with washer.
 Assembly instructions: BL-WP

Elements for mounting PM-G plates and WD brackets



Side bracket for mounting PM-G plate in HXS series enclosures

Type	Description	Code nr	Weight (kg)	Packaging (pcs)
UA-B	Side bracket for PM-G plates mounted on the back of the enclosure (1 set = 2 pcs.)	001338102	0,15	1

Assembly instructions: UA-B



Side bracket for mounting WD supports in HXS series enclosures

Type	Description	Code nr	Weight (kg)	Packaging (pcs)
UA-B-WD	Side bracket for WD supports mounted on the back of the enclosure (1 set = 2 pcs.)	001338103	0,14	1

Assembly instructions: UA-B-WD



Center bracket for mounting PM-G plates and WD support in HXS series enclosures

Type	Description	Code nr	Weight (kg)	Packaging (pcs)
UA-S	Center bracket for PM-G plates and WD support mounted on the back of the enclosure (1 set = 2 pcs.)	001338104	0,25	1

Assembly instructions: UA-S

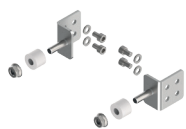

Side bracket for mounting PM-G plates with depth adjustment in HXS series enclosures

Type	Description	Code nr	Weight (kg)	Packaging (pcs)
UR-B	Side bracket for mounting PM-G plates with depth adjustment (1 set = 2 pcs.)	001338115	0,17	1

Assembly instructions: UR-B



Side bracket for mounting WD supports with depth adjustment in HXS series enclosures

Type	Description	Code nr	Weight (kg)	Packaging (pcs)
UR-B-WD	Side bracket for mounting WD supports with depth adjustment (1 set = 2 pcs.)	001338116	0,31	1

Assembly instructions: UR-B-WD



Center bracket for mounting PM-G plates and WD supports with depth adjustment in HXS series enclosures

Type	Description	Code nr	Weight (kg)	Packaging (pcs)
UR-S	Center bracket for PM-G plates and WD supports with depth adjustment (1 set = 2 pcs.)	001338117	0,22	1

Assembly instructions: UR-S

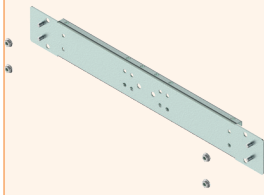

Stiffening bars for PM-G plates and WD supports mounted on the back of the enclosure

Type	Description	Code nr	Weight (kg)	Packaging (pcs)
BL-UA 2	Stiffening bar mounted directly to the enclosure, width 2 (500) (1 set)	001338130	0,78	1
BL-UA 3	Stiffening bar mounted directly to the enclosure, width 3 (750) (1 set)	001338131	1,17	1
BL-UA 4	Stiffening bar mounted directly to the enclosure, width 4 (1000) (1 set)	001338132	1,50	1

Assembly instructions: BL-UA

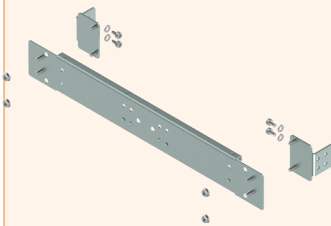

Stiffening bars for PM-G plates and WD supports with adjustable mounting depth

Type	Description	Code nr	Weight (kg)	Packaging (pcs)
BL-UR 2	Stiffening bar with adjustable depth, width 2 (500) (1 set)	001338145	1,02	1
BL-UR 3	Stiffening bar with adjustable depth, width 3 (750) (1 set)	001338146	1,41	1
BL-UR 4	Stiffening bar with adjustable depth, width 4 (1000) (1 set)	001338147	1,73	1

Assembly instructions: BL-UR

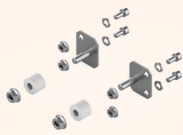

Mounting bracket for PM-G plates on BL-UA and BL-UR stiffening bars

Type	Description	Code nr	Weight (kg)	Packaging (pcs)
BU-PM	Bracket for mounting plates, fixed to a stiffening bar (1 set = 2 pcs.)	001338160	0,12	1

Assembly instructions: BU-PM

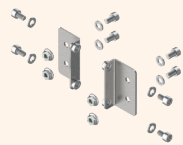

Bracket for mounting WD support on BL-UA and BL-UR stiffening bars

Type	Description	Code nr	Weight (kg)	Packaging (pcs)
BU-WD	Bracket for WD supports, fixed to a stiffening bars (1 set = 2 pcs.)	001338161	0,18	1

Assembly instructions: BU-WD

Ways of mounting TH rail and PM mounting plates:



In order to mount **TH-S** rails to WP-A vertical supports, it is necessary to purchase one **LG-V SET** with code number **001101683** or to purchase individual elements as listed in the table below. When mounting TH-S rails on the WP-U support, it is need to use 2 self-tapping screws AST 4.8x9.5.

Type	Description	Quantity (pcs.)
LG-V	Fixing element with M5 nut	2
AST 4.8x9.5	Self-tapping screw PH2	4
AW-RE 5	Widened washer	2
AS-C 5x10	Metric screw PH2	2

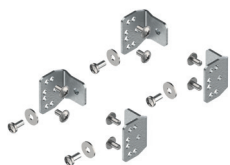

To mount the **PM ... H00 M**, **PM E12 M**, **PM ... H00**, **PM ... E12 L12** mounting plates for ED2 / EB2 disconnectors and circuit breakers and LA1 and LBS1 disconnectors for WP-A vertical supports, it is necessary to purchase **2 LG-V SET** assembly kits code number **001101683** or purchase of individual items as listed in the table below.

Type	Description	Quantity (pcs.)
LG-V	Fixing element with M5 nut	4
AST 4.8x9.5	Self-tapping screw PH2	8
AW-RE 5	Widened washer	4
AS-C 5x10	Metric screw PH2	4

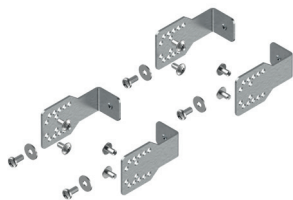

In order to mount the **PM ... E12 L12** mounting plate for the LA2, LBS2 disconnectors to WP-A vertical supports, it is necessary to buy **2 LG-V5 SET** assembly kits with code number **001101685** or buy individual elements as listed in the table below.

Type	Description	Quantity (pcs.)
LG-V5	Fixing element with M5 nut V5 type	4
AST 4.8x9.5	Self-tapping screw PH2	8
AW-RE 5	Widened washer	4
AS-C 5x10	Metric screw PH2	4

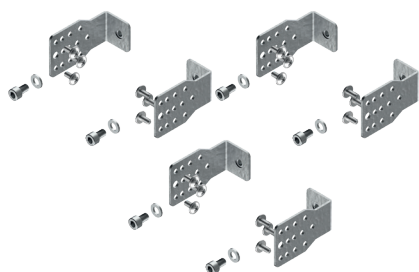

To mount the **PM ... ELS46 K123** mounting plate for the KVL1,2,3 disconnectors and ED2 / EB2 400 - 630 A disconnectors and circuit breakers to the WP-A vertical supports it is necessary to buy **3 LG-V6-B SET** assembly kits with the code number **001341151**

Type	Description	Quantity (pcs.)
LG-V6-B SET	Fixing element with M6 nut type B (1 set = 2 pcs.)	3

To mount the **PM ... ELS46 K123** mounting plate for the LBS46 400 - 630 A disconnectors to the WP-A vertical supports it is necessary to buy **2 LG-V6-D SET** assembly kits with the code number **001341153**

Type	Description	Quantity (pcs.)
LG-V6-D SET	Fixing element with M6 nut type D (1 set = 2 pcs.)	2

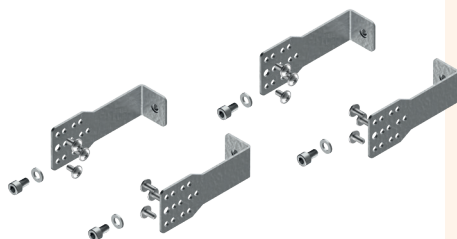

Fixing LG-V elements



Fixing element with M5 nut

Type	Description	Code nr	Weight (kg)	Packaging (pcs)
LG-V	Fixing element with M5 nut	001101679	0,03	50

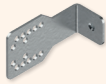

Fixing element with M5 nut type V5

Type	Description	Code nr	Weight (kg)	Packaging (pcs)
LG-V5	Fixing element with M5 nut type V5	001101681	0,04	20



Fixing element with M5 nut (1 set = 2 pcs.)

Type	Description	Code nr	Weight (kg)	Packaging (pcs)
LG-V SET	Fixing element with M5 nut (1 set = 2 pcs.)	001101683	0,07	1

Assembly instructions: LG-V SET

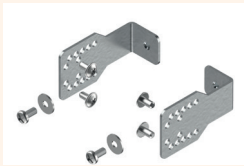

Fixing element with M5 nut type V5 (1 set = 2 pcs.)

Type	Description	Code nr	Weight (kg)	Packaging (pcs)
LG-V5 SET	Fixing element with M5 nut type V5 (1 set = 2 pcs.)	001101685	0,09	1

Assembly instructions: LG-V5 SET

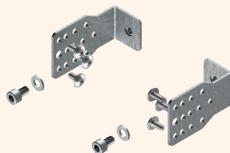

Fastening element with M6 nut type V6-B (1 set = 2 pcs.)

Type	Description	Code nr	Weight (kg)	Packaging (pcs)
LG-V6-B SET	Fastening element with M6 nut type V6-B (1 set = 2 pcs.)	001341151	0,11	1

Assembly instructions: LG-V6-B SET

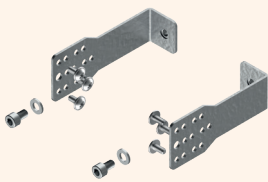

Fixing element with M6 nut type V6-D (1 set = 2 pcs.)

Type	Description	Code nr	Weight (kg)	Packaging (pcs)
LG-V6-D SET	Fixing element with M6 nut type V6-D (1 set = 2 pcs.)	001341153	0,14	1

Assembly instructions: LG-V6-D SET

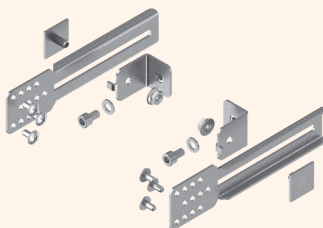

Fixing element with smooth depth adjustment type V6R-B (1 set = 2 pcs.)

Type	Description	Code nr	Weight (kg)	Packaging (pcs)
LG-V6R-B SET	Fixing element with smooth depth adjustment type V6R-B (1 set = 2 pcs.)	001341201	0,25	1

Assembly instructions: LG-V6R-B SET

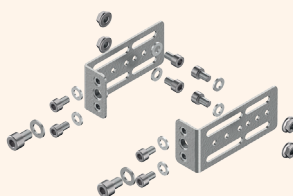

Fixing element for WP-T supports type T6-A

Type	Description	Code nr	Weight (kg)	Packaging (pcs)
LG-T6-A SET	Fixing element for WP-T supports type T6-A (1 set = 2 pcs.)	001341880	0,22	1

Assembly instructions: LG-T6-A SET

Supports with insulating carriers for busbars



Support with BBS carrier for 1 busbar mounted horizontally on WP-A support

Type	Description	Code nr	Weight (kg)	Packaging (pcs)
LG-B60-H P1	Support with 1-pole BBS carrier	001341650	0,16	1

Assembly instructions: LG-B60-H



Support with BBS carrier for 3 busbars with 60 mm spacing mounted horizontally on WP-A supports

Type	Description	Code nr	Weight (kg)	Packaging (pcs)
LG-B60-H P3	Support with 3-pole BBS carrier	001341651	0,34	1

Assembly instructions: LG-B60-H

At the end of insulating carriers of the busbars use additional protective insulation covers BBS-L 60/3



Support with BBS carrier for up to 4 busbars with 60 mm spacing mounted horizontally on WP-A supports

Type	Description	Code nr	Weight (kg)	Packaging (pcs)
LG-B60-H P4	Support with 4-pole BBS carrier	001341652	0,45	1

Assembly instructions: LG-B60-H

At the end of insulating carriers of the busbars use additional protective insulation L-BBS-60/4

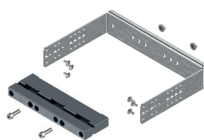

Support with BBS carrier for 3 busbars with 60 mm spacing mounted vertically on WP-A supports - step adjustment of mounting depth

Type	Description	Code nr	Weight (kg)	Packaging (pcs)
LG-B60-V1 P3	Bracket with 3-pole BBS carrier, width 1 (250)	001341700	0,53	1
LG-B60-V2 P3	Bracket with 3-pole BBS carrier, width 2 (500)	001341702	0,75	1

Assembly instructions: LG-B60-V

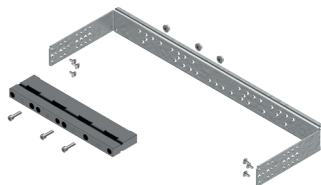

Support with BBS carrier for 4 busbars with 60 mm spacing mounted vertically on WP-A supports - step adjustment of mounting depth

Type	Description	Code nr	Weight (kg)	Packaging (pcs)
LG-B60-V2 P4	Support with 4-pole BBS carrier, width 2 (500)	001341704	0,80	1

Assembly instructions: LG-B60-V

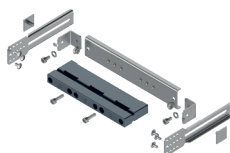

Support with BBS carrier for 3 busbars with 60 mm spacing mounted vertically on WP-A supports - smooth adjustment of the mounting depth

Type	Description	Code nr	Weight (kg)	Packaging (pcs)
LG-B60-V1R P3	Support with 3-pole BBS carrier, width 1 (250)	001341750	0,61	1
LG-B60-V2R P3	Support with 3-pole BBS carrier, width 2 (500)	001341752	0,87	1

Assembly instructions: LG-B60-VxR

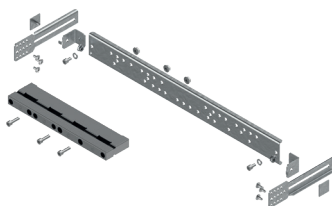

Support with BBS carrier for up to four busbars with 60 mm spacing mounted vertically on WP-A supports - smooth adjustment of the mounting depth

Type	Description	Code nr	Weight (kg)	Packaging (pcs)
LG-B60-V2R P4	Support with 4-pole BBS carrier, width 2 (500)	001341754	0,92	1

Assembly instructions: LG-B60-VxR

Note: When supports with insulating carriers are mounted in a position where busbars or fixing elements are under a distance of less than 15 mm from vertical WP-A / WP-T supports or other metal parts of the construction of the internal set, additional insulating covers should be used as recommended on pages 60-63.
Sets of supports with insulation carriers LG-B60, UD B60, LG-T-B185 and LG-T-INH are sold without busbars.



Support with BBS carrier for the busbar, horizontally mounted directly to the enclosure

Type	Description	Code nr	Weight (kg)	Packaging (pcs)
UD-B60-H P1	Support with BBS 1-pole carrier	001341800	0,48	1

Assembly instructions: UD-B60-H

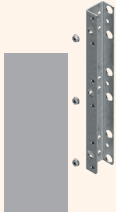

Support with BBS carrier for up to 3 busbars with 60 mm spacing mounted horizontally directly to the enclosure

Type	Description	Code nr	Weight (kg)	Packaging (pcs)
UD-B60-H P3	Support with 3-pole BBS carrier	001341802	0,55	1

Assembly instructions: UD-B60-H

At the end of insulation carriers of busbars, use additional insulating covers L-BBS-60/3 should be used



Support with BBS carrier for up to 4 busbars with 60 mm spacing mounted horizontally directly to the enclosure

Type	Description	Code nr	Weight (kg)	Packaging (pcs)
UD-B60-H P4	Support with 4-pole BBS carrier	001341803	0,60	1

Assembly instructions: UD-B60-H

At the end of insulation carriers of busbars, use additional protective insulation-BBS-L 60/4

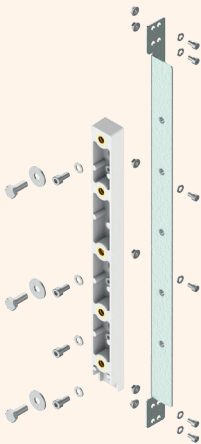

Support with POP 100/185 carrier for up to three busbars with a spacing of 100/185 mm mounted horizontally on WP-T supports

Type	Description	Code nr	Weight (kg)	Packaging (pcs)
LG-T-B185-H P3	Support with POP 100/185 3-pole carrier	001341850	2,92	1

Assembly instructions: LG-T-B185-H P3



Support with INS insulator for one horizontal busbar mounted on WP-T supports

Type	Description	Code nr	Weight (kg)	Packaging (pcs)
LG-T-INH1-A	Support with INS insulator for 1 busbar	001341851	0,13	1

Assembly instructions: LG-T-INH



Support with two INS insulators for one horizontal busbar mounted on WP-T supports

Type	Description	Code nr	Weight (kg)	Packaging (pcs)
LG-T-INH2-A	Support with two INS insulators for 1 busbar	001341852	0,31	1

Assembly instructions: LG-T-INH

Note: When supports with insulating carriers are mounted in a position where busbars or fixing elements are under a distance of less than 15 mm from vertical WP-A / WP-T supports or other metal parts of the construction of the internal set, additional insulating covers should be used as recommended on pages 60-63.

Sets of supports with insulation carriers LG-B60, UD B60, LG-T-B 185 and LG-T-INH are sold without busbars.

Accessories for the busbar system

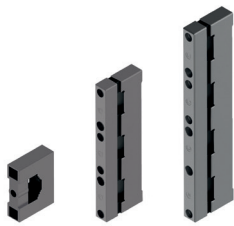

Insulation carriers for busbars with a 60 mm spacing

Type	Description	Code nr	Weight (kg)	Packaging (pcs)
BBS-60/1	Insulating carrier for 1-pole busbars	001696000	0,036	10
BBS-60/3	Insulation carrier for busbars with a thickness of 5 or 10 mm, 3-pole	001696001	0,114	10
BBS-60/4	Insulation carrier for busbars with a thickness of 5 or 10 mm, 4-pole	001696002	0,152	10

Nośniki szyn BBS-60/x sprzedawane bez śrub montażowych do przykręcenia na wsporniki.



Height adjustment element for 5 mm thick busbars

Type	Description	Code nr	Weight (kg)	Packaging (pcs)
H5-BBS	Height adjustment element for 5 mm thick busbars	001696005	0,001	100



L-BBS-60/3



BBC-60/3



BBC-1/30



L-WP-B60/3

Insulation covers

Type	Description	Code nr	Weight (kg)	Packaging (pcs)
L-BBS-60/3	Side insulation cover for 3-pole BBS carrier	001696006	0,026	10
L-BBS-60/4	Side insulation cover for 4-pole BBS carrier	001696007	0,041	10
BBC-60/3	Insulating cover 3-pole, for 30 or 20 mm wide and 10 or 5 mm thick	001696009	0,039	50
BBC-60/4	Insulating cover 3-pole, for 30 or 20 mm wide and 10 or 5 mm thick	001696010	0,048	50
BBC-1/20	Insulating cover of a single busbar, for 20 mm wide busbars and thickness 5 or 10 mm, length 1 m	001696011	0,056	20
BBC-1/30	Insulating cover of a single busbar, for 30 mm wide busbars and thickness 5 or 10 mm, length 1 m	001696012	0,076	20
L-WP-B60/3	Insulating 3-pole cover , for mounting on vertical supports, providing insulation from busbars	001342181	0,025	1
L-WP-B60/4	Insulating 4-pole cover , for mounting on vertical supports, providing insulation from busbars	001342182	0,038	1



Insulation carrier for busbars with a spacing of 100 and 185 mm

Type	Description	Code nr	Weight (kg)	Packaging (pcs)
POP 100/185	Insulation carrier for busbars with a spacing of 100 and 185 mm	001691055	0,446	1



ZP POP 185



ZP POP-WP

Insulation covers for POP 100/185 carriers

Type	Description	Code nr	Weight (kg)	Packaging (pcs)
ZP POP 100	Side insulation cover for POP 100/185 carrier, for busbars with 100 mm spacing	001691056	0,226	1
ZP POP 185	Side insulation cover for POP 100/185 carrier, for busbars with 185 mm spacing	001691057	0,226	1
ZP POP-WP	Insulating cover for mounting on vertical supports, providing insulation from the 100/185 mm system busbars	001342180	0,120	1

Membrane cable glands

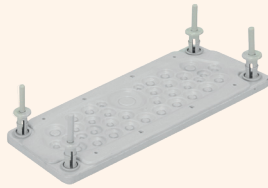

EH-TKC-36

Membrane cable gland with pins

Type	Description	Code nr	Weight (kg)	Packaging (pcs)
EH-TKC-36	Cable gland with pins (1 set)	001101711	0,19	1
	4 x 4 mm - 8 mm (IP65)			
	4 x 6 mm - 10 mm (IP65)			
	12 x 7 mm - 12 mm (IP65)			
	14 x 10 mm - 14 mm (IP65)			
	2 x 12 mm - 18 mm (IP65)			
1 x 17 mm - 32 mm (IP65)				

The set includes: 1 x membrane cable gland + 4 x fixing pin
 Assembly instructions: EH-TKC-36



EH-TC-3



EH-TC-17



EH-TC-25



EH-TC-35



EH-TKC-36-S

Membrane cable gland with M8 screws

Type	Description	Code nr	Weight (kg)	Packaging (pcs)
EH-TC-3-S	Membrane cable gland with M8 screws (1 set)	001338450	0,30	1
	2 x 24 mm - 54 mm (IP65)			
	1 x 30 mm - 59 mm (IP65) 3 x 6 mm - 14 mm (IP55)			
EH-TC-17-S	Membrane cable gland with M8 screws (1 set)	001338452	0,26	1
	9 x 18 mm - 30 mm or 10 mm - 14 mm (IP55)			
	4 x 10 mm - 15 mm (IP55)			
	4 x 5 mm - 10 mm (IP55)			
EH-TC-25-S	Membrane cable gland with M8 screws (1 set)	001338453	0,30	1
	1 x 20 mm - 26 mm (IP65) or 12 mm - 15 mm (IP55)			
	16 x 8 mm - 14 mm (IP65) or 7 mm - 10 mm (IP55)			
	4 x 14 mm - 20 mm (IP65) or 5 mm - 10 mm (IP55)			
	4 x 5 mm - 7 mm (IP65)			
EH-TC-35-S	Membrane cable gland with M8 screws (1 set)	001338454	0,29	1
	1 x 17 mm - 32 mm (IP65)			
	2 x 12 mm - 18 mm (IP65)			
	16 x 10 mm - 14 mm (IP65)			
	12 x 7 mm - 12 mm (IP65)			
	4 x 6 mm - 10 mm (IP65)			
EH-TKC-36-S	Membrane cable gland with M8 screws (1 set)	001338455	0,25	1
	4 x 4 mm - 8 mm (IP65)			
	4 x 6 mm - 10 mm (IP65)			
	12 x 7 mm - 12 mm (IP65)			
	14 x 10 mm - 14 mm (IP65)			
	2 x 12 mm - 18 mm (IP65)			
	1 x 17 mm - 32 mm (IP65)			

Includes: 1 x membrane cable glands + 4 x M8 Allen screw + 4 x M8 nut
 Assembly instructions: EH

Metal cable glands



Steel cable gland

Type	Description	Code nr	Weight (kg)	Packaging (pcs)
EH-ST	Steel cable gland	001101712	0,24	1

The set includes: 1 x steel cable gland + 4 x M8 nut
 Assembly instructions: EH



Aluminum cable gland

Type	Description	Code nr	Weight (kg)	Packaging (pcs)
EH-AL	Aluminum cable gland	001101713	0,16	1

Includes: 1 x aluminum cable gland + 4 x M8 nut
 Assembly instructions: EH

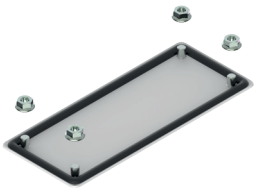

Aluminum cable gland with poured gasket with increased IP protection

Type	Description	Code nr	Weight (kg)	Packaging (pcs)
EH-AL-IPS	Aluminum cable gland with poured gasket	001338464	0,18	1

The set includes: 1 x aluminum cable gland with poured seal + 4 x M8 nut
 Assembly instructions: EH

EH-AL-IPS

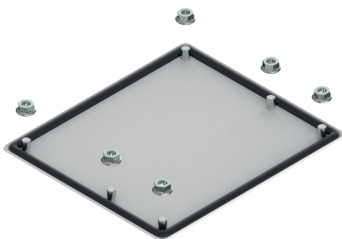

Double aluminum cable gland with a poured gasket with increased IP protection

Type	Description	Code nr	Weight (kg)	Packaging (pcs)
EH2-AL-IPS	Double aluminum cable gland with a poured gasket	001338467	0,32	1

The set includes: 1 x double aluminum cable gland with poured gasket + 4 x M8 nut
 Assembly instructions: EH

EH2-AL-IPS

Locks, inserts and keys for enclosures



LK-D3-M22
(bolt-3 mm)



LK-D5-M22
(bolt-5 mm)



LK-KW8-M22
(square bolt-8 mm)



LK-T9-M22
(triangle bolt-9 mm)

Locks for enclosures (type M22)

Type	Description	Code nr	Weight (kg)	Packaging (pcs)
LK-D3-M22*	Lock with double bit insert-3 mm	001102167	0,070	1
LK-D5-M22	Lock with double-bit insert-5 mm	001102168	0,070	1
LK-KW8-M22	Lock with square insert	001102169	0,070	1
LK-T9-M22	Lock with a triangle insert	001102170	0,070	1

* - standard equipment for GT enclosures up to 1000 mm



K-1333-M22



LK-B1333-M22



LK-CB1333-25-50



LK-1333-M22
RAL 7035

Enclosure locks (type M22) with key code 1333

Type	Description	Code nr	Weight (kg)	Packaging (pcs)
LK-1333-M22	Lock with patent insert and key code 1333	001102171	0,090	1
LK-B1333-M22	Lock with patent butterfly knob with key code 1333	001102172	0,120	1
LK-CB1333-25-50*	Lock for toothed mechanism with key code 1333	001102180	0,150	1
LK-1333-M22 RAL 7035**	Lock with patent insert and key code 1333 RAL7035	001101718	0,070	1

* - lock for GT enclosures from a height of 1000 mm with a 3-point locking system

** - standard equipment of 4XN / 4XP enclosures (there are two locks in each enclosure)



LK-WRS-D3



LK-WRS-D5



LK-WRS-KW8



LK-WRS-T9



LK-WRS-1333

Inserts for locks with a lever mechanism

Type	Description	Code nr	Weight (kg)	Packaging (pcs)
LK-WRS-D3	D3 insert for the lock with lever mechanism	001343100	0,074	1
LK-WRS-D5	D5 insert for the lock with a lever mechanism	001343101	0,075	1
LK-WRS-1333	Patent insert for lock with lever mechanism with key code 1333	001343102	0,092	1
LK-WRS-KW8	KW8 insert for the lock with lever mechanism	001343103	0,071	1
LK-WRS-T9	T9 insert for the lock with lever mechanism	001343104	0,069	1



KEY-D5-M*



KEY-KW8-M



KEY-T9-M



KEY-UNI-M



KEY-1333

Keys for locks and inserts

Type	Description	Code nr	Weight (kg)	Packaging (pcs)
KEY-D5-M	D5 key	001102173	0,040	1
KEY-T9-M	Triangle T9 key	001102174	0,040	1
KEY-KW8-M	Square 8 mm key	001102175	0,040	1
KEY-UNI-M	Universal key (for D5, T9, KW8, N locks)	001102176	0,070	1
KEY-1333	Patent key 1333	001343000	0,015	1

Other enclosure accessories



Holder for hanging 4XN160 enclosures

Type	Description	Code nr	Weight (kg)	Packaging (pcs)
UCH-2	Holder for hanging the enclosure (1 set = 2 pcs.)	001101715	0,060	1



Holder for hanging GT enclosures and fixing HXS enclosures to the walls

Type	Description	Code nr	Weight (kg)	Packaging (pcs)
U400	Holders for attaching to or on the wall - set (1 set = 4 pcs.)	001102166	0,370	1



Gasket

Type	Description	Code nr	Weight (kg)	Packaging (pcs)
SEAL-G9	Gasket for gluing -10 meters (1 set = 10 m)	001101608	0,090	1



A set for connecting enclosures in a row

Type	Description	Code nr	Weight (kg)	Packaging (pcs)
ZL-GXA-SEAL	Kit for connecting the enclosures (1 set)	001342651	0,360	1



RAL7035 repair paint

Type	Description	Code nr	Weight (kg)	Packaging (pcs)
FA-RAL7035	RAL7035 repair paint (200 ml)	001101710	0,230	1



Pliers for cutting weaknesses in CP covers

Type	Description	Code nr	Weight (kg)	Packaging (pcs)
CP-PLIER	Pliers for CP covers	001101714	0,070	1



The door grounding cable

Type	Description	Code nr	Weight (kg)	Packaging (pcs)
LPE-6	6 mm2 door grounding cable, length 200 mm	001102177	0,020	1
LPE-16 M6/M8	6 mm2 earthing cable for internal set in standing enclosures, length 300 mm	001342850	0,025	1



Pocket for documentation

Type	Description	Code nr	Weight (kg)	Packaging (pcs)
K-A4	Pocket for A4 documentation	001102178	0,160	1
K-A4-PT	Foil pocket for A4 documentation	001343200	0,028	1



Clasp for CP covers

Type	Description	Code nr	Weight (kg)	Packaging (pcs)
ZAP-CP	Clasp for CP covers	001338950	0,020	10

Screws, nuts and washers



Self tapping screws PH2

Type	Description	Code nr	Weight (kg)	Packaging (pcs)
AST 4.8x9.5 SET	Self-tapping screw PH2 (1 set = 200 pcs.)	001101686	0,400	1



Metric Allen screw

Type	Description	Code nr	Weight (kg)	Packaging (pcs)
AS-SH 5x50 SET	Metric Allen screw M5 (1 set = 10 pcs.)	001343408	0,087	1
AS-SH 6x10 SET	Metric Allen screw M6 (1 set = 10 pcs.)	001343409	0,045	1
AS-SH 6x20 SET	Metric Allen screw M6 (1 set = 10 pcs.)	001343412	0,069	1
AS-SH 6x35 SET	Metric Allen screw M6 (1 set = 10 pcs.)	001343415	0,095	1
AS-SH 6x50 SET	Metric Allen screw M6 (1 set = 10 pcs.)	001343418	0,130	1
AS-SH 8x16 SET	Metric Allen screw M8 (1 set = 10 pcs.)	001343421	0,120	1



Metric screw - PH2 DIN7985

Type	Description	Code nr	Weight (kg)	Packaging (pcs)
AS-C 4x16 SET	Metric screw - PH2 DIN7985 (1 set = 10 pcs.)	001101687	0,020	1
AS-C 4x20 SET	Metric screw - PH2 DIN7985 (1 set = 10 pcs.)	001101688	0,030	1



Śruba metryczna - krzyżak PH2 DIN7985

Type	Description	Code nr	Weight (kg)	Packaging (pcs)
AS-C 5x10 SET	Metric screw - PH2 DIN7985 (1 set = 100 pcs.)	001101689	0,300	1



Metric screw M6 - hexagon DIN933

Type	Description	Code nr	Weight (kg)	Packaging (pcs)
AS-H 6x16 SET	Metric screw M6 - hexagon DIN933 (1 set = 10 pcs.)	001101690	0,065	1
AS-H 10x30 SET	Metric screw M10 - hexagon DIN933 (1 set = 10 pcs.)	001343487	0,270	1
AS-H 10x40 SET	Metric screw M10 - hexagon DIN933 (1 set = 10 pcs.)	001343489	0,320	1



Extended washer DIN9021

Type	Description	Code nr	Weight (kg)	Packaging (pcs)
AW-RE 5 SET	Washer d=5,3 D=15 widened DIN9021 (1 set = 100 pcs.)	001101692	0,150	1



Round washers DIN126

Type	Description	Code nr	Weight (kg)	Packaging (pcs)
AW-R 4 SET	Round washer d=4,3 D=10 DIN126 (1 set = 10 pcs.)	001101693	0,003	1
AW-R 5 SET	Round washer d=5,5 D=10 DIN126 (1 set = 10 pcs.)	001343901	0,004	1
AW-R 6 SET	Round washer d=6,6 D=12 DIN126 (1 set = 10 pcs.)	001101694	0,008	1
AW-R 10 SET	Round washer d=11 D=20 DIN126 (1 set = 10 pcs.)	001343904	0,035	1



Spring washers DIN127

Type	Description	Code nr	Weight (kg)	Packaging (pcs)
AW-S 4 SET	Spring washer d=4,1 D=6,88 DIN127 (1 set = 10 pcs.)	001101696	0,002	1
AW-S 5 SET	Spring washer d=5,1 D=9,3 DIN127 (1 set = 10 pcs.)	001343913	0,003	1
AW-S 6 SET	Spring washer d=6,1 D=9,78 DIN127 (1 set = 10 pcs.)	001101698	0,007	1
AW-S 10 SET	Spring washer d=10,2 D=18,1 DIN127 (1 set = 10 pcs.)	001343916	0,040	1



Nuts DIN934

Type	Description	Code nr	Weight (kg)	Packaging (pcs)
AN-H 4 SET	Nut M4 DIN934 (1 set = 10 pcs.)	001101700	0,010	1
AN-H 5 SET	Nut M5 DIN934 (1 set = 10 pcs.)	001343713	0,018	1
AN-H 6 SET	Nut M6 DIN934 (1 set = 10 pcs.)	001101702	0,020	1
AN-H 10 SET	Nut M10 DIN934 (1 set = 10 pcs.)	001343716	0,100	1



Nuts with a collar

Type	Description	Code nr	Weight (kg)	Packaging (pcs)
AN-FSH 6 SET	M6 nuts with a collar (1 set = 10 pcs.)	001343708	0,048	1
AN-FSH 8 SET	M8 nuts with a collar (1 set = 10 pcs.)	001343709	0,072	1



Cage nuts for universal plates with perforations PM x-x PER-A

Type	Description	Code nr	Weight (kg)	Packaging (pcs)
AN-KH 9.5x9.5 M6	The M6 cage nut is inserted from the back to the 9.5 x 9.5 mm hole	001343729	0,004	10

AN-KFH cage nuts for 0.7 - 1.6 mm thick sheet metal



Cage nuts for vertical WD-K supports

Type	Description	Code nr	Weight (kg)	Packaging (pcs)
AN-KFH 8x13 M6	M6 cage nut inserted from the front to the 8 x 13 mm hole	001343730	0,003	10
AN-KFH 10.5x16.5 M8	The M8 cage nut is inserted from the front to the 10.5 x 16.5 mm hole	001343731	0,008	10

AN-KFH cage nuts for 2 - 2,1 mm thick sheet metal

Dimensional drawings

UW-SEP dividing elements and internal set brackets with UW-BCR mounting depth adjustment

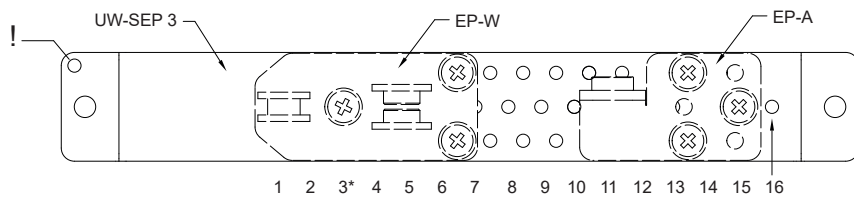
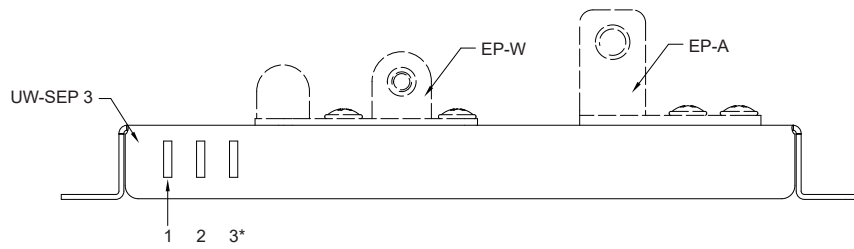
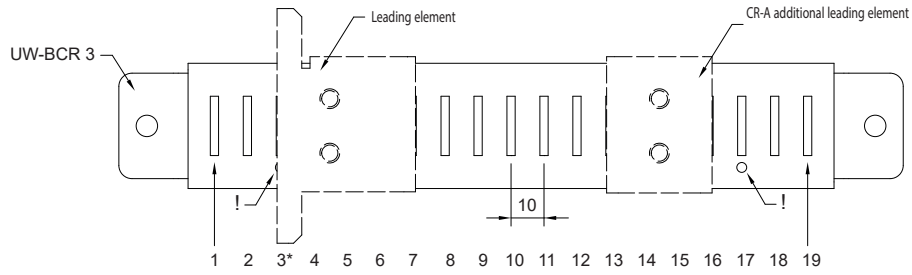

* basic mounting position of the internal set for UW-BCR 3, the distance between the covers and the enclosure door is 80 mm
! - position marker

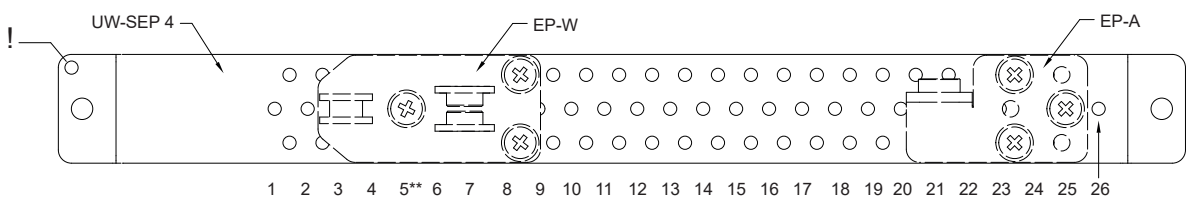
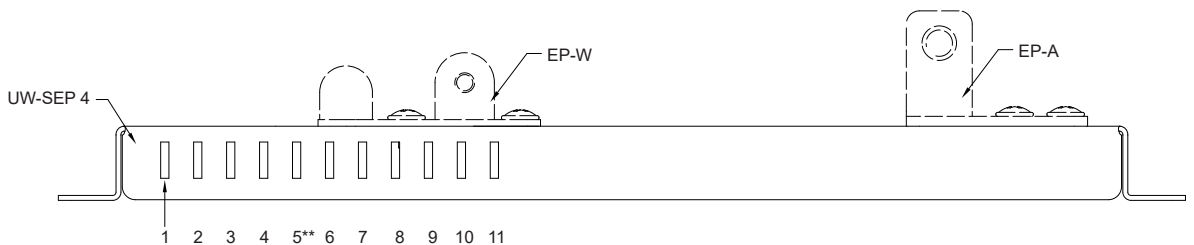
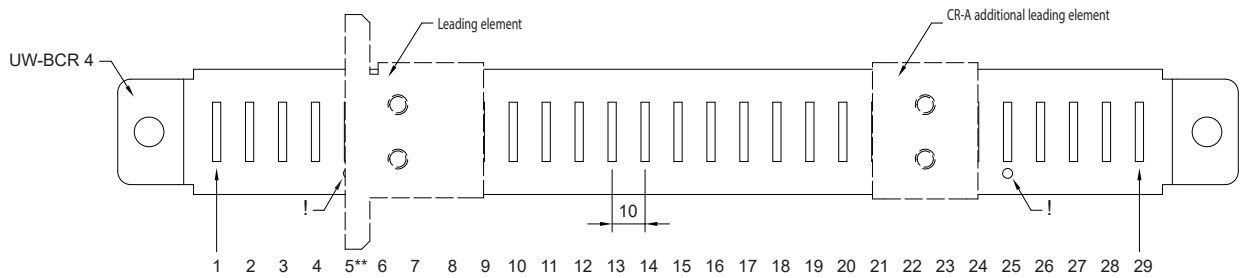

* basic mounting position of the internal set for UW-BCR 4, the distance between the covers and the enclosure door is 100 mm
! - position marker

Fixing elements LG-V and LG-T

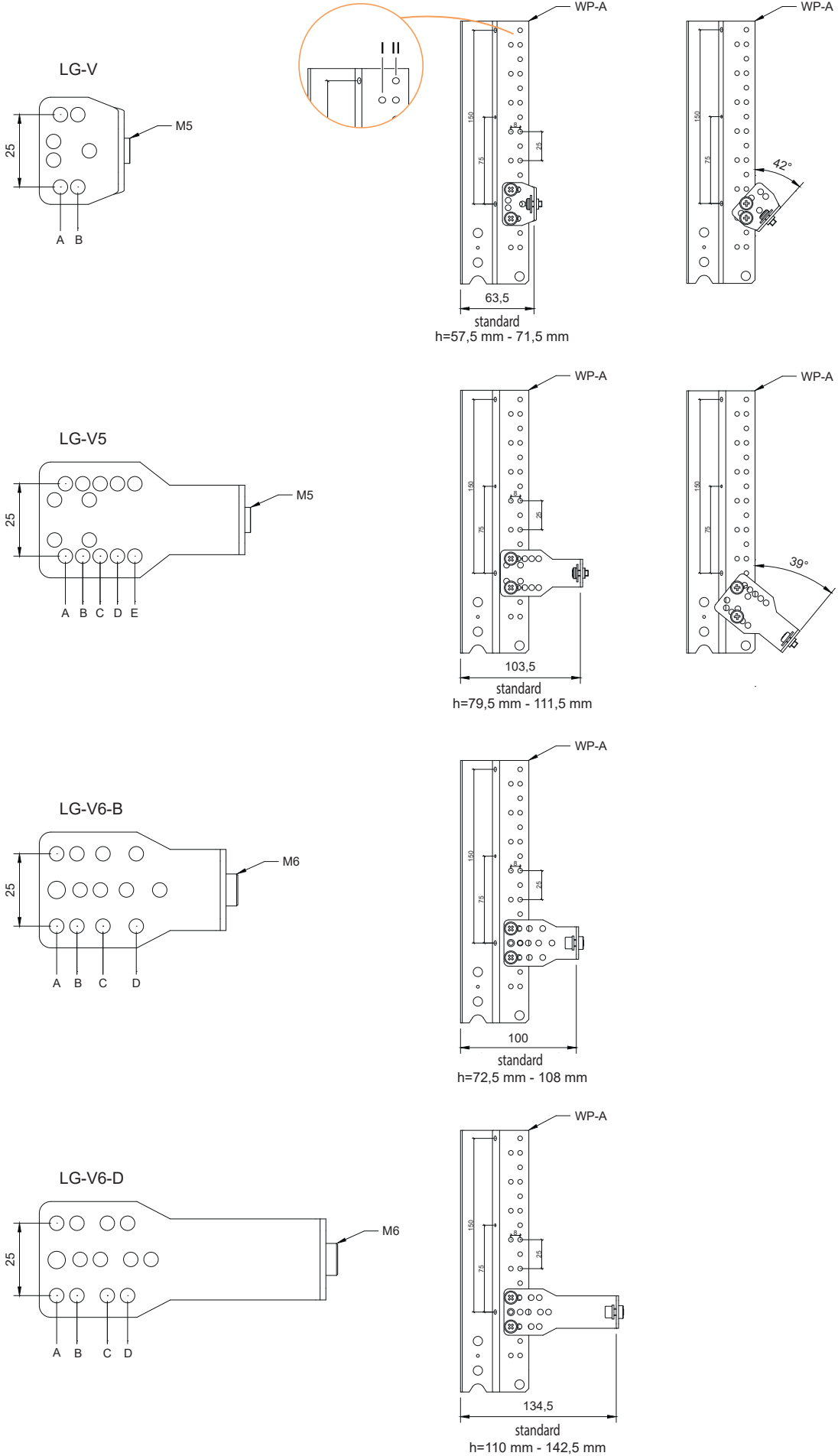

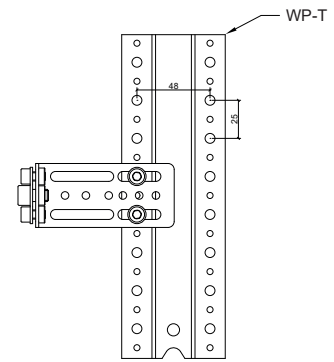
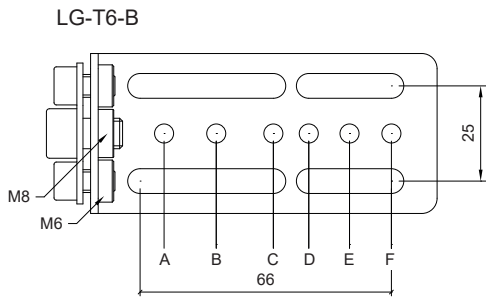
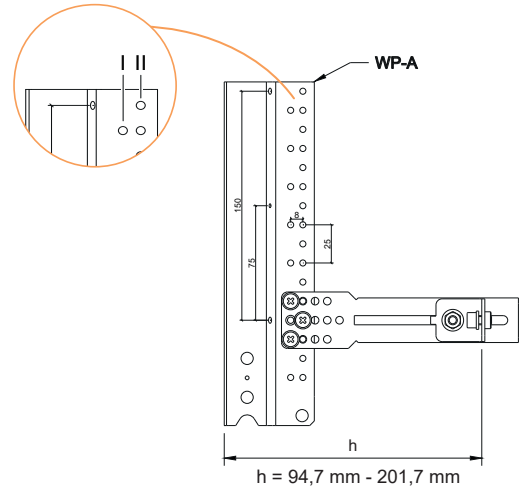
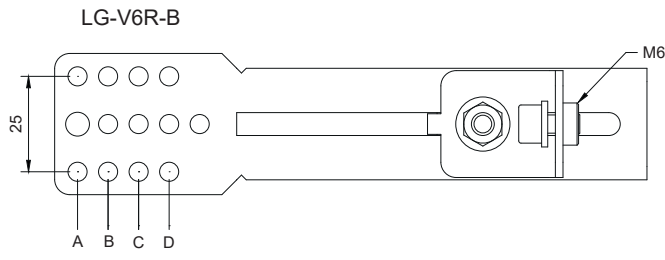

Holders for attaching enclosures to walls

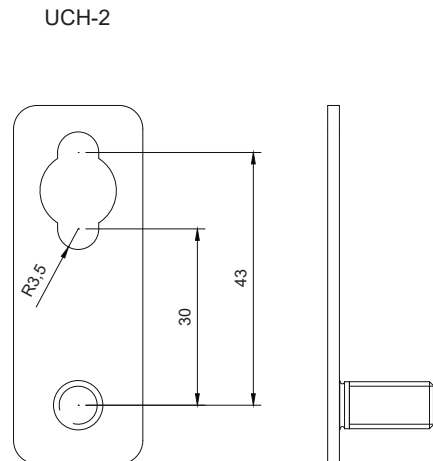
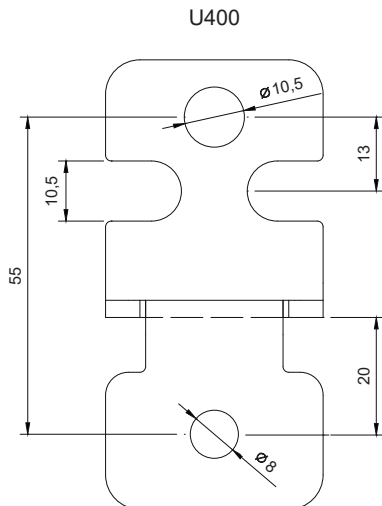

Examples of enclosures configurations with internal sets

Example 1. 4XP160 2-4 flush enclosure with economical internal set for modular equipment

4XP160 flush mounted enclosure with IP42 protection (it is possible to increase it to IP44 by appropriate gluing SEAL-G9 gasket), width 610 mm, height 710 mm, depth 160 mm. The enclosure is adapted for the assembly of devices with a total number of 96 modules. The WP-U bracket used is an economical version without the possibility to adjust the TH-S mounting rails at depth and without the possibility of dividing the enclosure vertically. Please note that AST 4.8x9.5 self-tapping screws needed for fixing TH-S rails and PM mounting plates are sold in sets of 200 pieces. For the following order 8 pieces of self-tapping screws are needed.

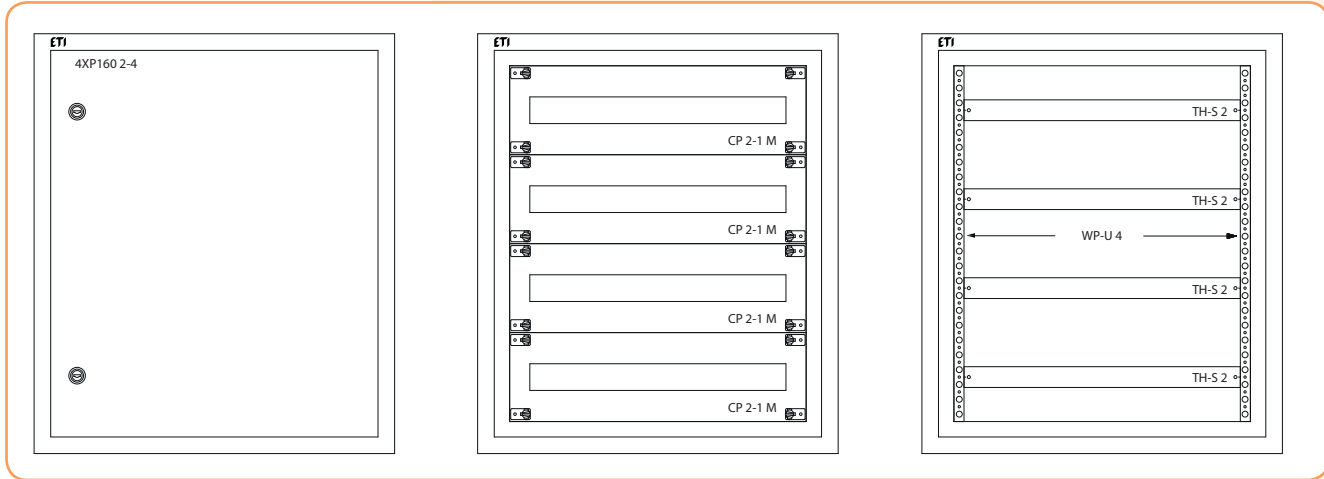

List of 4XP160 2-4 flush-mounted enclosure with economical internal set for modular equipment

No.	Type	Product name	Code no.	Quantity to order
1	4XP160 2-4	Empty flush mounted enclosure, IP42, class I RAL7035 (610x710x160)	001101411	1
2	WP-U 4	Vertical bracket 1 position U type (600) (1 set = 2 pcs.)	001101668	1
3	CP 2-1 M	Modular cover 24 mod. (500x150)	001101453	4
4	TH-S 2	Steel mounting rail 35/15 1.5 465 mm (500)	002911042	4
5	AST 4.8x9.5 SET	Self-tapping screw PH2 (1 set = 200 pcs.)	001101686	1

Example 2. Wall mounted enclosure 4XN 160 2-6 with internal set for modular equipment

4XN160 wall mounted enclosure with IP41 protection (it is possible to increase it to IP44 by appropriate gluing SEAL-G9 gasket), width 550 mm, height 950 mm, depth 160 mm. The enclosure is adapted for the assembly of devices with a total number of 144 modules. Thanks to the vertical WP-A support, TH-S rails can be adjusted to a depth.

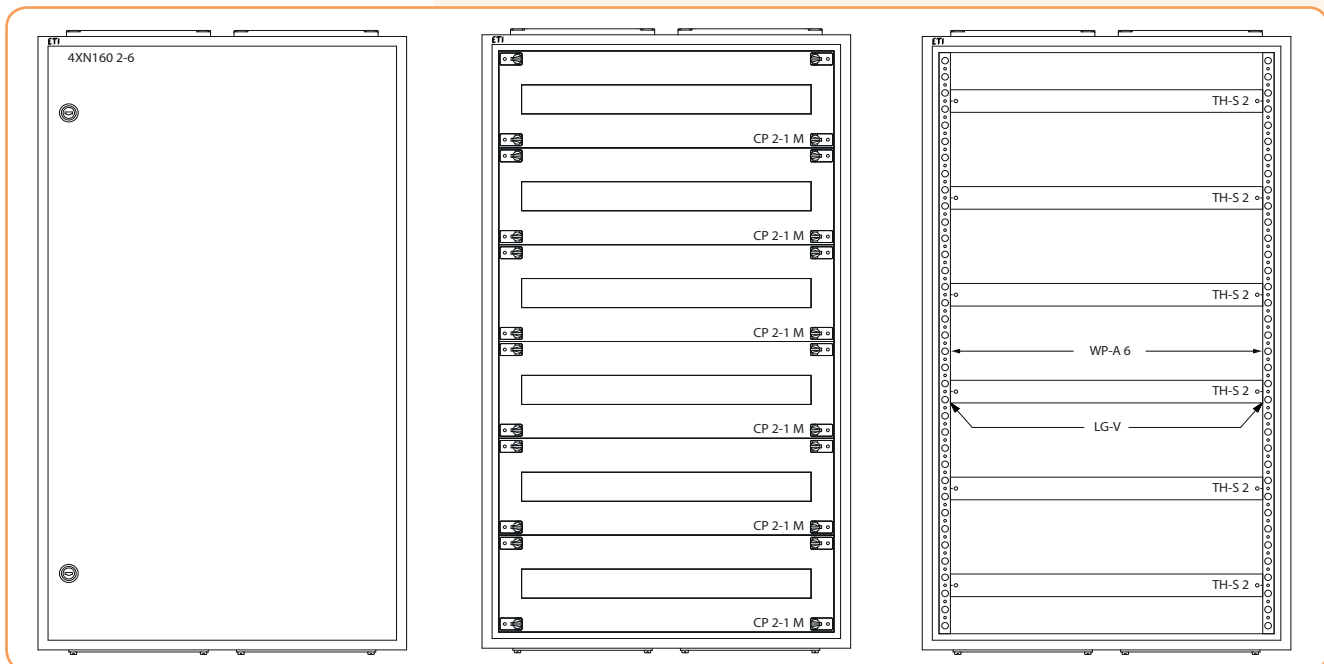

List of wall mounted enclosure 4XN160 2-6 with internal set for modular equipment

No.	Type	Product name	Code no.	Quantity to order
1	4XN160 2-6	Empty wall mounted enclosure, IP41, class I RAL7035 (550x950x160)	001101403	1
2	WP-A 6	Vertical support 3 position type A (900) (1 set = left and right)	001101648	1
3	CP 2-1 M	Modular cover 24 mod. (500x150)	001101453	6
4	TH-S 2	Steel munting rail 35/15 1.5 465 mm (500)	002911042	6
5	LG-V SET	Fixing element (1 set = 2 pcs.)	001101683	6

Example 3. Wall mounted enclosure 4XN160 3-7 with internal set for modular equipment, MCCB's / disconnectors EB / ED 125, 160, 250 A

4XN160 wall mounted enclosure with IP41 protection (it is possible to increase it to IP44 by appropriate gluing SEAL-G9 gasket), width 800 mm, height 1100 mm, depth 160 mm. The enclosure is suitable for mounting equipment with a total number of 252 modules. In the following configuration, the enclosure is suitable for mounting 156 modules, 1 disconnector / MCCB ED / EB 125, 160, 250 A, perforated mounting plate for teletechnics. The enclosure is divided vertically into a field with a width of 1 (250 mm) and 2 (500 mm). Thanks to the use of the WP-A, vertical support it is possible to adjust the rails to a depth. The enclosure is mounted on the wall using UCH-2 brackets.

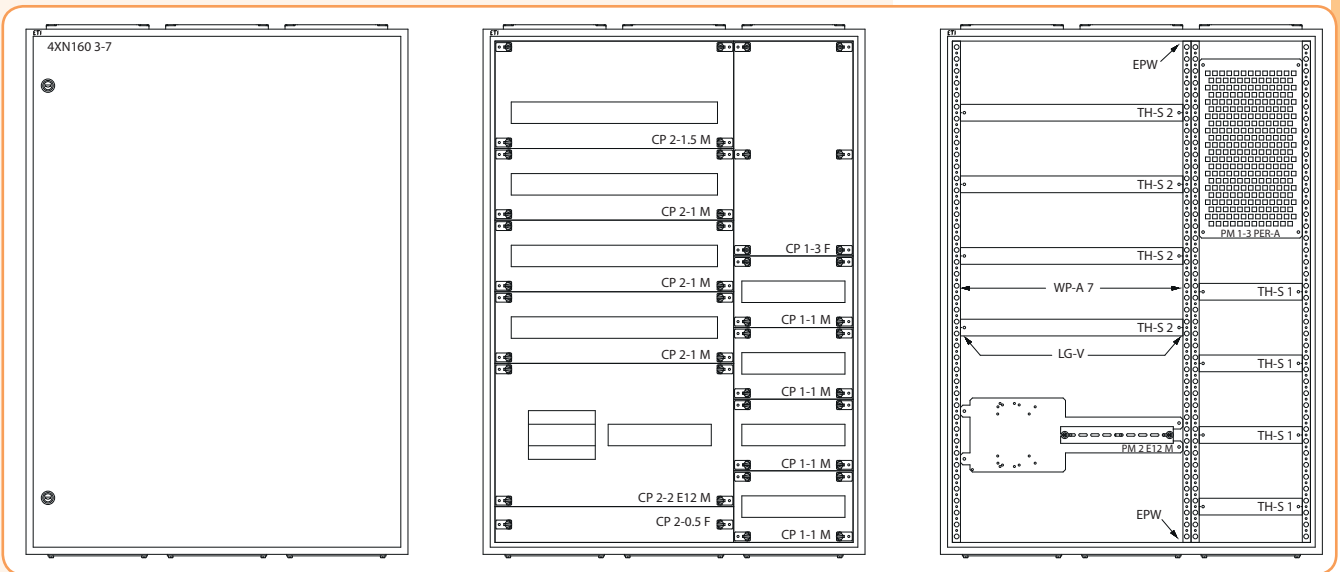

List of wall mounted enclosure 4XN160 3-7 with internal set for modular equipment, MCCB's / disconnectors EB / ED 125, 160, 250 A

No.	Type	Product name	Code no.	Quantity to order
1	4XN160 3-7	Empty wall mounted enclosure, IP41, class I RAL7035 (800x1100x160)	001101409	1
2	CP 1-1 M	Modular cover 12 mod. (250x150)	001101451	4
3	WP-A 7	Vertical support 3 position type A (1050) (1 set = left and right)	001101650	2
4	CP 1-3 F	Full cover (250x450)	001101443	1
5	CP 2-0.5 F	Full cover (500x75)	001101426	1
6	CP 2-1 M	Modular cover 24 mod. (500x150)	001101453	3
7	CP 2-1.5 M	Modular cover 24 mod. (500x225)	001101459	1
8	CP 2-2 E12 M	1xEB2 / ED2 cover 125.160.250 A 3.4P and 12 mod. (500x300)	001101483	1
9	EPW	Dividing element of the enclosure (1 set = 2 pcs.)	001101677	1
10	PM 1-3 PER-A	Perforated mounting plate type A (250)	001101622	1
11	PM 2 E12 M	1xEB2 / ED2 mounting plate with TH35 rail for 12 mod. (500)	001101572	1
12	TH-S 1	Steel mounting rail 35/15 1.5 215 mm (250)	002911040	4
13	TH-S 2	Steel mounting rail 35/15 1.5 465 mm (500)	002911042	4
14	UCH-2	Holder for hanging the enclosure (1 set = 2 pcs)	001101715	1
15	LG-V SET	Fixing element (1 set = 2 pcs)	001101683	12

Example 4. GT 100-60-25 wall mounted enclosure with a internal set

GT housing with protection class IP66, height 1000 mm, width 600 mm, depth 250 mm with mounting plate and internal set for modular equipment and disconnectors, MCCB's, fuse-links disconnectors. The following set allows installing electrical equipment with a total number of 66 modules and 4 NH00 fuse-links disconnectors, 1 ED / EB disconnector / MCCB 125, 160, 250 A. It is also possible to install the devices directly on the GT enclosure mounting plate under the internal set (two mounting levels).

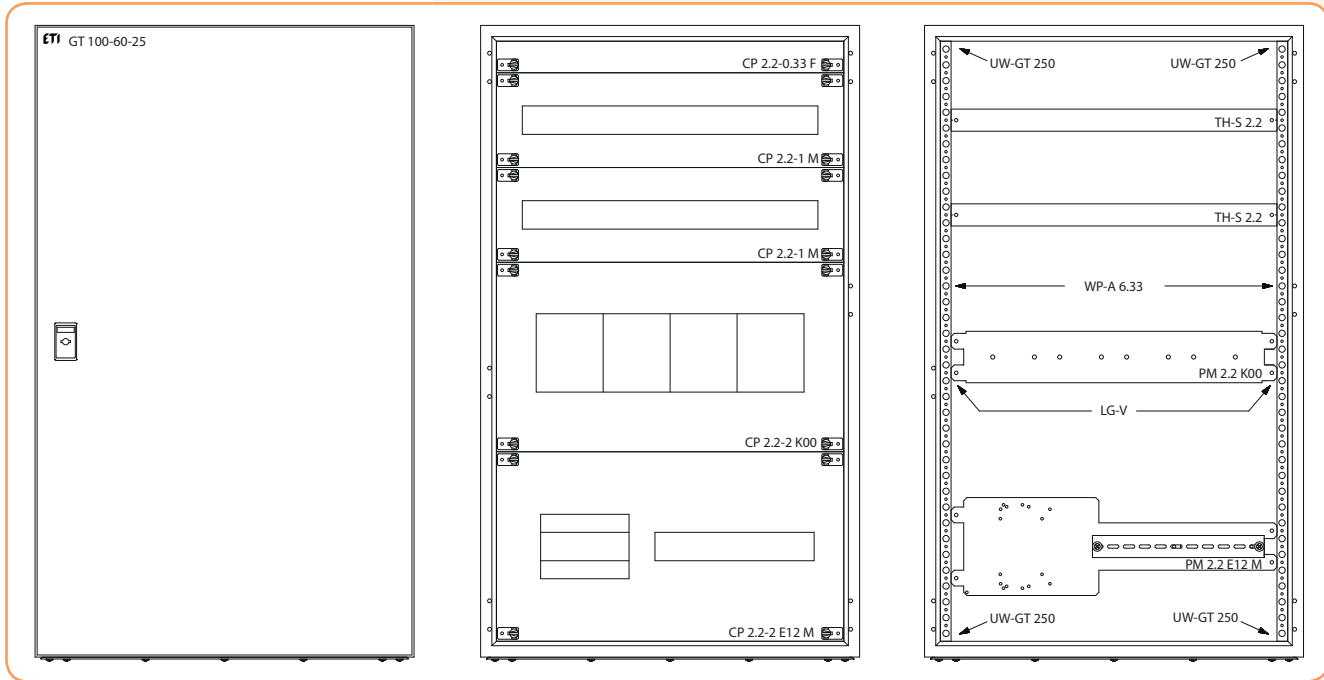

A list of a GT 100-60-25 wall mounted enclosure with a internal set

No.	Type	Product name	Code no.	Quantity to order
1	GT 100-60-25	IP66 hermetic enclosure	001102142	1
2	UW-GT 250	Internal set bracket for the GT enclosure with a depth of 250 mm (1 set = 4 pcs.)	001101707	1
3	WP-A 6.33	Vertical support 3 position type A (950) (1 set = left and right)	001101649	1
4	CP 2.2-1 M	Modular cover 26 mod. (550x150)	001101454	2
5	CP 2.2-2 K00	Cover 4xK00 (550x300)	001339503	1
6	CP 2.2-2 E12 M	1xE12 / ED2 125,160,250 A 3,4P cover and 14 mod. (550x300)	001101484	1
7	CP 2.2-0.33 F	Full cover (550x50)	001101422	1
8	TH-S 2.2	Steel mounting rail 35/15 1.5 515 mm (550)	002911043	2
9	PM 2.2 K00	Mounting plate 4xK00 (550)	001340553	1
10	PM 2.2 E12 L12	Mounting plate 2xE12 / ED2 125,160,250 A 3,4P or 2xLA1,2 (550)	001101587	1
11	LG-V SET	Fixing element (1 set = 2 pcs)	001101683	6

REMEMBER!

- In order to mount the internal set with the electrical equipment in GT enclosures, additional UW-GT brackets should be purchased.
- Depth adjustment of the internal set is possible in GT enclosures with a depth of 300 and 400 mm.
- When replacing the lock with a different one, select the type and number of locks depending on the type of GT enclosure.

Example 5. HXS300 3-12 standing enclosure with mounting plate

HXS300 3-12 PH1 standing enclosure with IP65 protection, height 1950 mm (including 100 mm plinth), width 800 mm and depth 300 mm. In the following configuration, the enclosure is equipped with a mounting plate with a width of 3 (750 mm) and a height of 12 (1800 mm) on UA-B brackets (mounting plate on the back of the enclosure without the possibility of adjusting the depth).

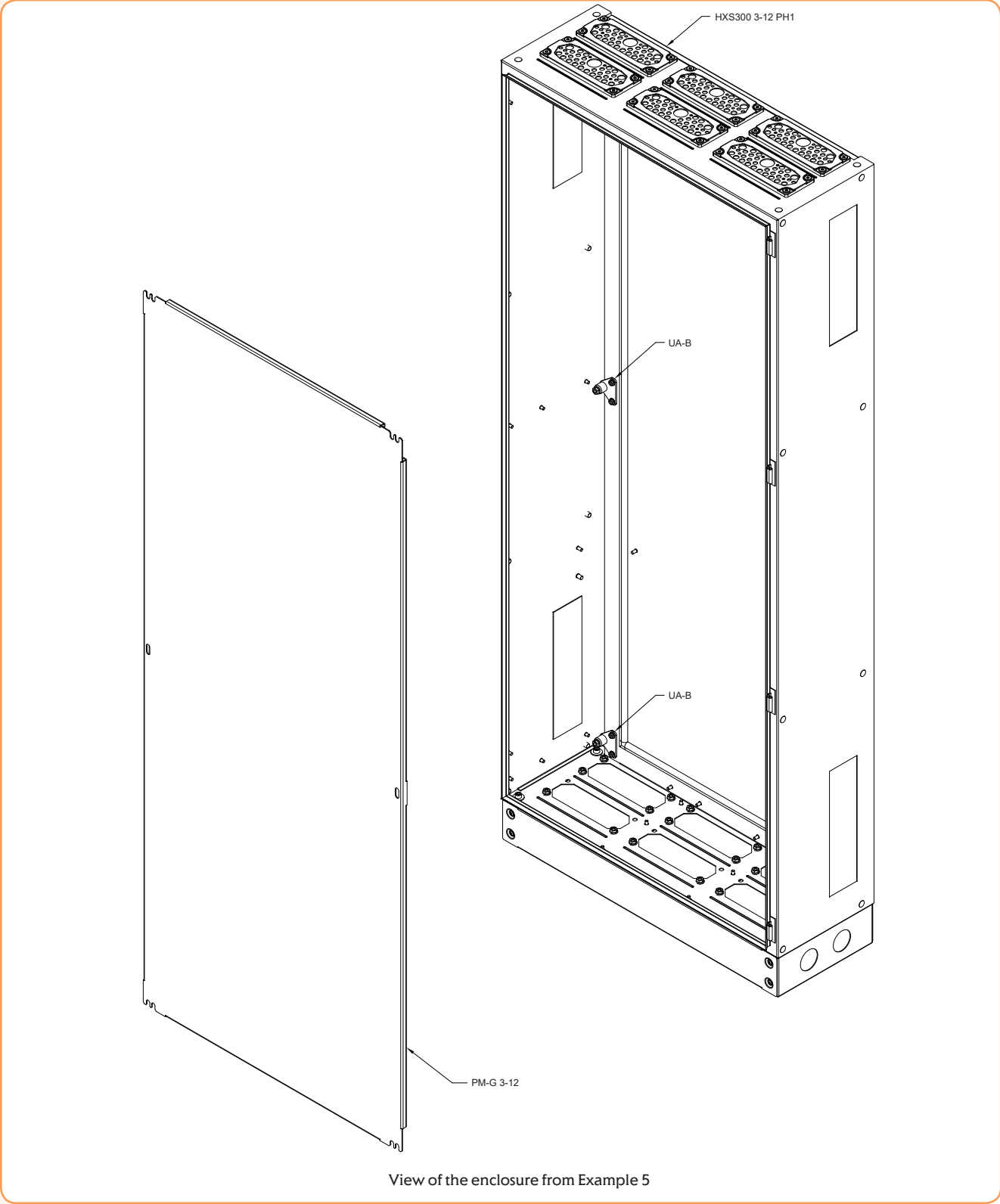

List of elements for HXS300 3-12 PH1 enclosure from example 5

No.	Type	Product name	Code no.	Quantity to order
1	HXS300 3-12 PH1	Empty standing enclosure, IP65, class I RAL7035 (800x1850x300) with 100 mm plinth	001325103	1
2	UA-B	Side handle for PM-G plates mounted on the back of the housing (1 set = 2 pcs)	001338102	3
3	PM-G 3-12	Mounting plate with a height of 12 (1800) and a width of 3 (750)	001337967	1

Example 6. HXS300 2-12 PH1 standing enclosure with internal set for modular equipment, EB2 / ED2 125 / 160 / 250 A MCCB's / disconnectors and for NHL KVL disconnectors

HXS300 2-12 PH1 standing enclosure with IP65 protection, 1950 mm height (including 100 mm plinth), width 550 mm and depth 300 mm. In the following configuration, the enclosure is designed for mounting 124 modules, 5 KVL NH00 fuse-links disconnectors and 1 ED2 / EB2 125, 160, 250 A disconnector / MCCB. The enclosure is divided horizontally into compartments with a height of 7 and 5, additionally the bottom part is divided vertically into 2 fields with a width of 1 (250 mm). Thanks to the use of the WP-A vertical support it is possible to adjust the TH-S rails at depth. The UW-BCU 23 internal set bracket has two mounting depths (60 mm or 80 mm from the covers to the enclosure door).

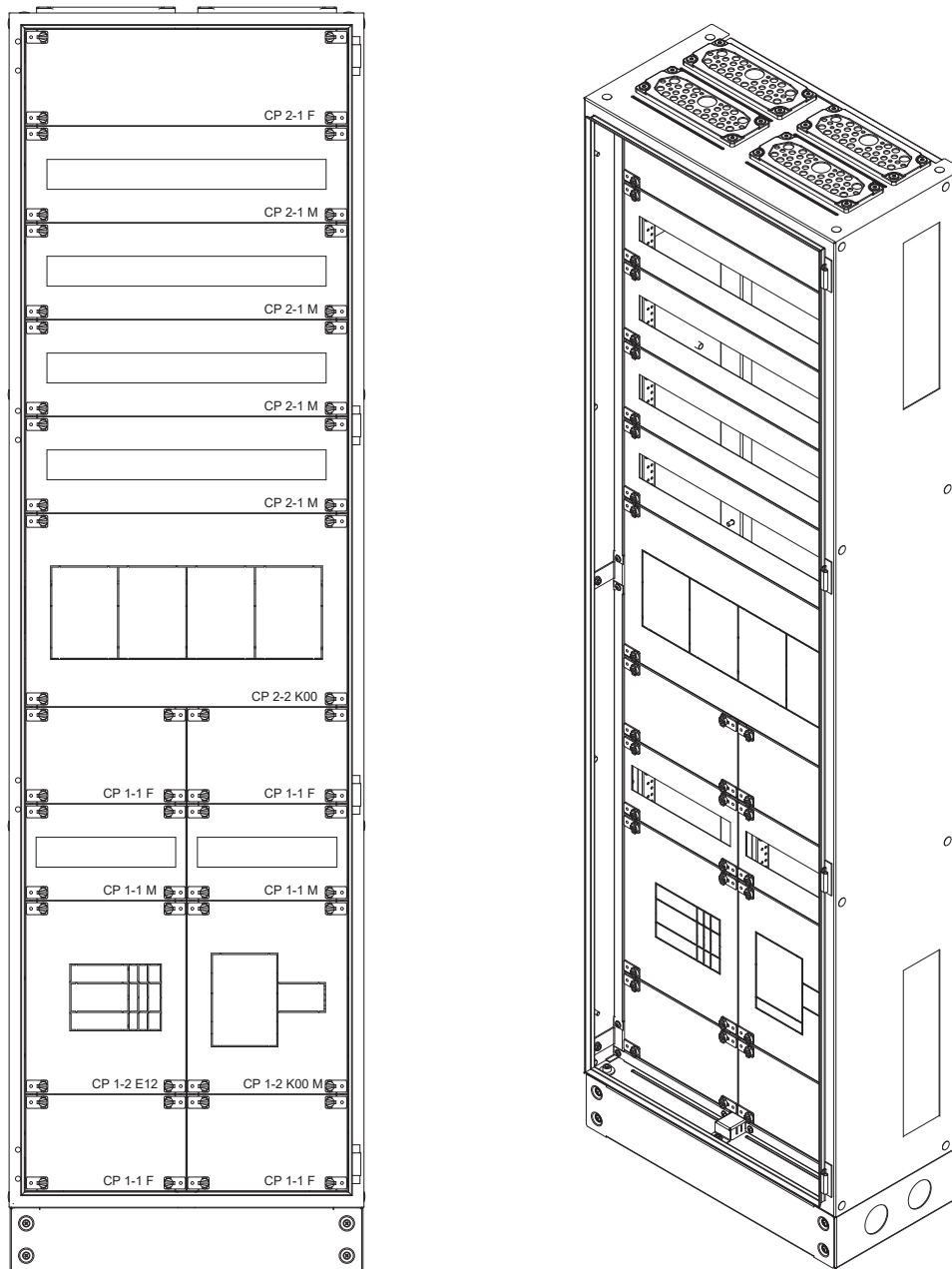

Elevation view and isometric view of the enclosure from Example 6

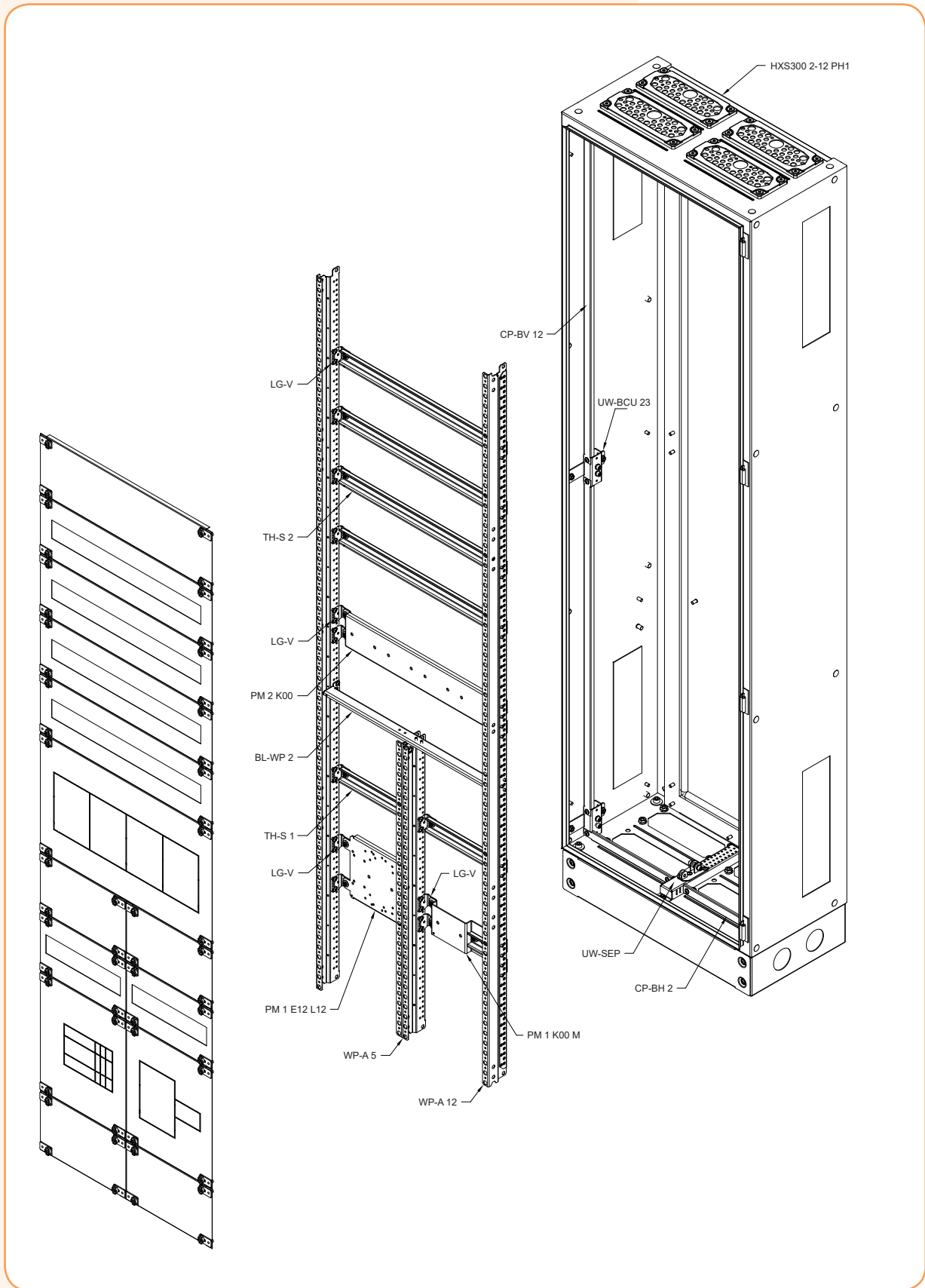

View of the decomposed enclosure from example 6

List of elements for enclosure HXS300 2-12 PH1 from example 6

No.	Type	Product name	Code no.	Quantity to order
1	HXS300 2-12 PH1	Empty standing enclosure, IP65, class I RAL7035 (550x1850x300) with 100 mm plinth	001325102	1
2	UW-BCU 23	Internal set bracket 2 position for HXS enclosures with a depth of 300 mm (1 set = 2 pcs.)	001338201	3
3	UW-SEP 3	Dividing support for HXS enclosures with a depth of 300 mm	001338302	1
4	EP-W	Dividing element of the enclosure (1 set = 2 pcs.)	001101677	1
5	WP-A 5	Vertical support 3 position type A (750) (1 set = left and right)	001101647	1
6	WP-A 12	Vertical support, 2-position, type A (1800) (1 set = left and right)	001338605	1
7	BL-WP 2	Split bar width 2 (500) split 1: 1	001338900	1
8	LG-V SET	Fixing element (1 set = 2 pcs)	001101683	12
9	TH-S 1	Steel mounting rail 35/15 1.5 215 mm (250)	002911040	2
10	TH-S 2	Steel mounting rail 35/15 1.5 465 mm (500)	002911042	4
11	PM 1 E12 L12	Mounting plate 1xEB2 / ED2 125,160,250A 3,4P or 1xLA1,2 (250)	001101584	1
12	PM 1 K00 M	1xKVL00 cover and 4 mod. (250x300)	001340500	1
13	PM 2 K00	Mounting plate 4xKVL00 (500)	001340552	1
14	CP 2-1 F	Full cover (500x150)	001101431	1
15	CP 2-1 M	Modular cover 24 mod. (500x150)	001101453	4
16	CP 2-2 K00	Cover 4xKVL00 (500x300)	001339502	1
17	CP 1-1 F	Full cover (250x150)	001101429	4
18	CP 1-1 M	Modular cover 12 mod. (250x150)	001101451	2
19	CP 1-2 E12	Cover 1xEB2 / ED2 125.160.250A 3.4P (250x300)	001101514	1
20	CP 1-2 K00 M	Cover for 1xKVL00 and 4 mod. (250x300)	001339450	1
21	CP-BV 12	Side additional covers for HXS enclosures, height 12 (1800) (1 set = 4 pcs.)	001340164	1
22	CP-BH 2	Horizontal upper and lower additional covers, divided, for HXS enclosures, width 2 (500) (1 set)	001340200	1

REMEMBER!

- In order to install the internal set with the electrical equipment in the HXS enclosures, you should buy the UW-BCU or UW-BCR brackets.
- With the simultaneous division of the (width 3 - 750 mm) internal set vertically and horizontally (BL-WP 3), make sure that the bottom section is divided into 2 + 1, 1 + 2 or 1 + 1 + 1. The use of BL WP 3 divider bar without providing at least one division in the bottom section is not allowed.

Example 7. HXS300 3-12 PH1 standing enclosure with mounting internal set for modular equipment, MCCB / disconnecter EB2 / ED2 125, 160, 250 A, KVL NH00 fuse-links disconnectors, with busbar set and with PM-G 1-12 mounting plate mounted on brackets without depth adjustment

HXS300 3-12 PH1 standing enclosure with IP65 protection, 1950 mm (including 100 mm plinth), width 800 mm and depth 300 mm. In the following configuration, the enclosure is suitable for mounting 69 modular devices (18 mm), 3 KVL NH00 disconnectors, 1 MCCB / disconnecter ED2 / EB2 125, 160, 250 A. In addition, the enclosure is equipped with a mounting plate with a width of 1 (250 mm) and height of 12 (1800 mm). The enclosure is divided into two sections, the first section with a width of 1 (250 mm) with the mounting plate on the supports without the possibility of depth adjustment and the second section for the internal set for the electrical equipment. The internal set with the equipment was additionally divided horizontally into fields with a height of 3, 5 and 4. The lower and upper part was divided vertically into 2 fields with a width of 1 (250 mm). Thanks to the use of the WP-A support, it is possible to adjust the TH S rails to a depth. The UW-BCR 3 mounting element enables step adjustment of the insertion depth of the entire internal set (60 mm - 240 mm from covers to the enclosure door). In addition, the internal set is equipped with supports for insulating busbar carriers with a 60 mm spacing mounted on WP-A vertical supports.

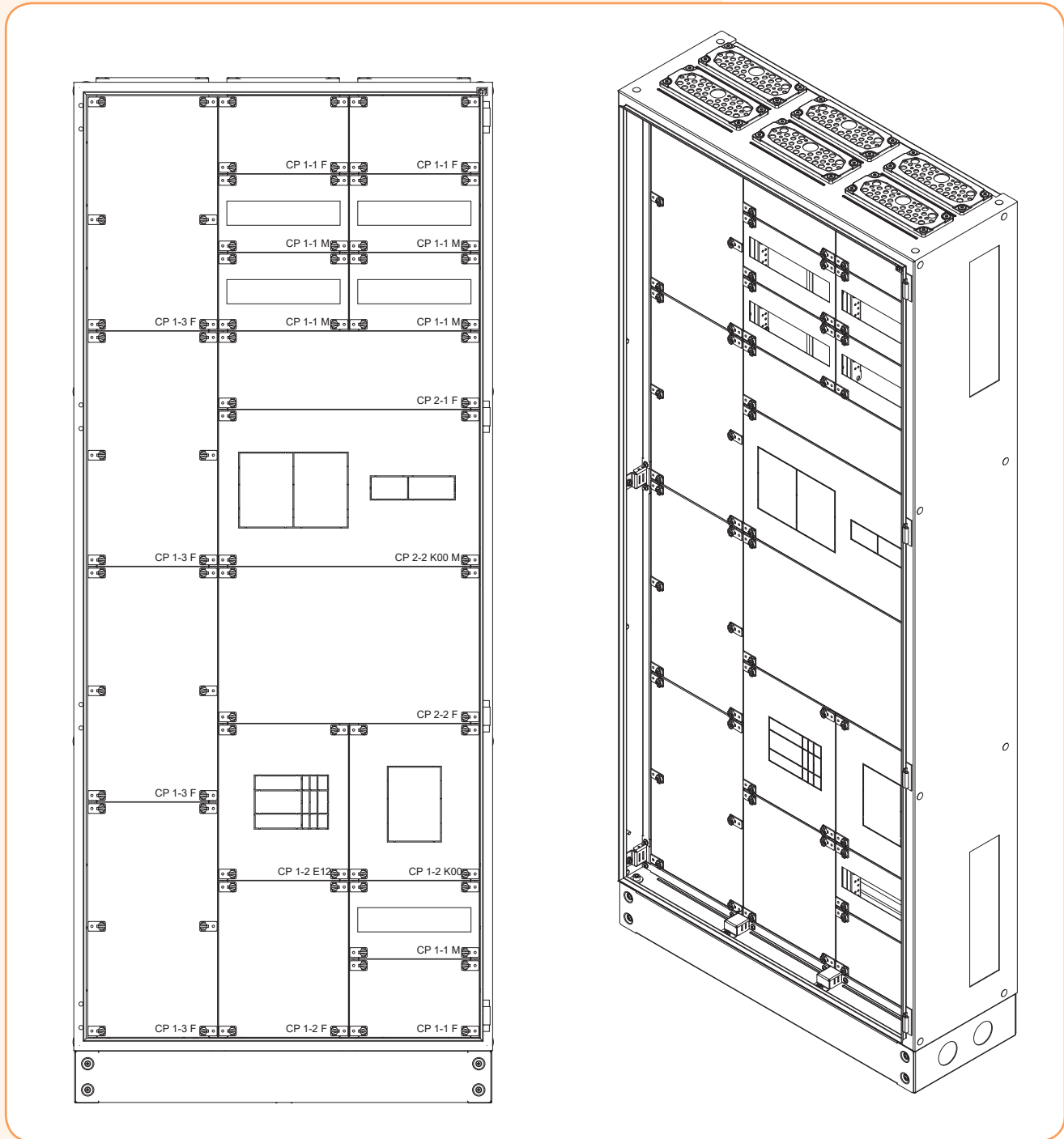

Elevation view and isometric view of the enclosure from Example 7

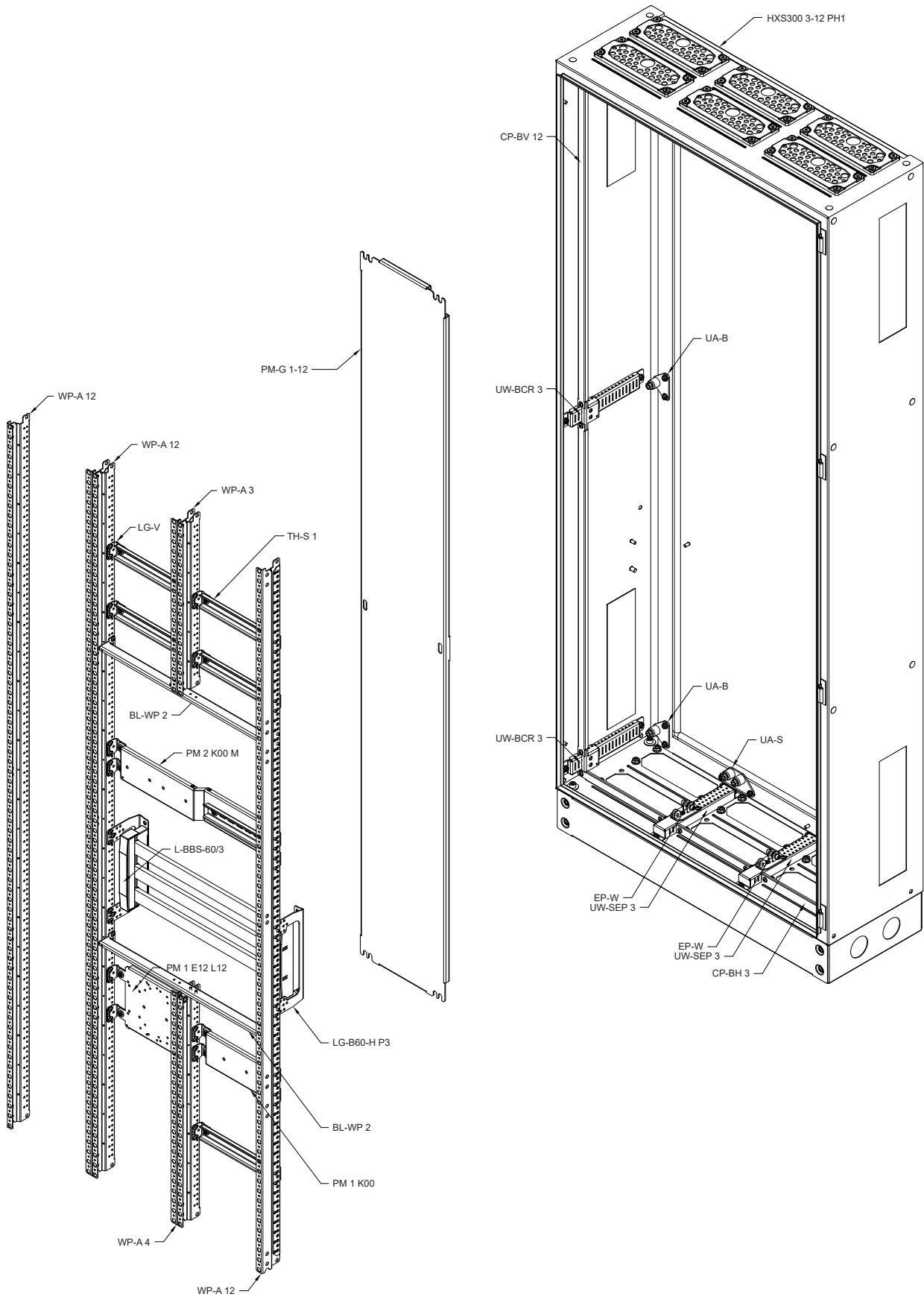

View of the decomposed enclosure from example 7

List of elements for enclosure from example 7

No.	Type	Product name	Code no.	Quantity to order
1	HXS300 3-12 PH1	Empty standing enclosure, IP65, class I RAL7035 (800x1850x300) with 100 mm plinth	001325103	1
2	UW-BCR 3	Adjustable internal set bracket for HXS enclosures, 300 mm deep (1 set = 2 pcs)	001338206	3
3	UW-SEP 3	Dividing support for HXS enclosures with a depth of 300 mm	001338302	4
4	EP-W	Dividing element of the enclosure (1 set = 2 pcs.)	001101677	2
5	UA-B	Side bracket for PM-G plates mounted on the back of the enclosure (1 set = 2 pcs)	001338102	2
6	UA-S	Center bracket for PM-G plates and WD supports mounted on the back of the enclosure (1 set = 2 pcs)	001338104	1
7	WP-A 3	Vertical support, 2-position, type A (450) (1 set = left and right)	001101644	1
8	WP-A 4	Vertical support, 2 position type A (600) (1 set = left and right)	001101646	1
9	WP-A 12	Vertical support, 2-position, type A (1800) (1 set = left and right)	001338605	2
10	BL-WP 2	Dividing bar width 2 (500) division 1: 1	001338900	2
11	LG-V SET	Fixing element (1 set = 2 pcs)	001101683	11
12	TH-S 1	Steel mounting rail 35/15 1.5 215 mm (250)	002911040	5
13	PM 2 K00 M	Cover 2xKVL00 and 9 mod. (500x300)	001340502	1
14	PM 1 E12 L12	Mounting plate 1xEB2 / ED2 125,160,250A 3,4P or 1xLA1,2 (250)	001101584	1
15	PM 1 K00	Mounting plate 1xKVL00 (250)	001340550	1
16	PM-G 1-12	Mounting plate with a height of 12 (1800) and width 1 (250)	001337963	1
17	LG-B60-H P3	Bracket with 3-pole BBS carrier	001341651	2
18	L-BBS-60/3	Side insulation cover for 3-pin BBS carrier	001696006	2
19	CP 1-1 F	Full cover (250x150)	001101429	3
20	CP 2-1 F	Full cover (500x150)	001101431	1
21	CP 1-1 M	Modular cover 12 mod. (250x150)	001101451	5
22	CP 2-2 K00 M	Cover 2xKVL00 and 9 mod. (500x300)	001339452	1
23	CP 2-2 F	Full cover (500x300)	001101438	1
24	CP 1-2 E12	Cover 1xEB2 / ED2 125.160.250A 3.4P (250x300)	001101514	1
25	CP 1-2 K00	Cover 1xKVL00 (250x300)	001339500	1
26	CP 1-2 F	Full cover (250x300)	001101436	1
27	CP 1-3 F	Full cover (250x450)	001101443	4
28	CP-BV 12	Side vertical additional covers, side, left and right, for HXS enclosures, height 12 (1800) (1 set)	001340164	1
29	CP-BH 3	Divided horizontal additional covers, upper and lower, for HXS enclosures, width 3 (750) (1 set)	001340201	1

REMEMBER!

- In order to mount the PM-G in empty HXS enclosures, the UA-B brackets should be purchased, and if the plate width is smaller than the width of the enclosure, the UA-S handles should be additionally purchased.
- BL-UA stiffening bars provide additional support points for PM-G mounting plates.
- When dividing the internal set, attention should be paid to maintaining adequate insulation distances between the electrical equipment and the components, especially the distance to the BL-WP dividing bar. The bar can be turned over by 180° and assembled depending on needs from the top or bottom of the WP-A vertical support .

Example 8. HXS300 4-12 PH1 standing enclosure with internal set for modular equipment, EB2 / ED2 MCCB's and disconnectors, and SL strip type fuse-switch disconnectors

HXS300 4-12 PH1 standing enclosure with IP65 protection, 1950 mm height (including 100 mm plinth), 1050 mm width and 300 mm depth. In the following configuration, the enclosure is adapted for the assembly of 192 modules, 2 disconnectors / MCCB's ED2 / EB2 400, 630 A and 8 strip type fuse-switch disconnectors SL NH00 or 4 strip type fuse-switch disconnectors SL NH 1,2,3. In the enclosures, both WP-A, WP-T vertical supports and WD-K supports were used, on which a 185 mm busbars was mounted for the assembly of SL strip type fuse-switch disconnectors. The entire internal set is mounted on brackets that allow you to adjust the depth of the internal set. The heavier equipment was mounted on WP-T vertical supports. The busbars are mounted on WP-A and WD-K supports on the back of the enclosure.

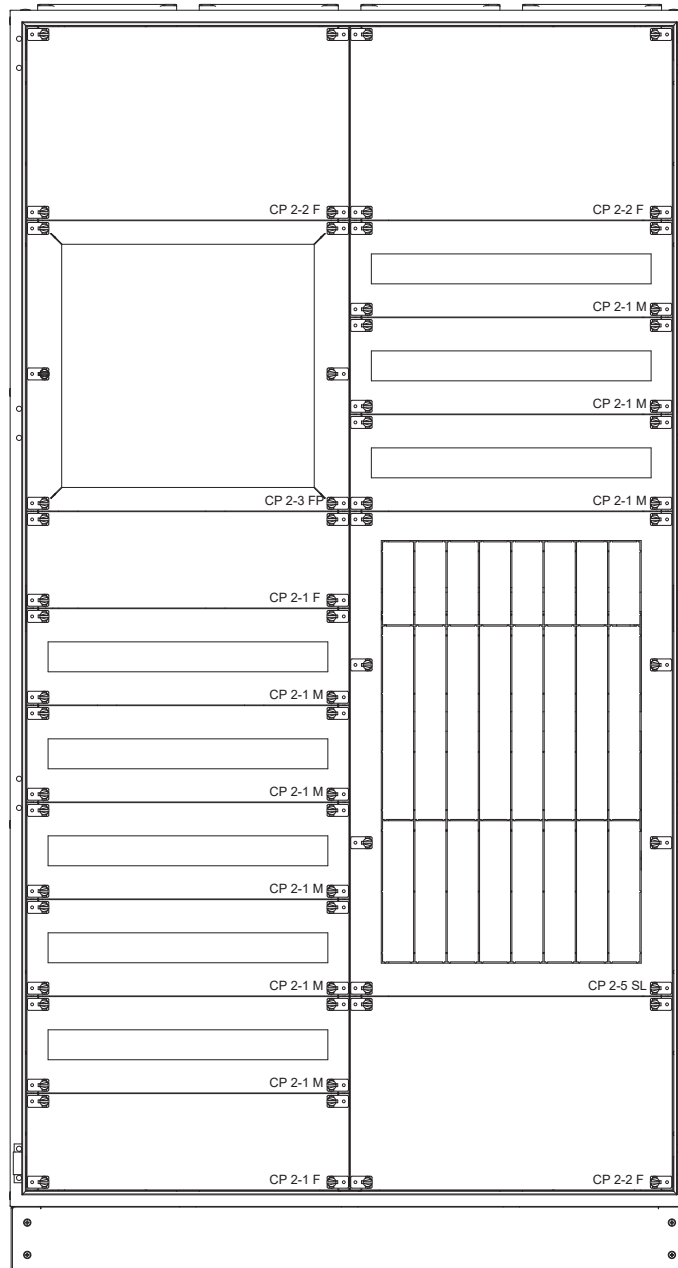

Elevation view of the enclosure of Example 8

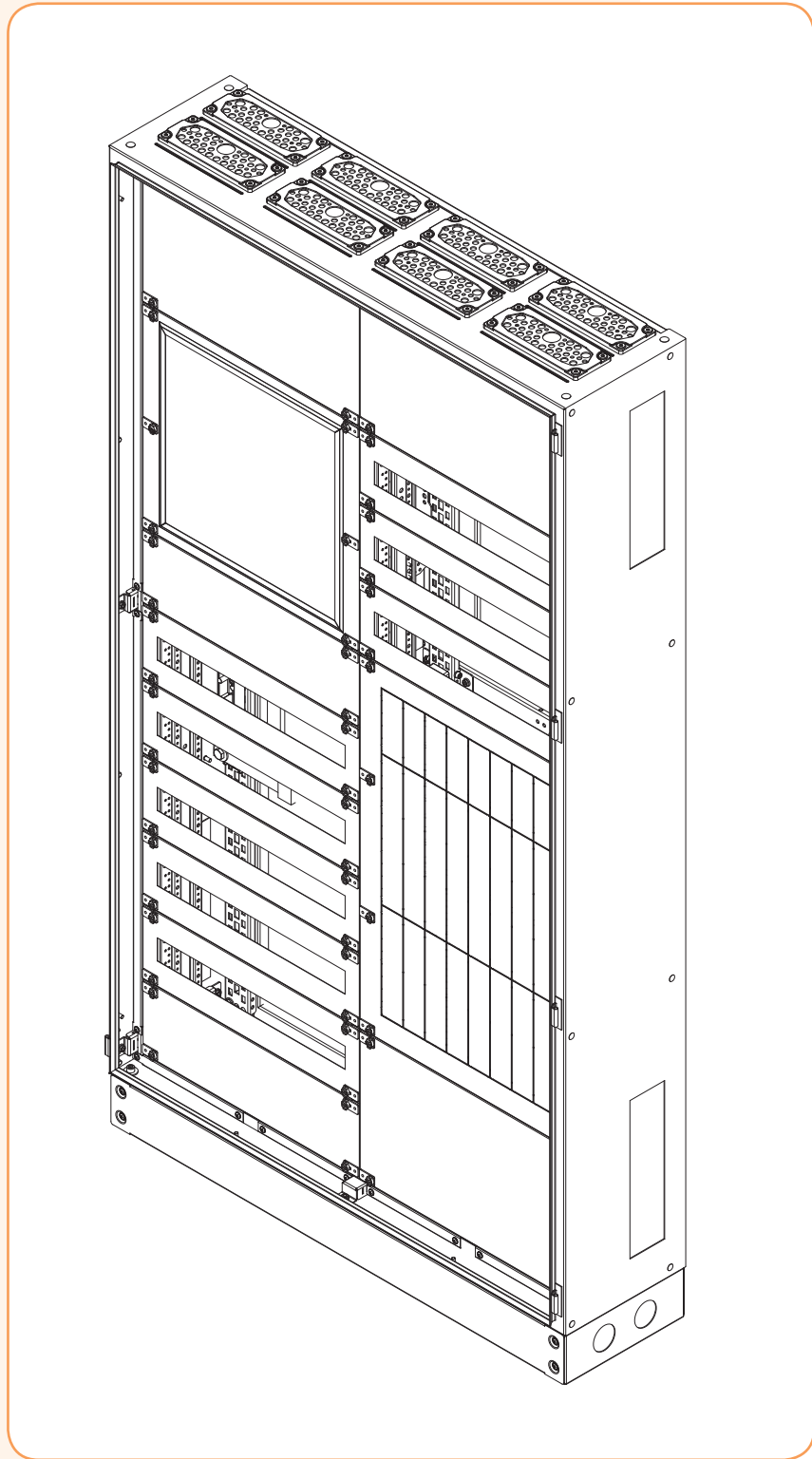

Isometric view of the enclosure from Example 8

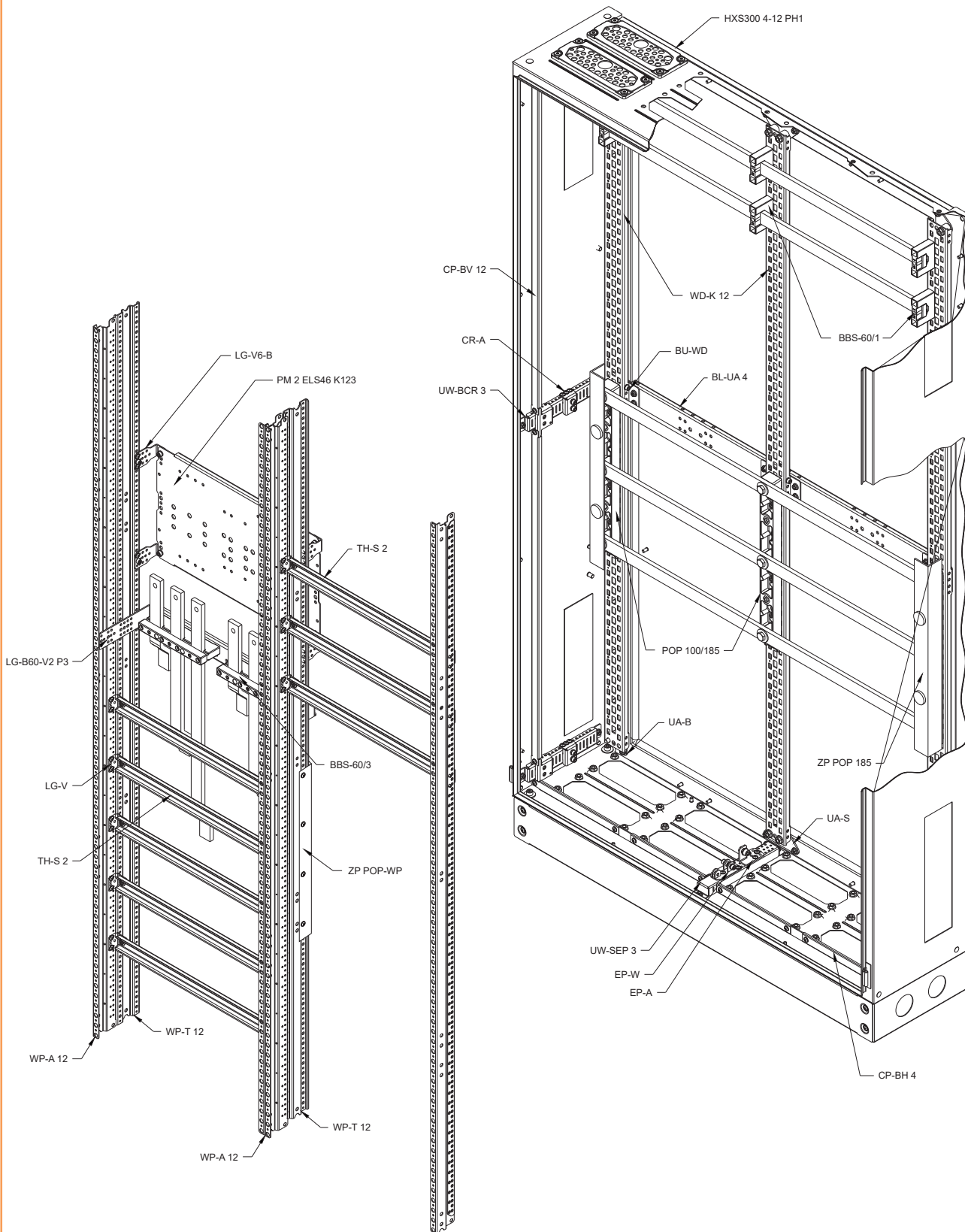

View of the decomposed enclosure from example 7

List of elements for enclosure HXS300 4-12 PH1 from example 8

No.	Type	Product name	Code no.	Quantity to order
1	HXS300 4-12 PH1	Empty enclosure, IP55, class I RAL7035 (1050x1850x300) with 100 mm plinth	001325104	1
2	WP-A 12	Vertical support, 2-position, type A (1800) (1 set = left and right)	001338605	2
3	WP-T 12	Vertical reinforced bracket type T (1800) (1 set = 2 pcs)	001338764	1
4	WD-K 12	Vertical support type K for cage nuts (1800) (1 piece)	001338864	3
5	UW-BCR 3	Adjustable internal set bracket for HXS enclosures, 300 mm deep (1 set = 2 pcs)	001338206	3
6	UW-SEP 3	Dividing support for HXS enclosures with a depth of 300 mm	001338302	2
7	EP-W	Dividing element of the enclosure (1 set = 2 pcs.)	001101677	1
8	EP-A	Dividing element for mounting the WP-T support on the UW-SEP element (1 set = 2 pcs.)	001338306	1
9	UA-S	Center bracket for PM-G plates and WD supports mounted on the back of the enclosure (1 set = 2 pcs)	001338104	1
10	UA-B	Side bracket for PM-G plates mounted on the back of the enclosure (1 set = 2 pcs)	001338102	2
11	BL-UA 4	Stiffening bar mounted directly to the enclosure, width 4 (1000) (1 set)	001338132	1
12	BU-WD	Bracket for WD supports, fixed to a stiffening bar (1 set = 2 pcs)	001338161	2
13	CR-A	Leading element to UW-BCR without the possibility of screwing covers (1 set = 2 pcs)	001338215	3
14	LG-V SET	Fixing element (1 set = 2 pcs)	001101683	8
15	LG-V6-B SET	Fixing element with M6 nut type V6-B (1 set = 2 pcs)	001341151	3
16	PM 2 ELS46 K123	Mounting plate 2xEB2 / ED2 / LA 400, 630A 3,4P or 2xLBS 400, 630A 3P or 1xLBS 400, 630A 4P or 2xKVL1,2 or 1xKVL3 (500)	001340702	1
17	TH-S 2	Steel mounting rail 35/15 1.5 465 mm (500)	002911042	8
18	LG-B60-V2 P3	Support with 3-pole BBS carrier, width 2 (500)	001341702	1
19	BBS-60/1	Insulating busbar carrier, 1-pole	001696000	6
20	BBS-60/3	Insulation carrier for busbars with a thickness of 5 or 10 mm, 3-pole	001696001	1
21	POP 100/185	Insulation carrier for busbars with a spacing of 100 and 185 mm	001691055	3
22	ZP POP 185	Side insulation cover for POP 100/185 carrier, for busbars with 185 mm spacing	001691057	2
23	ZP POP-WP	Insulating cover for mounting between vertical supports and 100/185 mm busbar system	001342180	1
24	CP 2-1 F	Full cover (500x150)	001101431	2
25	CP 2-2 F	Full cover (500x300)	001101438	3
26	CP 2-3 PF	Universal cover with plastic filling (500x450)	001340058	1
27	CP 2-1 M	Modular cover 24 mod. (500x150)	001101453	8
28	CP 2-5 SL	Cover 8xSL00 or 4xSL1,2,3 (500x750)	001339752	1
29	CP-BV 12	Side additional covers, side, left and right, for HXS enclosures, height 12 (1800) (1 set)	001340164	1
30	CP-BH 4	Divided horizontal additional covers, upper and lower, for HXS enclosures, width 4 (1000) (1 set)	001340202	1
31	AS-SH 6x35 SET	Metric Allen screw - M6 (1 set = 10 pcs.)	001343415	2
32	AS-SH 8x16 SET	Metric Allen screw - M8 (1 set = 10 pcs.)	001343421	1
33	AN-KFH 8x13 M6	M6 cage nut inserted from the front to the 8 x 13 mm hole	001343730	12
34	AN-KFH 10.5x16.5 M8	The M8 cage nut inserted from the front to the 10.5 x 16.5 mm hole	001343731	9

REMEMBER!

- HXS 4X (1050 mm) series enclosures with double leaf doors have an IP55 protection rating.
- Dedicated UA-B-WD side brackets for WD-K vertical supports allow the installation of POP 100/185 insulating supports at any height without collision with fixing elements.
- The termination of busbars should always be secured with additional insulating covers.
- An additional BBS 60/3 carrier for the second busbar can be attached to the bracket with the LG-B60-V2 P3 isolation carrier.

Example 9. Set of two connected HXS400 3-13 enclosures with internal sets for modular equipment, EB2 / ED2 MCCB's and disconnectors, KVL disconnectors and SL strip type fuse-switch disconnectors

Set of two connected HXS400 3-13 enclosures, each with an IP65 protection, 1950 mm (without a plinth), 800 mm wide and depth 400 mm, the total width of the set is 1600 mm. In the following configuration, the enclosures are equipped with plinths with a height of 100 mm and suitable for mounting 60 modules, 5 KVL NH00 fuse-links disconnectors and 1 KVL NH1 disconnector mounted on the busbar, 2 ED2 disconnectors / EB2 MCCB's 125, 160, 250 A, 1 ED2 disconnector / EB2 MCCB 400, 630 A and 8 SL NH00 strip type fuse-switch disconnectors or 4 SL NH1,2,3 strip type fuse-switch disconnectors. The internal set ensures easy assembly and use supports with insulating carriers and busbars significantly facilitates power distribution and connection of the installed equipment. Through broken weakening in the covers of the enclosures, busbars supplying the equipment in both sections are carried out. In the enclosures WP-A vertical and WD-K supports were used, on which a 185 mm busbar was mounted for the installation of SL strip type fuse-switch disconnectors. The entire internal set is mounted on brackets that allow you to adjust its depth. The current busbars are mounted on WP-A supports and on the rear wall of the enclosure on WD-K vertical supports with BBS insulating carriers.

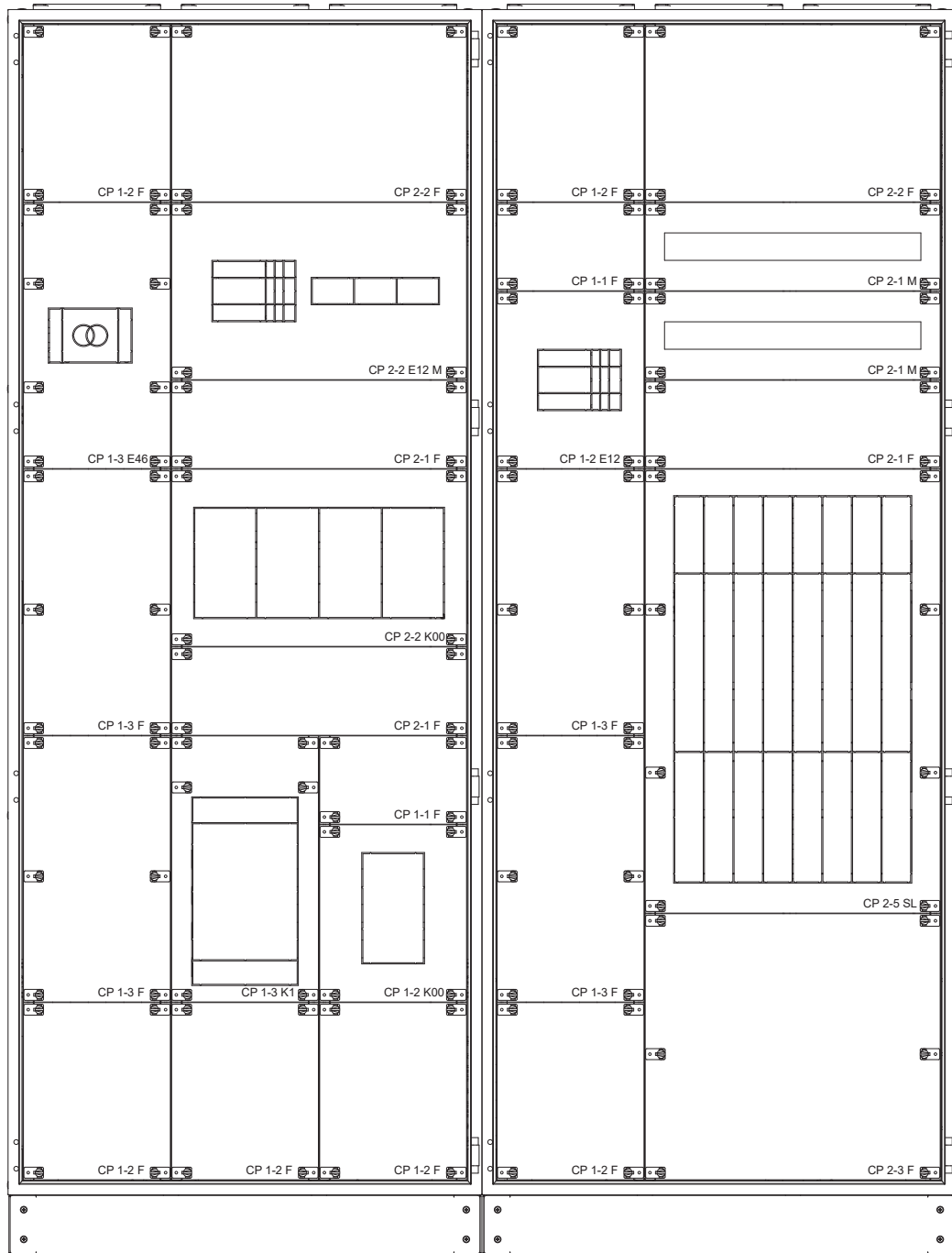

View of the elevation of the enclosure from Example 9

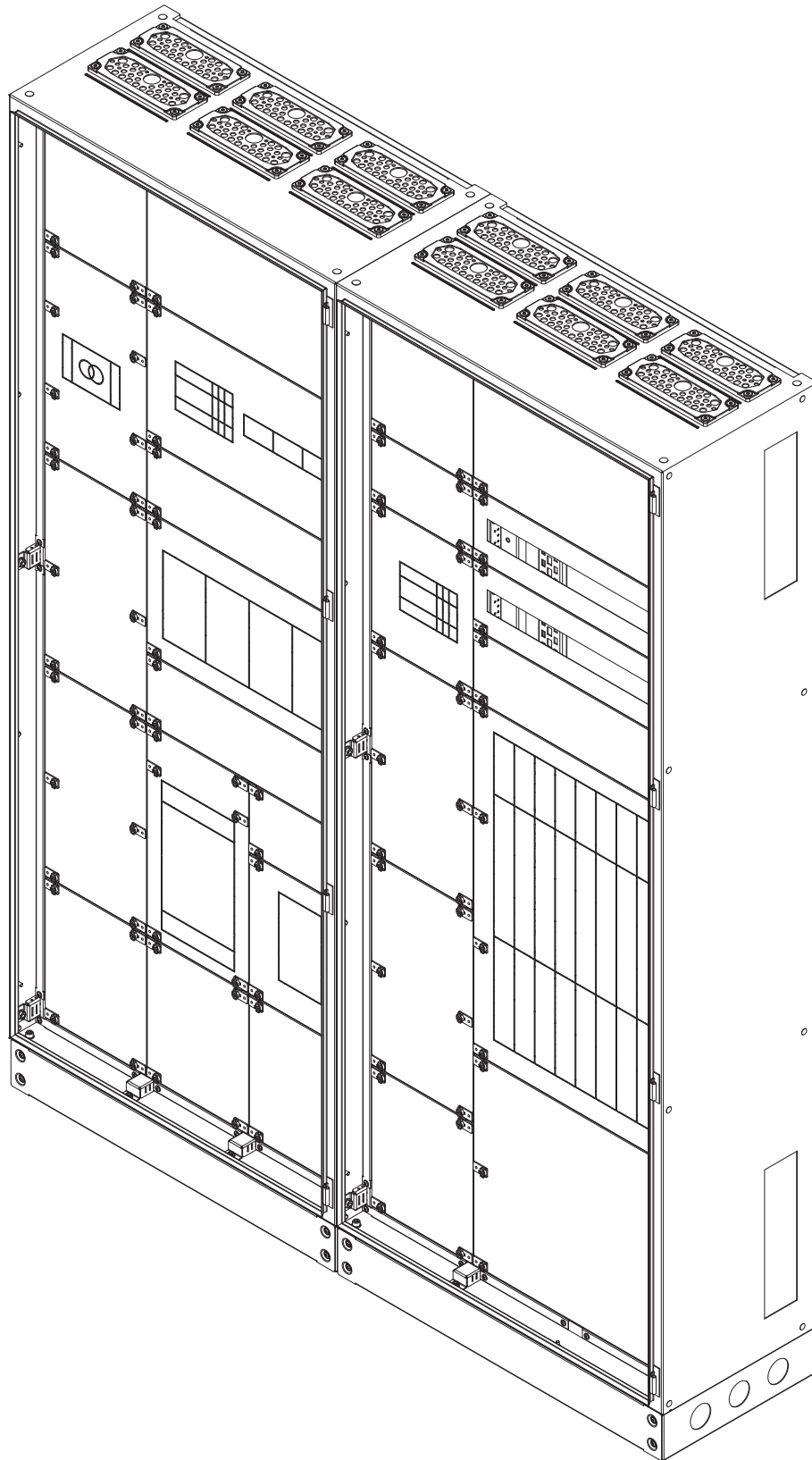

Isometric view of the enclosure from Example 9

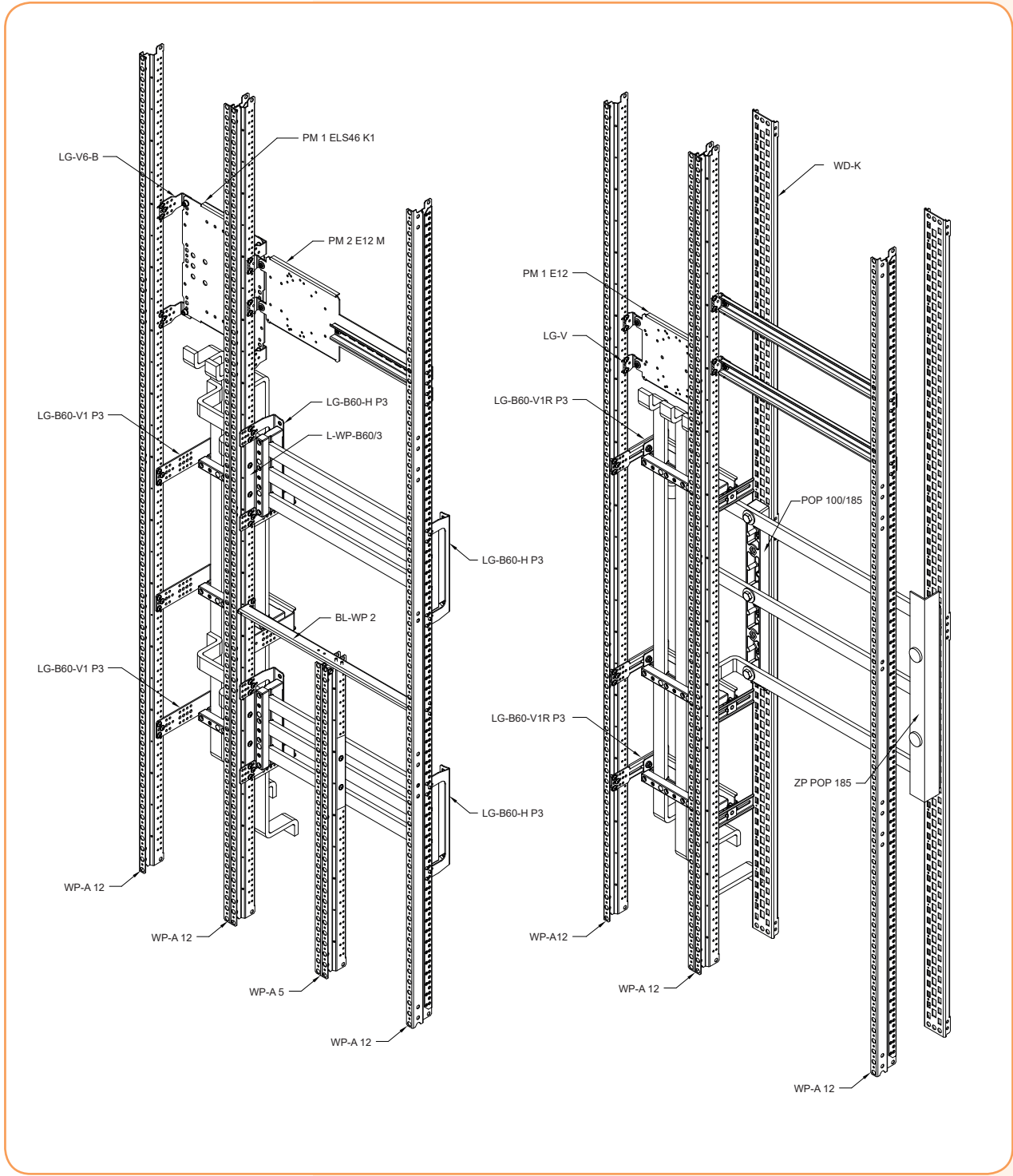

View of the decomposed enclosure from example 9

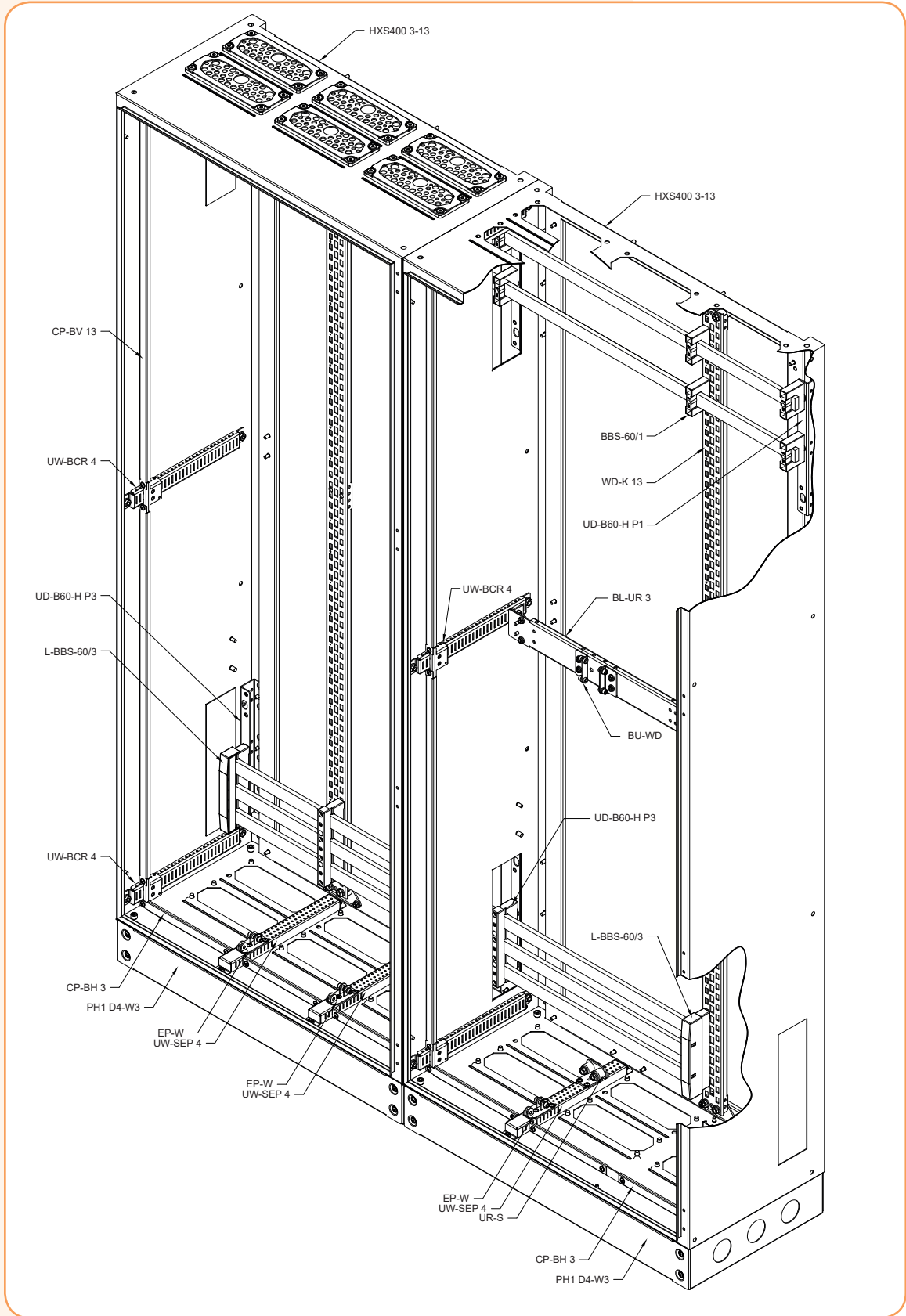

View of the decomposed enclosure from example 9

List of components for the HXS400 3-13 enclosure kit from Example 9

No.	Type	Product name	Code no.	Quantity to order
1	HXS400 3-13	Empty standing enclosure, IP65, class I RAL7035 (800x2000x400) without plinth	001327509	2
2	PH1 D4-W3	100 mm high plinth RAL 9005 for HXS400 enclosures with a width of 3 (800)	001336920	2
3	WP-A 13	Vertical support 2-position type A (1950) (1 set = left and right)	001338606	4
4	WP-A 5	Vertical support 2 position type A (750) (1 set = left and right)	001101647	1
5	WD-K 13	Vertical support type K for cage nuts (1950) (1 piece)	001338865	4
6	UW-BCR 4	Adjustable internal set bracket for HXS enclosures with a depth of 400 mm (1 set = 2 pcs)	001338207	6
7	UW-SEP 4	Dividing bracket for HXS enclosures with a depth of 400 mm	001338303	5
8	BL-WP 2	Dividing bar width 2 (500) split 1: 1	001338900	1
9	EP-W	Dividing element of the enclosure (1 set = 2 pcs.)	001101677	3
10	UA-S	Center bracket for PM-G plates and WD supports mounted on the back of the enclosure (1 set = 2 pcs)	001338104	2
11	BL-UR 3	Stiffening bar with adjustable depth, width 3 (750) (1 set)	001338146	1
12	BU-WD	Bracket for WD supports, fixed to a stiffening bar (1 set = 2 pcs)	001338161	2
13	CR-A	Leading element to UW-BCR without the possibility of screwing covers (1 set = 2 pcs)	001338215	1
14	LG-V SET	Fixing element with M5 nut (1 set = 2 pcs.)	001101683	6
15	LG-V6-B SET	Fixing element with M6 nut type V6-B (1 set = 2 pcs)	001341151	2
16	PM 1 ELS46 K1	Mounting plate 1xEB2 / ED2 / LA 400, 630A 3,4P or 1xLBS 400, 630A 3P or 1xKVL1 (250)	001340700	1
17	PM 1 E12 L12	Mounting plate 1xEB2 / ED2 125,160,250 A 3,4P or 1xLA1,2 (250)	001101584	1
18	PM 2 E12 M	1xEB2 / ED2 mounting plate with TH35 rail for 12 mod. (500)	001101572	1
19	TH-S 2	Steel mounting rail 35/15 1.5 465 mm (500)	002911042	2
20	LG-B60-V1R P3	Bracket with BBS 3-pole carrier, width 1 (250)	001341750	3
21	LG-B60-H P3	Bracket with 3-pole BBS carrier	001341651	4
22	LG-B60-V1 P3	Bracket with BBS 3-pole carrier, width 1 (250)	001341700	3
23	UD-B60-H P1	Bracket with 1-pole BBS carrier	001341800	2
24	UD-B60-H P3	Bracket with 3-pole BBS carrier	001341802	2
25	BBS-60/1	Insulating busbar carrier, 1-pole	001696000	6
26	BBS-60/3	Insulation carrier for busbars with a thickness of 5 or 10 mm, 3-pole	001696001	2
27	L-BBS-60/3	Side insulation cover for 3-pole BBS carrier	001696006	4
28	L-WP-B60/3	3-pole Insulating cover, for mounting on vertical supports, providing insulation from busbars	001342181	3
29	BBC-1/30	Insulating cover for a single busbar, for 30 mm wide rails and thickness of 5 or 10 mm, length 1 m	001696012	1
30	POP 100/185	Insulation carrier for busbars with a spacing of 100 and 185 mm	001691055	2
31	ZP POP 185	Side insulation cover for POP 100/185 carrier, for busbars with 185 mm spacing	001691057	1
32	CP 1-1 F	Full cover (250x150)	001101429	2
33	CP 1-2 F	Full cover (250x300)	001101436	6
34	CP 1-3 F	Full cover (250x450)	001101443	4
35	CP 2-1 F	Full cover (500x150)	001101431	3
36	CP 2-2 F	Full cover (500x300)	001101438	2
37	CP 2-3 F	Full cover (500x450)	001101444	1
38	CP 1-3 E46	Cover 1xEB2 / ED2 400, 630A 3,4P (250x450)	001339300	1
39	CP 1-3 K1	Cover 1xKVL1 (250x450)	001339550	1
40	CP 1-2 K00	Cover 1xKVL00 (250x300)	001339500	1
41	CP 2-2 K00	Cover 4xKVL00 (500x300)	001339502	1
42	CP 2-2 E12 M	Cover 1xEB2 / ED2 125,160,250A 3,4P and 12 mod. (500x300)	001101483	1
43	CP 1-2 E12	Cover 1xEB2 / ED2 125.160.250A 3.4P (250x300)	001101514	1
44	CP 2-1 M	Modular cover 24 mod. (500x150)	001101453	2
45	CP 2-5 SL	Cover 8xSL00 or 4xSL1,2,3 (500x750)	001339752	1
46	CP-BV 13	Side vertical additional covers, side, left and right, for HXS enclosures, height 13 (1950) (1 set)	001340165	2
47	CP-BH 3	Divided horizontal additional covers, upper and lower, for HXS enclosures, width 3 (750) (1 set)	001340201	2
48	ZL-GXA-SEAL	Kit for connecting the enclosures (1 set)	001342651	1
49	AS-SH 6x35 SET	Metric Allen screw - M6 (1 set = 10 pcs.)	001343415	2
50	AS-SH 8x16 SET	Metric Allen screw - M8 (1 set = 10 pcs.)	001343421	1
51	AN-KFH 8x13 M6	M6 cage nut inserted from the front to the 8 x 13 mm hole	001343730	10
52	AN-KFH 10.5x16.5 M8	The M8 cage nut inserted from the front to the 10.5 x 16.5 mm hole	001343731	1

