



# InfraRed Industrial Heat Incandescent

PAR38 IR 100W E27 230V Red 1CT

The Philips infrared incandescent reflector lamps are designed to work in the toughest environment such as farm, bathroom or kitchen and their nearest surrounding. They have a reinforced construction thanks to hard glass use. Their compact form and universal cap base allow them to be used with any suitable equipment. A very good method of generating warmth is by using heat lamps. The Philips infrared lamps provide direct, draught-free warmth to the animals, people, but also food. These benefits have made farmers, consumers and cooks around the world choose Philips infrared lamps, because they are the sturdiest, most efficient lamps available for these applications.

## Product data

### • General Characteristics

Cap-Base	E27
Bulb	PAR38 [PAR 4.75 inch/121mm]
Bulb Material	Hard Glass
Bulb Finish	Red
Operating Position	h45
Main Application	Infrared Industrial
Nominal Lifetime	5000 hr
Rated Lifetime (hours)	5000 hr

### • Light Technical Characteristics

Color Designation (text)	R
--------------------------	---

### • Electrical Characteristics

Lamp Wattage	100 W
Voltage	230 V
Dimmable	Yes

### • Product Dimensions

Overall Length C	136 (max) mm
------------------	--------------

Overall Length Rim C1	124 (max) mm
Diameter D	121 mm

### • Product Data

Order code	923801144209
Full product code	923801144209
Full product name	PAR38 IR 100W E27 230V Red 1CT
Order product name	PAR38 IR 100W E27 230V Red 1CT/12
Pieces per pack	1
Packing configuration	12
Packs per outerbox	12
Bar code on pack - EAN1	8711500600523
Bar code on outerbox - EAN3	8727900207200
Logistic code(s) - 12NC	923801144209
Net weight per piece	308.000 gr

**PHILIPS**

## Dimensional drawing

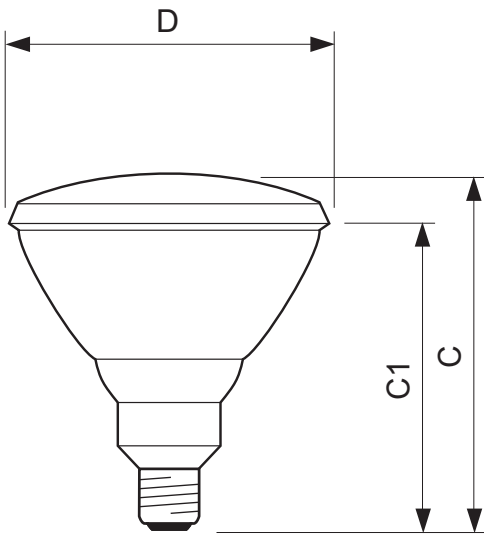

### PAR38 IR 100W E27 230V Red 1CT

Product	C (Min)	C (Norm)	C (Max)	C1 (Min)	C1 (Norm)	C1 (Max)	D (Min)	D (Norm)	D (Max)
PAR38 IR 100W E27 230V Red	-	-	136	-	-	124	-	121	-



E27



© 2015 Koninklijke Philips N.V. (Royal Philips)  
All rights reserved.

Specifications are subject to change without notice. Trademarks are the property of Koninklijke Philips N.V. (Royal Philips) or their respective owners.

[www.philips.com/lighting](http://www.philips.com/lighting)

2015, July 15  
data subject to change