

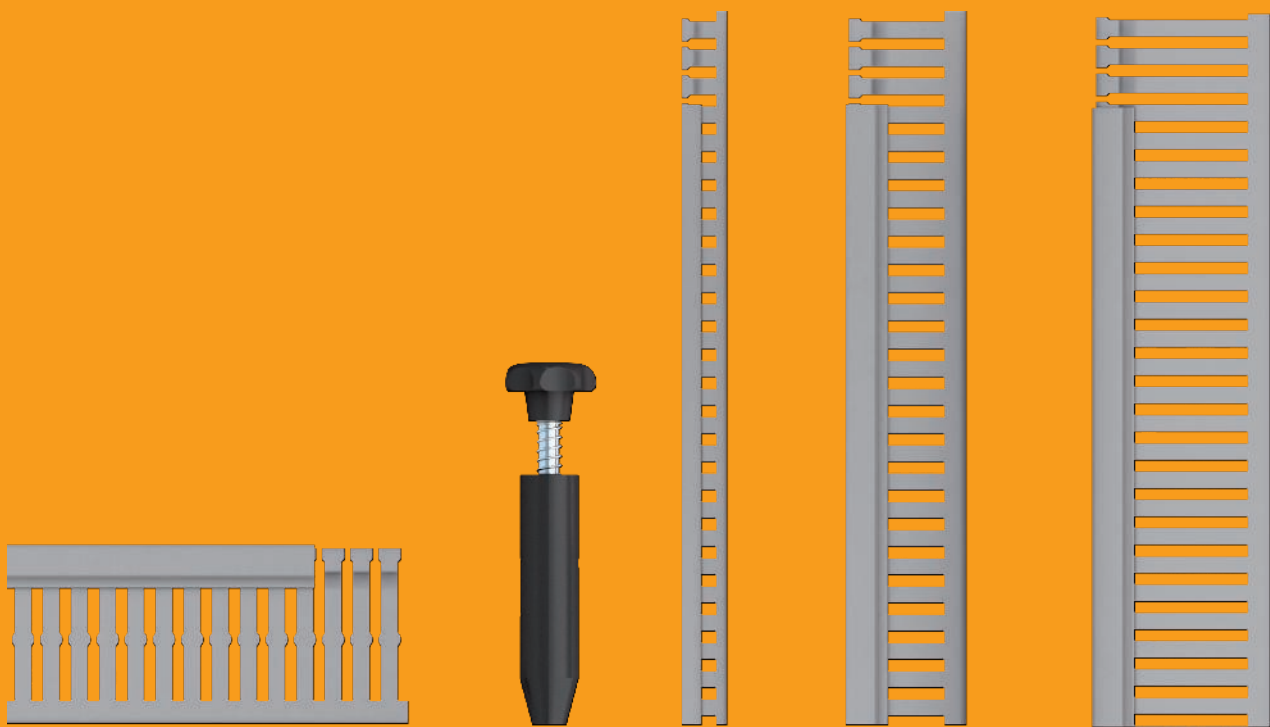

Wiring trunkings



OBO wiring trunking



An exceptionally large range of products in the usual high quality: Wiring trunking ensures tidy wiring in a switchgear cabinet. All the trunking is made from lead-free material. And, for optimum safety, a selection of halogen-free trunking is available from our range.

For professional wiring installation, wiring trunking in dimensions between 15 x 15 mm and 100 x 100 mm is available. A soft, burr-free slot and rounded tabs make mounting easier and also prevent injuries. Upon request we can also offer special designs.



Precise measurements and tested quality

The LK4 and LK4/N as well as the LKV and LKV/N trunking systems have exactly predetermined points for easy breaking-out of the side retainers. All the types have, depending on their size, single or dual track perforation to their base. Tapering in the side slots of the LK4/N and LKV/N types prevents the cables from falling out.

LK4

Nominal dimensions are internal dimensions

LKV

Only external dimensions

Certified

The wiring trunking is VDE-tested and UL-listed (UL File E301798).



LK4 and LK4/N

OBO offers the LK4 wiring trunking in the measurements from 15 x 15 mm to 80 x 120 mm. Precise processing makes simple attaching and detaching of the cover possible but, at the same time, provides a firm fit.

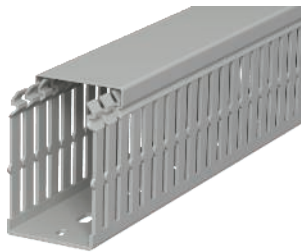

LKV and LKV/N

The special cover contour also guarantees a perfect fit on the LKV wiring trunking. In the dimensions from 25 x 25 mm to 100 x 100 mm (DIN EN 50085- 2-3), it caters for any size requirement.



LKV/H

The LKV/H wiring trunking is halogen-free and available in eight different sizes from 50 x 37.5 mm to 75 x 125 mm.

**HALOGEN
FREE**

- Low smoke creation
- Low toxicity of the smoke gases
- Scarcely any release of corrosive gases

Modular system

Wiring trunking



OBO wiring trunking stands out through a wide range of benefits which have long proven their worth in switchgear cabinet construction. Even in continuous operation, it guarantees secure connections and the reliable function of the electrical infrastructure.

1

Stable trunking with high-quality thicknesses

2

Exact predetermined breaking points in the strut and base area

3

Soft, burr-free slot, rounded tabs

4

Absolute dimensional accuracy of the side perforation and of the base perforation

5

Cut edges rounded and deburred in the closing area

6

Firm positioning of the covers through optimum closing contours

7

Wire retaining lug, allows wiring without wire retaining bracket and prevents routed wires from falling out



Special solutions

- Starting dimension of the base perforation can be adjusted variably
- Available without base perforation
- Special lengths
- Special colours

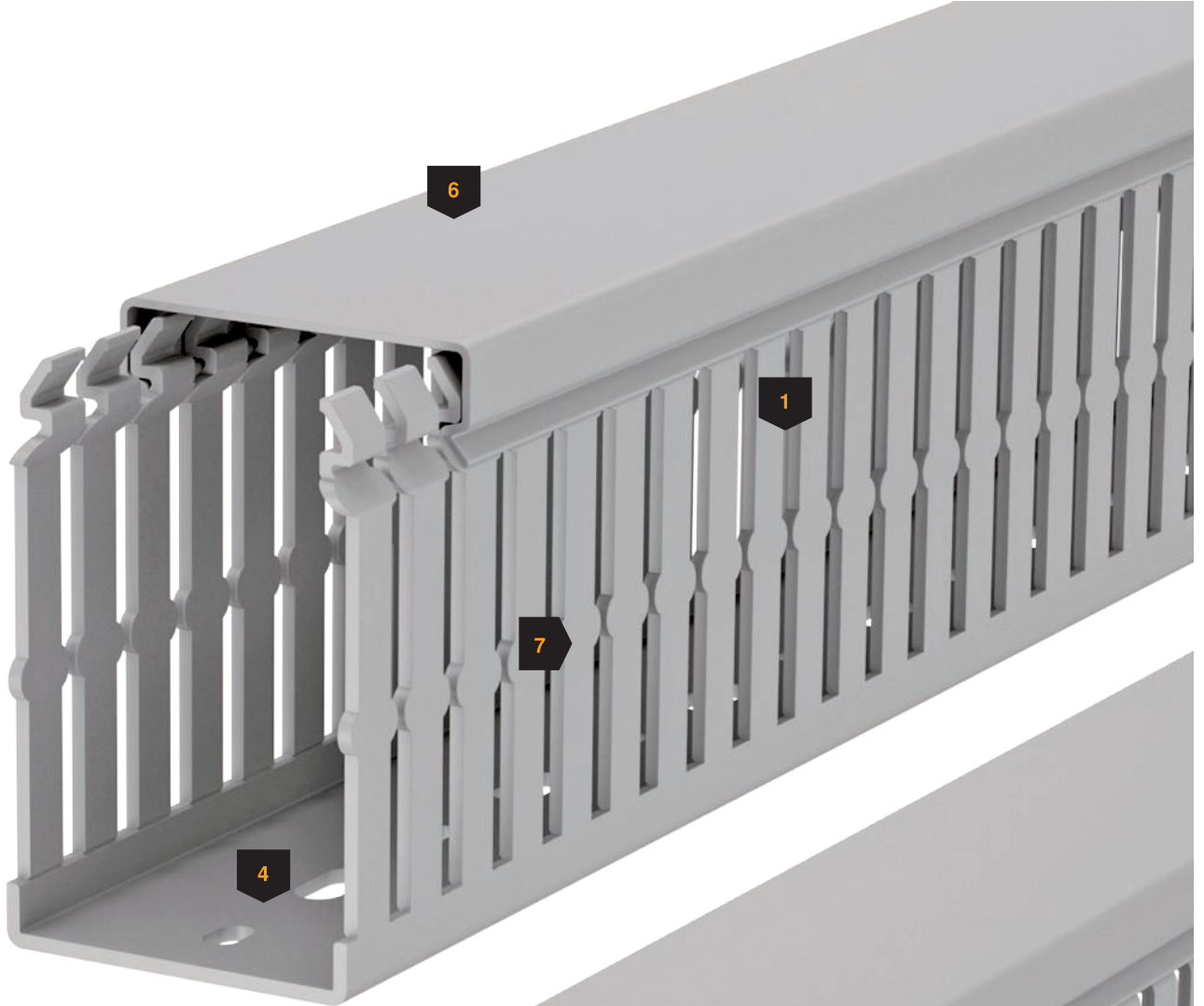

Release pliers

The side retainers can be removed down to the base of the trunking using the release pliers. When the side retainers have been broken out, there is no loss in volume in the transition area to the next trunking piece.



Mounting of the wiring trunking

The wiring trunking is fastened to the mounting plate of the switching cabinet using spreading rivets. The spreading rivets are installed using the plastic rivet tool.

06 LFS Broschüre - Verteilungskanal 2018 - Produktteil_Version EN / en / 2018/10/12 08:17:09 08:17:09 (LLExport_02462) / 2018/10/12



Spacer mounting

Through the mounting on spacers, it is possible to install the wiring trunking at a distance to the mounting plate.





Wire retainer mounting

The wire retainer is inserted into the side slot of the wiring trunking. This simplifies cable installation and keeps the cables in place in the wiring trunking. It also guarantees easy attachment of the cover. If installations are required at a later date, then, when the cover is removed, the cables are held in the trunking and do not fall out.



Wire retainers

The wire retainers can be adjusted according to the trunking width. To do this, simply break off the wire retainer at the predetermined breaking points. This means that just one wire retainer is necessary for any trunking width.

Base perforation

Single and dual-track floor holes to DIN 43659 enable precise work.

Special solution

Starting dimension of the base perforation can be adjusted variably, if requested by the customer.



Identification plate

Sticker as an identification plate to attach onto wiring trunking in switching cabinets with self-protected power circuits.



Hole patterns and dimensions

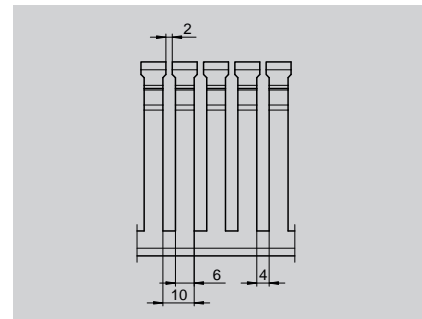
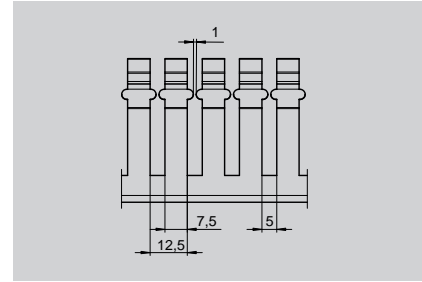
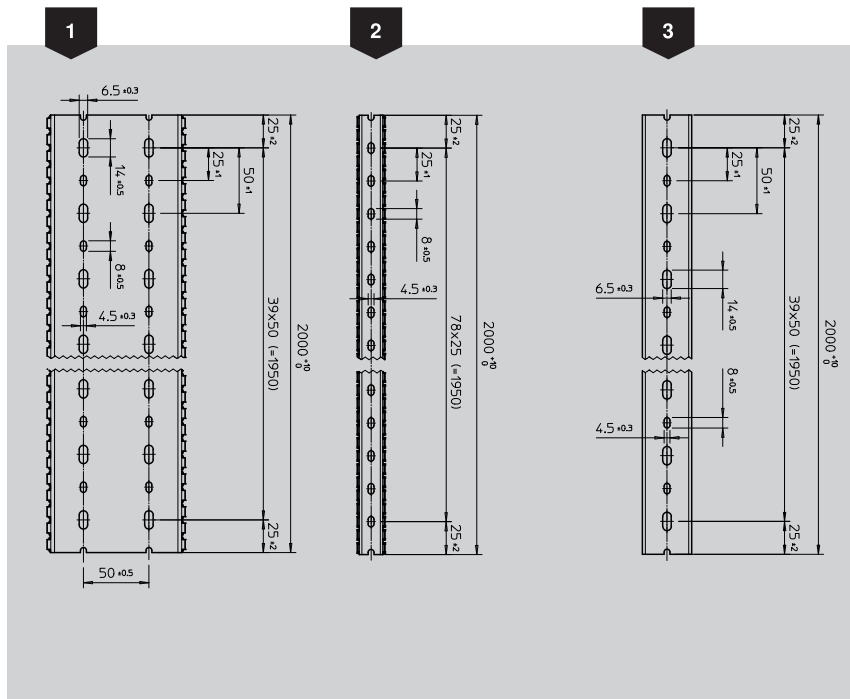

All the VK and VKH wiring trunking always start and finish - with regards to one delivery length (2,000 mm) - with half a small fastening hole (4.5 x 8 mm).

LK4/LK4/N	Item no.	Hole pattern
LK4 15015	6178001	2
LK4 30015	6178003	2
LK4 30025	6178005	3
LK4 40025	6178010	3
LK4 40040	6178012	3
LK4 40060	6178014	3
LK4 40080	6178016	1
LK4 40100	6178018	1
LK4 60015	6178026	2
LK4/N 60015	6178201	2
LK4 60025	6178028	3
LK4/N 60025	6178203	3
LK4 60040	6178031	3
LK4/N 60040	6178205	3
LK4 60060	6178033	3
LK4/N 60060	6178207	3
LK4 60080	6178035	1
LK4/N 60080	6178209	1
LK4 60100	6178037	1
LK4/N 60100	6178211	1
LK4 60120	6178039	1
LK4/N 60120	6178213	1

LK4/LK4/N	Item no.	Hole pattern
LK4 80025	6178050	3
LK4/N 80025	6178225	3
LK4 80040	6178052	3
LK4/N 80040	6178227	3
LK4 80060	6178054	3
LK4/N 80060	6178229	3
LK4 80080	6178056	1
LK4/N 80080	6178231	1
LK4 80100	6178059	1
LK4/N 80100	6178233	1
LK4/N 80120	6178236	1
LK4/N 80120	6178236	1
LK4/N 80120	6178236	1

LKV/H	Item no.	Hole pattern
LKV/H 50037	6178612	2
LKV/H 50050	6178614	2
LKV/H 50075	6178616	2
LKV/H 75037	6178622	2
LKV/H 75050	6178624	2
LKV/H 75075	6178626	1
LKV/H 75100	6178628	1
LKV/H 75125	6178630	1

LKV/LKV/N	Item no.	Hole pattern
LKV 25025	6178302	3
LKV 37025	6178305	3
LKV 37037	6178307	3
LKV 50025	6178310	3
LKV 50037	6178312	3
LKV 50050	6178314	3
LKV 50075	6178316	1

LKV/LKV/N	Item no.	Hole pattern
LKV 75025	6178320	3
LKV/N 75025	6178420	3
LKV 75037	6178322	3
LKV 75037	6178422	3
LKV 75050	6178324	3
LKV/N 75050	6178424	3
LKV 75075	6178326	1
LKV/N 75075	6178426	1
LKV 75100	6178328	1
LKV/N 75100	6178428	1
LKV 75125	6178330	1
LKV/N 75125	6178430	1
LKV 10037	6178334	3
LKV/N 10037	6178435	3
LKV 10050	6178336	3
LKV/N 10050	6178437	3
LKV 10075	6178338	1
LKV/N 10075	6178439	1
LKV 100100	6178341	1

Dimensions, LK4 wiring trunking

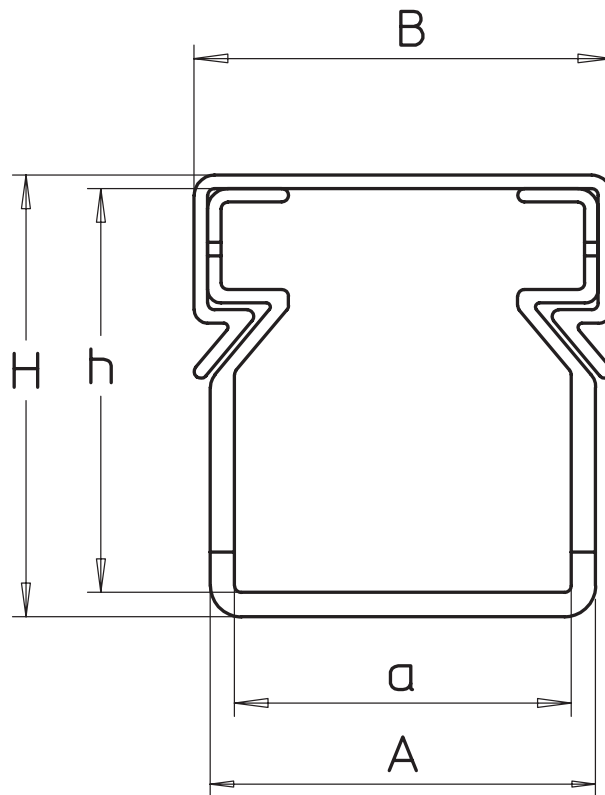





Dimensions LK4

Item no.	Type	Item no.	Type	Dimension a mm	Dimension A mm	Dimension B mm	Dimension h mm	Dimension H mm
6178001	LK4 15015			15	17	20	15	17
6178003	LK4 30015			15	17.8	20	30	32.4
6178005	LK4 30025			25	28.6	31	30	32.8
6178010	LK4 40025			25	28.6	31	40	42.8
6178012	LK4 40040			40	43.6	46.2	40	43
6178014	LK4 40060			60	64	66.4	40	43.2
6178016	LK4 40080			80	84	87	40	43.5
6178018	LK4 40100			100	104	107.4	40	43.7
6178026	LK4 60015	6178201	LK4 N 60015	15	18.6	20	60	62.8
6178028	LK4 60025	6178203	LK4 N 60025	25	29	31	60	63
6178031	LK4 60040	6178205	LK4 N 60040	40	44	46.2	60	63
6178033	LK4 60060	6178207	LK4 N 60060	60	64	66.4	60	63.2
6178035	LK4 60080	6178209	LK4 N 60080	80	84.4	87	60	63.7
6178037	LK4 60100	6178211	LK4 N 60100	100	104.6	107.4	60	64
6178039	LK4 60120	6178213	LK4 N 60120	120	124.6	127.8	60	64.2
6178050	LK4 80025	6178225	LK4 N 80025	25	29.4	31	80	83.2
6178052	LK4 80040	6178227	LK4 N 80040	40	44.4	46.2	80	83.3
6178054	LK4 80060	6178229	LK4 N 80060	60	64.4	66.4	80	83.4
6178056	LK4 80080	6178231	LK4 N 80080	80	84.6	87	80	83.9
6178059	LK4 80100	6178233	LK4 N 80100	100	104.8	107.4	80	84.1
6178061	LK4 80120	6178236	LK4 N 80120	120	124.8	127.8	80	84.3



VK wiring duct system

	LK4 wiring trunking	14
	LK4/N wiring trunking with wire retaining lug	20
	LKV DIN wiring trunking	24
	LKV/N DIN wiring trunking with wire retaining lug	29
	Accessories	32

Wiring trunking, type LK4 15015

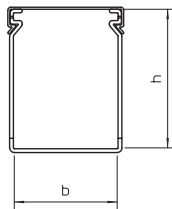

Type	Colour	Dimension		Pack. m	Weight kg/100 m	Item No.
		Length mm	W x H mm			
LK4 15015	Stone grey	2000	15x15	72	12.000	6178001

PVC Polyvinylchloride

Wiring trunking, type LK4 30015

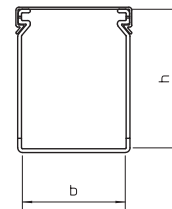

Type	Colour	Dimension		Pack. m	Weight kg/100 m	Item No.
		Length mm	W x H mm			
LK4 30015	Stone grey	2000	15x30	40	18.000	6178003

PVC Polyvinylchloride

Cover

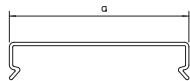

Type	Colour	Dimension a mm	Length mm	Pack. m	Weight kg/100 m	Item No.

PVC Polyvinylchloride

Wiring trunking, type LK4 30025

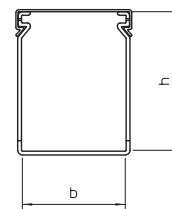

Type	Colour	Dimension		Pack. m	Weight kg/100 m	Item No.
		Length mm	W x H mm			
LK4 30025	Stone grey	2000	25x30	48	28.000	6178005

PVC Polyvinylchloride

Cover

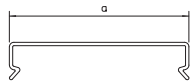

Type	Colour	Dimension a mm	Length mm	Pack. m	Weight kg/100 m	Item No.

PVC Polyvinylchloride

Wiring trunking, type LK4 40025

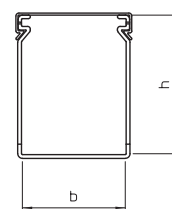

Type	Colour	Dimension		Pack. m	Weight kg/100 m	Item No.
		Length mm	W x H mm			
LK4 40025	Stone grey	2000	25x40	48	36.500	6178010

PVC Polyvinylchloride

Cover

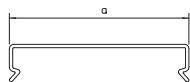

Type	Colour	Dimension a mm	Length mm	Pack. m	Weight kg/100 m	Item No.

PVC Polyvinylchloride

Wiring trunking, type LK4 40040

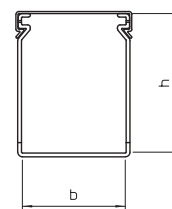

Type	Colour	Dimension		Pack. m	Weight kg/100 m	Item No.
		Length mm	W x H mm			
LK4 40040	Stone grey	2000	40x40	36	44.000	6178012

PVC Polyvinylchloride

Cover

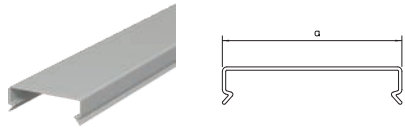

Type	Colour	Dimension a mm	Length mm	Pack. m	Weight kg/100 m	Item No.
LK4 D 40	Stone grey	46.2	2000	24	13.500	6178484

PVC Polyvinylchloride

Cover

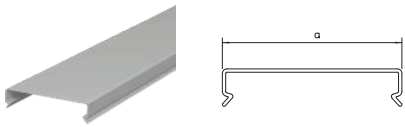

Type	Colour	Dimension a mm	Length mm	Pack. m	Weight kg/100 m	Item No.
LK4 D 60	Stone grey	66.4	2000	40	18.000	6178486

PVC Polyvinylchloride

Cover

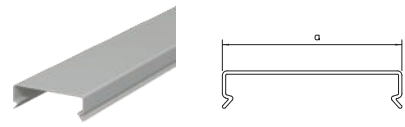

Type	Colour	Dimension a mm	Length mm	Pack. m	Weight kg/100 m	Item No.
LK4 D 80	Stone grey	87	2000	12	27.000	6178488

PVC Polyvinylchloride

Cover

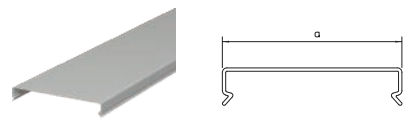

Type	Colour	Dimension a mm	Length mm	Pack. m	Weight kg/100 m	Item No.
LK4 D 100	Stone grey	107.4	2000	12	35.500	6178490

PVC Polyvinylchloride

Wiring trunking, type LK4 40060

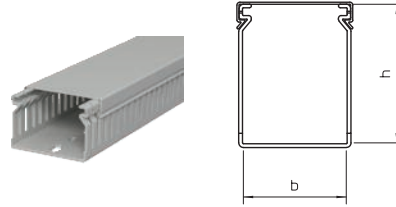

Type	Colour	Length mm	Dimension W x H mm	Pack. m	Weight kg/100 m	Item No.
LK4 40060	Stone grey	2000	60x40	24	57.000	6178014

PVC Polyvinylchloride

Wiring trunking, type LK4 40080

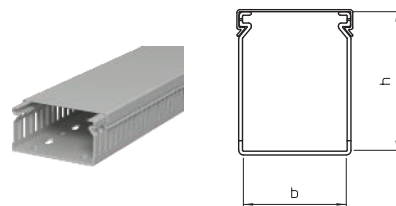

Type	Colour	Length mm	Dimension W x H mm	Pack. m	Weight kg/100 m	Item No.
LK4 40080	Stone grey	2000	80x40	24	71.000	6178016

PVC Polyvinylchloride

Wiring trunking, type LK4 40100

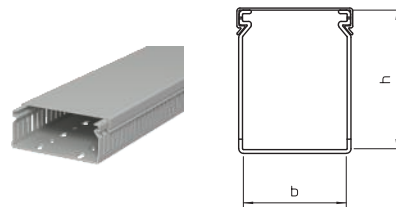

Type	Colour	Length mm	Dimension W x H mm	Pack. m	Weight kg/100 m	Item No.
LK4 40100	Stone grey	2000	100x40	24	85.500	6178018

PVC Polyvinylchloride

Wiring trunking, type LK4 60015

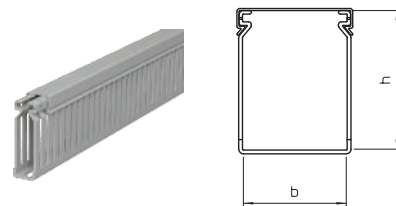

Type	Colour	Length mm	Dimension W x H mm	Pack. m	Weight kg/100 m	Item No.
LK4 60015	Stone grey	2000	15x60	48	32.500	6178026

PVC Polyvinylchloride

Cover

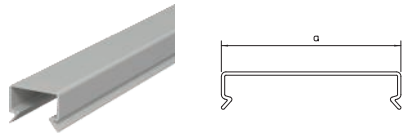

Type	Colour	Dimension a mm	Length mm	Pack. m	Weight kg/100 m	Item No.
LK4 D 15	Stone grey	20	2000	92	8.500	6178480

PVC Polyvinylchloride

Cover

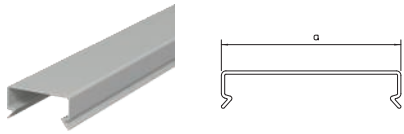

Type	Colour	Dimension a mm	Length mm	Pack. m	Weight kg/100 m	Item No.
LK4 D 25	Stone grey	31	2000	32	10.000	6178482

PVC Polyvinylchloride

Cover

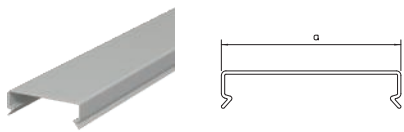

Type	Colour	Dimension a mm	Length mm	Pack. m	Weight kg/100 m	Item No.
LK4 D 40	Stone grey	46.2	2000	24	13.500	6178484

PVC Polyvinylchloride

Cover

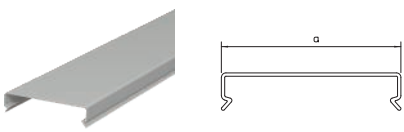

Type	Colour	Dimension a mm	Length mm	Pack. m	Weight kg/100 m	Item No.
LK4 D 60	Stone grey	66.4	2000	40	18.000	6178486

PVC Polyvinylchloride

Wiring trunking, type LK4 60025

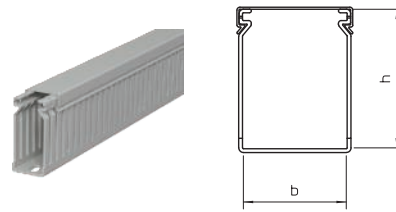

Type	Colour	Length mm	Dimension W x H mm	Pack. m	Weight kg/100 m	Item No.
LK4 60025	Stone grey	2000	25x60	32	46.000	6178028

PVC Polyvinylchloride

Wiring trunking, type LK4 60040

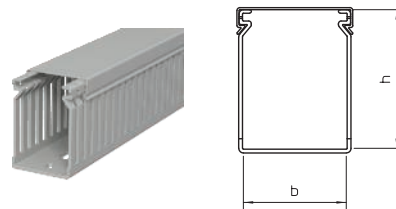

Type	Colour	Length mm	Dimension W x H mm	Pack. m	Weight kg/100 m	Item No.
LK4 60040	Stone grey	2000	40x60	24	53.500	6178031

PVC Polyvinylchloride

Wiring trunking, type LK4 60060

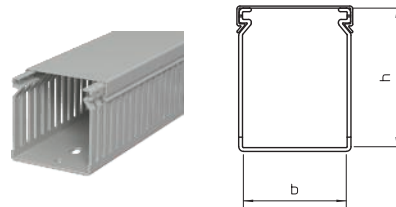

Type	Colour	Length mm	Dimension W x H mm	Pack. m	Weight kg/100 m	Item No.
LK4 60060	Stone grey	2000	60x60	32	64.500	6178033

PVC Polyvinylchloride

Wiring trunking, type LK4 60080

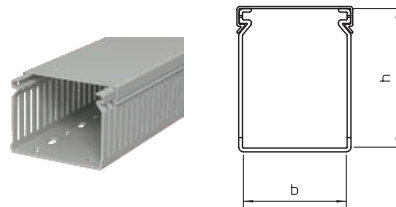

Type	Colour	Length mm	Dimension W x H mm	Pack. m	Weight kg/100 m	Item No.
LK4 60080	Stone grey	2000	80x60	24	82.500	6178035

PVC Polyvinylchloride

Cover

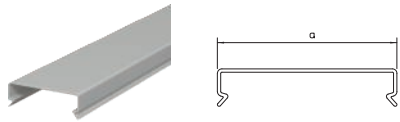

Type	Colour	Dimension a mm	Length mm	Pack. m	Weight kg/100 m	Item No.
LK4 D 80	Stone grey	87	2000	12	27.000	6178488

PVC Polyvinylchloride

Cover

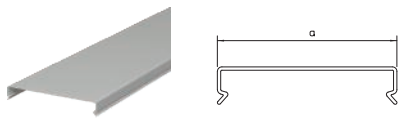

Type	Colour	Dimension a mm	Length mm	Pack. m	Weight kg/100 m	Item No.
LK4 D 100	Stone grey	107.4	2000	12	35.500	6178490

PVC Polyvinylchloride

Cover

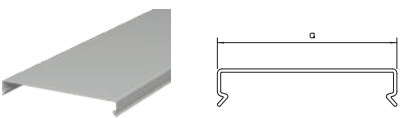

Type	Colour	Dimension a mm	Length mm	Pack. m	Weight kg/100 m	Item No.
LK4 D 120	Stone grey	127.8	2000	16	45.500	6178492

PVC Polyvinylchloride

Cover

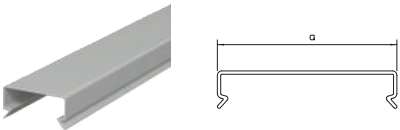

Type	Colour	Dimension a mm	Length mm	Pack. m	Weight kg/100 m	Item No.
LK4 D 25	Stone grey	31	2000	32	10.000	6178482

PVC Polyvinylchloride

Wiring trunking, type LK4 60100

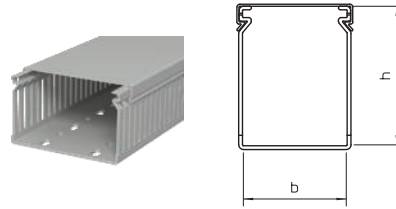

Type	Colour	Length mm	Dimension W x H mm	Pack. m	Weight kg/100 m	Item No.
LK4 60100	Stone grey	2000	100x60	16	100.000	6178037

PVC Polyvinylchloride

Wiring trunking, type LK4 60120

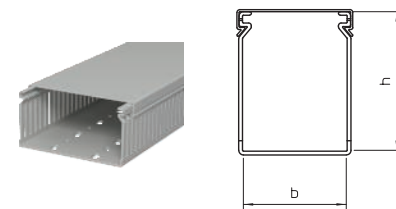

Type	Colour	Length mm	Dimension W x H mm	Pack. m	Weight kg/100 m	Item No.
LK4 60120	Stone grey	2000	120x60	8	117.000	6178039

PVC Polyvinylchloride

Wiring trunking, type LK4 80025

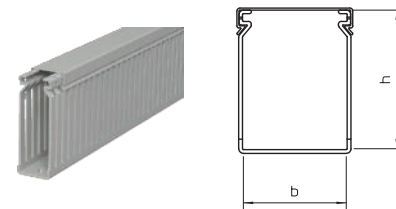

Type	Colour	Length mm	Dimension W x H mm	Pack. m	Weight kg/100 m	Item No.
LK4 80025	Stone grey	2000	25x80	32	61.000	6178050

PVC Polyvinylchloride

Wiring trunking, type LK4 80040

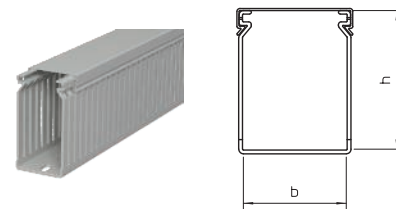

Type	Colour	Length mm	Dimension W x H mm	Pack. m	Weight kg/100 m	Item No.
LK4 80040	Stone grey	2000	40x80	24	64.500	6178052

PVC Polyvinylchloride

Cover

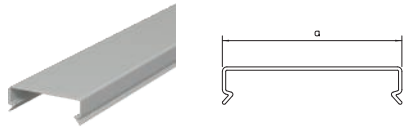

Type	Colour	Dimension a mm	Length mm	Pack. m	Weight kg/100 m	Item No.
LK4 D 40	Stone grey	46.2	2000	24	13.500	6178484

PVC Polyvinylchloride

Cover

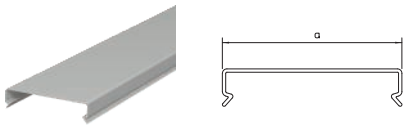

Type	Colour	Dimension a mm	Length mm	Pack. m	Weight kg/100 m	Item No.
LK4 D 60	Stone grey	66.4	2000	40	18.000	6178486

PVC Polyvinylchloride

Cover

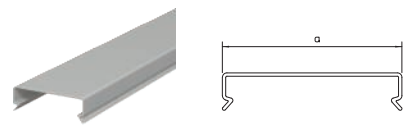

Type	Colour	Dimension a mm	Length mm	Pack. m	Weight kg/100 m	Item No.
LK4 D 80	Stone grey	87	2000	12	27.000	6178488

PVC Polyvinylchloride

Cover

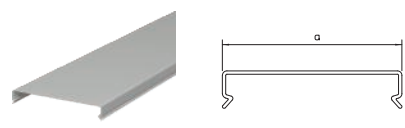

Type	Colour	Dimension a mm	Length mm	Pack. m	Weight kg/100 m	Item No.
LK4 D 100	Stone grey	107.4	2000	12	35.500	6178490

PVC Polyvinylchloride

Wiring trunking, type LK4 80060

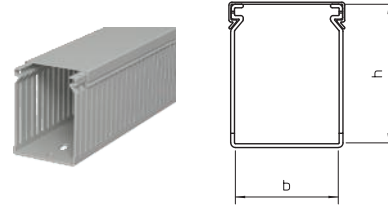

Type	Colour	Length mm	Dimension W x H mm	Pack. m	Weight kg/100 m	Item No.
LK4 80060	Stone grey	2000	60x80	24	76.000	6178054

PVC Polyvinylchloride

Wiring trunking, type LK4 80080

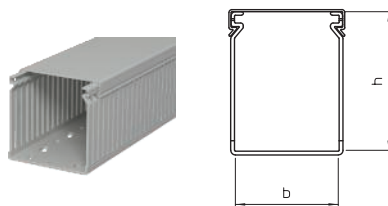

Type	Colour	Length mm	Dimension W x H mm	Pack. m	Weight kg/100 m	Item No.
LK4 80080	Stone grey	2000	80x80	16	95.500	6178056

PVC Polyvinylchloride

Wiring trunking, type LK4 80100

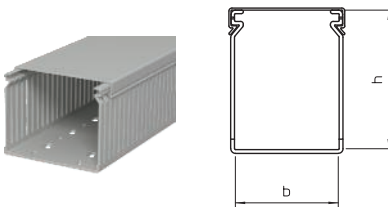

Type	Colour	Length mm	Dimension W x H mm	Pack. m	Weight kg/100 m	Item No.
LK4 80100	Stone grey	2000	100x80	16	111.500	6178059

PVC Polyvinylchloride

Wiring trunking, type LK4 80120

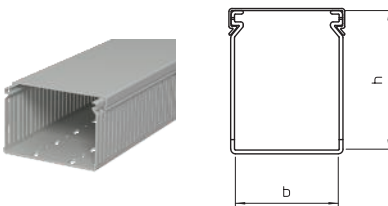

Type	Colour	Length mm	Dimension W x H mm	Pack. m	Weight kg/100 m	Item No.
LK4 80120	Stone grey	2000	120x80	8	128.500	6178061

PVC Polyvinylchloride

Cover

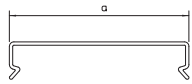
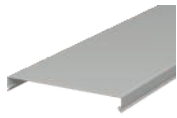

Type	Colour	Dimension a mm	Length mm	Pack. m	Weight kg/100 m	Item No.
LK4 D 120	Stone grey	127.8	2000	16	45.500	6178492
PVC Polyvinylchloride						

Wiring trunking, type LK4/N 60015

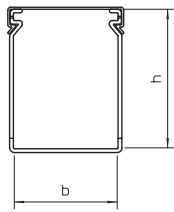

Type	Colour	Length mm	Dimension W x H mm	Pack. m	Weight kg/100 m	Item No.
LK4 N 60015	Stone grey	2000	15x60	48	41.000	6178201

PVC Polyvinylchloride

Cover

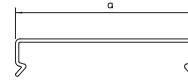

Type	Colour	Dimension a mm	Length mm	Pack. m	Weight kg/100 m	Item No.
LK4 D 15	Stone grey	20	2000	92	8.500	6178480

PVC Polyvinylchloride

Cover

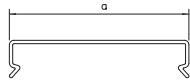

Type	Colour	Dimension a mm	Length mm	Pack. m	Weight kg/100 m	Item No.
LK4 D 25	Stone grey	31	2000	32	10.000	6178482

PVC Polyvinylchloride

Wiring trunking, type LK4/N 60025

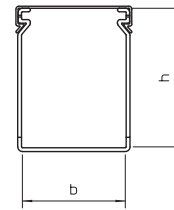

Type	Colour	Length mm	Dimension W x H mm	Pack. m	Weight kg/100 m	Item No.
LK4 N 60025	Stone grey	2000	25x60	32	48.500	6178203

PVC Polyvinylchloride

Wiring trunking, type LK4/N 60040

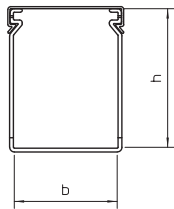

Type	Colour	Length mm	Dimension W x H mm	Pack. m	Weight kg/100 m	Item No.
LK4 N 60040	Stone grey	2000	40x60	24	56.000	6178205

PVC Polyvinylchloride

Cover

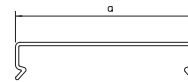
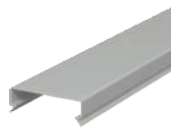

Type	Colour	Dimension a mm	Length mm	Pack. m	Weight kg/100 m	Item No.
LK4 D 40	Stone grey	46.2	2000	24	13.500	6178484

PVC Polyvinylchloride

Cover

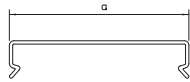
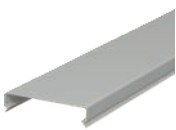

Type	Colour	Dimension a mm	Length mm	Pack. m	Weight kg/100 m	Item No.
LK4 D 60	Stone grey	66.4	2000	40	18.000	6178486

PVC Polyvinylchloride

Wiring trunking, type LK4/N 60060

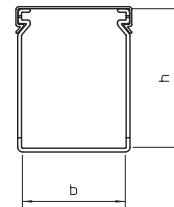

Type	Colour	Length mm	Dimension W x H mm	Pack. m	Weight kg/100 m	Item No.
LK4 N 60060	Stone grey	2000	60x60	32	68.000	6178207

PVC Polyvinylchloride

Wiring trunking, type LK4/N 60080

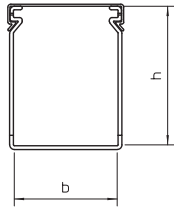

Type	Colour	Length mm	Dimension W x H mm	Pack. m	Weight kg/100 m	Item No.
LK4 N 60080	Stone grey	2000	80x60	24	87.000	6178209

PVC Polyvinylchloride

Cover

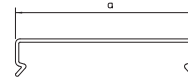
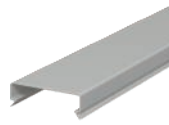

Type	Colour	Dimension a mm	Length mm	Pack. m	Weight kg/100 m	Item No.
LK4 D 80	Stone grey	87	2000	12	27.000	6178488

PVC Polyvinylchloride

Cover

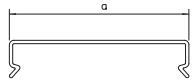
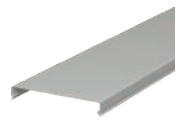

Type	Colour	Dimension a mm	Length mm	Pack. m	Weight kg/100 m	Item No.
LK4 D 100	Stone grey	107.4	2000	12	35.500	6178490

PVC Polyvinylchloride

Wiring trunking, type LK4/N 60100

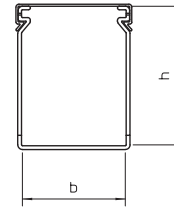
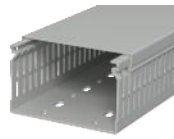

Type	Colour	Length mm	Dimension W x H mm	Pack. m	Weight kg/100 m	Item No.
LK4 N 60100	Stone grey	2000	100x60	16	105.500	6178211

PVC Polyvinylchloride

Wiring trunking, type LK4/N 60120

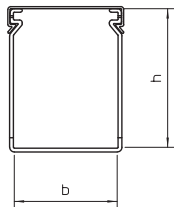

Type	Colour	Length mm	Dimension W x H mm	Pack. m	Weight kg/100 m	Item No.
LK4 N 60120	Stone grey	2000	120x60	8	120.500	6178213

PVC Polyvinylchloride

Cover

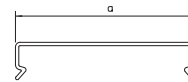
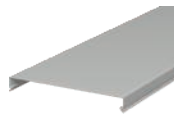

Type	Colour	Dimension a mm	Length mm	Pack. m	Weight kg/100 m	Item No.
LK4 D 120	Stone grey	127.8	2000	16	45.500	6178492

PVC Polyvinylchloride

Cover

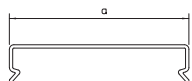

Type	Colour	Dimension a mm	Length mm	Pack. m	Weight kg/100 m	Item No.
LK4 D 25	Stone grey	31	2000	32	10.000	6178482

PVC Polyvinylchloride

Wiring trunking, type LK4/N 80025

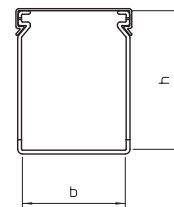

Type	Colour	Length mm	Dimension W x H mm	Pack. m	Weight kg/100 m	Item No.
LK4 N 80025	Stone grey	2000	25x80	32	65.000	6178225

PVC Polyvinylchloride

Wiring trunking, type LK4/N 80040

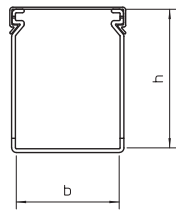

Type	Colour	Length mm	W x H mm	Pack. m	Weight kg/100 m	Item No.
LK4 N 80040	Stone grey	2000	40x80	24	73.500	6178227

PVC Polyvinylchloride

Cover

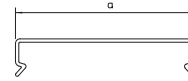

Type	Colour	Dimension a mm	Length mm	Pack. m	Weight kg/100 m	Item No.
LK4 D 40	Stone grey	46.2	2000	24	13.500	6178484

PVC Polyvinylchloride

Cover

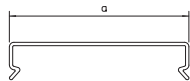
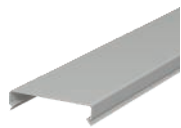

Type	Colour	Dimension a mm	Length mm	Pack. m	Weight kg/100 m	Item No.
LK4 D 60	Stone grey	66.4	2000	40	18.000	6178486

PVC Polyvinylchloride

Wiring trunking, type LK4/N 80060

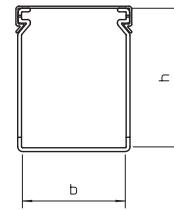

Type	Colour	Length mm	W x H mm	Pack. m	Weight kg/100 m	Item No.
LK4 N 80060	Stone grey	2000	60x80	24	82.000	6178229

PVC Polyvinylchloride

Wiring trunking, type LK4/N 80080

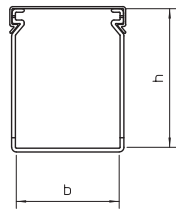

Type	Colour	Length mm	W x H mm	Pack. m	Weight kg/100 m	Item No.
LK4 N 80080	Stone grey	2000	80x80	16	101.000	6178231

PVC Polyvinylchloride

Cover

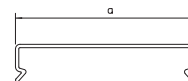

Type	Colour	Dimension a mm	Length mm	Pack. m	Weight kg/100 m	Item No.
LK4 D 80	Stone grey	87	2000	12	27.000	6178488

PVC Polyvinylchloride

Cover

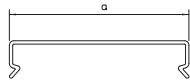
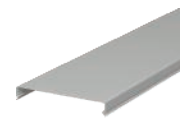

Type	Colour	Dimension a mm	Length mm	Pack. m	Weight kg/100 m	Item No.
LK4 D 100	Stone grey	107.4	2000	12	35.500	6178490

PVC Polyvinylchloride

Wiring trunking, type LK4/N 80100

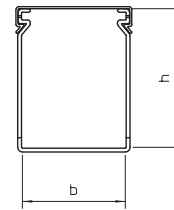

Type	Colour	Length mm	W x H mm	Pack. m	Weight kg/100 m	Item No.
LK4 N 80100	Stone grey	2000	100x80	16	116.500	6178233

PVC Polyvinylchloride

Wiring trunking, type LK4/N 80120

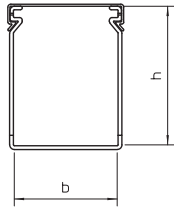
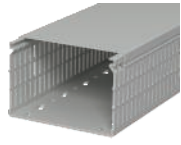

Dimension

Type	Colour	Length mm	W x H mm	Pack. m	Weight kg/100 m	Item No.
LK4 N 80120	Stone grey	2000	120x80	8	133.500	6178236

PVC Polyvinylchloride

Cover

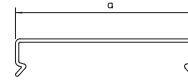

Type	Colour	Dimension a mm	Length mm	Pack. m	Weight kg/100 m	Item No.
LK4 D 120	Stone grey	127.8	2000	16	45.500	6178492

PVC Polyvinylchloride

Wiring trunking, type LKV 25025

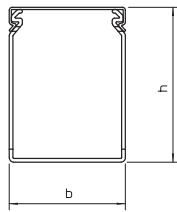

Type	Colour	Dimension		Pack. m	Weight kg/100 m	Item No.
		Length mm	W x H mm			
LKV 25025	Stone grey	2000	25x25	32	24.000	6178302

PVC Polyvinylchloride

Cover

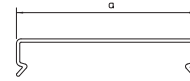
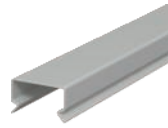

Type	Colour	Dimension a mm	Length mm	Pack. m	Weight kg/100 m	Item No.

PVC Polyvinylchloride

Cover

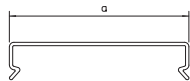
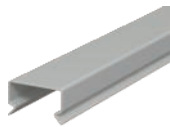

Type	Colour	Dimension a mm	Length mm	Pack. m	Weight kg/100 m	Item No.

PVC Polyvinylchloride

Wiring trunking, type LKV 37025

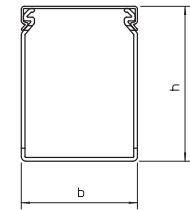

Type	Colour	Dimension a mm	Length mm	W x H mm	Pack. m	Weight kg/100 m	Item No.

PVC Polyvinylchloride

Wiring trunking, type LKV 37037

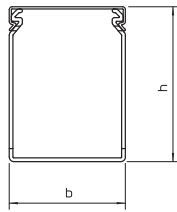

Type	Colour	Length mm	Dimension W x H mm	Pack. m	Weight kg/100 m	Item No.

PVC Polyvinylchloride

Cover

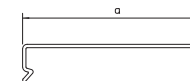

Type	Colour	Dimension a mm	Length mm	Pack. m	Weight kg/100 m	Item No.

PVC Polyvinylchloride

Cover

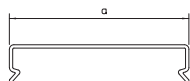

Type	Colour	Dimension a mm	Length mm	Pack. m	Weight kg/100 m	Item No.

PVC Polyvinylchloride

Wiring trunking, type LKV 50025

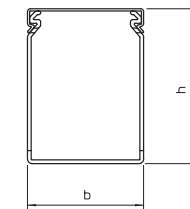

Type	Colour	Length mm	W x H mm	Pack. m	Weight kg/100 m	Item No.

PVC Polyvinylchloride

Wiring trunking, type LKV 50037

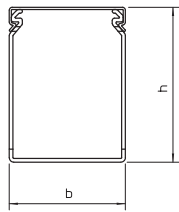

Type	Colour	Dimension		Pack. m	Weight kg/100 m	Item No.
		Length mm	W x H mm			
LKV 50037	Stone grey	2000	37,5 x 50	48	44.500	6178312

PVC Polyvinylchloride

Cover

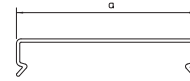

Type	Colour	Dimension a mm	Length mm	Pack. m	Weight kg/100 m	Item No.

PVC Polyvinylchloride

Cover

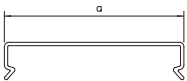

Type	Colour	Dimension a mm	Length mm	Pack. m	Weight kg/100 m	Item No.

PVC Polyvinylchloride

Wiring trunking, type LKV 50050

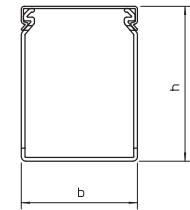

Type	Colour	Length mm	Dimension W x H mm	Pack. m	Weight kg/100 m	Item No.

PVC Polyvinylchloride

Wiring trunking, type LKV 50075

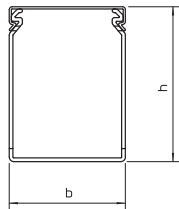

Type	Colour	Length mm	Dimension W x H mm	Pack. m	Weight kg/100 m	Item No.

PVC Polyvinylchloride

Cover

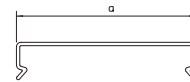

Type	Colour	Dimension a mm	Length mm	Pack. m	Weight kg/100 m	Item No.

PVC Polyvinylchloride

Cover

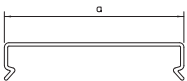

Type	Colour	Dimension a mm	Length mm	Pack. m	Weight kg/100 m	Item No.

PVC Polyvinylchloride

Wiring trunking, type LKV 75025

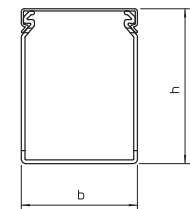

Type	Colour	Length mm	Dimension W x H mm	Pack. m	Weight kg/100 m	Item No.

PVC Polyvinylchloride

Wiring trunking, type LKV 75037

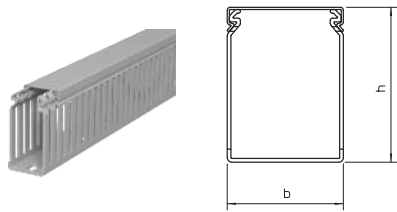

Type	Colour	Dimension		Pack. m	Weight kg/100 m	Item No.
		Length mm	W x H mm			
LKV 75037	Stone grey	2000	37,5 x 75	32	58.500	6178322

PVC Polyvinylchloride

Cover

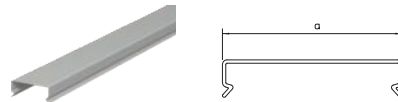

Type	Colour	Dimension a mm	Length mm	Pack. m	Weight kg/100 m	Item No.

PVC Polyvinylchloride

Cover

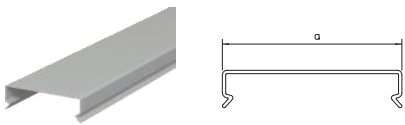

Type	Colour	Dimension a mm	Length mm	Pack. m	Weight kg/100 m	Item No.

PVC Polyvinylchloride

Wiring trunking, type LKV 75050

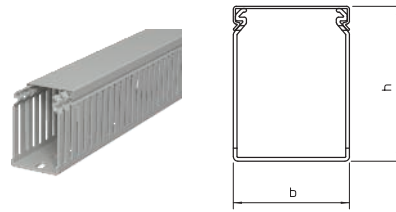

Type	Colour	Length mm	Dimension W x H mm	Pack. m	Weight kg/100 m	Item No.

PVC Polyvinylchloride

Wiring trunking, type LKV 75075

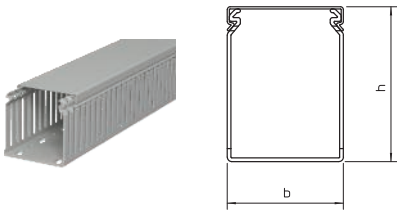

Type	Colour	Length mm	Dimension W x H mm	Pack. m	Weight kg/100 m	Item No.

PVC Polyvinylchloride

Cover

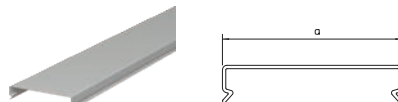

Type	Colour	Dimension a mm	Length mm	Pack. m	Weight kg/100 m	Item No.

PVC Polyvinylchloride

Cover

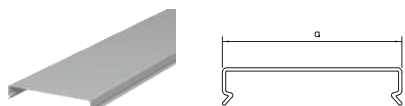

Type	Colour	Dimension a mm	Length mm	Pack. m	Weight kg/100 m	Item No.

PVC Polyvinylchloride

Wiring trunking, type LKV 75100

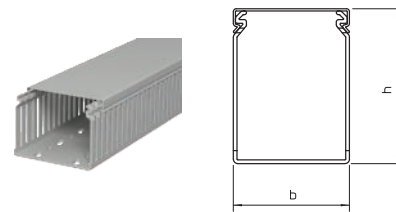

Type	Colour	Length mm	Dimension W x H mm	Pack. m	Weight kg/100 m	Item No.

PVC Polyvinylchloride

Wiring trunking, type LKV 75125

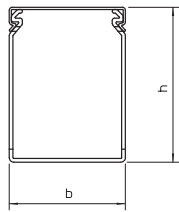
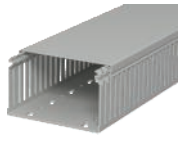

Type	Colour	Dimension		Pack. m	Weight kg/100 m	Item No.
		Length mm	W x H mm			
LKV 75125	Stone grey	2000	125 x 75	8	128.500	6178330

PVC Polyvinylchloride

Cover

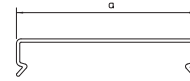

Type	Colour	Dimension a mm	Length mm	Pack. m	Weight kg/100 m	Item No.

PVC Polyvinylchloride

Cover

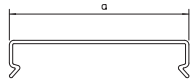

Type	Colour	Dimension a mm	Length mm	Pack. m	Weight kg/100 m	Item No.

PVC Polyvinylchloride

Wiring trunking, type LKV 10037

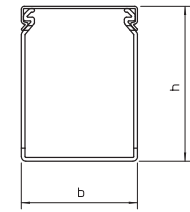

Type	Colour	Dimension a mm	Length mm	W x H mm	Pack. m	Weight kg/100 m	Item No.

PVC Polyvinylchloride

Wiring trunking, type LKV 10050

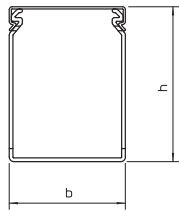

Type	Colour	Length mm	W x H mm	Pack. m	Weight kg/100 m	Item No.

PVC Polyvinylchloride

Cover

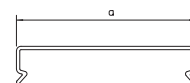
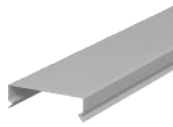

Type	Colour	Dimension a mm	Length mm	Pack. m	Weight kg/100 m	Item No.

PVC Polyvinylchloride

Cover

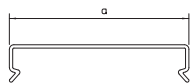
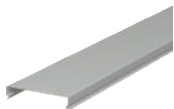

Type	Colour	Dimension a mm	Length mm	Pack. m	Weight kg/100 m	Item No.

PVC Polyvinylchloride

Wiring trunking, type LKV 10075

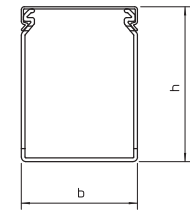

Type	Colour	Length mm	W x H mm	Pack. m	Weight kg/100 m	Item No.

PVC Polyvinylchloride

Wiring duct, type LKV 100100

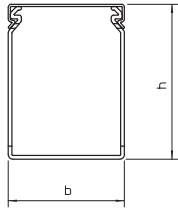

Type	Colour	Length mm	Dimension W x H mm	Pack. m	Weight kg/100 m	Item No.
LKV 100100	Stone grey	2000	100x100	8	116.500	6178341

PVC Polyvinylchloride

Cover

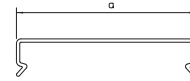
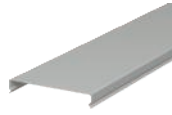

Type	Colour	Dimension a mm	Length mm	Pack. m	Weight kg/100 m	Item No.
LKV D 100	Stone grey	100	2000	12	34.500	6178512

PVC Polyvinylchloride

Wiring trunking, type LKV N 75025

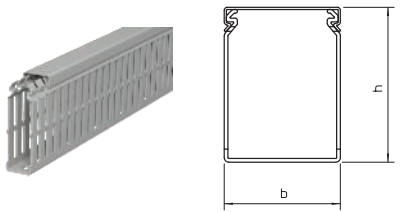

Type	Colour	Length mm	Dimension W x H mm	Pack. m	Weight kg/100 m	Item No.
LKV N 75025	Stone grey	2000	25x75	40	49.500	6178420

PVC Polyvinylchloride

Cover

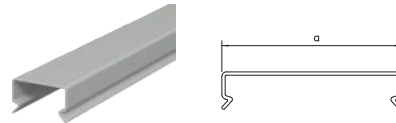

Type	Colour	Dimension a mm	Length mm	Pack. m	Weight kg/100 m	Item No.
LKV D 25	Stone grey	25	2000	36	9.500	6178504

PVC Polyvinylchloride

Cover

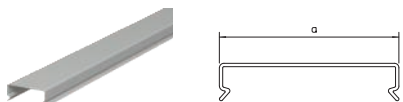

Type	Colour	Dimension a mm	Length mm	Pack. m	Weight kg/100 m	Item No.
LKV D 37	Stone grey	37.5	2000	24	15.000	6178506

PVC Polyvinylchloride

Wiring trunking, type LKV N 75037

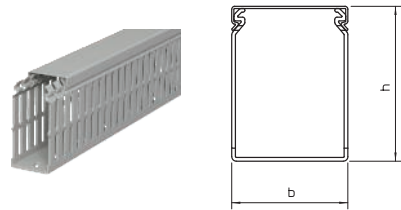

Type	Colour	Length mm	Dimension W x H mm	Pack. m	Weight kg/100 m	Item No.
LKV N 75037	Stone grey	2000	37,5x75	32	60.500	6178422

PVC Polyvinylchloride

Wiring trunking, type LKV N 75050

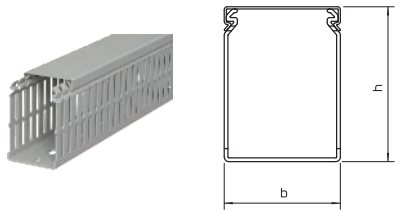

Type	Colour	Length mm	Dimension W x H mm	Pack. m	Weight kg/100 m	Item No.
LKV N 75050	Stone grey	2000	50x75	24	72.500	6178424

PVC Polyvinylchloride

Cover

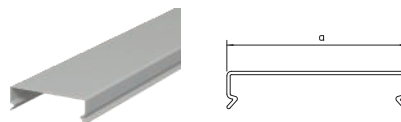

Type	Colour	Dimension a mm	Length mm	Pack. m	Weight kg/100 m	Item No.
LKV D 50	Stone grey	50	2000	24	17.500	6178508

PVC Polyvinylchloride

Cover

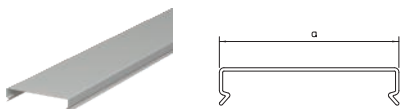

Type	Colour	Dimension a mm	Length mm	Pack. m	Weight kg/100 m	Item No.
LKV D 75	Stone grey	75	2000	12	23.000	6178510

PVC Polyvinylchloride

Wiring trunking, type LKV N 75075

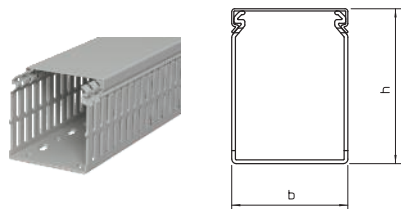

Type	Colour	Length mm	Dimension W x H mm	Pack. m	Weight kg/100 m	Item No.
LKV N 75075	Stone grey	2000	75x75	16	84.500	6178426

PVC Polyvinylchloride

Wiring trunking, type LKV N 75100

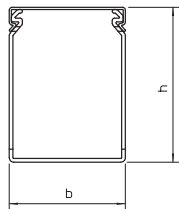

Type	Colour	Length mm	Dimension W x H mm	Pack. m	Weight kg/100 m	Item No.
LKV N 75100	Stone grey	2000	100x75	16	112.000	6178428

PVC Polyvinylchloride

Cover

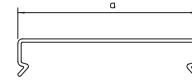

Type	Colour	Dimension a mm	Length mm	Pack. m	Weight kg/100 m	Item No.
LKV D 100	Stone grey	100	2000	12	34.500	6178512

PVC Polyvinylchloride

Cover

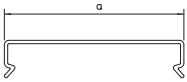

Type	Colour	Dimension a mm	Length mm	Pack. m	Weight kg/100 m	Item No.
LKV D 125	Stone grey	125	2000	16	47.000	6178514

PVC Polyvinylchloride

Wiring trunking, type LKV N 75125

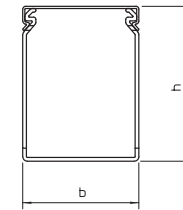

Type	Colour	Length mm	Dimension W x H mm	Pack. m	Weight kg/100 m	Item No.
LKV N 75125	Stone grey	2000	125x75	8	138.500	6178430

PVC Polyvinylchloride

Wiring trunking, type LKV N 10037

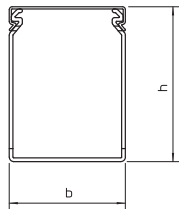

Type	Colour	Length mm	Dimension W x H mm	Pack. m	Weight kg/100 m	Item No.
LKV N 10037	Stone grey	2000	37,5x100	32	73.000	6178435

PVC Polyvinylchloride

Cover

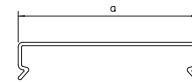

Type	Colour	Dimension a mm	Length mm	Pack. m	Weight kg/100 m	Item No.
LKV D 37	Stone grey	37.5	2000	24	15.000	6178506

PVC Polyvinylchloride

Cover

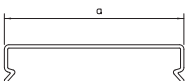
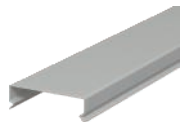

Type	Colour	Dimension a mm	Length mm	Pack. m	Weight kg/100 m	Item No.
LKV D 50	Stone grey	50	2000	24	17.500	6178508

PVC Polyvinylchloride

Wiring trunking, type LKV N 10050

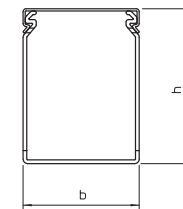

Type	Colour	Length mm	Dimension W x H mm	Pack. m	Weight kg/100 m	Item No.
LKV N 10050	Stone grey	2000	50x100	24	83.000	6178437

PVC Polyvinylchloride

Wiring trunking, type LKV N 10075

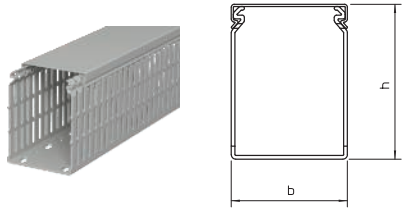

Type	Colour	Length mm	Dimension W x H mm	Pack. m	Weight kg/100 m	Item No.
LKV N 10075	Stone grey	2000	75x100	16	102.000	6178439

PVC Polyvinylchloride

Cover

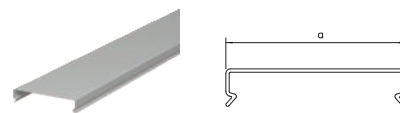

Type	Colour	Dimension a mm	Length mm	Pack. m	Weight kg/100 m	Item No.
LKV D 75	Stone grey	75	2000	12	23.000	6178510

PVC Polyvinylchloride

Cover

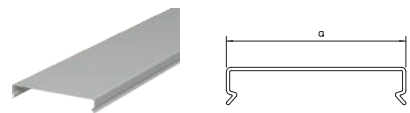

Type	Colour	Dimension a mm	Length mm	Pack. m	Weight kg/100 m	Item No.
LKV D 100	Stone grey	100	2000	12	34.500	6178512

PVC Polyvinylchloride

Wiring duct, type LKV N 100100

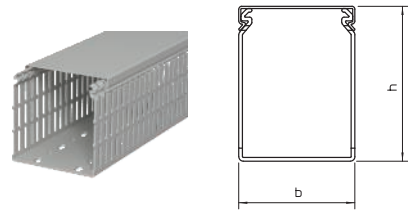

Type	Colour	Length mm	Dimension W x H mm	Pack. m	Weight kg/100 m	Item No.
LKV N 100100	Stone grey	2000	100x100	8	122.500	6178441

PVC Polyvinylchloride

Wire retainer for type LK4 and LK4/N

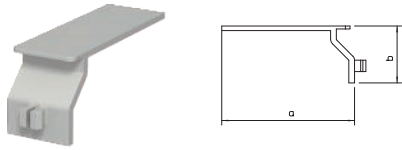

Type	Colour	Dimension a mm	Dimension b mm	Pack. pcs	Weight kg/100 pcs.	Item No.
LK4 H	Stone grey	56	25	100	0.348	6178092

PS Polystyrene

Wire retainer for type LKV and LKV/N

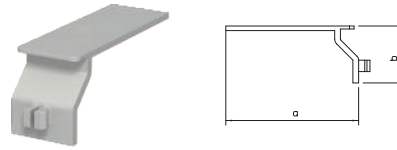

Type	Colour	Dimension a mm	Dimension b mm	Pack. pcs	Weight kg/100 pcs.	Item No.
LKV H	Stone grey	56	25	100	0.343	6178349

PS Polystyrene

Plastic rivet tool

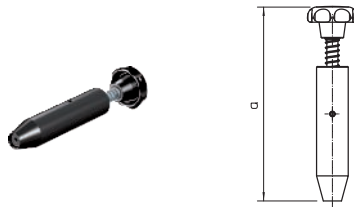

Type	Dimension	Colour	Pack. pcs	Weight kg/100 pcs.	Item No.
KNW1	Ø 4,5mm	Black	1	9.300	6178527

POM Polyacetal (polyoxymethylene, polyformaldehyde)

Plastic rivet tool

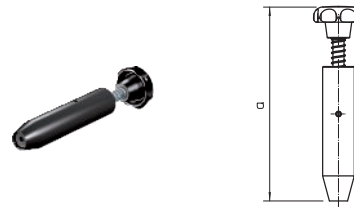

Type	Dimension	Colour	Pack. pcs	Weight kg/100 pcs.	Item No.
KNW2	Ø 6mm	Black	1	9.400	6178529

POM Polyacetal (polyoxymethylene, polyformaldehyde)

Spreading rivet, KSN 1

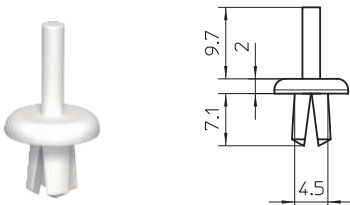

Type	Colour	Pack. pcs	Weight kg/100 pcs.	Item No.
KSN1	Light grey	100	0.026	6178520

PP Polypropylene

Body-bound rivet, KSN 22

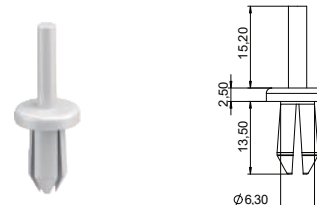

Type	Colour	Pack. pcs	Weight kg/100 pcs.	Item No.
KSN22	Light grey	100	0.070	6178525

PA Polyamide

Release pliers



Type	Pack. pcs	Weight kg/100 pcs.	Item No.
AKZ	1	30.857	6178535

St Steel

Spacer

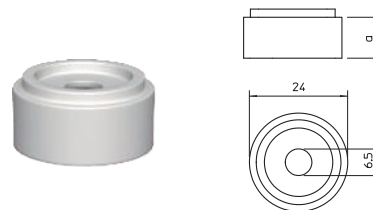

Type	Colour	Dimension a mm	Pack. pcs	Weight kg/100 pcs.	Item No.
AH1	Grey	12	100	0.354	6178540
AH2	Grey	20	100	0.577	6178542

PVC Polyvinylchloride

Washer

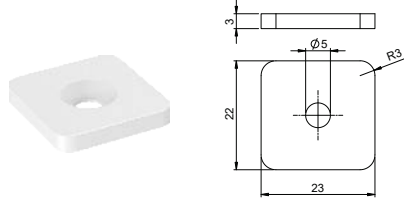

Type	Colour	Dimension h mm	Pack. pcs	Weight kg/100 pcs.	Item No.
ULS	Grey	3	100	0.170	6178548

PVC Polyvinylchloride

Support rail

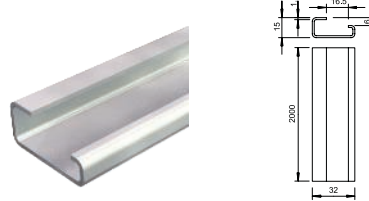

Type	Version	Material thickness mm	Length mm	Bundle m	Weight kg/100 m	Item No.
2064 GTP 2M	Unperforated	1.5	2000	20	70.000	1115057

St Steel
GTP Electrogalvanised, transparently passivated

Support rail

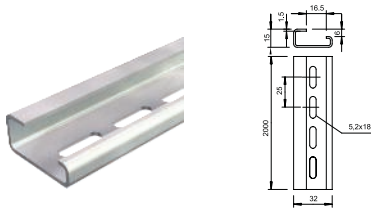

Type	Version	Material thickness mm	Length mm	Bundle m	Weight kg/100 m	Item No.
2064 GTPL 2M	Perforated	1.5	2000	20	69.000	1115065

St Steel
GTP Electrogalvanised, transparently passivated

Hat profile rail, unperforated

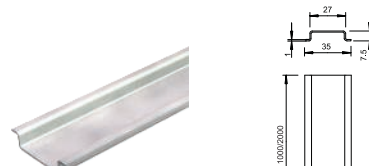

Type	Version	Material thickness mm	Length mm	Bundle m	Weight kg/100 m	Item No.
2069 2M GTP	Unperforated	1	2000	50	36.040	1115650

St Steel
GTP Electrogalvanised, transparently passivated

Identification plate, intrinsically safe circuits

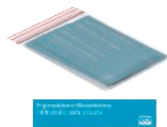

Type	Dimension mm	Colour	Pack. pcs	Weight kg/100 pcs.	Item No.
VK ISCS 5012	99x25mm	Light blue	20	0.100	6178643

Hat profile rail, perforated

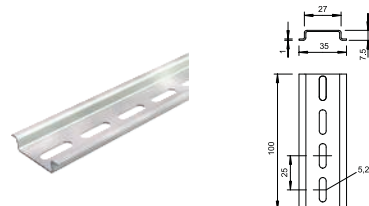

Type	Version	Material thickness mm	Length mm	Bundle m	Weight kg/100 m	Item No.
2069 2M GTPL	Perforated	1	2000	50	33.280	1115669

St Steel
GTP Electrogalvanised, transparently passivated



VKH wiring duct, halogen-free



LKVH DIN wiring trunking, halogen-free

36



Accessories, VK wiring trunking, halogen-free

38

Wiring trunking, type LKV H 50037

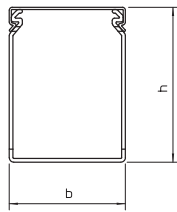

Type	Colour	Dimension		Pack. m	Weight kg/100 m	Item No.
		Length mm	W x H mm			
LKVH 50037	Light grey	2000	37,5 x 50	48	32.000	6178582

PC/ABS Polycarbonate/acrylnitrile-butadiene-styrene

Cover

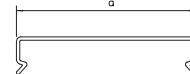

Type	Colour	Dimension a mm	Length mm	Pack. m	Weight kg/100 m	Item No.

PC/ABS Polycarbonate/acrylnitrile-butadiene-styrene

Cover

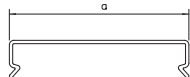

Type	Colour	Dimension a mm	Length mm	Pack. m	Weight kg/100 m	Item No.

PC/ABS Polycarbonate/acrylnitrile-butadiene-styrene

Wiring trunking, type LKV H 50050

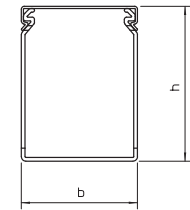

Type	Colour	Dimension a mm	Length mm	Dimension		Pack. m	Weight kg/100 m	Item No.
				W mm	H mm			
LKVH 50050	Light grey	2000	50x50	36	37.000	6178585		

PC/ABS Polycarbonate/acrylnitrile-butadiene-styrene

Wiring trunking, type LKV H 50075

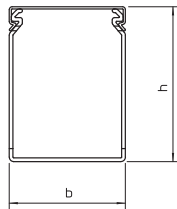

Type	Colour	Length mm	Dimension		Pack. m	Weight kg/100 m	Item No.
			W mm	H mm			
LKVH 50075	Light grey	2000	75x50	24	52.000	6178588	

PC/ABS Polycarbonate/acrylnitrile-butadiene-styrene

Cover

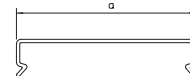

Type	Colour	Dimension a mm	Length mm	Pack. m	Weight kg/100 m	Item No.

PC/ABS Polycarbonate/acrylnitrile-butadiene-styrene

Cover

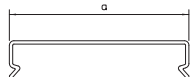

Type	Colour	Dimension a mm	Length mm	Pack. m	Weight kg/100 m	Item No.

PC/ABS Polycarbonate/acrylnitrile-butadiene-styrene

Wiring trunking, type LKV H 75037

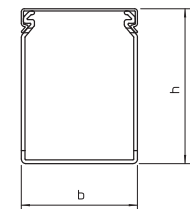

Type	Colour	Length mm	Dimension		Pack. m	Weight kg/100 m	Item No.
			W mm	H mm			
LKVH N 75037	Light grey	2000	37,5 x 75	32	44.000	6178552	

PC/ABS Polycarbonate/acrylnitrile-butadiene-styrene

Wiring trunking, type LKV H 75050

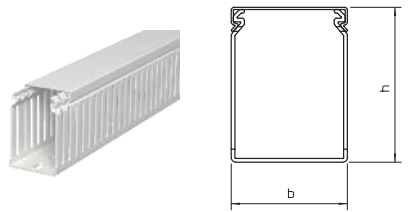

Type	Colour	Dimension		Pack. m	Weight kg/100 m	Item No.
		Length mm	W x H mm			
LKVH N 75050	Light grey	2000	50x75	24	51.000	6178556

PC/ABS Polycarbonate/acrylnitrile-butadiene-styrene

Cover

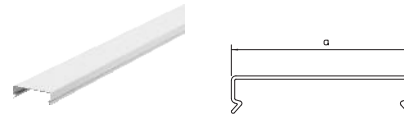

Type	Colour	Dimension a mm	Length mm	Pack. m	Weight kg/100 m	Item No.

PC/ABS Polycarbonate/acrylnitrile-butadiene-styrene

Cover

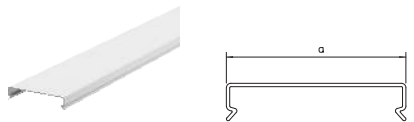

Type	Colour	Dimension a mm	Length mm	Pack. m	Weight kg/100 m	Item No.

PC/ABS Polycarbonate/acrylnitrile-butadiene-styrene

Wiring trunking, type LKV H 75075

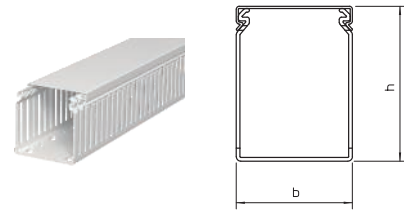

Type	Colour	Dimension		Pack. m	Weight kg/100 m	Item No.
		Length mm	W x H mm			
LKVH N 75075	Light grey	2000	75x75	16	64.000	6178559

PC/ABS Polycarbonate/acrylnitrile-butadiene-styrene

Wiring trunking, type LKV H 75100

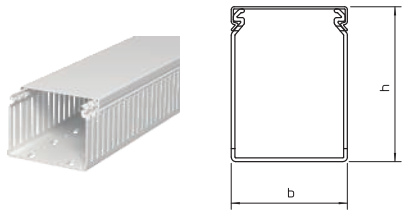

Type	Colour	Dimension		Pack. m	Weight kg/100 m	Item No.
		Length mm	W x H mm			
LKVH N 75100	Light grey	2000	100x75	16	84.000	6178563

PC/ABS Polycarbonate/acrylnitrile-butadiene-styrene

Cover

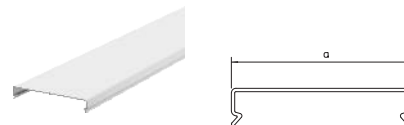

Type	Colour	Dimension a mm	Length mm	Pack. m	Weight kg/100 m	Item No.

PC/ABS Polycarbonate/acrylnitrile-butadiene-styrene

Cover



Type	Colour	Dimension a mm	Length mm	Pack. m	Weight kg/100 m	Item No.

PC/ABS Polycarbonate/acrylnitrile-butadiene-styrene

Wiring trunking, type LKV H 75125

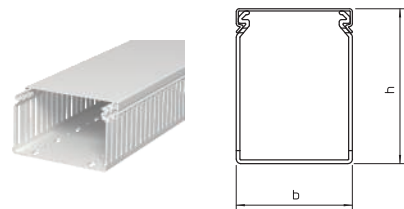

Type	Colour	Dimension		Pack. m	Weight kg/100 m	Item No.
		Length mm	W x H mm			
LKVH N 75125	Light grey	2000	125x75	8	98.500	6178566

PC/ABS Polycarbonate/acrylnitrile-butadiene-styrene

06 LFS Broschüre Verdrahtungskanal 2018_Produttteil_Version EN / en / 2018/10/12 08:17:09 (LLEExport_02462) / 2018/10/12

Wire retainer for type LKV/H

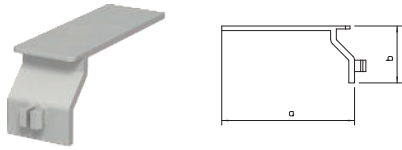

Type	Colour	Dimension a mm	Dimension b mm	Pack. pcs	Weight kg/100 pcs.	Item No.
LKV H H	Light grey	56	25	100	0.349	6178650

PS Polystyrene

Spreading rivet, KSN 1

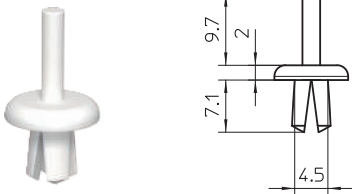

Type	Colour	Pack. pcs	Weight kg/100 pcs.	Item No.
KSN1	Light grey	100	0.026	6178520

PP Polypropylene

Release pliers



Type	Pack. pcs	Weight kg/100 pcs.	Item No.
AKZ	1	30.857	6178535

St Steel

Support rail

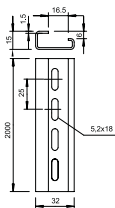

Type	Version	Material thickness mm	Length mm	Bundle m	Weight kg/100 m	Item No.
2064 GTP L 2M	Perforated	1.5	2000	20	69.000	1115065

St Steel

GTP Electrogalvanised, transparently passivated

Plastic rivet tool

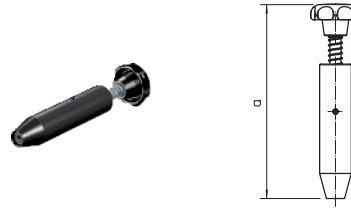

Type	Dimension	Colour	Pack. pcs	Weight kg/100 pcs.	Item No.
KNW1	Ø 4,5mm	Black	1	9.300	6178527

POM Polyacetal (polyoxymethylene, polyformaldehyde)

Plastic rivet tool

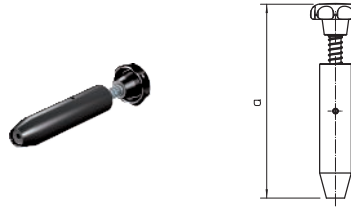

Type	Dimension	Colour	Pack. pcs	Weight kg/100 pcs.	Item No.
KNW2	Ø 6mm	Black	1	9.400	6178529

POM Polyacetal (polyoxymethylene, polyformaldehyde)

Body-bound rivet, KSN 22

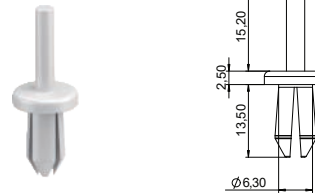

Type	Colour	Pack. pcs	Weight kg/100 pcs.	Item No.
KSN22	Light grey	100	0.070	6178525

PA Polyamide

Support rail

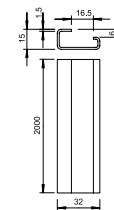
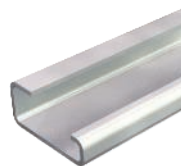

Type	Version	Material thickness mm	Length mm	Bundle m	Weight kg/100 m	Item No.
2064 GTP 2M	Unperforated	1.5	2000	20	70.000	1115057

St Steel

GTP Electrogalvanised, transparently passivated

Hat profile rail, unperforated

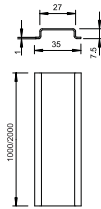

Material thickness	Length	Bundle	Weight
mm	mm	m	kg/100 m
1	2000	50	36.040

Type	Version	Material	Item No.
2069 2M GTP	Unperforated	St	1115650

St Steel

GTP Electrogalvanised, transparently passivated

Hat profile rail, perforated

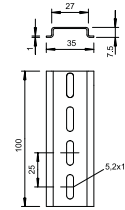

Material thickness	Length	Bundle	Weight	Item N
mm	mm	m	kg/100 m	
1	2000	50	33.280	11156

Type	Version	Material	Item No.
2069 2M GTPL	Perforated	St	1115650

St Steel

GTP Electrogalvanised, transparently passivated

OBO Bettermann Holding GmbH & Co. KG
P.O. Box 1120
58694 Menden
GERMANY

Customer Service
Tel.: +49 23 73 89 - 17 00
Fax: +49 23 73 89 - 12 38
export@obo.de

www.obo-bettermann.com

Building Connections

