

LED DOWNLIGHT

Product&Family Code: 016 017 0015

AMANDA-15

Technical Drawing

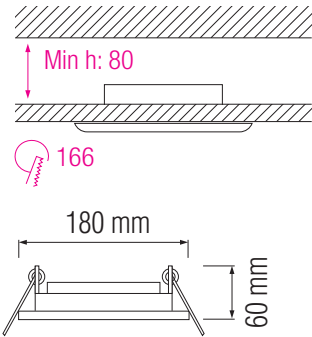

Photometric Diagram

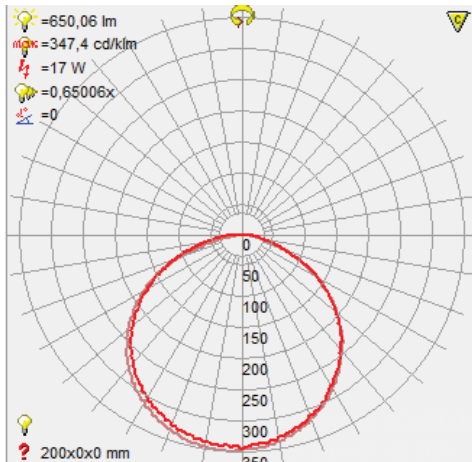

Technical Data

Voltage (V)	220-240V
Product Wattage (W)	15
Equivalence with incandescent lamp	144
Colour Render Index (Ra)	>Ra80
Colour Temperature (K)	3000K / 6400K
Materials	Aluminium Die Casting Body
Protection Class	II
Dimmable	No
EEI	A to A++
Warm-up time up to 60 % of the full light output	Instant Full Light
Luminous Flux (lm)	650
Luminous Efficacy (lm/W)	43
Rated Life (hrs) ⌚	30.000
IP Rating	20
Power Factor	>0.5
Beam Angle	120°
Starting Time	<0.2s
Number of ON-OFF cycling	x25.000

Applications

- Airport, Bathroom, Bedroom, Car Park, Cinema, Gallery, Hospital, Hotel, Kitchen, Museum etc.



Features

- High Lumen and CRI, Good quality & Constant Current driver.
- High heat dissipation, low carbon and environmental protection.
- SMD LED Lamp Base.
- Aluminum Die Casting Body

