

Legend:
L/W - Outer size
H - Height of the downlight
L1/W1 - Size of the cut

QUAD



Model	Watt	Whole fixture lumens (lm)	Colour temp. (K)	Colour body	Size (mm)					Catalogue number	Packing (pcs)
					L	W	H	L1	W1		
QUAD110	10W	700	4000K	white	190	190	145	165	165	92Q11040WH	20
QUAD110	10W	700	2700K	white	190	190	145	165	165	92Q11027WH	20
QUAD110	10W	700	4000K	silver	190	190	145	165	165	92Q11040SLV	20
QUAD110	10W	700	2700K	silver	190	190	145	165	165	92Q11027SLV	20
QUAD110	10W	700	4000K	dark grey	190	190	145	165	165	92Q11040DGR	20
QUAD110	10W	700	2700K	dark grey	190	190	145	165	165	92Q11027DGR	20
QUAD210	2X10W	1400	4000K	white	340	190	145	315	165	92Q21040WH	20
QUAD210	2X10W	1400	2700K	white	340	190	145	315	165	92Q21027WH	20
QUAD210	2X10W	1400	4000K	silver	340	190	145	315	165	92Q21040SLV	20
QUAD210	2X10W	1400	2700K	silver	340	190	145	315	165	92Q21027SLV	20
QUAD210	2X10W	1400	4000K	dark grey	340	190	145	315	165	92Q21040DGR	20
QUAD210	2X10W	1400	2700K	dark grey	340	190	145	315	165	92Q21027DGR	20
QUAD310	3X10W	2100	4000K	white	490	190	145	465	165	92Q31040WH	20
QUAD310	3X10W	2100	2700K	white	490	190	145	465	165	92Q31027WH	20
QUAD310	3X10W	2100	4000K	silver	490	190	145	465	165	92Q31040SLV	20
QUAD310	3X10W	2100	2700K	silver	490	190	145	465	165	92Q31027SLV	20
QUAD310	3X10W	2100	4000K	dark grey	490	190	145	465	165	92Q31040DGR	20
QUAD310	3X10W	2100	2700K	dark grey	490	190	145	465	165	92Q31027DGR	20

Body: aluminium | **Light source:** LED lamp PAR30
LED recessed downlight. Easy installation due to handy clips.



LED INTERIOR LIGHTING

LED Accent lighting



QUAD610



QUAD410

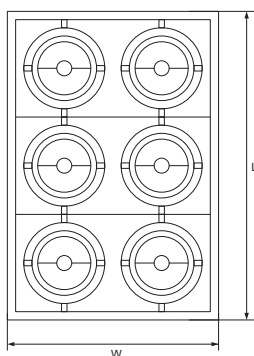
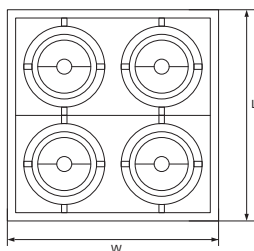
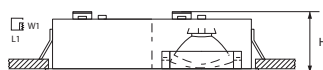

Legend:
L/W - Outer size
H - Height of the downlight
L1/W1 - Size of the cut

QUAD



Model	Watt	Whole fixture lumens (lm)	Colour temp. (K)	Colour body	Size (mm)					Catalogue number	Packing (pcs)
					L	W	H	L1	W1		
QUAD410	4X10W	2800	4000K	white	340	340	145	315	315	92Q41040WH	6
QUAD410	4X10W	2800	2700K	white	340	340	145	315	315	92Q41027WH	6
QUAD410	4X10W	2800	4000K	silver	340	340	145	315	315	92Q41040SLV	6
QUAD410	4X10W	2800	2700K	silver	340	340	145	315	315	92Q41027SLV	6
QUAD410	4X10W	2800	4000K	dark grey	340	340	145	315	315	92Q41040DGR	6
QUAD410	4X10W	2800	2700K	dark grey	340	340	145	315	315	92Q41027DGR	6
QUAD610	6X10W	4200	4000K	white	490	340	145	465	315	92Q61040WH	4
QUAD610	6X10W	4200	2700K	white	490	340	145	465	315	92Q61027WH	4
QUAD610	6X10W	4200	4000K	silver	490	340	145	465	315	92Q61040SLV	4
QUAD610	6X10W	4200	2700K	silver	490	340	145	465	315	92Q61027SLV	4
QUAD610	6X10W	4200	4000K	dark grey	490	340	145	465	315	92Q61040DGR	4
QUAD610	6X10W	4200	2700K	dark grey	490	340	145	465	315	92Q61027DGR	4

Body: aluminium | **Light source:** LED lamp PAR30
LED recessed downlight. Easy installation due to handy clips.





QUAD312

QUAD212

QUAD112

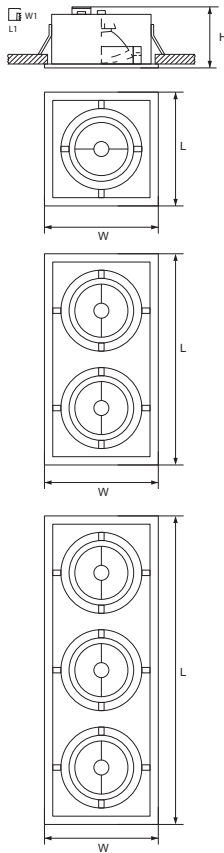

Legend:
L/W - Outer size
H - Height of the downlight
L1/W1 - Size of the cut

QUAD



Model	Watt	Whole fixture lumens (lm)	Colour temp. (K)	Colour body	Size (mm)					Catalogue number	Packing (pcs)
					L	W	H	L1	W1		
QUAD112	12W	900	4000K	white	190	190	145	165	165	92Q11240WH	20
QUAD112	12W	900	2700K	white	190	190	145	165	165	92Q11227WH	20
QUAD112	12W	900	4000K	silver	190	190	145	165	165	92Q11240SLV	20
QUAD112	12W	900	2700K	silver	190	190	145	165	165	92Q11227SLV	20
QUAD112	12W	900	4000K	dark grey	190	190	145	165	165	92Q11240DGR	20
QUAD112	12W	900	2700K	dark grey	190	190	145	165	165	92Q11227DGR	20
QUAD212	2X12W	1800	4000K	white	340	190	145	315	165	92Q21240WH	20
QUAD212	2X12W	1800	2700K	white	340	190	145	315	165	92Q21227WH	20
QUAD212	2X12W	1800	4000K	silver	340	190	145	315	165	92Q21240SLV	20
QUAD212	2X12W	1800	2700K	silver	340	190	145	315	165	92Q21227SLV	20
QUAD212	2X12W	1800	4000K	dark grey	340	190	145	315	165	92Q21240DGR	20
QUAD212	2X12W	1800	2700K	dark grey	340	190	145	315	165	92Q21227DGR	20
QUAD312	3X12W	2700	4000K	white	490	190	145	465	165	92Q31240WH	20
QUAD312	3X12W	2700	2700K	white	490	190	145	465	165	92Q31227WH	20
QUAD312	3X12W	2700	4000K	silver	490	190	145	465	165	92Q31240SLV	20
QUAD312	3X12W	2700	2700K	silver	490	190	145	465	165	92Q31227SLV	20
QUAD312	3X12W	2700	4000K	dark grey	490	190	145	465	165	92Q31240DGR	20
QUAD312	3X12W	2700	2700K	dark grey	490	190	145	465	165	92Q31227DGR	20

Body: aluminium | **Light source:** LED lamp PAR30
LED recessed downlight. Easy installation due to handy clips.

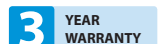

LED INTERIOR LIGHTING

LED Accent lighting



QUAD612



QUAD412

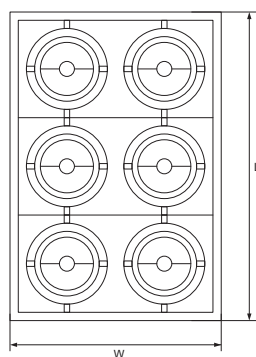
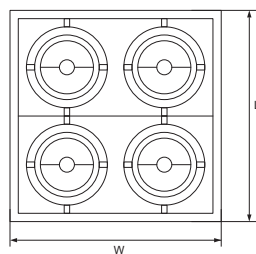
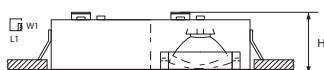

Legend:
L/W - Outer size
H - Height of the downlight
L1/W1 - Size of the cut

QUAD



Model	Watt	Whole fixture lumens (lm)	Colour temp. (K)	Colour body	Size (mm)					Catalogue number	Packing (pcs)
					L	W	H	L1	W1		
QUAD412	4X12W	3600	4000K	white	340	340	145	315	315	92Q41240WH	6
QUAD412	4X12W	3600	2700K	white	340	340	145	315	315	92Q41227WH	6
QUAD412	4X12W	3600	4000K	silver	340	340	145	315	315	92Q41240SLV	6
QUAD412	4X12W	3600	2700K	silver	340	340	145	315	315	92Q41227SLV	6
QUAD412	4X12W	3600	4000K	dark grey	340	340	145	315	315	92Q41240DGR	6
QUAD412	4X12W	3600	2700K	dark grey	340	340	145	315	315	92Q41227DGR	6
QUAD612	6X12W	5400	4000K	white	490	340	145	465	315	92Q61240WH	4
QUAD612	6X12W	5400	2700K	white	490	340	145	465	315	92Q61227WH	4
QUAD612	6X12W	5400	4000K	silver	490	340	145	465	315	92Q61240SLV	4
QUAD612	6X12W	5400	2700K	silver	490	340	145	465	315	92Q61227SLV	4
QUAD612	6X12W	5400	4000K	dark grey	490	340	145	465	315	92Q61240DGR	4
QUAD612	6X12W	5400	2700K	dark grey	490	340	145	465	315	92Q61227DGR	4

Body: aluminium | **Light source:** LED lamp PAR30
LED recessed downlight. Easy installation due to handy clips.





LED INTERIOR LIGHTING

LED DOWNLIGHT FIXTURES

282

LED Downlight fixtures

Drivers features:

- Easy installation
- Low consumption
- Strong compatibility
- Compliance to worldwide safety regulations for lighting
- Certificate: CE, ROHS, EMC, LVD
- Type: constant current (CC/IC)
- Structure: isolated

- International broad voltage AC input
- Protection: electric shock
- Natural air cooled
- 100% full-load aged
- Working temperature up to 65°C
- High efficiency, long life span, and high reliability



LED INTERIOR LIGHTING

LED Downlight fixtures

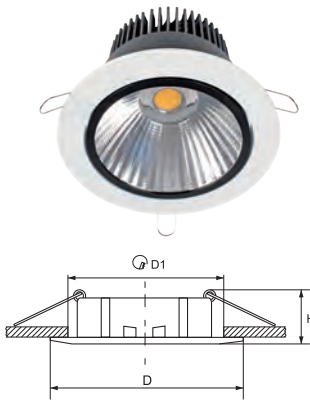

Legend:
D - Outer diameter
H - Height of the downlight
D1 - Diameter of the cut

RDL60COB

A++ A IP20 RoHS EMC F CE

Watt	LED chip lumens (lm)	Whole fixture lumens (lm)	Colour temp. (K)	Colour body	Size (mm)			Catalogue number	Packing (pcs)
					D	L	D1		
20W	2200	1600	4000-4300	black/white	140	77	120	92DL62040	18
20W	2200	1600	2700-3000	black/white	140	77	120	92DL62027	18

Body: aluminium | **Diffuser:** glass | **Light source:** Epistar | **Power factor:** $\lambda > 0.9$ | **Starting time:** <0.5s
LED recessed round downlight COB. Easy installation due to handy clips.

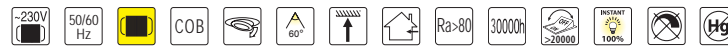

5 YEAR WARRANTY

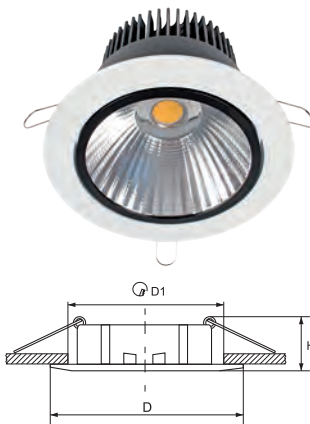

Legend:
D - Outer diameter
H - Height of the downlight
D1 - Diameter of the cut

RDL60COB

A++ A IP20 RoHS EMC F CE

Watt	LED chip lumens (lm)	Whole fixture lumens (lm)	Colour temp. (K)	Colour body	Size (mm)			Catalogue number	Packing (pcs)
					D	L	D1		
30W	3300	2400	4000-4300	black/white	160	110	140	92DL63040	12
30W	3300	2400	2700-3000	black/white	160	110	140	92DL63027	12

Body: aluminium | **Diffuser:** glass | **Light source:** Epistar | **Power factor:** $\lambda > 0.9$ | **Starting time:** <0.5s
LED recessed round downlight COB. Easy installation due to handy clips.

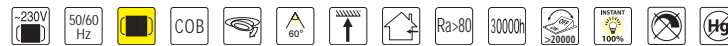

5 YEAR WARRANTY

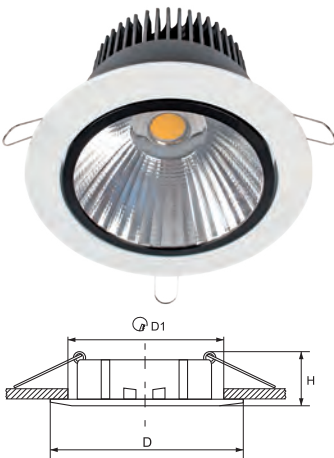

Legend:
D - Outer diameter
H - Height of the downlight
D1 - Diameter of the cut

RDL60COB

A++ A IP20 RoHS EMC F CE

Watt	LED chip lumens (lm)	Whole fixture lumens (lm)	Colour temp. (K)	Colour body	Size (mm)			Catalogue number	Packing (pcs)
					D	L	D1		
40W	4400	3200	4000-4300	black/white	160	110	140	92DL64040	12
40W	4400	3200	2700-3000	black/white	160	110	140	92DL64027	123

Body: aluminium | **Diffuser:** glass | **Light source:** Epistar | **Power factor:** $\lambda > 0.9$ | **Starting time:** <0.5s
LED recessed round downlight COB. Easy installation due to handy clips.

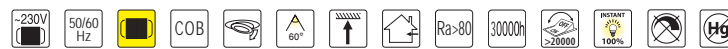

5 YEAR WARRANTY

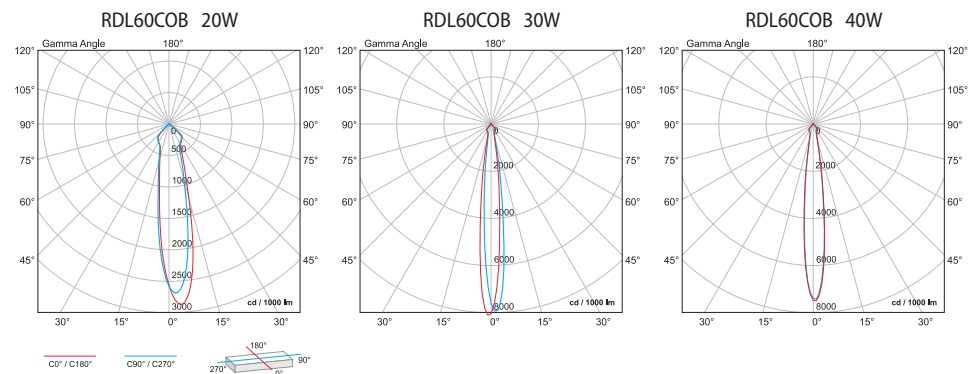

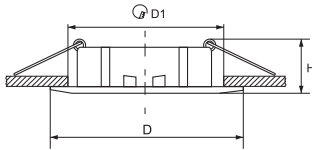

Legend:
D - Outer diameter
H - Height of the downlight
D1 - Diameter of the cut

RDLCOB



Watt	LED chip lumens (lm)	Whole fixture lumens (lm)	Colour temp. (K)	Colour body	Size (mm)			Catalogue number	Packing (pcs)
					D	H	D1		
10W	1100	800	4000-4300	white	128	45	113	92DLC1040/WH	30
10W	1100	800	2700-3000	white	128	45	113	92DLC1027/WH	30
10W	1100	800	4000-4300	satın nickel	128	45	113	92DLC1040/SN	30
10W	1100	800	2700-3000	satın nickel	128	45	113	92DLC1027/SN	30

Body: aluminium | **Diffuser:** glass | **Light source:** Epistar
Power factor: $\lambda > 0.9$ | **Starting time:** $< 0.5s$ | LED recessed round downlight COB. Easy installation due to handy clips.

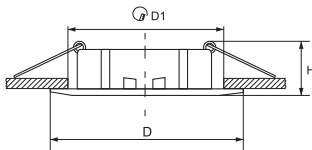
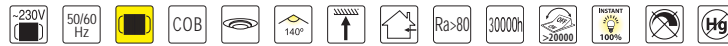

Legend:
D - Outer diameter
H - Height of the downlight
D1 - Diameter of the cut

RDLCOB



Watt	LED chip lumens (lm)	Whole fixture lumens (lm)	Colour temp. (K)	Colour body	Size (mm)			Catalogue number	Packing (pcs)
					D	H	D1		
15W	1650	1200	4000-4300	white	165	50	150	92DLC1540/WH	30
15W	1650	1200	2700-3000	white	165	50	150	92DLC1527/WH	30
15W	1650	1200	4000-4300	satın nickel	165	50	150	92DLC1540/SN	30
15W	1650	1200	2700-3000	satın nickel	165	50	150	92DLC1527/SN	30

Body: aluminium | **Diffuser:** glass | **Light source:** Epistar
Power factor: $\lambda > 0.9$ | **Starting time:** $< 0.5s$ | LED recessed round downlight COB. Easy installation due to handy clips.

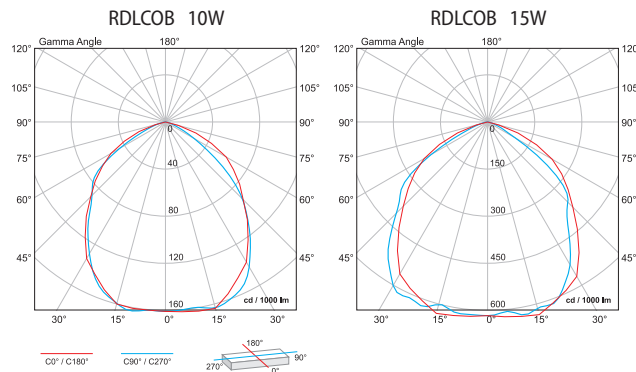

LED INTERIOR LIGHTING

LED Downlight fixtures

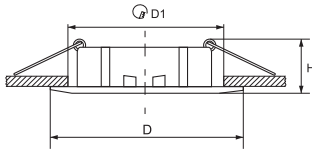

Legend:
D - Outer diameter
H - Height of the downlight
D1 - Diameter of the cut

RDLCOB



Watt	LED chip lumens (lm)	Whole fixture lumens (lm)	Colour temp. (K)	Colour body	Size (mm)			Catalogue number	Packing (pcs)
					D	H	D1		
25W	2750	2000	4000-4300	white	190	60	175	92DLC2540/WH	30
25W	2750	2000	2700-3000	white	190	60	175	92DLC2527/WH	30
25W	2750	2000	4000-4300	satin nickel	190	60	175	92DLC2540/SN	30
25W	2750	2000	2700-3000	satin nickel	190	60	175	92DLC2527/SN	30

Body: aluminium | **Diffuser:** glass | **Light source:** Epistar
Power factor: $\lambda > 0.9$ | **Starting time:** $< 0.5s$ | LED recessed round downlight COB. Easy installation due to handy clips.



white satin nickel

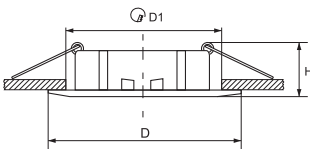
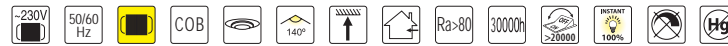

Legend:
D - Outer diameter
H - Height of the downlight
D1 - Diameter of the cut

RDLCOB



Watt	LED chip lumens (lm)	Whole fixture lumens (lm)	Colour temp. (K)	Colour body	Size (mm)			Catalogue number	Packing (pcs)
					D	H	D1		
30W	3300	2400	4000-4300	white	230	97	215	92DLC3040/WH	30
30W	3300	2400	2700-3000	white	230	97	215	92DLC3027/WH	30
30W	3300	2400	4000-4300	satin nickel	230	97	215	92DLC3040/SN	30
30W	3300	2400	2700-3000	satin nickel	230	97	215	92DLC3027/SN	30

Body: aluminium | **Diffuser:** glass | **Light source:** Epistar
Power factor: $\lambda > 0.9$ | **Starting time:** $< 0.5s$ | LED recessed round downlight COB. Easy installation due to handy clips.



white satin nickel

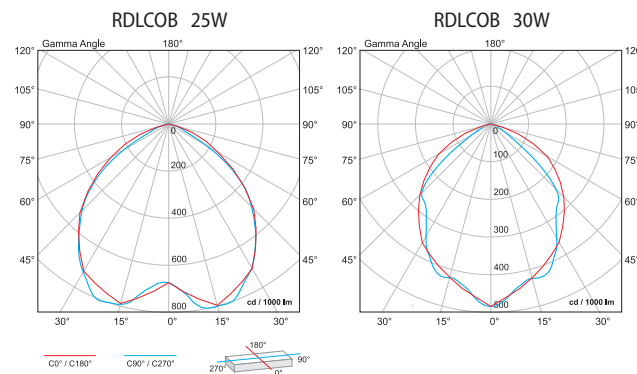
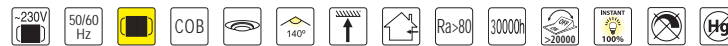

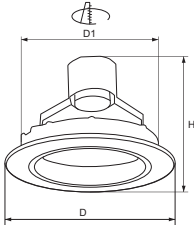

Legend:
D - Outer diameter
H - Height of the downlight
D1 - Diameter of the cut

GL106LED



Watt	LED chip lumens (lm)	Whole fixture lumens (lm)	Colour temp. (K)	Colour body	Size (mm)			Catalogue number	Packing (pcs)
					D	H	D1		
12W	1440	900	4000	white	160	145	140	93GL106540	1
12W	1440	900	2700	white	160	145	140	93GL106527	1

Body: aluminium | **Light source:** Epistar | LED recessed round downlight COB. Easy installation due to handy clips.

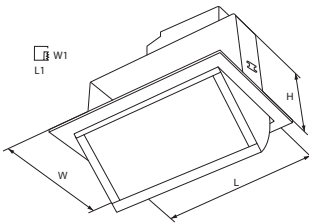

Legend:
L/W - Outer size
H - Height of the downlight
L1/W1 - Size of the cut

QDL2COB



Watt	LED chip lumens (lm)	Whole fixture lumens (lm)	Colour temp. (K)	Colour body	Size (mm)					Catalogue number	Packing (pcs)
					L	W	H	L1	W1		
30W	3600	2400	4000-4300	white	230	145	140	220	135	92QDL123040	6
40W	4800	3200	4000-4300	white	230	145	140	220	135	92QDL124040	6

Body: aluminium | **Diffuser:** glass | **Light source:** Epistar | **Power factor:** $\lambda > 0.9$ | **Starting time:** <0.5s
LED recessed round downlight COB. Easy installation due to handy clips.

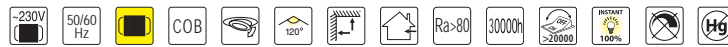

QDL2COB 30W

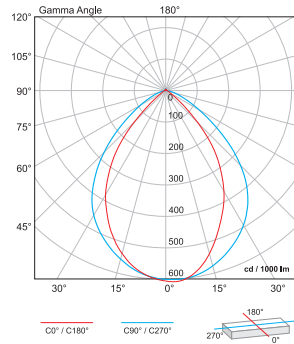

QDL2COB 40W

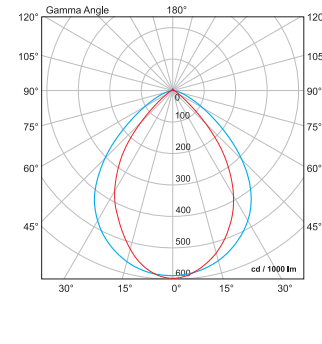

LED INTERIOR LIGHTING

LED Downlight fixtures

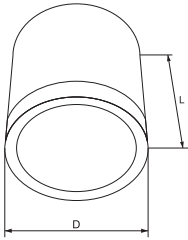

RDLOMCOB



Watt	LED chip lumens (lm)	Whole fixture lumens (lm)	Colour temp. (K)	Colour body	Size (mm)		Catalogue number	Packing (pcs)
					D	L		
10W	1200	800	4000-4300	white	95	70	92DLOM1040/WH	24
10W	1200	800	2700-3000	white	95	70	92DLOM1027/WH	24
10W	1200	800	4000-4300	silver	95	70	92DLOM1040/S	24
10W	1200	800	2700-3000	silver	95	70	92DLOM1027/S	24

Body: aluminium | **Light source:** Epistar
Power factor: $\lambda > 0.9$ | **Starting time:** $< 0.5s$
 LED surface round downlight COB.

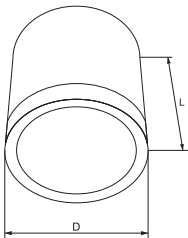
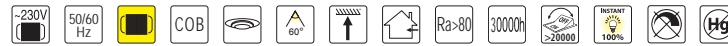

RDLOMCOB



Watt	LED chip lumens (lm)	Whole fixture lumens (lm)	Colour temp. (K)	Colour body	Size (mm)		Catalogue number	Packing (pcs)
					D	L		
20W	2400	1600	4000-4300	white	95	110	92DLOM2040/WH	12
20W	2400	1600	2700-3000	white	95	110	92DLOM2027/WH	12
20W	2400	1600	4000-4300	silver	95	110	92DLOM2040/S	12
20W	2400	1600	2700-3000	silver	95	110	92DLOM2027/S	12

Body: aluminium | **Light source:** Epistar
Power factor: $\lambda > 0.9$ | **Starting time:** $< 0.5s$
 LED surface round downlight COB.

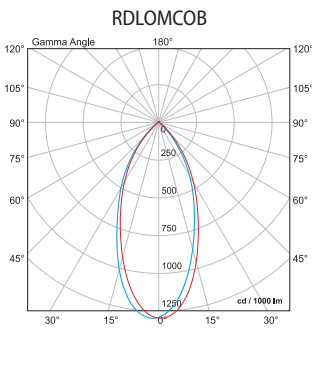
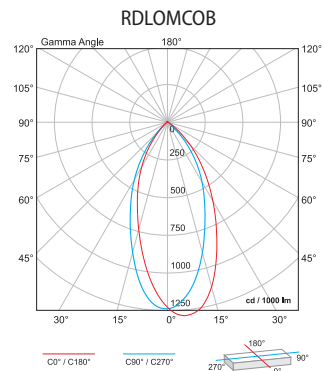
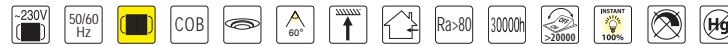

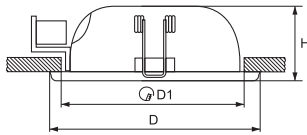

Legend:
D - Outer diameter
H - Height of the downlight
D1 - Diameter of the cut

GL201LED

A+ A++ A IP 20 RoHS EMC F CE

Watt	Whole fixture lumens (lm)	Colour temp. (K)	Colour body	Size (mm)			Catalogue number	Packing (pcs)
				D	H	D1		
2X10W	1600	4000	white	226	110	210	92201LED01	1
2X10W	1600	2700	white	226	110	210	92201LED03	1
2X10W	1600	4000	satın nickel	226	110	210	92201LED02	1
2X10W	1600	2700	satın nickel	226	110	210	92201LED04	1

Body: aluminium alloy | **Light source:** LED lamp PLC | LED recessed round downlight. Easy installation due to handy clips. Lumens of the LED lamps (lm): 10W - 890lm; 15W - 1360lm.

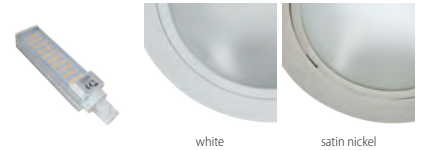

3 YEAR WARRANTY

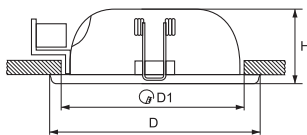

Legend:
D - Outer diameter
H - Height of the downlight
D1 - Diameter of the cut

GL201LED

A+ A++ A IP 20 RoHS EMC F CE

Watt	Whole fixture lumens (lm)	Colour temp. (K)	Colour body	Size (mm)			Catalogue number	Packing (pcs)
				D	H	D1		
2X15W	2400	4000	white	226	110	210	92201LED05	1
2X15W	2400	2700	white	226	110	210	92201LED07	1
2X15W	2400	4000	satın nickel	226	110	210	92201LED06	1
2X15W	2400	2700	satın nickel	226	110	210	92201LED08	1

Body: aluminium alloy | **Light source:** LED lamp PLC | LED recessed round downlight. Easy installation due to handy clips. Lumens of the LED lamps (lm): 10W - 890lm; 15W - 1360lm.

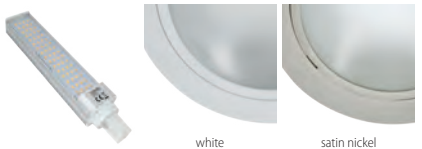

3 YEAR WARRANTY

LED INTERIOR LIGHTING

LED Downlight fixtures

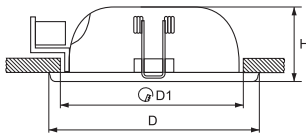

Legend:
D - Outer diameter
H - Height of the downlight
D1 - Diameter of the cut

GL210LED



Watt	Whole fixture lumens (lm)	Colour temp. (K)	Colour body	Size (mm)			Catalogue number	Packing (pcs)
				D	H	D1		
2X10W	1600	4000	white	228	110	210	92210LED01	1
2X10W	1600	2700	white	228	110	210	92210LED03	1
2X10W	1600	4000	satın nickel	228	110	210	92210LED02	1
2X10W	1600	2700	satın nickel	228	110	210	92210LED04	1

Body: aluminium alloy | **Light source:** LED lamp PLC | LED recessed round downlight. Easy installation due to handy clips. Lumens of the LED lamps (lm): 10W - 890lm; 15W - 1360lm.

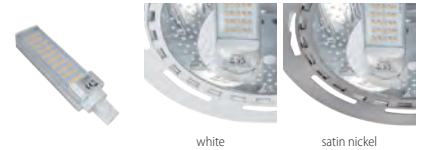

3 YEAR WARRANTY

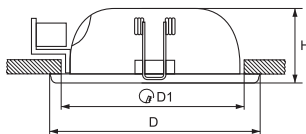

Legend:
D - Outer diameter
H - Height of the downlight
D1 - Diameter of the cut

GL210LED



Watt	Whole fixture lumens (lm)	Colour temp. (K)	Colour body	Size (mm)			Catalogue number	Packing (pcs)
				D	H	D1		
2X15W	2400	4000	white	228	110	210	92210LED05	1
2X15W	2400	2700	white	228	110	210	92210LED07	1
2X15W	2400	4000	satın nickel	228	110	210	92210LED06	1
2X15W	2400	2700	satın nickel	228	110	210	92210LED08	1

Body: aluminium alloy | **Light source:** LED lamp PLC | LED recessed round downlight. Easy installation due to handy clips. Lumens of the LED lamps (lm): 10W - 890lm; 15W - 1360lm.



3 YEAR WARRANTY

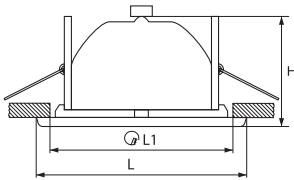

Legend:
L=W - Outer length
H - Height of the downlight
L1=W1 - Length of the cut

GL204LED



Watt	Whole fixture lumens (lm)	Colour temp. (K)	Colour body	Size (mm)			Catalogue number	Packing (pcs)
				L=W	H	L1=W1		
2X10W	1600	4000	white	230	110	210	92204LED01	1
2X10W	1600	2700	white	230	110	210	92204LED03	1
2X10W	1600	4000	satın nickel	230	110	210	92204LED02	1
2X10W	1600	2700	satın nickel	230	110	210	92204LED04	1

Body: aluminium alloy | **Light source:** LED lamp PLC | LED recessed square downlight. Easy installation due to handy clips. Lumens of the LED lamps (lm): 10W - 890lm; 15W - 1360lm.

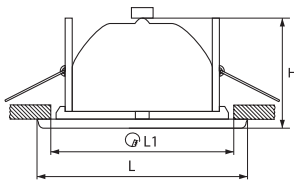

Legend:
L=W - Outer length
H - Height of the downlight
L1=W1 - Length of the cut

GL204LED



Watt	Whole fixture lumens (lm)	Colour temp. (K)	Colour body	Size (mm)			Catalogue number	Packing (pcs)
				L=W	H	L1=W1		
2X15W	2400	4000	white	230	110	210	92204LED05	1
2X15W	2400	2700	white	230	110	210	92204LED07	1
2X15W	2400	4000	satın nickel	230	110	210	92204LED06	1
2X15W	2400	2700	satın nickel	230	110	210	92204LED08	1

Body: aluminium alloy | **Light source:** LED lamp PLC | LED recessed square downlight. Easy installation due to handy clips. Lumens of the LED lamps (lm): 10W - 890lm; 15W - 1360lm.



LED INTERIOR LIGHTING

LED Downlight fixtures

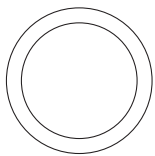
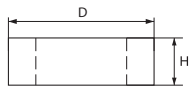

GL213LED



Watt	Whole fixture lumens (lm)	Colour temp. (K)	Colour body	Size (mm)		Catalogue number	Packing (pcs)
				D	H		
2X10W	1600	4000	white	266	65	92213LED01	1
2X10W	1600	2700	white	266	65	92213LED03	1
2X10W	1600	4000	satın nickel	266	65	92213LED02	1
2X10W	1600	2700	satın nickel	266	65	92213LED04	1

Body: aluminium alloy | **Light source:** LED lamp PLC | LED surface round downlight. Lumens of the LED lamps (lm): 10W - 890lm; 15W - 1360lm.



white

satın nickel

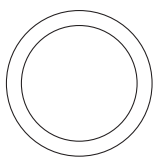

GL213LED



Watt	Whole fixture lumens (lm)	Colour temp. (K)	Colour body	Size (mm)		Catalogue number	Packing (pcs)
				D	H		
2X15W	2400	4000	white	266	65	92213LED05	1
2X15W	2400	2700	white	266	65	92213LED07	1
2X15W	2400	4000	satın nickel	266	65	92213LED06	1
2X15W	2400	2700	satın nickel	266	65	92213LED08	1

Body: aluminium alloy | **Light source:** LED lamp PLC | LED surface round downlight. Lumens of the LED lamps (lm): 10W - 890lm; 15W - 1360lm.



white

satın nickel

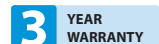

INTERIOR LIGHTING

Downlights for bathroom

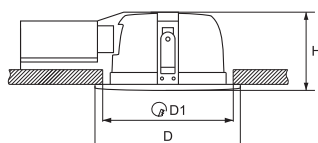

Legend:
D - Outer diameter
H - Height of the spotlight
D1 - Diameter of the cut

GL102 - 5



Model	Watt	Size (mm)			Colour body	Catalogue number	Packing (pcs)
		Diameter	Height	Diameter 1			
GL102 - 5	2X13W	168	100	150	white	9299441025/W	12
GL102 - 5	2X13W	168	100	150	satın nickel	9299441025/TCH	12



5 YEAR WARRANTY

Body: steel | **Diffuser:** glass with matt round | **Ring:** aluminium



white satin nickel

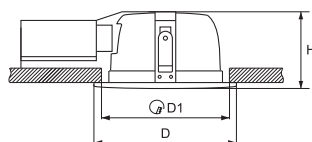

Legend:
D - Outer diameter
H - Height of the spotlight
D1 - Diameter of the cut

GL103E



Model	Size (mm)			Colour body	Catalogue number	Packing (pcs)
	Diameter	Height	Diameter 1			
GL103E	190	100	170	white	929944103E/W	12
GL103E	190	100	170	satın nickel	929944103E/TCH	12



5 YEAR WARRANTY

Body: steel | **Diffuser:** glass with matt round | **Ring:** aluminium



white satin nickel

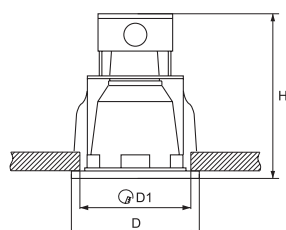

Legend:
D - Outer diameter
H - Height of the spotlight
D1 - Diameter of the cut

GL 120E



Model	Size (mm)			Colour body	Catalogue number	Packing (pcs)
	Diameter	Height	Diameter 1			
GL120E-4	140	165	120	white	929944120E4/W	40
GL120E-4	140	165	120	satın nickel	929944120E4/TCH	40
GL120E-6	190	200	170	white	929944120E6/W	24
GL120E-6	190	200	170	satın nickel	929944120E6/TCH	24



5 YEAR WARRANTY

Body: steel | **Diffuser:** glass with matt round | **Ring:** aluminium



white satin nickel

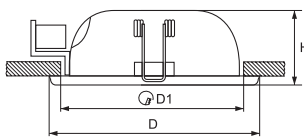

Legend:
D - Outer diameter
H - Height of the spotlight
D1 - Diameter of the cut

GL 201E



Model	Size (mm)			Colour body	Catalogue number	Packing (pcs)
	Diameter	Height	Diameter 1			
GL 201E	226	110	210	white	9299201E/W	12
GL 201E	226	110	210	satın nickel	9299201E/SN	12



GL 201



Model	Size (mm)			Colour body	Catalogue number	Packing (pcs)
	Diameter	Height	Diameter 1			
GL 201	226	110	210	white	9299201P/W	12
GL 201	226	110	210	satın nickel	9299201P/SN	12



Body: steel | **Diffuser:** matt glass | **Ring:** aluminium alloy |
Reflector: aluminium mirror

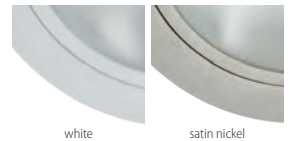

GL 202E



Model	Size (mm)			Colour body	Catalogue number	Packing (pcs)
	Diameter	Height	Diameter 1			
GL 202E	226	110	210	white	9299202E/W	12
GL 202E	226	110	210	satın nickel	9299202E/SN	12



GL 202



Model	Size (mm)			Colour body	Catalogue number	Packing (pcs)
	Diameter	Height	Diameter 1			
GL 202	226	110	210	white	9299202P/W	12
GL 202	226	110	210	satın nickel	9299202P/SN	12



Body: steel | **Diffuser:** transparent glass | **Ring:** aluminium alloy |
Reflector: aluminium mirror

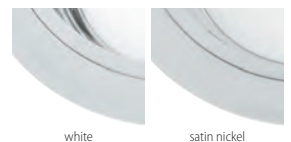

INTERIOR LIGHTING

Downlight fixtures for CFL

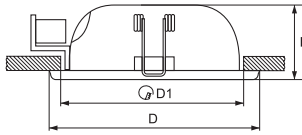

Legend:
D - Outer diameter
H - Height of the spotlight
D1 - Diameter of the cut

GL 203E



Model	Size (mm)			Colour body	Catalogue number	Packing (pcs)
	Diameter	Height	Diameter 1			
GL 203E	235	110	210	white	9299203E/W	12
GL 203E	235	110	210	satın nickel	9299203E/SN	12



GL 203



Model	Size (mm)			Colour body	Catalogue number	Packing (pcs)
	Diameter	Height	Diameter 1			
GL 203	235	110	210	white	9299203P/W	12
GL 203	235	110	210	satın nickel	9299203P/SN	12



Body: steel | **Diffuser:** matt glass | **Ring:** aluminium alloy |
Reflector: aluminium mirror



white satın nickel

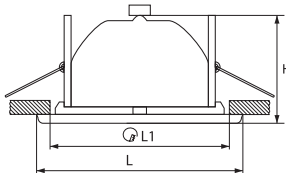

Legend:
L=Outer length
H=Height of the downlight
L1=W1- Length of the cut

GL 211E



Model	Size (mm)			Colour body	Catalogue number	Packing (pcs)
	Length/Width	Height	Length1/Width1			
GL 211E	230	110	210	white	9299211E/W	12
GL 211E	230	110	210	satın nickel	9299211E/SN	12

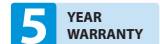

GL 211



Model	Size (mm)			Colour body	Catalogue number	Packing (pcs)
	Length/Width	Height	Length1/Width1			
GL 211	230	110	210	white	9299211P/W	12
GL 211	230	110	210	satın nickel	9299211P/SN	12



Body: steel | **Diffuser:** matt glass | **Ring:** aluminium alloy |
Reflector: aluminium mirror



white satın nickel

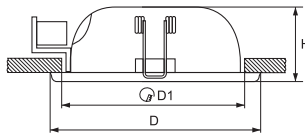

Legend:
D - Outer diameter
H - Height of the spotlight
D1 - Diameter of the cut

GL 205E



Model	Size (mm)			Colour body	Catalogue number	Packing (pcs)
	Diameter	Height	Diameter 1			
GL 205E	225	110	210	white	9299205E/W	12
GL 205E	225	110	210	satın nickel	9299205E/SN	12



GL 205



Model	Size (mm)			Colour body	Catalogue number	Packing (pcs)
	Diameter	Height	Diameter 1			
GL 205	225	110	210	white	9299205P/W	12
GL 205	225	110	210	satın nickel	9299205P/SN	12



Body: steel | **Diffuser:** glass with matt round | **Ring:** aluminium alloy | **Reflector:** aluminium mirror



white satın nickel

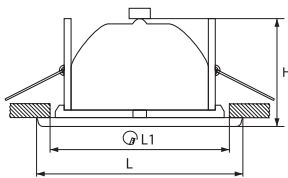
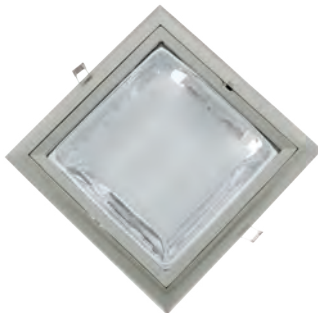

Legend:
L - W - Outer length
H - Height of the downlight
L1 - W1 - Length of the cut

GL 204E



Model	Size (mm)			Colour body	Catalogue number	Packing (pcs)
	Length/Width	Height	Length1/Width1			
GL 204E	230	110	210	white	9299204E/W	12
GL 204E	230	110	210	satın nickel	9299204E/SN	12



GL 204



Model	Size (mm)			Colour body	Catalogue number	Packing (pcs)
	Length/Width	Height	Length1/Width1			
GL 204	230	110	210	white	9299204P/W	12
GL 204	230	110	210	satın nickel	9299204P/SN	12



Body: steel | **Diffuser:** glass with matt square | **Ring:** aluminium alloy | **Reflector:** aluminium mirror

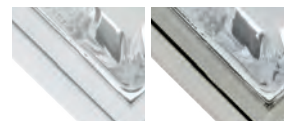

white satın nickel

INTERIOR LIGHTING

Downlight fixtures for CFL

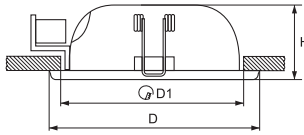

Legend:
D - Outer diameter
H - Height of the spotlight
D1 - Diameter of the cut

GL 206E

A++ C IP 20 RoHS COMPLIANT F/CE

Model	Size (mm)			Colour body	Catalogue number	Packing (pcs)
	Diameter	Height	Diameter 1			
GL 206E	225	110	210	satin nickel / chrome	9299206E/SH	12
GL 206E	225	110	210	graphite / chrome	9299206E/GH	12



5 YEAR WARRANTY

GL 206

A++ C IP 20 RoHS COMPLIANT F/CE

Model	Size (mm)			Colour body	Catalogue number	Packing (pcs)
	Diameter	Height	Diameter 1			
GL 206	225	110	210	satin nickel / chrome	9299206P/SH	12
GL 206	225	110	210	graphite / chrome	9299206P/GH	12



5 YEAR WARRANTY

Body: steel | **Diffuser:** glass with matt round | **Ring:** aluminium | **Reflector:** aluminium mirror

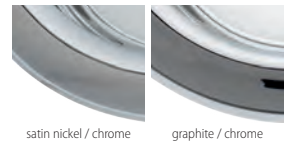

satin nickel / chrome graphite / chrome

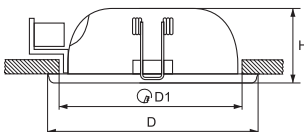

Legend:
D - Outer diameter
H - Height of the spotlight
D1 - Diameter of the cut

GL 210E

A++ C IP 20 RoHS COMPLIANT F/CE

Model	Size (mm)			Colour body	Catalogue number	Packing (pcs)
	Diameter	Height	Diameter 1			
GL 210E	228	110	210	white	9299210E/W	12
GL 210E	228	110	210	satin nickel	9299210E/SN	12



5 YEAR WARRANTY

GL 210

A++ C IP 20 RoHS COMPLIANT F/CE

Model	Size (mm)			Colour body	Catalogue number	Packing (pcs)
	Diameter	Height	Diameter 1			
GL 210	228	110	210	white	9299210P/W	12
GL 210	228	110	210	satin nickel	9299210P/SN	12



5 YEAR WARRANTY

Body: steel | **Diffuser:** glass with matt dots | **Ring:** aluminium | **Reflector:** aluminium mirror



white satin nickel

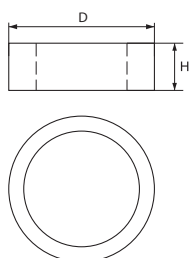

GL 213E



Model	Size (mm)		Colour body	Catalogue number	Packing (pcs)
	Diameter	Height			
GL 213E	266	65	white	9299213E/W	10
GL 213E	266	65	satin nickel	9299213E/SN	10



GL 213



Model	Size (mm)		Colour body	Catalogue number	Packing (pcs)
	Diameter	Height			
GL 213	266	65	white	9299213P/W	10
GL 213	266	65	satin nickel	9299213P/SN	10



Body: steel | **Diffuser:** glass with matt dots | **Reflector:** aluminium mirror



GL 214E



Model	Size (mm)		Colour body	Catalogue number	Packing (pcs)
	Length	Height			
GL214E	240	60	white	9299214E/W	10
GL 214E	240	60	satin nickel	9299214E/SN	10



Body: steel | **Diffuser:** glass with matt round | **Ring:** aluminium | **Reflector:** aluminium mirror

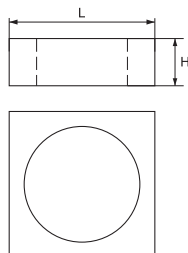

INTERIOR LIGHTING

Downlight fixtures for MHL

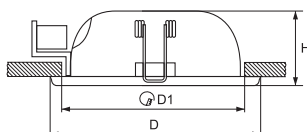

Legend:
D - Outer diameter
H - Height of the spotlight
D1 - Diameter of the cut

GL 208



Model	Size (mm)			Colour body	Catalogue number	Packing (pcs)
	Diameter	Height	Diameter 1			
GL 208	225	110	210	white	9299208M/W	12
GL208	225	110	210	satin nickel	9299208M/SN	12



Body: steel | **Diffuser:** glass with matt dots | **Ring:** aluminium | **Reflector:** aluminium

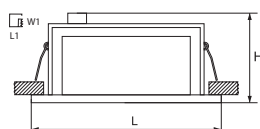

GL 212



Model	Size (mm)			Colour body	Catalogue number	Packing (pcs)
	L/L1	W/W1	H			
GL 212	230/215	150/125	123	white	9299212M/W	20
GL 212	230/215	150/125	123	satin nickel	9299212M/SN	20



Body: steel | **Diffuser:** transparent glass | **Ring:** aluminium | **Reflector:** aluminium

