



BKRS walkable cable tray systems



Building Connections

OBO
BETTERMANN

Reliable power and data supply for industry

Automated production lines and construction system applications consume very large quantities of energy and data, and hence require numerous cables. OBO walkable cable tray systems provide the ideal protection for these cables. The systems are tested according to EN 61537 and have tested load capacities according to EN 50085-2-2, and guarantee extremely high load capacities and safety in industrial environments.

OBO
BETTERMANN





System sizes

The BKRS cable tray is available with the side heights of 100 mm and 110 mm. The dimensions and materials mean that they satisfy the guidelines and requirements of numerous industries. With six widths between 100 mm and 600 mm available, there is a suitable cable tray system for every possible application.



Rugged connections

Heavy loads, stamping feet, dirt, dust – OBO's enclosed, walkable cable tray systems can handle all this and more, thanks to their ingenious system design. With their excellent mechanical stability, they offer effective protection for cables and lines. They all provide optimal shielding to ensure electromagnetic compatibility.



Tested anti-slip properties

The covers for the walkable cable trays are tested using the walking method – sloping level – according to EN 51130 and fulfil the requirements of BGR/GUV-R181. The occupational insurance rules for safety and health in the workplace (BGR/GUV for short) define the risk of slipping of flooring in working rooms and working areas. The non-slip covers ensure stability and thus minimise the risk of accidents in daily use.



Absolutely reliable

OBO's walkable cable tray systems offer users safe access to machines and systems. All the system components can accept large loads on account of their construction.

Barrier strips

The Z-shaped barrier strips are also 2 mm thick. For tray widths of up to 400 mm, one barrier strip is sufficient, while for widths up to 600 mm, two barrier strips should be used. A maximum size of 220 mm must therefore not be exceeded.



2
mm



Additional mounting space

The support bracket allows the mounting of clamp clips, enabling additional media to be routed under the cable trays.

Material stability

The base of the walkable cable tray system has a material strength of 2 mm. In combination with the other system components, the whole system is stable and load-bearing.



Accident prevention

An optional protection plate prevents dirt deposits from accumulating beneath the trays and also helps to prevent accidents.

Absolutely optimised

The walkable cable tray system from OBO has just got bigger. A new, one-part cover now allows optimum anti-slip properties. The cover, made from 2 mm-thick sheet steel, can now be mounted as required. The selection comprises turn buckles and cover clamps.

High traffic load

The basic material of the cover is 2 mm-thick strip galvanised sheet steel. The 1.3 mm-high chequer plate embossing means that the cover has a total thickness of 3.3 mm.



Tested load capacity

The strip-galvanised chequer plate cover is tested according to all the relevant standards and guarantees – depending on the installation type and subject to compliance with the mounting specifications – a footfall load of at least 350 kg according to EN 50085-2-2.

Anti-slip properties through optimised chequer arrangement

The newly developed chequer arrangement ensures optimum anti-slip properties, even in industrial areas, and is thus, according to BGR/GUV-R 181, suitable for most walkable environments with the risk of slipping. The anti-slip class is **R11** and the class of the wiring compartment is **V10**.



Cover clamp

The new cover clamps allow simple and flexible installation of the chequer plate cover on the walkable cable trays.

Perfect protection

All kinds of conditions are encountered in modern industrial plants. Often the environment is harsh, with dirt, vibrations and other side effects of industrial processes posing a serious risk to sensitive power, data and control cables. BKRS provides a safe, enclosed installation space for cables.

EMC-tested

Through the use of a barrier strip, power, control and data cables are insulated according to DIN EN 50174, to ensure electromagnetic compatibility. The trays and covers themselves provide perfect all-round protection for the cables.



Equipotential bonding

Flexible installation of equipotential bonding rails and earthing terminals for optimal implementation of EMC concepts – the OBO way.





Anti-slip strip

A self-adhesive, anti-slip strip secures the cover during mounting.



Dust protection

The dust protection elements on cover joints prevent the ingress of foreign bodies.

Mounting variants: Assembly options to meet every requirement

Refer to the mounting instructions for the walkable cable tray system.

Mounting options of the chequer plate cover

- Simple and rapid cover mounting with the new cover clamp
- Alternative mounting with turn buckle on break-out openings that can be chosen flexibly



Mounting on support bracket



- Fulfilment of workplace protection guidelines to avoid the risk of slipping or tripping
- Maintains standard step height
- Optional support element for tray widths of 400 mm or more

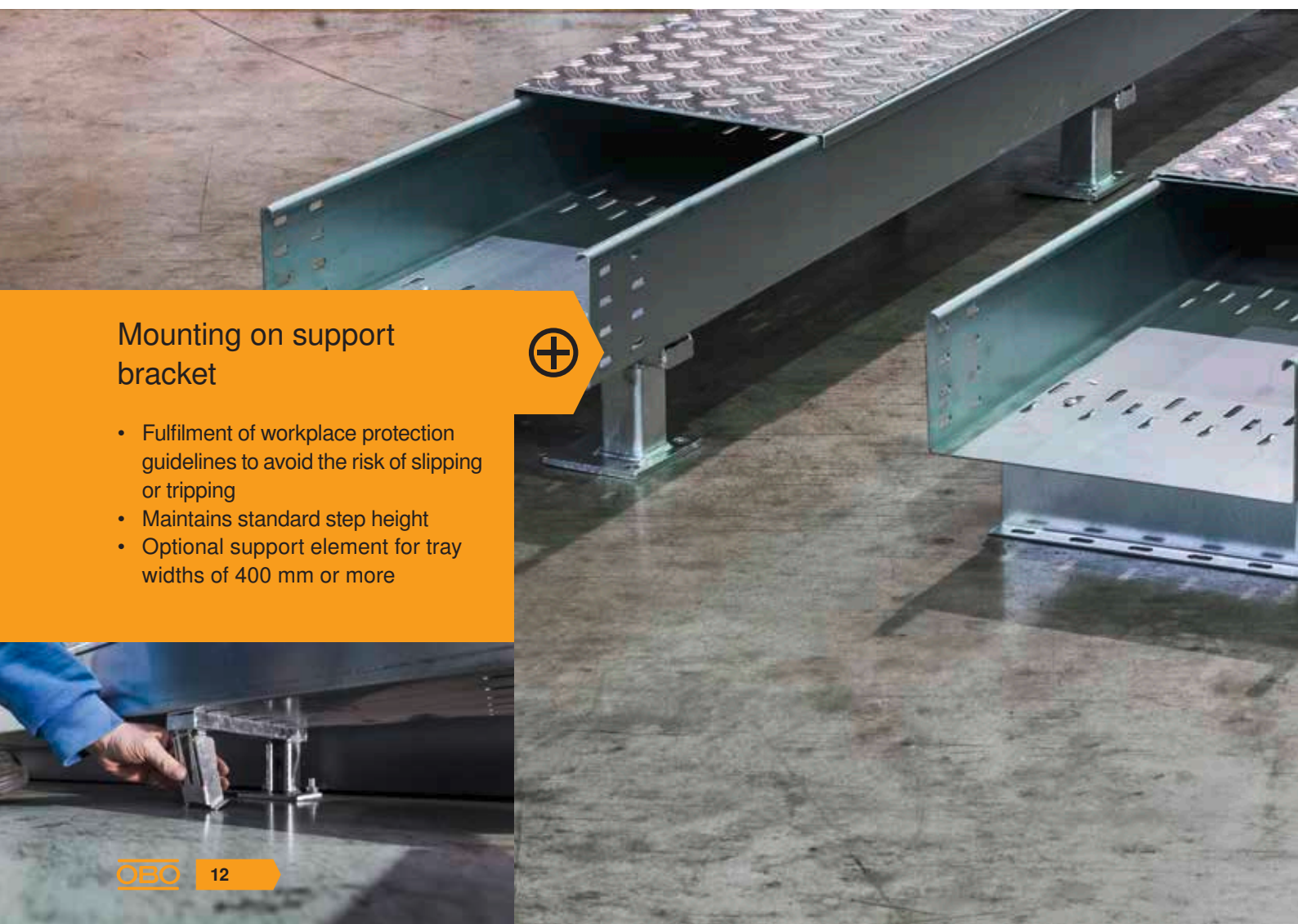



Mounting on Z-shaped support profile

- Maintains standard step height

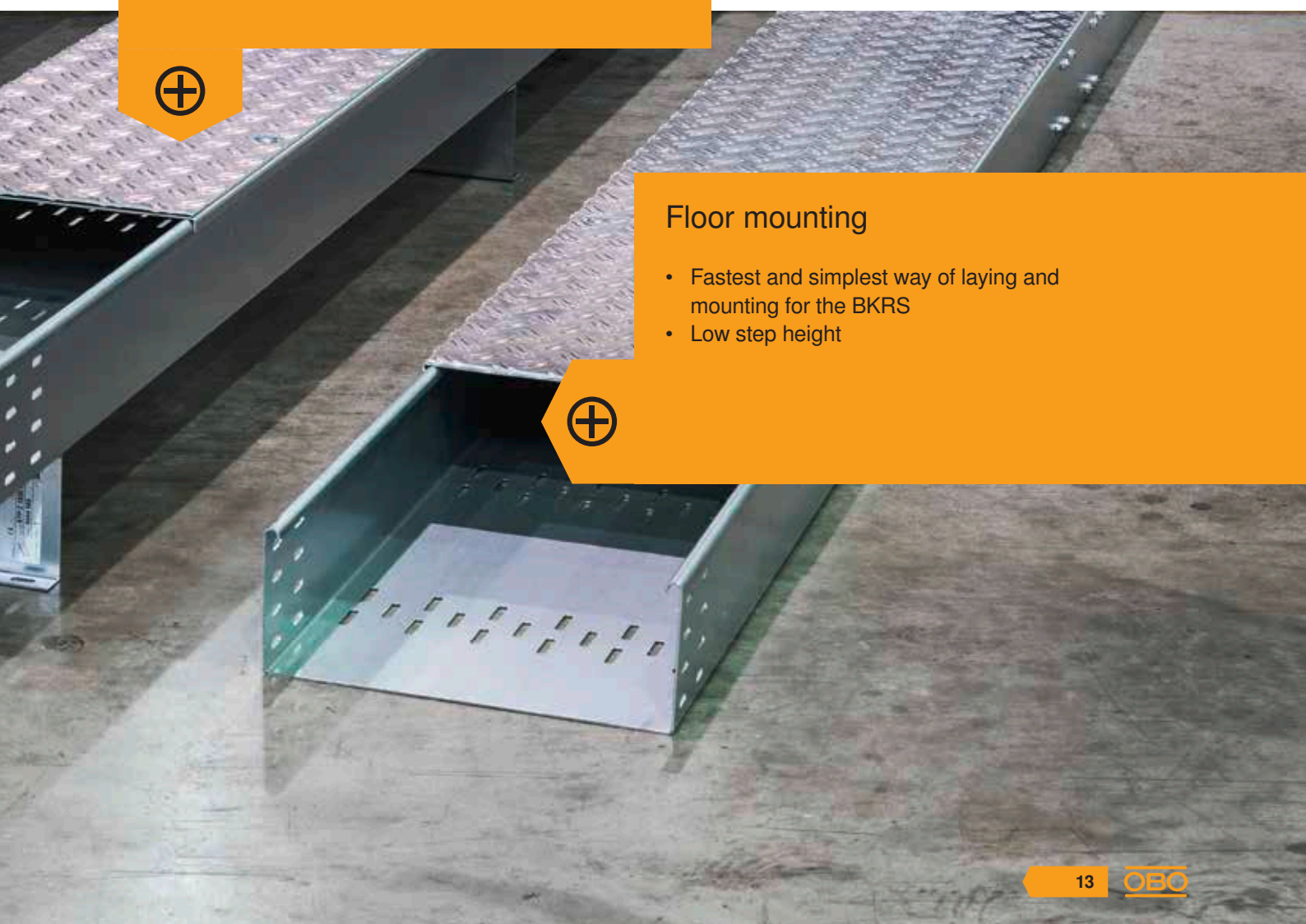

Floor mounting

- Fastest and simplest way of laying and mounting for the BKRS
- Low step height



The walkable cable tray system at a glance

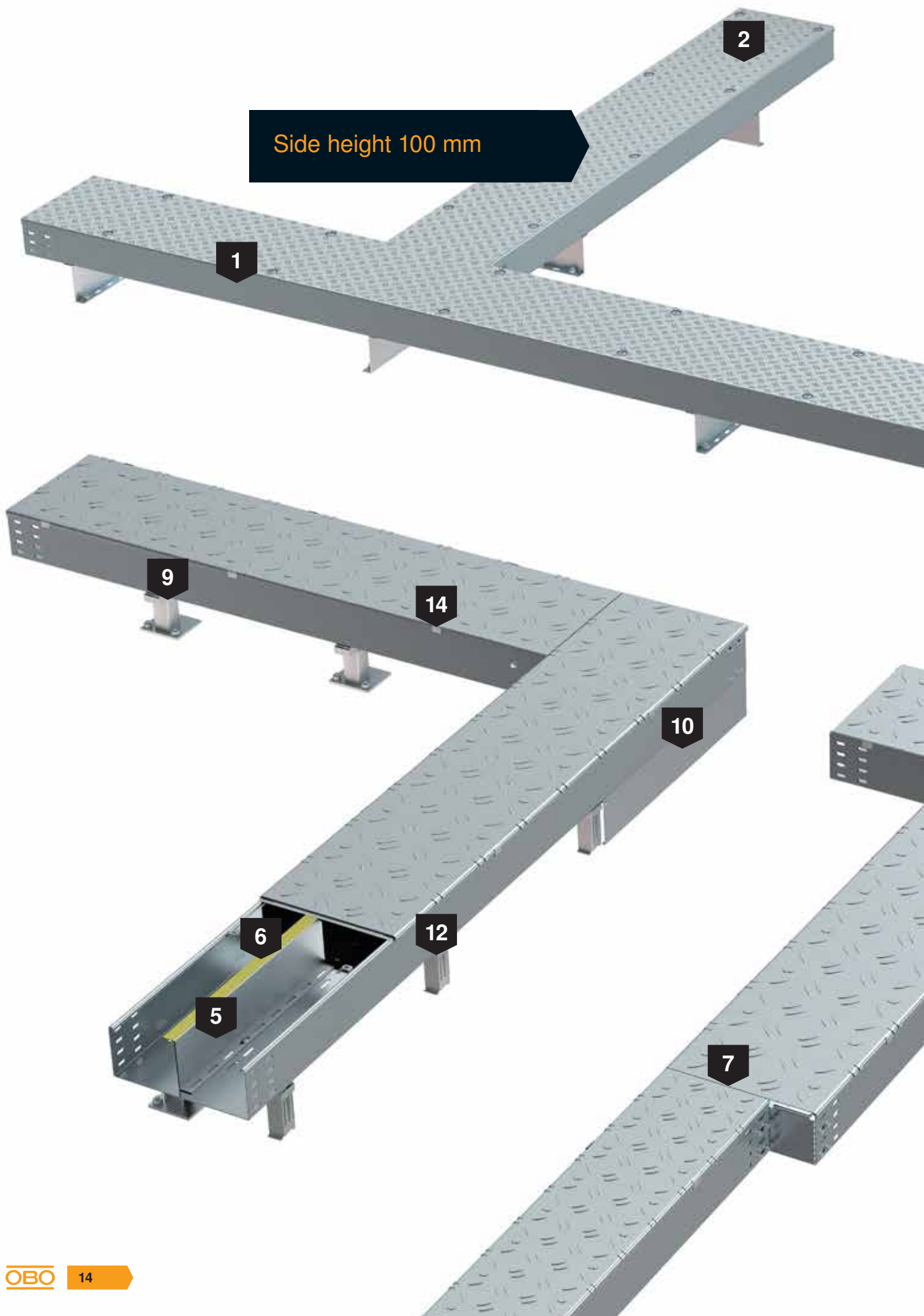

- 1 BKRS cable tray
- 2 Cover with chequer plate and turn buckle
- 3 Dust protection element
- 4 Cover support
- 5 Z-shaped barrier strip
- 6 Anti-slip strip
- 7 Reducing bracket
- 8 Support profile
- 9 Support bracket
- 10 Protective panel
- 11 Equipotential bonding rail
- 12 Support element
- 13 Chequer plate cover
- 14 Cover clamp

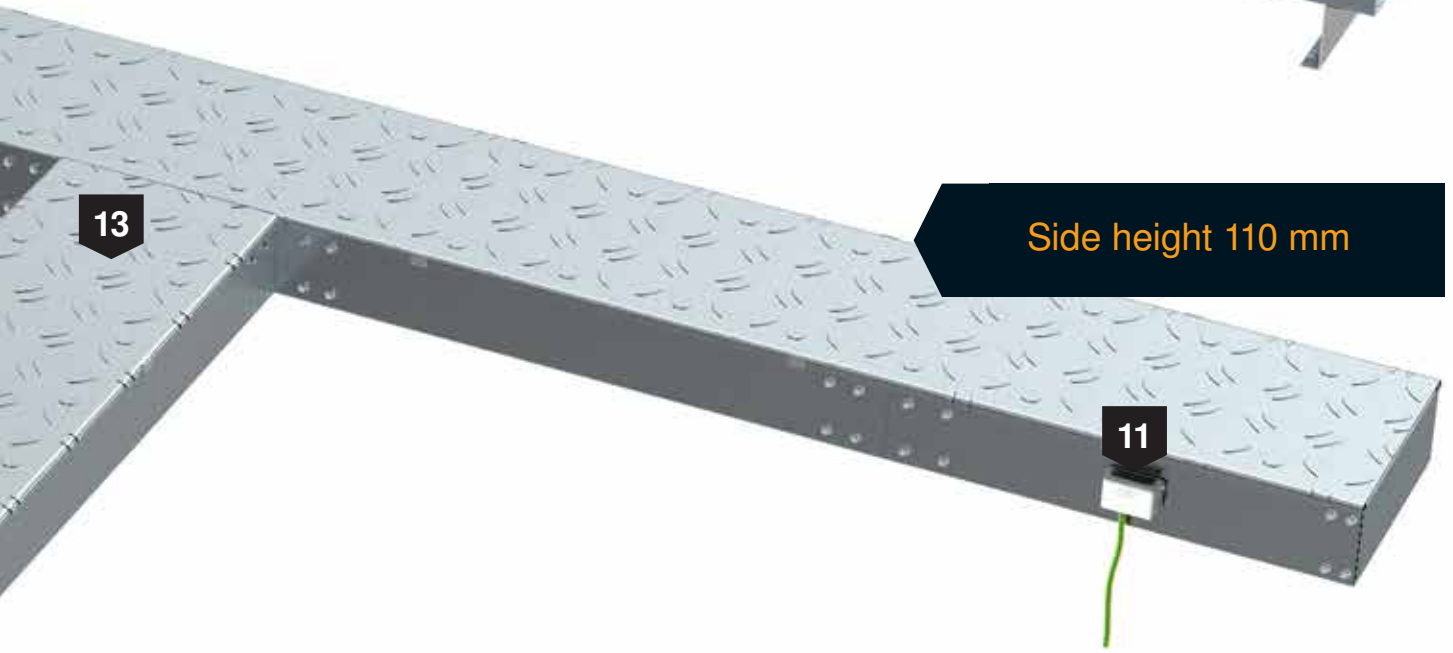
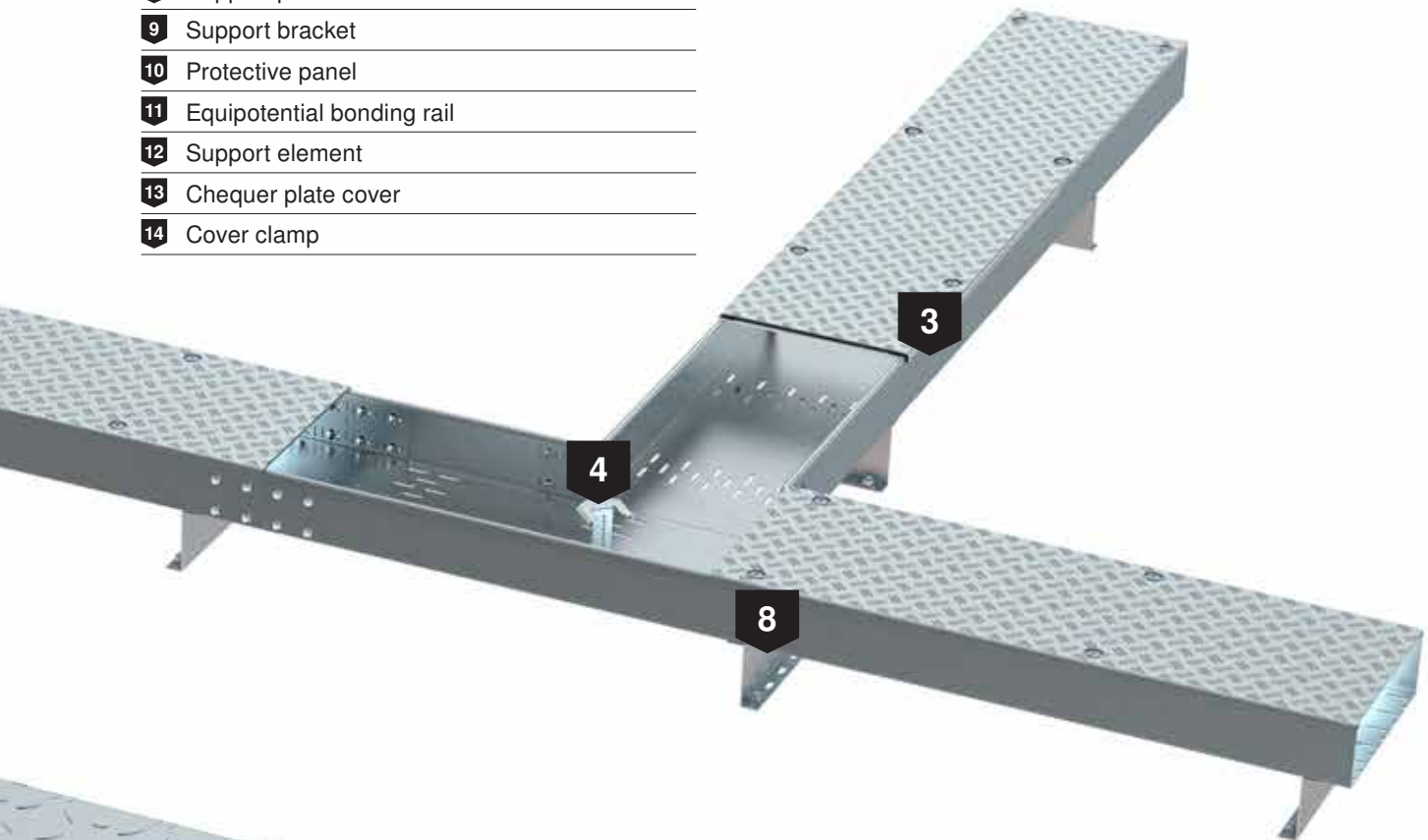

BET Test Centre

In our in-house BET Test Centre, OBO simulates the loads that the walkable cable tray systems have to withstand on a constant basis. We determine the maximum load capacity and carrying capacity of the system, as well as its resistance to dust and corrosion. In other words, OBO places paramount importance on safety.

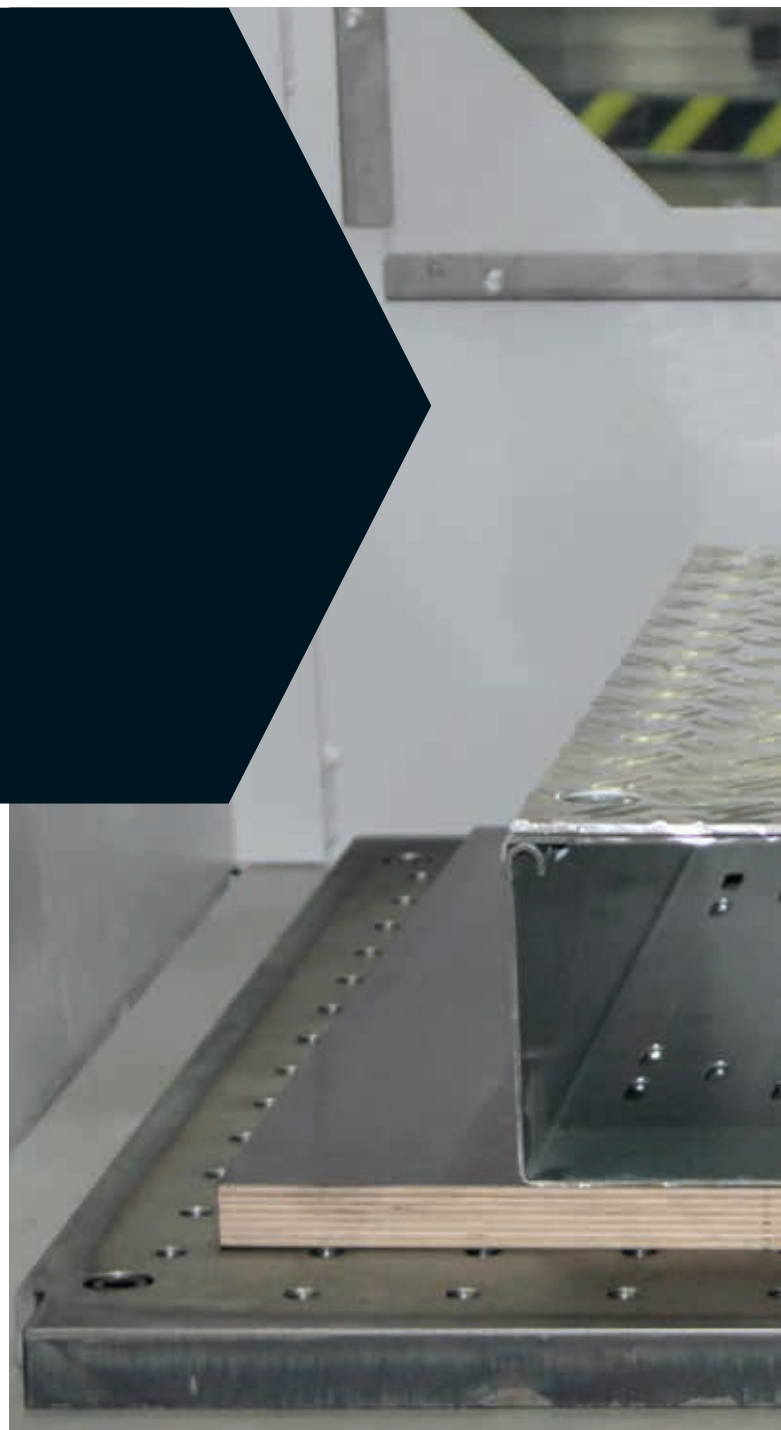

Standards

The BKRS walkable cable tray system from OBO conforms to the following standards:

- IEC 61537 – Cable management systems
- Load testing according to DIN EN 50085-2-2 – Electrical installation duct systems for electrical installations
- DIN EN 50174 – Information technology – Cabling installation (EMC)
- Testing of floor coverings – Determination of the anti-slip property according to DIN 51130 – Workrooms and fields of activities with slip danger (Walking method – Ramp test)

Through continuous controls and adherence to these standards, we ensure consistent quality and a high level of safety. OBO Bettermann plays an active part in the development of new standards and guidelines and our employees participate in national and international DKE, VDE, CENELEC and IEC standardisation committees.



Standards of the car manufacturers

The BKRS walkable cable tray system complies with the in-house standards of a wide range of car manufacturers. For each product, OBO provides comprehensive documentation, including all data sheets and load capacity test reports. We also supply all necessary evidence confirming adherence to the automakers' safety specifications.



Cable tray BKRS, side height 100



Type	Width mm	Plate thickness mm	Pack. m	Weight kg/100 m	Item No.
BKRS 1010 FS	100	2.00	3	485.670	6062000
BKRS 1020 FS	200	2.00	3	636.070	6062002
BKRS 1030 FS	300	2.00	3	789.040	6062004
BKRS 1040 FS	400	2.00	3	936.670	6062006
BKRS 1050 FS	500	2.00	3	1,086.970	6062008
BKRS 1060 FS	600	2.00	3	1,237.270	6062010

St Steel

FS Strip-galvanised

The cable tray has connector perforations on both sides.

Straight connectors should be ordered separately and in the appropriate quantity.

Heavy-duty, walkable cable tray system BKRS with base perforation, in 100 mm side height.

Dimensions

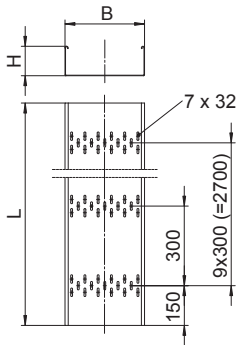

Type	Dimen- sion L mm	Dimen- sion B mm	Dimen- sion H mm	Plate thickness mm	Useful cross- section cm ²
BKRS 1010 FS	3000	100	100	2.00	84
BKRS 1020 FS	3000	200	100	2.00	171
BKRS 1030 FS	3000	300	100	2.00	258
BKRS 1040 FS	3000	400	100	2.00	345
BKRS 1050 FS	3000	500	100	2.00	432
BKRS 1060 FS	3000	600	100	2.00	519

Straight and angle connector

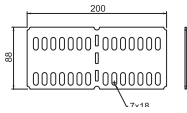
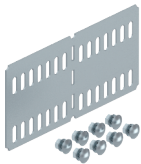

Type	Side height mm	Pack. pcs	Weight kg/100 pcs	Item No.
RLVL 100 FS	100	10	23.200	6067870

St Steel

FS Strip-galvanised

Including appropriate fastening material.

Straight and angle connector for cable trays and fittings with a side height of 100 mm.

Barrier strip, Z form, side height 100

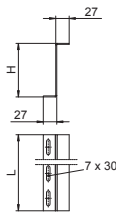
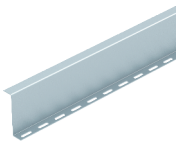

Type	Dimen- sion H mm	Plate thickness mm	Dimen- sion L mm	Pack. m	Weight kg/100 m	Item No.
TSG100Z BKRS FS	100	2.00	3000	3	218.670	6062390

St Steel

FS Strip-galvanised

Barrier strip for the BKRS walkable cable tray system. Attachment with truss-head bolts M 6 x 12 in the base perforation.

Truss-head bolt with flange nut

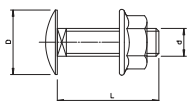
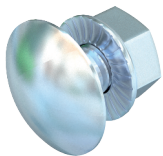

Type	Dimension mm	Dimen- sion L mm	Dimen- sion D mm	Dimen- sion d mm	Pack. pcs	Weight kg/100 pcs	Item No.
FRSB 6x12 G	M 6 x 12	12	13.5	6	100	0.796	6406130

St Steel

G Electrogalvanised

For universal fastening of construction components. Permitted use of the article only in dry atmospheres.

Hot galvanised truss-head bolt with square neck including electrogalvanised combination nut.

Anti-slip strip

Type	Pack. Weight		Item No.
	m	kg/100 m	
ARS BKR	36	10.070	6049259

GUM Rubber

Self-adhesive, anti-slip strip to stick onto the Z-shaped barrier in walkable cable trays, for securing laid-on but not yet attached covers.



Reducing bracket/end closure

Type	Side height mm	Dimension B mm	Pack. Weight		Item No.
			pcs	kg/100 pcs.	
RWEB 1010 FS	100	100	1	13.600	7111802
RWEB 1020 FS	100	200	1	22.100	7111804
RWEB 1030 FS	100	300	1	30.600	7111806
RWEB 1040 FS	100	400	1	39.100	7111808
RWEB 1050 FS	100	500	1	47.600	7111810
RWEB 1060 FS	100	600	1	56.100	7111812

St Steel

FS Strip-galvanised

Including appropriate fastening material.

Reducer/stop-end for cable trays with side height 100 mm.

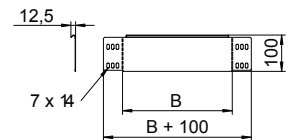
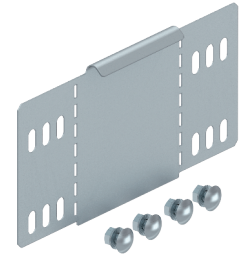

Cable tray BKRS, side height 110

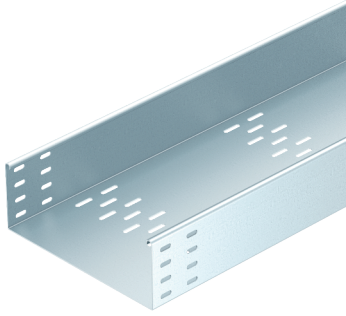

Type	Width mm	Plate thickness mm	Pack. m	Weight kg/100 m	Item No.
BKRS 1110 FS	100	2.00	3	526.000	6061981
BKRS 1120 FS	200	2.00	3	676.340	6061983
BKRS 1130 FS	300	2.00	3	826.670	6061985
BKRS 1140 FS	400	2.00	3	977.000	6061987
BKRS 1150 FS	500	2.00	3	1,127.340	6061989
BKRS 1160 FS	600	2.00	3	1,277.340	6061991

St Steel

FS Strip-galvanised

The cable tray has connector perforations on both sides.

Straight connectors should be ordered separately and in the appropriate quantity.

Heavy-duty, walkable cable tray system BKRS with base perforation, in 110 mm side height.

Dimensions

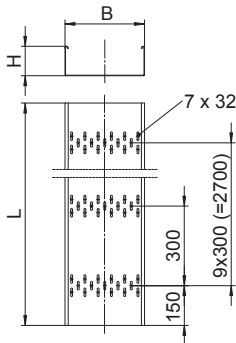

Type	Dimen- sion L mm	Dimen- sion B mm	Dimen- sion H mm	Plate thickness mm	Useful cross- section cm ²
BKRS 1110 FS	3000	100	110	2.00	96
BKRS 1120 FS	3000	200	110	2.00	196
BKRS 1130 FS	3000	300	110	2.00	296
BKRS 1140 FS	3000	400	110	2.00	396
BKRS 1150 FS	3000	500	110	2.00	496
BKRS 1160 FS	3000	600	110	2.00	596

Straight and angle connector

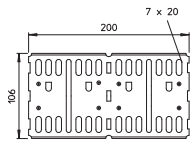
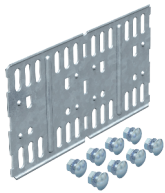

Type	Side height mm	Pack. pcs	Weight kg/100 pcs.	Item No.
RLVL 110 FS	110	10	33.800	6067131

St Steel

FS Strip-galvanised

Including appropriate fastening material.

Straight and angle connector for cable trays and fittings with a side height of 110 mm.

Barrier strip, Z form, side height 110

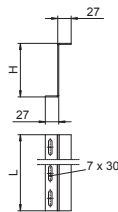
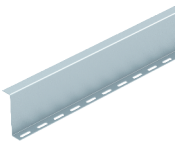

Type	Dimen- sion H mm	Plate thickness mm	Dimen- sion L mm	Pack. m	Weight kg/100 m	Item No.
TSG110Z BKRS FS	110	2.00	3000	3	240.670	6062391

St Steel

FS Strip-galvanised

Barrier strip for the BKRS walkable cable tray system. Attachment with truss-head bolts M 6 x 12 in the base perforation.

Truss-head bolt with flange nut

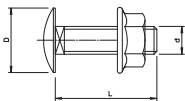
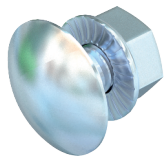

Type	Dimension mm	Dimen- sion L mm	Dimen- sion D mm	Dimen- sion d mm	Pack. pcs	Weight kg/100 pcs.	Item No.
FRSB 6x12 G	M 6 x 12	12	13.5	6	100	0.796	6406130

St Steel

G Electrogalvanised

For universal fastening of construction components. Permitted use of the article only in dry atmospheres.

Hot galvanised truss-head bolt with square neck including electrogalvanised combination nut.

Anti-slip strip

Type	Pack. Weight		Item No.
	m	kg/100 m	
ARS BKR	36	10.070	6049259

GUM Rubber

Self-adhesive, anti-slip strip to stick onto the Z-shaped barrier in walkable cable trays, for securing laid-on but not yet attached covers.



Reducing bracket/end closure

Type	Side height mm	Dimension B mm	Pack. Weight		Item No.
			pcs	kg/100 pcs.	
RWEB 110 FS	110	100	1	16.400	7111096
RWEB 120 FS	110	200	1	29.000	7111207
RWEB 130 FS	110	300	1	40.700	7111304
RWEB 140 FS	110	400	1	52.900	7111428
RWEB 150 FS	110	500	1	64.800	7111509
RWEB 160 FS	110	600	1	71.000	7111740

St Steel

FS Strip-galvanised

From a width of 150 mm, the perforated lower flange is provided. Including appropriate fastening material.

Reducer/stop-end for cable trays with side height 110 mm.

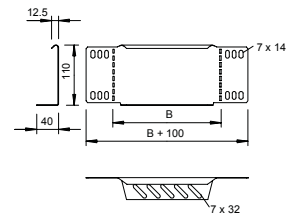
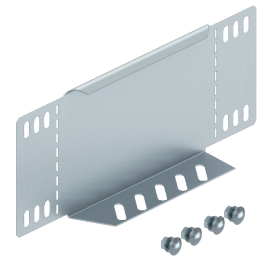

Chequer plate lid, non-slip R11 according to DIN 51130

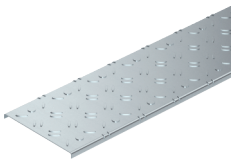

Type	Dimension B mm	Dimension b mm	Dimension L mm	Plate thickness mm	Pack. m	Weight kg/100 m	Item No.
DBKR 100 FS	100	100	3000	3.30	3	195.070	6049119
DBKR 200 FS	200	50	3000	3.30	3	352.070	6049121
DBKR 300 FS	300	100	3000	3.30	3	509.070	6049123
DBKR 400 FS	400	50	3000	3.30	3	666.070	6049125
DBKR 500 FS	500	100	3000	3.30	3	823.070	6049127
DBKR 600 FS	600	50	3000	3.30	3	980.070	6049129

St Steel

FS Strip-galvanised

When using covers outdoors, additional measures against the influence of wind must be taken.

The lids are tested according to DIN51130 and possess anti-slip class R11 and displacement space class V10.

Lid fastenings are not part of the scope of delivery and can be ordered separately.

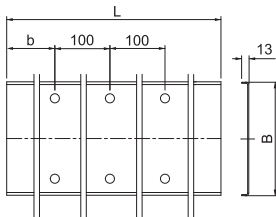

Lid clamp DK BKR

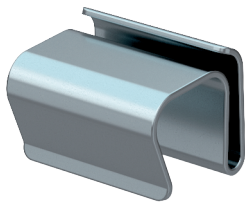

Type	Pack. pcs	Weight kg/100 pcs.	Item No.
DK DBKR G	30	0.794	6049280

St Steel

G Electrogalvanised

Cover clamp for secure fastening of covers on cable trays and cable ladders.

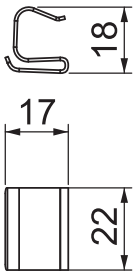

Turn buckle



Type	Pack. pcs	Weight kg/100 pcs.	Item No.
DRL H FT	20	2.187	6065012

St Steel

FT Hot-dip galvanised

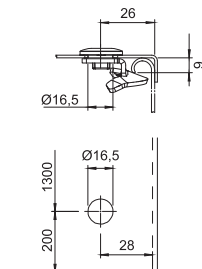

Cover with chequer plate, turn buckle spacing 500 mm

Type	Dimen- sion B mm	Dimen- sion L mm	Plate thickness mm	Pack. m	Weight kg/100 m	Item No.
DF BKR10 FS AL	100	3000	6.00	3	272.330	6049181
DF BKR20 FS AL	200	3000	6.00	3	503.670	6049183
DF BKR30 FS AL	300	3000	6.00	3	735.000	6049185
DF BKR40 FS AL	400	3000	6.00	3	966.670	6049187
DF BKR50 FS AL	500	3000	6.00	3	1,197.670	6049189
DF BKR60 FS AL	600	3000	6.00	3	1,429.000	6049191

Alu/St Aluminium/Steel

Cable tray cover for the walkable BKRS cable tray system. The basic cover is strip galvanised in a material thickness of 2 mm with additional aluminium chequer riveted on in a thickness of 4 mm, sturdy and non-slip. Turn buckle fastening with a turn buckle distance of 500 mm.

When using covers outdoors, additional measures against the influence of wind must be taken.

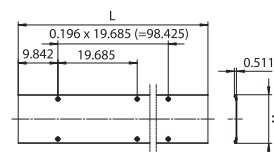
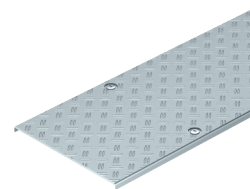

Cover with chequer plate, turn buckle spacing 1,000 mm

Type	Dimen- sion B mm	Dimen- sion L mm	Plate thickness mm	Pack. m	Weight kg/100 m	Item No.
DF BKR1010 4FSAL	100	3000	4.00	3	243.000	6049110
DF BKR2010 4FSAL	200	3000	4.00	3	442.340	6049111
DF BKR3010 4FSAL	300	3000	4.00	3	642.000	6049112
DF BKR4010 4FSAL	400	3000	4.00	3	841.340	6049113
DF BKR5010 4FSAL	500	3000	4.00	3	1,041.000	6049114
DF BKR6010 4FSAL	600	3000	4.00	3	1,240.340	6049115

Alu/St Aluminium/Steel

Cable tray cover for the walkable BKRS cable tray system. The basic cover is strip galvanised in a material thickness of 2 mm with additional aluminium chequer riveted on in a thickness of 2 mm, sturdy and non-slip. Turn buckle fastening with a turn buckle distance of 1,000 mm.

When using covers outdoors, additional measures against the influence of wind must be taken.

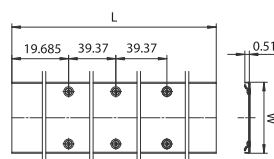
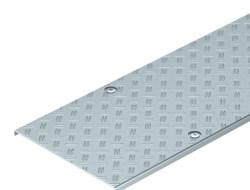

Cover with chequer plate, turn buckle spacing 1,000 mm

Type	Dimen- sion B mm	Dimen- sion L mm	Plate thickness mm	Pack. m	Weight kg/100 m	Item No.
DF BKR10 10 FSAL	100	3000	6.00	3	274.570	6049200
DF BKR20 10 FSAL	200	3000	6.00	3	505.900	6049202
DF BKR30 10 FSAL	300	3000	6.00	3	737.240	6049204
DF BKR40 10 FSAL	400	3000	6.00	3	968.570	6049206
DF BKR50 10 FSAL	500	3000	6.00	3	1,199.900	6049208
DF BKR60 10 FSAL	600	3000	6.00	3	1,431.240	6049210

Alu/St Aluminium/Steel

Cable tray cover for the walkable BKRS cable tray system. The basic cover is strip galvanised in a material thickness of 2 mm with additional aluminium chequer riveted on in a thickness of 4 mm, sturdy and non-slip. Turn buckle fastening with a turn buckle distance of 1,000 mm.

When using covers outdoors, additional measures against the influence of wind must be taken.

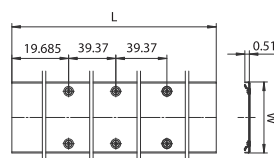
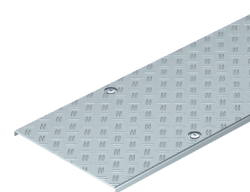

Dust protection element



Type	Dimension B mm	Pack.	Weight	Item No.
		pcs	kg/100 pcs.	
SSE SSLB 100 FS	100	1	1.574	6049290
SSE SSLB 200 FS	200	1	3.145	6049292
SSE SSLB 300 FS	300	1	4.716	6049294
SSE SSLB 400 FS	400	1	6.287	6049296
SSE SSLB 500 FS	500	1	7.858	6049298
SSE SSLB 600 FS	600	1	9.429	6049300

St Steel

FS Strip-galvanised

Cover support, side height 110

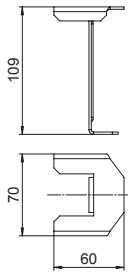

Type	Side height mm	Pack.	Weight	Item No.
		pcs	kg/100 pcs.	
DST110 BKRS FS	109	10	10.800	6049256

St Steel

FS Strip-galvanised

Cover support for the walkable BKRS cable tray system, for additional support of covers and fitting covers at a side height of 110 mm.

Support profile, side height 100

Type	Dimension L mm	Plate thickness mm	Pack. pcs	Weight		Item No.
				kg/100	pcs.	
STP Z 1010 FS	100	2.00	1	22.500		6044581
STP Z 1020 FS	200	2.00	1	44.800		6044583
STP Z 1030 FS	300	2.00	1	67.200		6044585
STP Z 1040 FS	400	2.00	1	89.500		6044587
STP Z 1050 FS	500	2.00	1	111.800		6044589
STP Z 1060 FS	600	2.00	1	134.200		6044591
STP Z 10300 FS	3000	2.00	3	223.400		6044596

Sl Steel

FS Strip-galvanised

Support profile for holding up the walkable cable tray system BKRS from the floor. Installation must be performed on both sides of the Z profile during the process of securing the system so that it is held up.

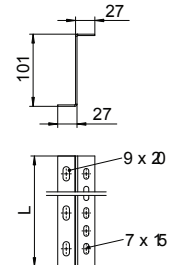
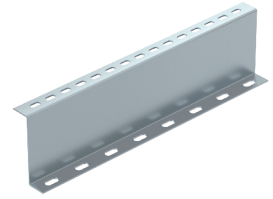

Support bracket

Type	Dimension B mm	Dimension b1 mm	Dimension b2 mm	Pack. pcs	Weight		Item No.
					kg/100	pcs.	
STA BKS10 FT	97	13	43	1	69.500		6044561
STA BKS20 FT	197	13	143	1	84.900		6044563
STA BKS30 FT	297	25	231	1	100.300		6044565
STA BKS40 FT	397	25	331	1	115.600		6044567
STA BKS50 FT	497	125	331	1	131.000		6044569
STA BKS60 FT	597	225	331	1	146.400		6044571

Sl Steel

FT Hot-dip galvanised

Support bracket for holding up the BKRS cable tray system from the floor.

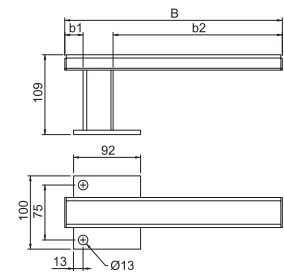

Support element BKS

Type	Pack. pcs	Weight		Item No.
		kg/100	pcs.	
STE BKS FS	10	13.000		6044554

Sl Steel

FS Strip-galvanised

Additional support for support bracket for holding up the BKRS cable tray system from the floor.

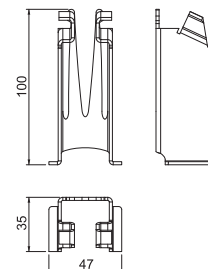

Edge protection strip

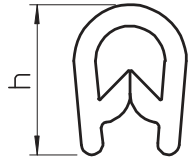

Type	For plate thickness		Dimension h	Pack. m	Weight kg/100 m	Item No.
	mm	mm				
KSB 4 PVC	1.5 - 4	15		10	14.000	6072895

PVC Polyvinylchloride

Edge protection strip with steel inlay to cover cut plate ends. Black, UV-resistant version.

Protective panel

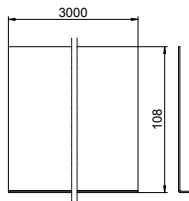

Type	Length mm	Height mm	Thickness mm	Pack. m	Weight kg/100 m	Item No.

St Steel
FS Strip-galvanised

Collision guard, to be attached at the side as a collision guard for the walkable BKRS cable tray system. The side height is 108 mm.

Drilling screw

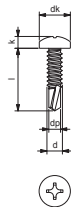

Type	Dimension mm	Pack. pcs	Weight kg/100 pcs.	Item No.

St Steel
G Electrogalvanised

Drilling screw according to DIN 7504.

Truss-head bolt

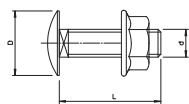
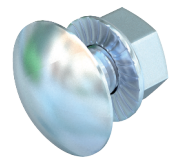

Type	Dimension mm	Dimension L mm	Dimension D mm	Dimension d mm	Pack. pcs	Weight kg/100 pcs.	Item No.

St Steel
G Electrogalvanised

For universal fastening of construction components. Permitted use of the article only in dry atmospheres.

Hot galvanised truss-head bolt with square neck including electrogalvanised combination nut.

Earthing terminal

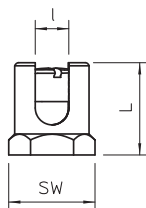
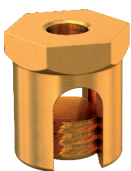

Type	Dimension L mm	Dimension l mm	Cross-section mm ²	Thread	Pack. pcs	Weight kg/100 pcs.	Item No.
EKL 35 M6	26	10	35	M6	50	4.800	6404014
EKL 25 M8	26	10	25	M8	50	3.970	6404001

CuZn Brass

Earthing terminal for fastening the equipotential bonding wire to the cable support system.

Equipotential bonding rail for small systems

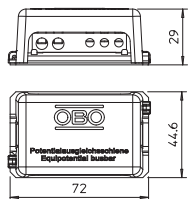

Type	Pack. pcs	Weight kg/100 pcs.	Item No.

CuZn Brass

- Cover made of polystyrene, grey
- Sealable / labellable cover
- Base plate made of strip galvanised steel
- Contact strip and screws made of nickel-plated brass

Connection options:

- 3 x multi-core cables to 6 mm²
- 2 x multi-core cables to 16 mm²

Nail anchor N-K with nail head

Type	Bore hole Ø mm	Bore hole depth mm	Clamping range mm	Dimension L mm	Dimension D mm	Pack. pcs	Weight kg/100 pcs.	Item No.
N-K 6-5-10/44	6	40	5 - 10	44	13	100	1.135	3498390

St Steel

G Electrogalvanised

European technical approval ETA-11/0240, including characteristic values under fire exposure to fire resistance R 120.

The nail anchor N-K can be used for multiple fastenings of non-load-bearing systems and in cracked and non-cracked concrete, thereby combining the benefits of a bolt tie with an even easier mounting. The nail anchor only needs to be hammered into the drill hole. When the load occurs, the nail anchor spreads itself and bolts itself in the drill hole.

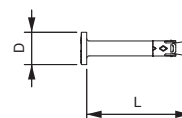

Nail anchor N with thread

Type	Thread	Bore hole Ø mm	Bore hole depth mm	Clamping range mm	Dimension L mm	Pack. pcs	Weight kg/100 pcs.	Item No.
N 6-5-10/49	M6	6	40	5 - 10	49	100	1.160	3498396

St Steel

G Electrogalvanised

European technical approval ETA-11/0240, including characteristic values under fire exposure to fire resistance R 120.

The nail anchor N can be used for multiple fastenings of non-load-bearing systems and in cracked and non-cracked concrete, thereby combining the benefits of a bolt tie with even easier mounting. The nail tie only needs to be hammered into the drill hole. It is not necessary to apply torque subsequently. When the load occurs, the nail tie spreads itself and bolts itself in the drill hole.

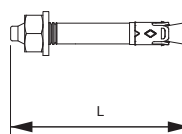

Wedge anchor BZ-U

Type	Thread	Dimension L mm	Pack. pcs	Weight kg/100 pcs.	Item No.
BZ-U 10-10-30/90	M10	90	50	6.720	3498334
BZ-U 10-30-50/110	M10	110	25	7.900	3498340

St Steel

G Electrogalvanised

Bolt tie BZ for the anchoring of medium-duty to heavy-duty loads, both in cracked and non-cracked concrete. It combines high approved loads with small edge distances and axial spacings. European technical approval ETA-99/0010, including characteristic values under fire exposure to fire resistance R 120.

Proof of suitability in the case of seismic impacts, categories C1 and C2.

Shock approval by the Federal Office for Civil Protection in Bern, Switzerland.

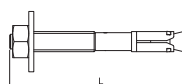

Wedge anchor BZ

Type	Thread	Dimension L mm	Pack. pcs	Weight kg/100 pcs.	Item No.
BZ10-100-120/180	M10	180	25	10.320	3498342
BZ 12-15-35/110	M12	110	25	10.320	3498350

St Steel

G Electrogalvanised

Wedge anchor BZ for the anchoring of medium-duty to heavy-duty loads, both in cracked and non-cracked concrete. It combines high approved loads with small edge distances and axial spacings.

European technical approval ETA-99/0010, including characteristic values under fire exposure to fire resistance R 120.

Proof of suitability in the case of seismic impacts, categories C1 and C2.

Shock approval by the Federal Office for Civil Protection in Bern, Switzerland.

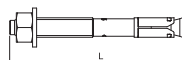

Wedge anchor BZ

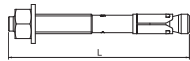

Type	Thread	Dimension L mm	Pack. pcs	Weight kg/100 pcs.	Item No.
BZ10-100-120/180	M10	180	25	10.320	3498342
BZ 10-150/230	M10	230	25	13.600	3498344
BZ 12-15-35/110	M12	110	25	10.320	3498350
BZ 12-85-105/180	M12	180	25	14.900	3498354
BZ12-105-125/200	M12	200	25	16.400	3498356
BZ 12-160/255	M12	255	20	22.400	3498358

- St** Steel
- G** Electrogalvanised

European technical approval ETA-99/0010, including characteristic values under fire exposure to fire resistance R 120.

Proof of suitability in the case of seismic impacts, categories C1 and C2.
Shock approval by the Federal Office for Civil Protection in Bern, Switzerland.

Wedge anchor BZ for the anchoring of medium-duty to heavy-duty loads, both in cracked and non-cracked concrete. It combines high approved loads with small edge distances and axial spacings.

Load

Standard anchoring depth

Loads and Characteristics	embedment depth mm	Bore hole Ø mm	Bore hole depth mm	Clamping strength mm	Approved load area, tension zone kN
M 8-100/165	46	8	60	100	2,4
M 10-75/155	60	10	75	75	4,3
M 10-100/180	60	10	75	100	4,3
M 10-150/230	60	10	75	150	4,3
M 12-15/110	70	12	90	15	7,6
M 12-85/180	70	12	90	85	7,6
M 12-105/200	70	12	90	105	7,6
M 12-160/255	70	12	90	160	7,6
M 16-15/135	85	16	110	15	11,9

Reduced anchoring depth

Loads and Characteristics	embedment depth mm	Bore hole Ø mm	Bore hole depth mm	Clamping strength mm	Approved load area, tension zone kN
M 8-111/165	35	8	49	111	2,4
M 10-95/155	40	10	55	95	3,6
M 10-120/180	40	10	55	120	3,6
M 12-35/110	50	12	70	35	6,1
M 12-105/180	50	12	70	105	6,1
M 12-125/200	50	12	70	125	6,1
M 16-35/135	65	16	90	35	9,0

MMS hex

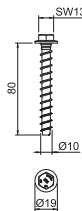

Type	Dimension mm	Dimension L mm	Bore hole Ø mm	Bore hole SW mm	Pack. pcs	Weight kg/100 pcs.	Item No.
MMS-plus 10x80	10 x 80	80	8	13	50	4.000	3498124

- St** Steel
- G** Electrogalvanised

Fire protection bolt tie with hexagonal head for direct mounting without additional anchor. WAF 13, drill hole 8 mm. Tested anchor according to ETAG 001 - Part 3. Fire resistance class to R120 for concrete and masonry.

MMS-MS pan head

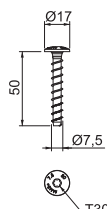

Type	Dimension mm	Anchor length mm	Bore hole Ø mm	Head Ø mm	Screw system	Pack. pcs	Weight kg/100 pcs.	Item No.
MMS-plus 7.5X50	7,5 x 50	50	6	17	Torx	100	1.500	3498261

- St** Steel
- G** Electrogalvanised

Fire protection bolt tie with large pan head for direct mounting without additional anchors. Drive T30, drill hole 6 mm. Tested anchor according to ETAG 001 - Part 3. Fire resistance class to R120 for concrete and masonry.



OBO Bettermann GmbH & Co. KG
PO Box 1120
58694 Menden
GERMANY

Customer Service Germany
Tel.: +49 (0)2371 7899-1700
Fax: +49 (0)2371 7899-1238
@obo.de

www.obo-bettermann.com

Building Connections

