

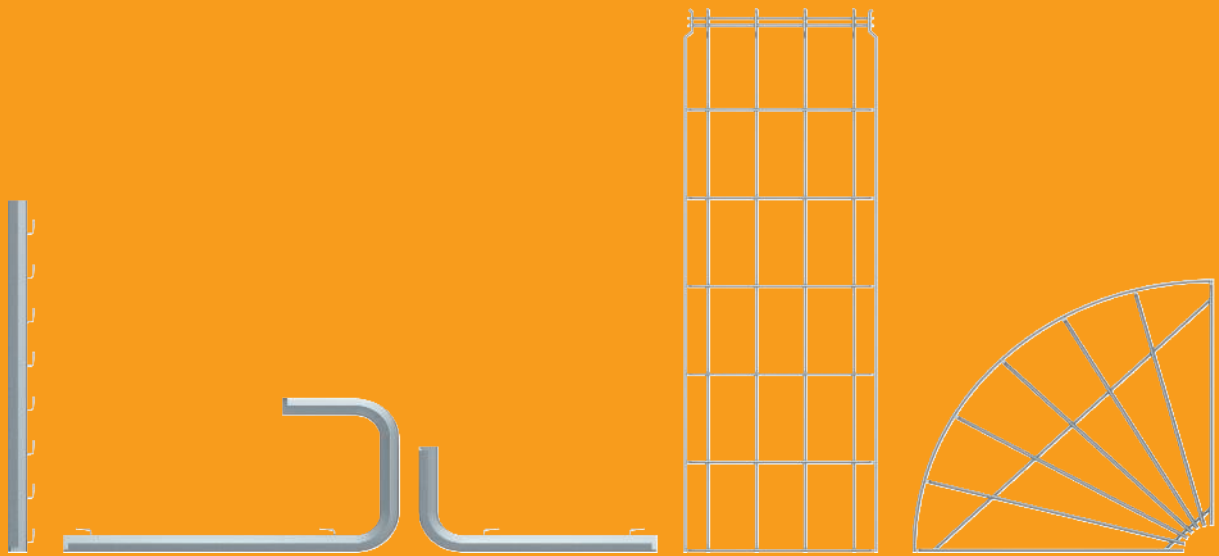

Mesh cable tray systems



Quick
Screwless
Safe
Stable



OBO Bettermann's mesh cable tray systems are the ideal basis for quick, safe and economical cable routing in all areas of professional electrical installations. The GR-Magic®, the Magic® G mesh cable tray, the C mesh cable tray and the heavy-duty SGR mesh cable tray with their various shapes, side heights, surfaces and range of accessories are ideal for satisfying the most varied cable routing requirements. The systems are well thought through and extremely efficient when in daily use.

Installation time is an important factor when it comes to choosing whether to buy a product or not. With the GR-Magic® mesh cable tray in both the standard design or as a G mesh cable tray, OBO Bettermann can offer a true system innovation. Thanks to the patented connection system developed by OBO, the mesh cable tray can be mounted in a matter of seconds – without any connectors or tools. Just connect the two parts and you're done. The system has therefore redefined the concepts of rapid mounting and flexibility.

OBO
BETTERMANN



Logical

The OBO mesh cable tray system

Magic® mesh cable tray



Side height mm	G Electro-galvanised	FT Hot-dip galvanised	A2 Stainless steel	A4 Stainless steel
35	✓	✓	✓	✓
55	✓	✓	✓	✓
105	✓	✓	✓	✓

G FT A2 A4

For fixing on brackets, suspension fittings and spacer clamps

Magic® G mesh cable tray



Side height mm	G Electro-galvanised	FT Hot-dip galvanised	A2 Stainless steel	A4 Stainless steel
50	✓	✓	✓	✓
75	✓	✓	✓	✓
125	✓	✓	✓	✓
150	✓	✓	✓	✓

G FT A2 A4

For direct wall or ceiling mounting

C mesh cable tray



Side height mm	FT Hot-dip galvanised	A2 Stainless steel
50	✓	✓

FT A2

For fixing on brackets, suspension fittings and spacer clamps

Heavy-duty mesh cable tray SGR



Side height mm	G Electro-galvanised	FT Hot-dip galvanised	A2 Stainless steel
55	✓	✓	✓
105		✓	✓
155	✓	✓	

G FT A2

For fastening on brackets and suspensions

* Further combinations of surfaces and systems on request



Magic® mesh cable tray



The new GR-Magic® mesh cable tray really speeds up installation and manages this with no loss of stability and load-bearing capacity. The moulded connectors for screwless quick mounting ensure extremely quick installation times, even for complex mounting operations. Load tests show that GR-Magic® systems can fully match up to traditional screw connections.



The mesh cable trays are available with side heights of 35, 55 and 105 mm in the electrogalvanised “Titan look” version, hot-dip galvanised version and in stainless steel. The comprehensive range of practical accessories, such as mesh cable tray bends, hold-down clamps, quick connectors, barrier strips, suspension profiles, brackets, etc., ensures that the product range is complete down to the smallest detail.

Compliant with standards

The electrical properties are also first class: the values required by the VDE guidelines 0639 and in the new IEC/EN 61537 "Cable management. Cable tray systems and cable ladder systems" are achieved easily.

In addition, the system satisfies the stringent NEMA requirements for the American market. As a result, the GR-Magic® mesh cable tray can also be used as a protective conductor.



Maintenance of the electrical supply

1

Laying system/support system:
GRM screwless straight connection, fire-tested

2

Safety cables:
E30-E90

3

Tested and approved cable system with the maintenance of electrical supply according to DIN 4102 Part 12

✓

Maintaining the electrical function with the GR-Magic®

1

GRM

2



3



✓



Maintaining the electrical function with the GR-Magic®

Besides rapid mounting and the wide range of applications, the GR-Magic® offers another key benefit: it can be used to maintain the electrical function for fire safety purposes in order to ensure the supply to safety-related systems for a certain period of time in the event of a fire. The GR-Magic® has proven its stability in an impressive manner in fire testing according to DIN 4102 Part 12.

This installation design was put through its paces with a cable load of 15 kg/m and a support distance of 1.5 m. Thanks to the GR-Magic®, a further support system is now available for which the maintenance of electrical functionality comes assured.

Impressive range of accessories

In addition to providing quick straight connections, the innovative GR-Magic® range of accessories is also easy to handle and use thanks to its screwless connections. For example, the mesh cable trays can be flexibly installed on mounting rails using fastening clips or on wall and support brackets using clamping lugs. Cut mesh cable trays without moulded connectors are easy to join together with a quick connector, while barrier strips are fastened with a hold-down clamp and cable exit plates with clamping lugs.



Magic down to the last detail

The system's effectiveness is provided by the perfectly formed mesh cable tray for screwless straight connection, complemented by the wide range of well-thought-out system components. The many lockable and clamp-on elements continue the basic principle of the Magic® system down to the last detail. Exceptional ease of use is also a priority for all additional fastening and system components, for example when creating bends of different radii with special corner connectors.



1	Mesh cable tray GR-Magic®
2	90° mesh cable tray bend
3	Quick connector
4	Mesh cable tray connector, long
5	Corner connector
6	Wall and central fastener
7	Mounting plate MPG
8	Wall and support bracket
9	Side holder
10	Centre suspension
11	Ceiling bracket, variable
12	Spacer clamp
13	Earthing terminal with earthing screw
14	Cable exit plate
15	Fastening element for junction boxes
16	Installation profile

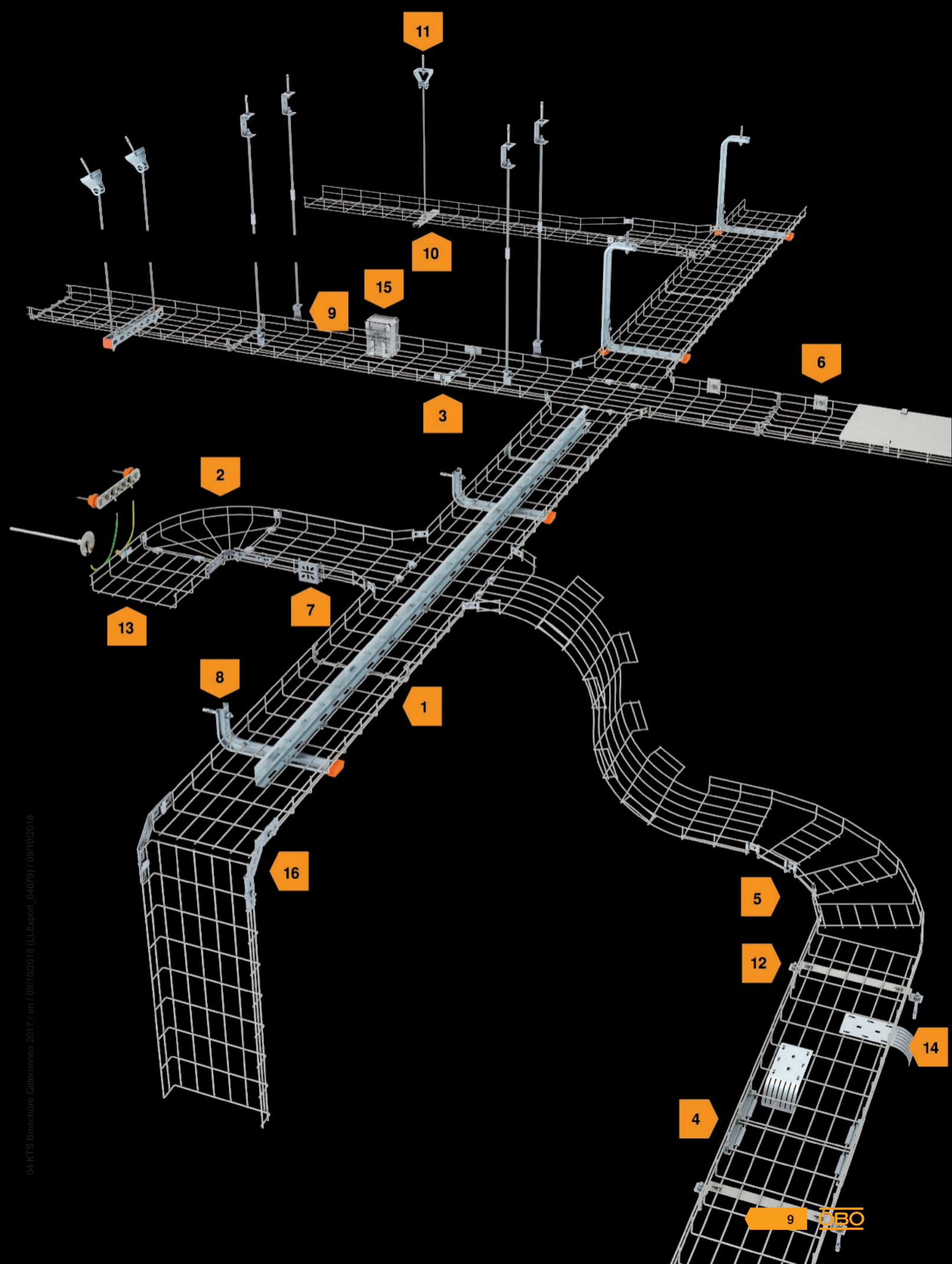

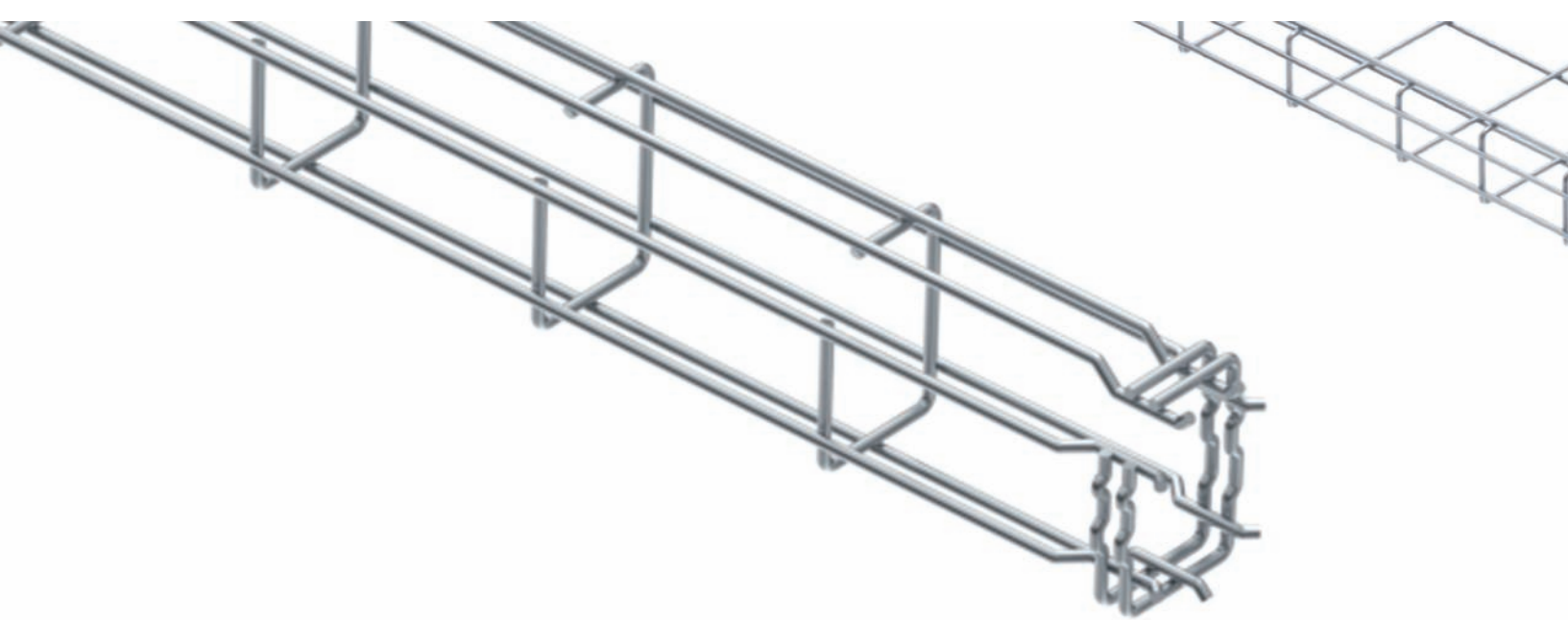

Magic® G mesh cable tray



G FT A2 A4

The system for direct wall and ceiling mounting



Optimum room usage

Even if space is tight, the Magic® G mesh cable tray can be mounted almost anywhere. It can be attached directly to walls and ceilings in almost any position, providing optimum cable routing particularly in false ceilings, server rooms and office buildings. This system also scores highly thanks to its screwless design.

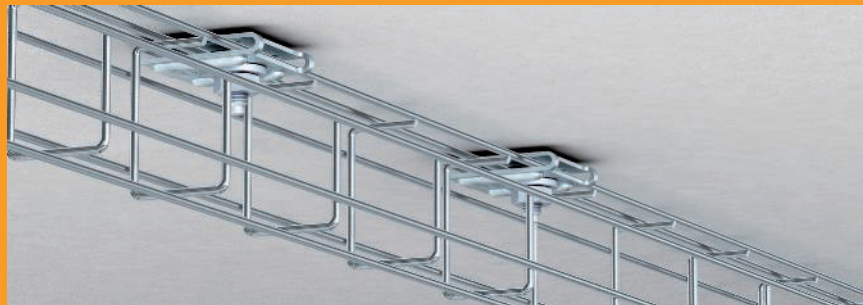

A variety of materials

In dry rooms, wet rooms, outdoor areas, the food industry or tunnel construction – the GR-Magic® has the right surface for any area. The product range runs from electrogalvanised and hot-dip galvanised right through to stainless steel variants.

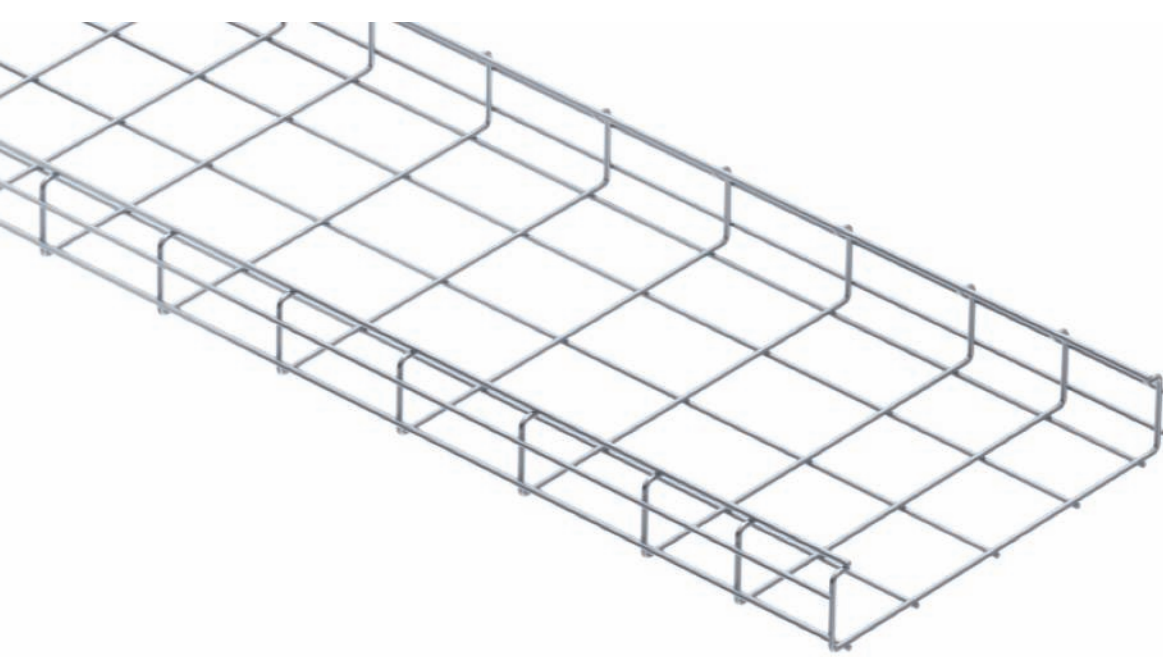

C mesh cable tray



FT A2

Maximum load-bearing capacity and versatility

The C mesh cable tray system from OBO Bettermann can fulfil the highest requirements for load capacities and versatility. The C shape allows support widths of up to three metres. With a side height of 50 mm and optimised accessories such as hold-down clamps, barrier strips or installation profiles, the system is the perfect complement to OBO's complete mesh cable tray portfolio. It is used both in industry and in all other areas of professional electrical installations.



A tough cookie: Heavy-duty SGR mesh cable tray made of 6 mm wire

Today, due to the wide range of applications, the requirements for mesh cable trays differ a great deal. Besides simple mounting, a high load capacity, dirt-repelling qualities, good ventilation behaviour and high-quality surface refinement are particularly in demand.

G FT A2

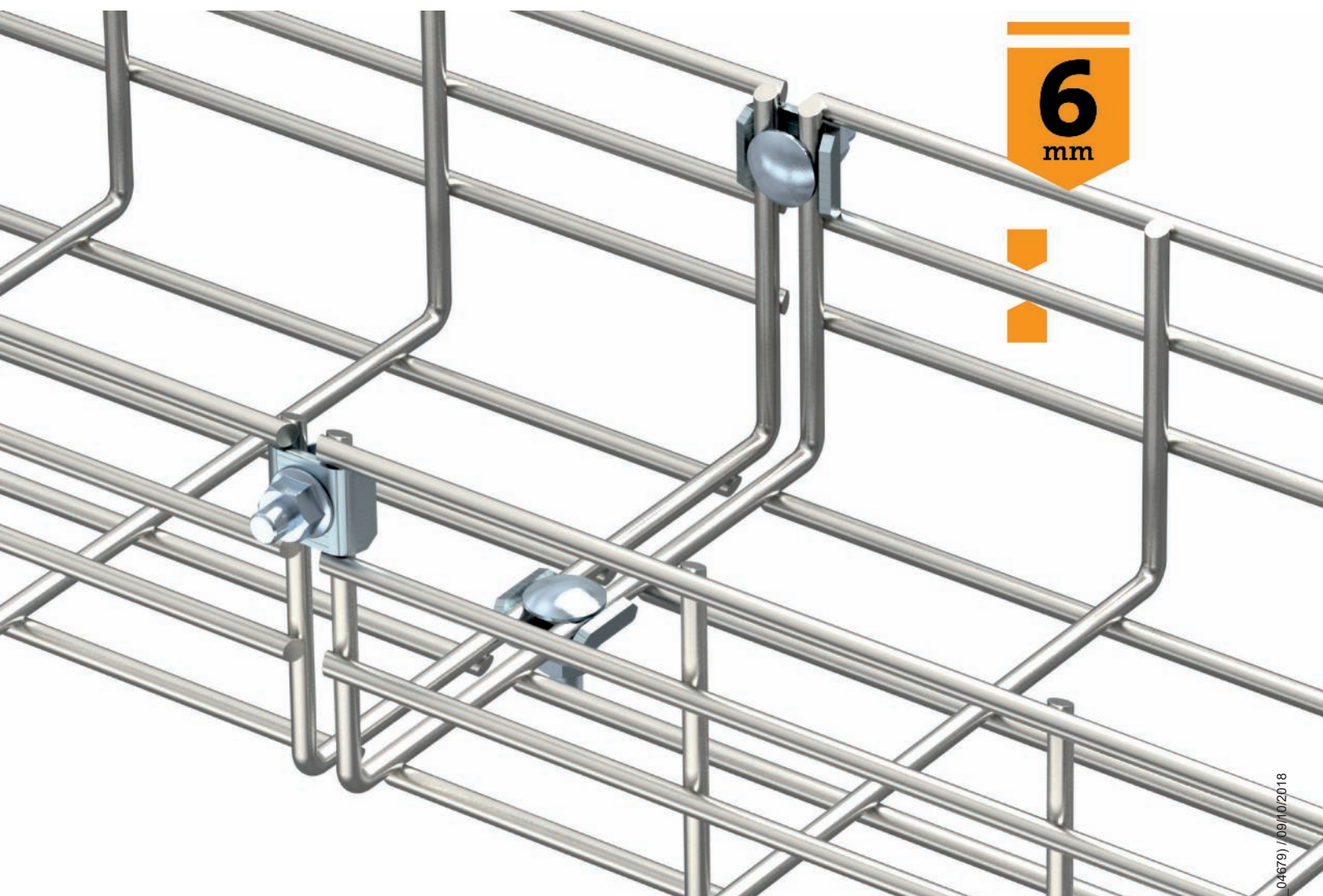

110 %

The new heavy-duty mesh cable tray of type SGR, made of 6 mm-thick wire in a U profile, combines many advantages all at the same time. The strong wire design means that the SGR, with its low intrinsic weight, can withstand load capacities of up to 110% more than the comparable mesh cable trays of competitors and can thus also be used for larger support spacings of up to 4.0 m.

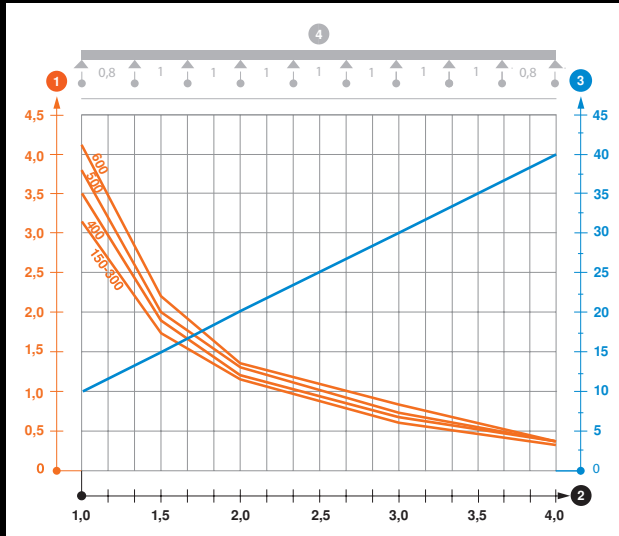

Load diagram, mesh cable tray, type SGR 105

- 1 Approved cable tray/ladder in kN/m without man load
- 2 Support width in m
- 3 Rail bend in mm at permitted kN/m
- 4 Load scheme during testing
- Load curve with cable tray/ladder width in mm
- Rail bend curve according to support width

The mesh cable tray is available in three different surface finishes. The hot-dip galvanised version can be used in the industrial sector and in machine and system construction. The stainless steel version is particularly suited to the foodstuffs and chemical industry sector and the electrogalvanised version is available for indoor areas with no specific demands.

With three different side heights, it is possible to react very flexibly to different cable volumes when necessary. The large mesh holes allow cables and lines to be fed in or out at any point.

In addition, the open structure prevents heat build-up and also the accumulation of dirt and dust is mostly prevented. Matching the heavy mesh cable tray, there is the GU 6 U connector in the surfaces FT, G and A2 available. This new heavy-duty mesh cable tray offers an all-round complete package for the sophisticated laying of cables in all different application areas.



Surface variety of the mesh cable tray

The mesh cable trays are available in a wide variety of surface designs that enable them to be used both indoors and outdoors. For indoors, OBO has developed the electrogalvanised surface further and made it even more visually appealing. The result is the new OBO “Titan look”. This provides the mesh cable trays with an unmistakable, high-quality optical appearance, which closely resembles stainless steel – making it ideal for use in false ceilings and where in view.

For use in aggressive environments as well as in the food industry, OBO offers the GR mesh cable tray in the stainless steel 1.4301 and 1.4401 versions. The mesh cable trays are made from quality stainless steel wires and pickled in a subsequent process. This protects the wires against extreme chemical loads. As they are taste-neutral and resistant to cleaning agents, disinfectants and sterilisers, these mesh cable tray systems can also be used in the food industry.



G

G	
Surface	Electrogalvanisation
Coating thickness	Average value approx. 2.5-10 µm
Standards	Electrolytic galvanisation in accordance with DIN EN 12329
Location of use	Indoors



FT

FT	
Surface	Hot-dip galvanisation
Coating thickness	Average value approx. 40-60 µm
Standards	Galvanisation according to the hot-dip method to DIN EN ISO 1461
Location of use	Outdoors

A2**A2**

Material	Stainless steel A2
Designations	European material designation: 1.4301 American material designation: AISI 304
Special features	Welded components are also passivated; unwelded components are rinsed and degreased
Location of use	Industrial areas with high levels of humidity and aggressive atmosphere, food industry, chemical and pharmaceuticals industry

A4**A4**

Material	Stainless steel A4
Designations	European material designation: 1.4401/1.4404/1.4571 American material designation: AISI 316/316L/316Ti
Special features	Welded components are also passivated; unwelded components are rinsed and degreased
Location of use	Buildings or areas with almost constant condensation and high levels of impurities, coastal or offshore areas with high levels of salt



Tested quality

The in-house BET Test Centre continually monitors and tests the quality of OBO products. Here, OBO simulates the loads that the mesh cable tray systems have to withstand on a constant basis. We determine the maximum load capacity and carrying capacity of the

system, as well as its resistance to corrosion. We are able to prove standardised testing of EMC properties using test reports. In other words, OBO places paramount importance on safety.

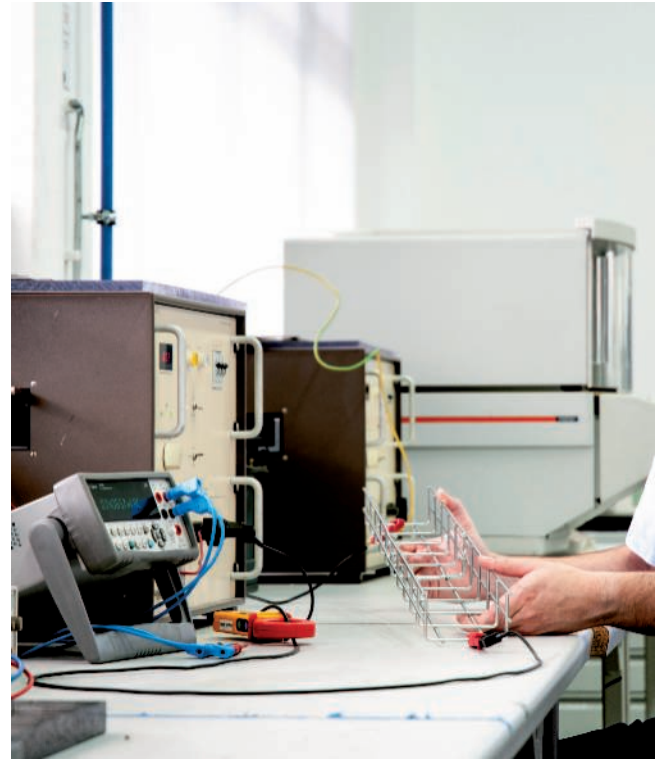
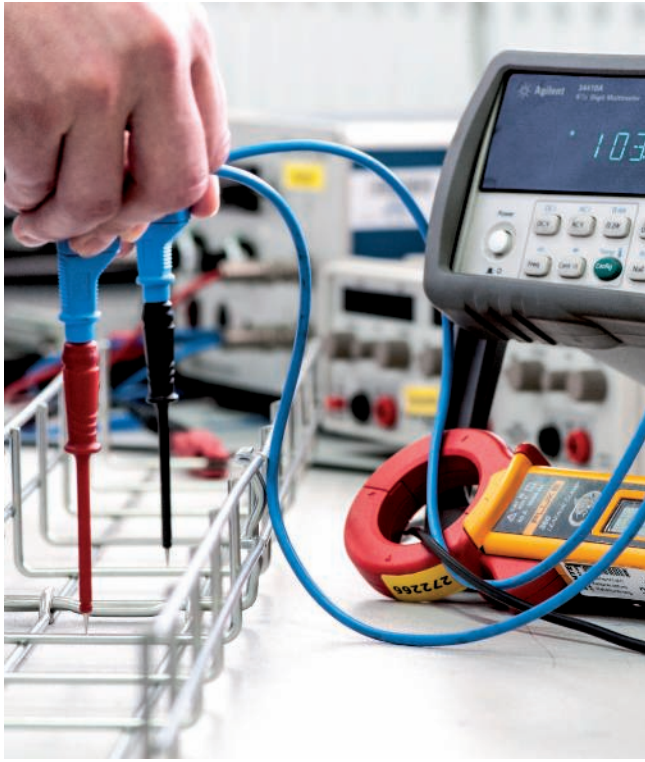

The KTS testing system was specially constructed for the testing of OBO Bettermann cable support systems. Thanks to its continuous further development and adaptation to the latest requirements, it

can offer comprehensive testing options. For example, the tests required by DIN EN 61537 can be carried out. These prove the safe working load (SWL) and therefore the reliable load-bearing capacity

of the systems. Tested quality without compromise – made by OBO.

As flexible as your work

Mesh cable trays cannot always be routed lengthways. Depending on the application, it is necessary to overcome structural obstacles or to make unusual changes of direction, horizontally and vertically. As the OBO mesh cable trays can be cut to size as required and the system has an extensive range of accessories, it can be adapted to any structural conditions.





Reference

- Lieken Brot-und Backwaren GmbH
- Product: Mesh cable tray in various widths and side heights
- Units: 2.5 km
- Location of use: Industrial and administrative areas

GR-Magic® mesh cable tray

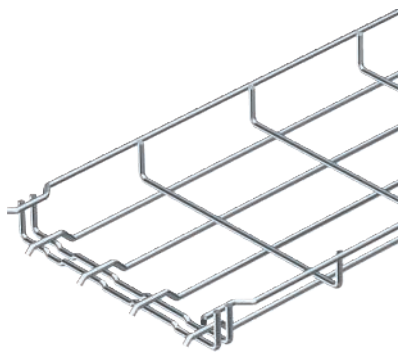

Type	Wire		Pack.	Weight	Item No.
	Width	Ø			
	mm	mm	m	kg/100 m	
GRM 35 50 G	50	3.9	3	45.300	6000060
GRM 35 100 G	100	3.9	3	49.000	6000062
GRM 35 150 G	150	3.9	3	63.100	6000063
GRM 35 200 G	200	3.9	3	76.800	6000064
GRM 35 300 G	300	4.8	3	159.100	6000066
GRM 35 50 FT	50	3.9	3	45.610	6000069
GRM 35 100 FT	100	3.9	3	50.400	6000071
GRM 35 150 FT	150	3.9	3	64.500	6000072
GRM 35 200 FT	200	3.9	3	78.600	6000073
GRM 35 300 FT	300	4.8	3	162.700	6000075

G Electrogalvanised **FT** Hot-dip galvanised

No additional connection components are required for the mesh cable tray, it is simply interlocked. The grid width is 50 x 100 mm (exception: GRM 35/50 = 20 x 100 mm).

Mesh cable tray with shaped connector of side height 35 mm.

Dimensions

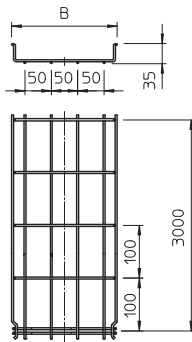

Type	Length	Dimen- sion B	Wire Ø	Useful cross-section
GRM 35 50 G	3000	50	3.9	17.5
GRM 35 100 G	3000	100	3.9	35
GRM 35 150 G	3000	150	3.9	52.5
GRM 35 200 G	3000	200	3.9	70
GRM 35 300 G	3000	300	4.8	105

Load

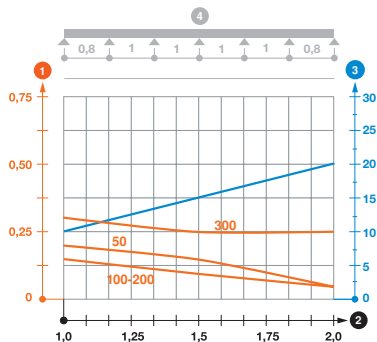

Type	1.0 m	1.5 m	2.0 m
	kN/m	kN/m	kN/m
GRM 35 50 G	0.25	0.11	0.1
GRM 35 100 G	0.25	0.11	0.1
GRM 35 150 G	0.25	0.11	0.1
GRM 35 200 G	0.3	0.14	0.1
GRM 35 300 G	0.75	0.22	0.15

Load diagram, GR-Magic mesh cable tray, type GRM 35

- ① Permitted cable tray/ladder load in kN/m without man load
- ② Support width in m
- ③ Rail bend in mm at permitted kN/m
- ④ Load scheme during testing
- Load curve with cable tray/ladder width in mm
- Strut bend curve according to support width

GR-Magic® mesh cable tray



Type	Wire		Pack. m	Weight kg/100 m	Item No.
	Width mm	Ø mm			
GRM 35 50VA4301	50	3.9	3	45.000	6000054
GRM 35 100VA4301	100	3.9	3	49.000	6000055
GRM 35 150VA4301	150	3.9	3	62.600	6000056
GRM 35 200VA4301	200	3.9	3	76.300	6000057
GRM 35 300VA4301	300	4.8	3	157.900	6000059
GRM 35 50VA4401	50	3.9	3	44.620	6000086
GRM 35 100VA4401	100	3.9	3	49.000	6000087
GRM 35 150VA4401	150	3.9	3	62.600	6000089
GRM 35 200VA4401	200	3.9	3	76.300	6000090
GRM 35 300VA4401	300	4.8	3	157.900	6000091

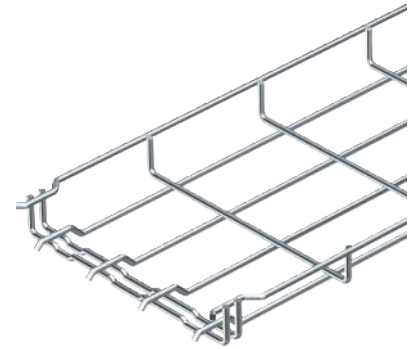

No additional connection components are required for the mesh cable tray, it is simply interlocked. The grid width is 50 x 100 mm (exception: GRM 35/50 = 20 x 100 mm).

Mesh cable tray with shaped connector of side height 35 mm.

Type	Length mm	Dimen- sion B mm	Wire Ø mm	Useful cross-section cm²
GRM 35 100VA4301	3000	100	3.9	35
GRM 35 150VA4301	3000	150	3.9	52.5
GRM 35 200VA4301	3000	200	3.9	70
GRM 35 300VA4301	3000	300	4.8	105

Dimensions

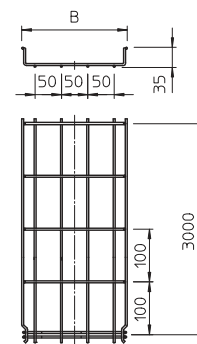

Load

Type	1.0 m	1.5 m	2.0 m
	kN/m	kN/m	kN/m
GRM 35 50VA4301	0.25	0.11	0.1
GRM 35 100VA4301	0.25	0.11	0.1
GRM 35 150VA4301	0.25	0.11	0.1
GRM 35 200VA4301	0.3	0.14	0.1
GRM 35 300VA4301	0.75	0.22	0.15

Load diagram, GR-Magic mesh cable tray, type GRM 35

- 1 Permitted cable tray/ladder load in kN/m without man load
- 2 Support width in m
- 3 Rail bend in mm at permitted kN/m
- 4 Load scheme during testing
- Load curve with cable tray/ladder width in mm
- Strut bend curve according to support width

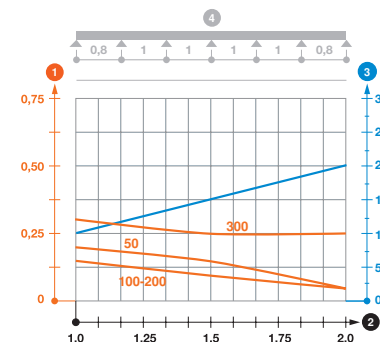

Barrier strip



Type	Dimension H mm	Plate thickness mm	Dimension L mm	Pack. m	Weight kg/100 m	Item No.
TSG 30 FS	30	0.75	3000	3	38.000	6062050
TSG 30 DD	30	0.75	3000	3	38.000	6062314
TSG 30 VA4301	30	0.75	3000	3	37.670	6062052
TSG 30 VA4571	30	0.75	3000	3	38.670	6062054

FS Strip-galvanised **DD** Strip galvanised zinc/aluminium, double dip
Barrier strip for separation of cables of different voltages or functions.

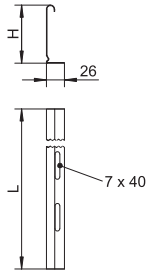

Barrier strip connector



Type	Pack. pcs	Weight kg/100 pcs.	Item No.
TSGV VA4310	10	0.923	6067970

Barrier strip connector for screwless connection of the TSG barrier strip in all side heights.

Hold-down clamp for barrier strip fastening

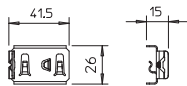

Type	Pack. pcs	Weight kg/100 pcs.	Item No.
KS GR VA4310	30	0.830	6062282

Hold-down clamp for fastening barrier strips in mesh cable trays.

Hold-down clamp for barrier strip fastening

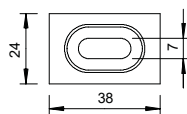
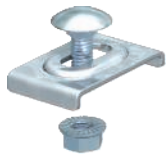

Type	Pack. pcs	Weight kg/100 pcs.	Item No.
GKT 38 G	20	2.300	6017037
GKT 38 FT	20	2.400	6017061
GKT 38 VA4301	20	2.200	6017045
GKT 38 VA4401	10	2.200	6017092

G Electrogalvanised **FT** Hot-dip galvanised
Including FRS M6 x 20 bolt with flange nut.
Clamp for fastening barrier strip in mesh cable trays.

GR-Magic® mesh cable tray



Type	Wire		Pack.	Weight	Item No.
	Width	Ø			
	mm	mm	m	kg/100 m	
GRM 55 50 G	50	3.9	3	67.000	6001441
GRM 55 100 G	100	3.9	3	72.400	6001442
GRM 55 150 G	150	3.9	3	85.700	6001444
GRM 55 200 G	200	3.9	3	100.667	6001446
GRM 55 200 4.8 G	200	4.8	3	151.000	6001447
GRM 55 300 G	300	4.8	3	194.900	6001448
GRM 55 400 G	400	4.8	3	236.700	6001450
GRM 55 450 G	450	4.8	3	238.000	6001451
GRM 55 500 G	500	4.8	3	279.000	6001452
GRM 55 600 G	600	4.8	3	321.200	6001454

G Electrogalvanised

No additional connection components are required for the mesh cable tray, it is simply interlocked. The grid width is 50 x 100 mm (exception: GRM 55/50 = 20 x 100 mm). Tested for the maintenance of electrical function according to DIN 4102 Part 12 (type: GRM 55 200 4.8 G, GRM 55 300 G, GRM 55 400 G, mounting work and parameters according to valid test certificate).

Tested for installation above suspended fire protection ceilings (type: GRM 55 100 G, GRM 55 200 G, GRM 55 300 G, GRM 55 400 G, fire load 30 minutes, mounting work and parameters according to fire protection reports).

Mesh cable tray with shaped connector of side height 55 mm.

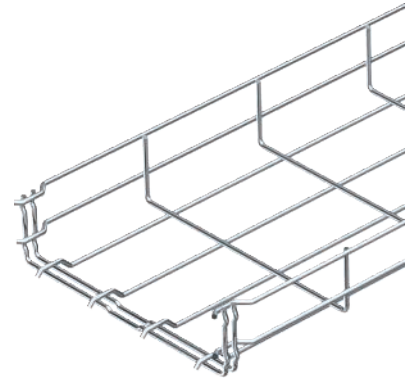

Type	Length	Dimen- sion B	Wire Ø	Useful cross-section
GRM 55 50 G	3000	50	3.9	16
GRM 55 100 G	3000	100	3.9	40
GRM 55 150 G	3000	150	3.9	63
GRM 55 200 G	3000	200	3.9	87
GRM 55 200 4.8 G	3000	200	4.8	87
GRM 55 300 G	3000	300	4.8	129
GRM 55 400 G	3000	400	4.8	175
GRM 55 450 G	3000	450	4.8	195
GRM 55 500 G	3000	500	4.8	220
GRM 55 600 G	3000	600	4.8	265

Dimensions

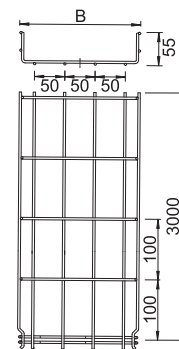

Load

Type	1.0 m	1.5 m	2.0 m	2.5 m
	kN/m	kN/m	kN/m	kN/m
GRM 55 50 G	0.35	0.2	0.1	0.1
GRM 55 100 G	0.35	0.2	0.1	0.1
GRM 55 150 G	0.35	0.2	0.1	0.1
GRM 55 200 G	0.35	0.2	0.1	0.1
GRM 55 200 4.8 G	0.7	0.5	0.25	0.2
GRM 55 300 G	0.7	0.5	0.25	0.2
GRM 55 400 G	0.9	0.6	0.3	0.25
GRM 55 450 G	0.9	0.6	0.3	0.25
GRM 55 500 G	0.9	0.6	0.3	0.25
GRM 55 600 G	0.9	0.6	0.3	0.25

Load diagram, GR-Magic mesh cable tray, type GRM 55

1 Permitted cable tray/ladder load in kN/m without man load

2 Support width in m

3 Rail bend in mm at permitted kN/m

4 Load scheme during testing

— Load curve with cable tray/ladder width in mm

— Strut bend curve according to support width

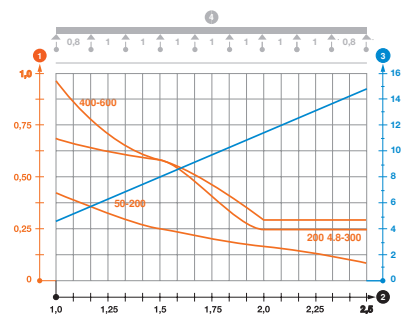

GR-Magic® mesh cable tray

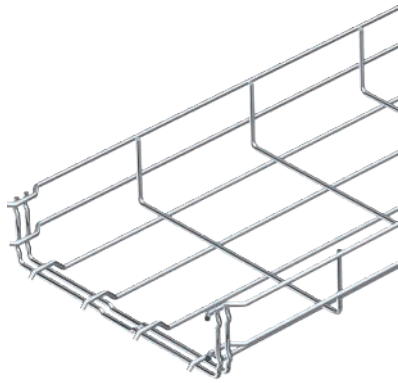

Type	Wire		Pack. m	Weight kg/100 m	Item No.
	Width mm	Ø mm			
GRM 55 50 FT	50	3.9	3	66.470	6001415
GRM 55 100 FT	100	3.9	3	75.667	6001416
GRM 55 150 FT	150	3.9	3	90.000	6001418
GRM 55 200 FT	200	3.9	3	104.667	6001420
GRM 55 200 4.8FT	200	4.8	3	154.300	6001421
GRM 55 300 FT	300	4.8	3	198.800	6001424
GRM 55 400 FT	400	4.8	3	244.300	6001428
GRM 55 500 FT	500	4.8	3	287.700	6001432
GRM 55 600 FT	600	4.8	3	331.600	6001436

FT Hot-dip galvanised

No additional connection components are required for the mesh cable tray, it is simply interlocked. The grid width is 50 x 100 mm (exception: GRM 55/50 = 20 x 100 mm).

Mesh cable tray with shaped connector of side height 55 mm.

Dimensions

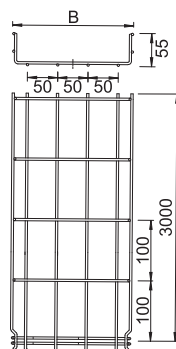

Load

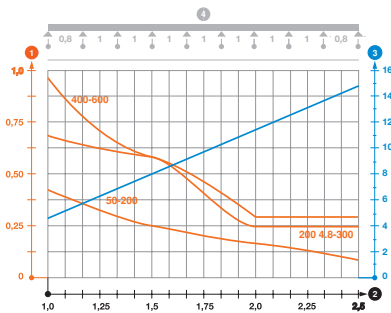

Type	Length mm	Dimension B mm	Wire Ø mm	Useful cross-section cm²
GRM 55 50 FT	3000	50	3.9	16
GRM 55 100 FT	3000	100	3.9	40
GRM 55 150 FT	3000	150	3.9	63
GRM 55 200 FT	3000	200	3.9	87
GRM 55 200 4.8FT	3000	200	4.8	87
GRM 55 300 FT	3000	300	4.8	129
GRM 55 400 FT	3000	400	4.8	175
GRM 55 500 FT	3000	500	4.8	220
GRM 55 600 FT	3000	600	4.8	265

Type	1.0 m kN/m	1.5 m kN/m	2.0 m kN/m	2.5 m kN/m
GRM 55 50 FT	0.35	0.2	0.1	0.1
GRM 55 100 FT	0.35	0.2	0.1	0.1
GRM 55 150 FT	0.35	0.2	0.1	0.1
GRM 55 200 FT	0.35	0.2	0.1	0.1
GRM 55 200 4.8FT	0.7	0.5	0.25	0.2
GRM 55 300 FT	0.7	0.5	0.25	0.2
GRM 55 400 FT	0.9	0.6	0.3	0.25
GRM 55 500 FT	0.9	0.6	0.3	0.25
GRM 55 600 FT	0.9	0.6	0.3	0.25

Load diagram, GR-Magic mesh cable tray, type GRM 55

1 Permitted cable tray/ladder load in kN/m without man load

2 Support width in m

3 Rail bend in mm at permitted kN/m

4 Load scheme during testing

— Load curve with cable tray/ladder width in mm

— Strut bend curve according to support width

GR-Magic® mesh cable tray



Type	Width mm	Wire Ø mm	Pack. m	Weight kg/100 m	Item No.
GRM 55 50VA4301	50	3.9	3	67.000	6001070
GRM 55 100VA4301	100	3.9	3	72.666	6001072
GRM 55 150VA4301	150	3.9	3	88.000	6001074
GRM 55 200VA4301	200	3.9	3	99.000	6001076
GRM 55 300VA4301	300	4.8	3	191.100	6001078
GRM 55 400VA4301	400	4.8	3	243.000	6001080
GRM 55 500VA4301	500	4.8	3	287.000	6001082
GRM 55 600VA4301	600	4.8	3	331.000	6001085
GRM 55 50VA4401	50	3.9	3	67.000	6001087
GRM 55 100VA4401	100	3.9	3	72.666	6001088
GRM 55 150VA4401	150	3.9	3	88.000	6001090
GRM 55 200VA4401	200	3.9	3	99.000	6001091
GRM 55 300VA4401	300	4.8	3	191.100	6001093
GRM 55 400VA4401	400	4.8	3	243.000	6001095
GRM 55 500VA4401	500	4.8	3	287.000	6001097
GRM 55 600VA4401	600	4.8	3	331.000	6001099

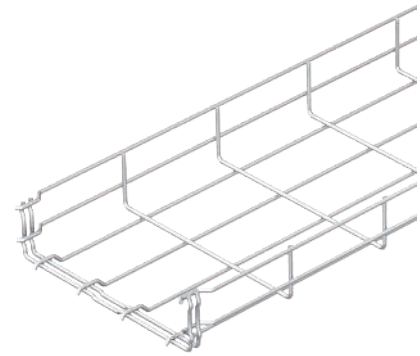

GB Stained

No additional connection components are required for the mesh cable tray, it is simply interlocked. The grid width is 50 x 100 mm (exception: GRM 55/50 = 20 x 100 mm). Mesh cable tray with shaped connector of side height 55 mm.

Type	Length mm	Dimen- sion B mm	Wire Ø mm	Useful cross- section cm ²
GRM 55 50VA4301	3000	50	3.9	16
GRM 55 100VA4301	3000	100	3.9	40
GRM 55 150VA4301	3000	150	3.9	63
GRM 55 200VA4301	3000	200	3.9	87
GRM 55 300VA4301	3000	300	4.8	129
GRM 55 400VA4301	3000	400	4.8	175
GRM 55 500VA4301	3000	500	4.8	220
GRM 55 600VA4301	3000	600	4.8	265

Dimensions

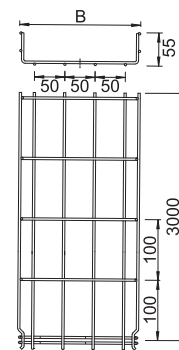

Type	1.0 m kN/m	1.5 m kN/m	2.0 m kN/m	2.5 m kN/m
GRM 55 50VA4301	0.35	0.2	0.1	0.1
GRM 55 100VA4301	0.35	0.2	0.1	0.1
GRM 55 150VA4301	0.35	0.2	0.1	0.1
GRM 55 200VA4301	0.35	0.2	0.1	0.1
GRM 55 300VA4301	0.7	0.5	0.25	0.2
GRM 55 400VA4301	0.9	0.6	0.3	0.25
GRM 55 500VA4301	0.9	0.6	0.3	0.25
GRM 55 600VA4301	0.9	0.6	0.3	0.25

Load

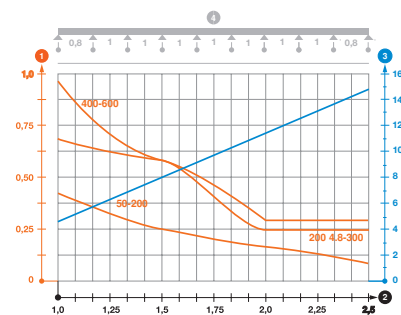

Load diagram, mesh cable tray GRM 55 VA

- 1 Permitted cable tray/ladder load in kN/m without man load
- 2 Support width in m
- 3 Rail bend in mm at permitted kN/m
- 4 Load scheme during testing
- Load curve with cable tray/ladder width in mm
- Strut bend curve according to support width

GR-Magic® mesh cable tray with barrier strip

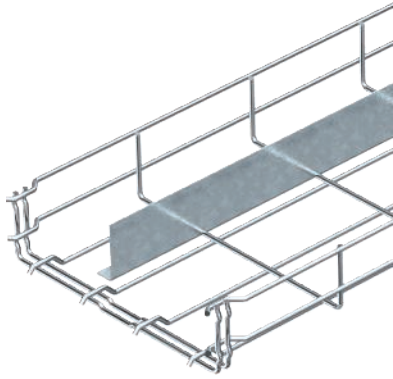

Type	Wire		Pack. m	Weight kg/100 m	Item No.
	Length mm	Ø mm			
GRM-T 55 100 G	3000	3.9	3	116.500	6006453
GRM-T 55 200 G	3000	3.9	3	143.340	6006455
GRM-T 55 300 G	3000	4.8	3	238.600	6006456
GRM-T 55 400 G	3000	4.8	3	280.800	6006457
GRM-T 55 500 G	3000	4.8	3	323.100	6006458

G Electrogalvanised

No additional connection components are required for the mesh cable tray, it is simply interlocked. The grid width is 50 x 100 mm.

Mesh cable tray with shaped connector and welded barrier strips of side height 55 mm.

Dimensions

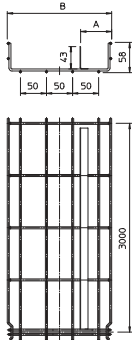

Type	Length mm	Dimen- sion B mm	Wire Ø mm	Useful cross-section cm ²
GRM-T 55 200 G	3000	200	3.9	87
GRM-T 55 300 G	3000	300	4.8	129
GRM-T 55 400 G	3000	400	4.8	175
GRM-T 55 500 G	3000	500	4.8	220

Load

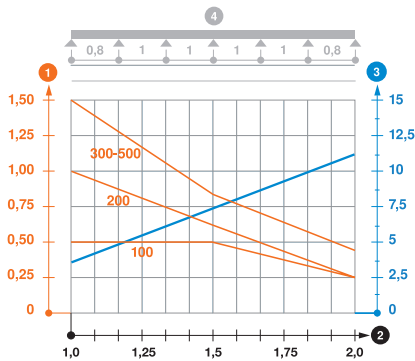

Type	1.0 m	1.5 m	2.0 m
	kN/m	kN/m	kN/m
GRM-T 55 100 G	0.5	0.5	0.25
GRM-T 55 200 G	1	0.6	0.25
GRM-T 55 300 G	1.5	0.8	0.4
GRM-T 55 400 G	1.5	0.8	0.4
GRM-T 55 500 G	1.5	0.8	0.4

Load diagram, GR-Magic mesh cable tray, type GRM-1T 55

- 1 Permitted cable tray/ladder load in kN/m without man load
- 2 Support width in m
- 3 Rail bend in mm at permitted kN/m
- 4 Load scheme during testing
- Load curve with cable tray/ladder width in mm
- Strut bend curve according to support width

GR-Magic® mesh cable tray with barrier strip

Type	Length mm	Wire Ø mm	Pack. m	Weight		Item No.
				kg/100 m		
GRM-2T 55 200 G	3000	3.9	3	188.200		6006395
GRM-2T 55 300 G	3000	4.8	3	282.700		6006396
GRM-2T 55 400 G	3000	4.8	3	336.700		6006397
GRM-2T 55 500 G	3000	4.8	3	367.200		6006468

G Electrogalvanised

No additional connection components are required for the mesh cable tray, it is simply interlocked. The grid width is 50 x 100 mm.

Mesh cable tray with shaped connector and two welded barrier strips of side height 55 mm.

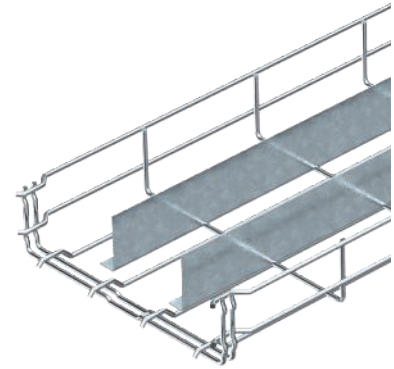

Type	Length mm	Dimen- sion B mm	Wire Ø mm	Useful
				cross- section cm ²
GRM-2T 55 200 G	3000	200	3.9	87
GRM-2T 55 300 G	3000	300	4.8	129
GRM-2T 55 400 G	3000	400	4.8	175
GRM-2T 55 500 G	3000	500	4.8	220

Dimensions

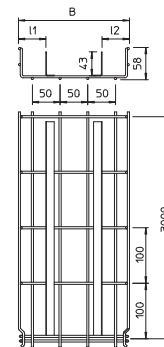

Type	1.0 m 1.5 m 2.0 m		
	kN/m	kN/m	kN/m
GRM-2T 55 200 G	2	1	0.4
GRM-2T 55 300 G	2.3	1.4	0.6
GRM-2T 55 400 G	2.3	1.4	0.6
GRM-2T 55 500 G	1.5	0.8	0.55

Load diagram, GR-Magic mesh cable tray, type GRM-2T 55

- 1 Permitted cable tray/ladder load in kN/m without man load
- 2 Support width in m
- 3 Rail bend in mm at permitted kN/m
- 4 Load scheme during testing
- Load curve with cable tray/ladder width in mm
- Strut bend curve according to support width

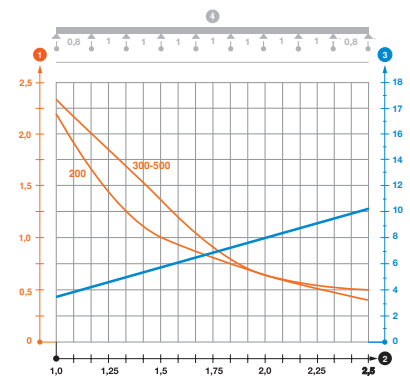

Load

Barrier strip

Type	Dimen- sion H mm	Plate thickness mm	Dimen- sion L mm	Pack. Weight		Item No.
				m	kg/100 m	
TSG 45 FS	45	0.75	3000	3	46.700	6062033
TSG 45 DD	45	0.75	3000	3	46.800	6062321
TSG 45 VA4301	45	0.75	3000	3	47.000	6062025
TSG 45 VA4571	45	0.75	3000	3	48.000	6062028

FS Strip-galvanised **DD** Strip galvanised zinc/aluminium, double dip

Barrier strip for separation of cables of different voltages or functions.

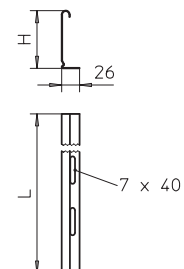

Barrier strip connector

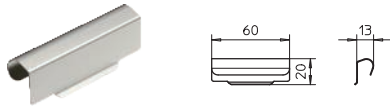

Type

TSGV VA4310

Barrier strip connector for screwless connection of the TSG barrier strip in all side heights.

Pack. pcs	Weight		Item No.
	kg/100 pcs.	pcs.	
10	0.923		6067970

Hold-down clamp for barrier strip fastening

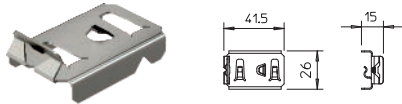

Type

KS GR VA4310

Hold-down clamp for fastening barrier strips in mesh cable trays.

Pack. pcs	Weight		Item No.
	kg/100 pcs.	pcs.	
30	0.830		6062282

Hold-down clamp for barrier strip fastening

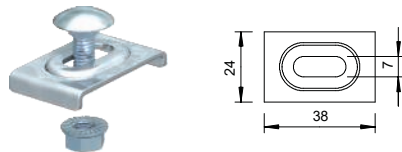

Type

GKT 38 G

GKT 38 FT

GKT 38 VA4301

GKT 38 VA4401

G Electrogalvanised **FT** Hot-dip galvanised
Including FRS M6 x 20 bolt with flange nut.
Clamp for fastening barrier strip in mesh cable trays.

Pack. pcs	Weight		Item No.
	kg/100 pcs.	pcs.	
20	2.300		6017037
20	2.400		6017061
20	2.200		6017045
10	2.200		6017092

90° mesh cable tray bend

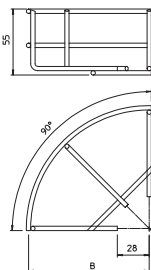
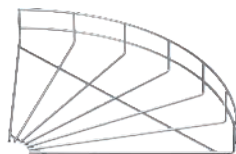

Type	Wire		Pack. pcs	Weight		Item No.
	Width mm	Ø mm		kg/100 pcs.	pcs.	
GRB 90 510 G	100	3.9	1	7.000		6001920
GRB 90 515 G	150	3.9	1	14.400		6001998
GRB 90 520 G	200	3.9	1	18.400		6001939
GRB 90 530 G	300	4.4	1	41.700		6001947
GRB 90 540 G	400	4.8	1	65.500		6001955
GRB 90 550 G	500	4.8	1	94.800		6001963
GRB 90 560 G	600	4.8	1	113.300		6001971
GRB 90 510 FT	100	3.9	1	7.500		6002218
GRB 90 515 FT	150	3.9	1	15.100		6002222
GRB 90 520 FT	200	3.9	1	19.300		6002226
GRB 90 530 FT	300	4.4	1	43.500		6002234
GRB 90 540 FT	400	4.8	1	68.000		6002242
GRB 90 550 FT	500	4.8	1	98.400		6002250
GRB 90 560 FT	600	4.8	1	113.700		6002269

G Electrogalvanised **FT** Hot-dip galvanised
90° bend, horizontal, for all mesh cable trays of 55 mm side height.

GR-Magic® mesh cable tray

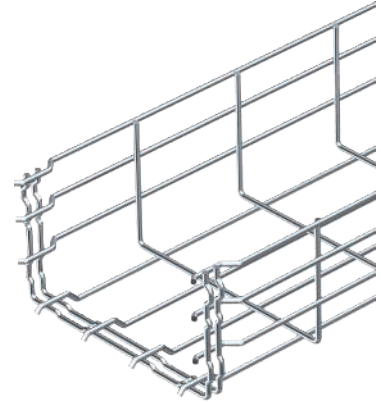

Type	Width		Pack.	Weight	Item No.
	mm	Wire Ø mm			
GRM 105 100 G	100	3.9	3	99.340	6002402
GRM 105 150 G	150	3.9	3	110.600	6002404
GRM 105 200 G	200	4.8	3	192.340	6002406
GRM 105 300 G	300	4.8	3	236.700	6002408
GRM 105 400 G	400	4.8	3	278.000	6002410
GRM 105 450 G	450	4.8	3	300.000	6002413
GRM 105 500 G	500	4.8	3	319.000	6002415
GRM 105 600 G	600	4.8	3	363.300	6002417
GRM 105 100 FT	100	3.9	3	103.700	6002431
GRM 105 150 FT	150	3.9	3	116.000	6002433
GRM 105 200 FT	200	4.8	3	200.700	6002435
GRM 105 300 FT	300	4.8	3	244.000	6002437
GRM 105 400 FT	400	4.8	3	287.700	6002439
GRM 105 450 FT	450	4.8	3	309.700	6002441
GRM 105 500 FT	500	4.8	3	333.000	6002443
GRM 105 600 FT	600	4.8	3	375.000	6002445

G Electrogalvanised FT Hot-dip galvanised

No additional connection components are required for the mesh cable tray, it is simply interlocked. The grid width is 50 x 100 mm.

Mesh cable tray with shaped connector of side height 105 mm.

Type	Length mm	Dimension B mm	Wire Ø mm	Useful
				cross-section cm ²
GRM 105 100 G	3000	100	3.9	82
GRM 105 150 G	3000	150	3.9	130
GRM 105 200 G	3000	200	4.8	175
GRM 105 300 G	3000	300	4.8	268
GRM 105 400 G	3000	400	4.8	363
GRM 105 450 G	3000	450	4.8	411
GRM 105 500 G	3000	500	4.8	459
GRM 105 600 G	3000	600	4.8	554

Dimensions

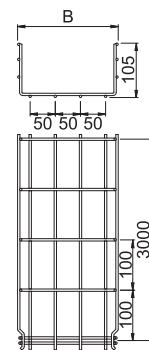

Type	1.0 m	1.5 m	2.0 m	3.0 m
	kN/m	kN/m	kN/m	kN/m
GRM 105 100 G	0.8	0.55	0.37	0.25
GRM 105 150 G	0.8	0.55	0.37	0.25
GRM 105 200 G	1	0.7	0.4	0.25
GRM 105 300 G	1.6	0.8	0.5	0.3
GRM 105 400 G	1.6	0.8	0.5	0.3
GRM 105 450 G	1.6	0.8	0.5	0.3
GRM 105 500 G	1.6	0.8	0.5	0.3
GRM 105 600 G	1.6	0.8	0.5	0.3

Load

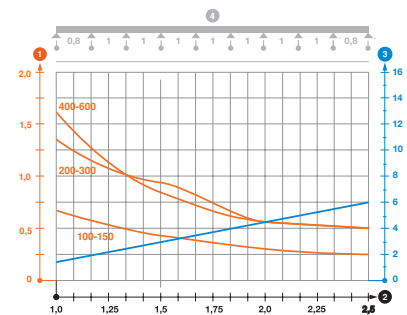

Load diagram, mesh cable tray, type GRM 105

- 1 Permitted cable tray/ladder load in kN/m without man load
- 2 Support width in m
- 3 Rail bend in mm at permitted kN/m
- 4 Load scheme during testing
- Load curve with cable tray/ladder width in mm
- Strut bend curve according to support width

GR-Magic® mesh cable tray

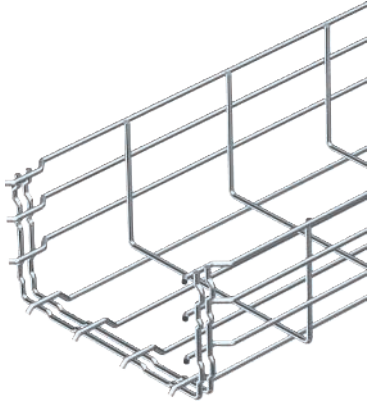

Type	Width		Pack.	Weight	Item No.
	mm	Wire Ø mm			
GRM105 100VA4301	100	3.9	3	99.000	6002451
GRM105 150VA4301	150	3.9	3	111.670	6002455
GRM105 200VA4301	200	4.8	3	200.670	6002457
GRM105 300VA4301	300	4.8	3	235.000	6002460
GRM105 400VA4301	400	4.8	3	277.000	6002463
GRM105 500VA4301	500	4.8	3	319.000	6002466
GRM105 600VA4301	600	4.8	3	363.340	6002469
GRM105 100VA4401	100	3.9	3	99.000	6002475
GRM105 150VA4401	150	3.9	3	109.130	6002476
GRM105 200VA4401	200	4.8	3	192.340	6002477
GRM105 300VA4401	300	4.8	3	235.000	6002479
GRM105 400VA4401	400	4.8	3	277.000	6002481
GRM105 500VA4401	500	4.8	3	319.000	6002483
GRM105 600VA4401	600	4.8	3	363.340	6002485

GB Stained

No additional connection components are required for the mesh cable tray, it is simply interlocked. The grid width is 50 x 100 mm.

Mesh cable tray with shaped connector of side height 105 mm.

Dimensions

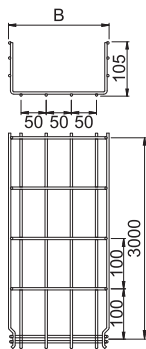

Load

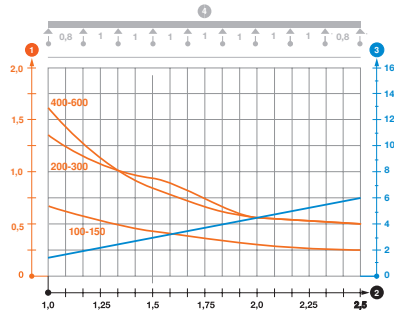

Type	Length mm	Dimen- sion B mm	Wire Ø mm	Useful cross-section cm ²
GRM105 150VA4301	3000	150	3.9	130
GRM105 200VA4301	3000	200	4.8	175
GRM105 300VA4301	3000	300	4.8	268
GRM105 400VA4301	3000	400	4.8	363
GRM105 500VA4301	3000	500	4.8	459
GRM105 600VA4301	3000	600	4.8	554

Type	1.0 m	1.5 m	2.0 m	3.0 m
	kN/m	kN/m	kN/m	kN/m
GRM105 100VA4301	0.8	0.55	0.37	0.25
GRM105 150VA4301	0.8	0.55	0.37	0.25
GRM105 200VA4301	0.8	0.55	0.37	0.25
GRM105 300VA4301	1.1	0.75	0.53	0.3
GRM105 400VA4301	1.1	0.75	0.53	0.3
GRM105 500VA4301	1.25	0.85	0.6	0.3
GRM105 600VA4301	1.25	0.85	0.6	0.3

Load diagram, mesh cable tray, type GRM 105

- 1 Permitted cable tray/ladder load in kN/m without man load
- 2 Support width in m
- 3 Rail bend in mm at permitted kN/m
- 4 Load scheme during testing
- Load curve with cable tray/ladder width in mm
- Strut bend curve according to support width

Barrier strip

Type	Dimen- sion H mm	Plate thickness mm	Dimen- sion L mm	Pack. Weight		Item No.
				m	kg/100 m	
TSG 85 FS	85	0.75	3000	3	70.300	6062114
TSG 85 DD	85	0.75	3000	3	70.300	6062331
TSG 85 VA4301	85	0.75	3000	3	69.670	6062173

FS Strip-galvanised **DD** Strip galvanised zinc/aluminium, double dip

Barrier strip for separation of cables of different voltages or functions.

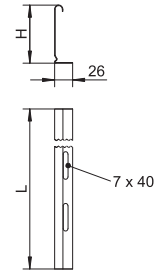

Barrier strip connector

Type	Pack. Weight		Item No.
	pcs	kg/100 pcs.	
TSGV VA4310	10	0.923	6067970

Barrier strip connector for screwless connection of the TSG barrier strip in all side heights.

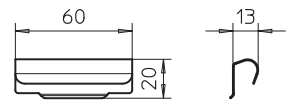

Hold-down clamp for barrier strip fastening

Type	Pack. Weight		Item No.
	pcs	kg/100 pcs.	
KS GR VA4310	30	0.830	6062282

Hold-down clamp for fastening barrier strips in mesh cable trays.

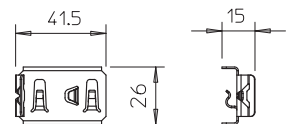

Hold-down clamp for barrier strip fastening

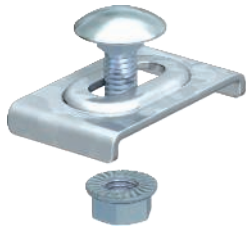

Type	Pack. pcs	Weight kg/100 pcs.	Item No.
GKT 38 G	20	2.300	6017037
GKT 38 FT	20	2.400	6017061
GKT 38 VA4301	20	2.200	6017045
GKT 38 VA4401	10	2.200	6017092

G Electrogalvanised **FT** Hot-dip galvanised

Including FRS M6 x 20 bolt with flange nut.

Clamp for fastening barrier strip in mesh cable trays.

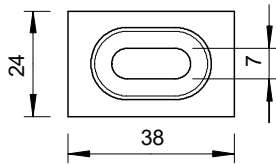

90° mesh cable tray bend

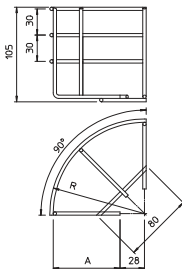
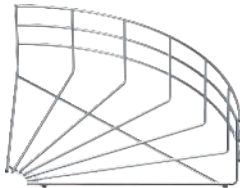

Type	Wire		Pack. pcs	Weight kg/100 pcs.	Item No.
	Width mm	Ø mm			
GRB 90 110 G	100	3.9	1	9.500	6002370
GRB 90 115 G	150	3.9	1	18.000	6002372
GRB 90 120 G	200	4.4	1	30.400	6002374
GRB 90 130 G	300	4.8	1	61.000	6002376
GRB 90 140 G	400	4.8	1	77.000	6002378
GRB 90 145 G	450	4.8	1	100.000	6002380
GRB 90 150 G	500	4.8	1	114.000	6002382
GRB 90 160 G	600	4.8	1	134.000	6002384
GRB 90 110 FT	100	3.9	1	10.000	6002307
GRB 90 115 FT	150	3.9	1	19.000	6002311
GRB 90 120 FT	200	4.4	1	36.000	6002315
GRB 90 130 FT	300	4.8	1	62.000	6002323
GRB 90 140 FT	400	4.8	1	81.900	6002331
GRB 90 145 FT	450	4.8	1	102.000	6002335
GRB 90 150 FT	500	4.8	1	113.000	6002358
GRB 90 160 FT	600	4.8	1	133.000	6002366

G Electrogalvanised **FT** Hot-dip galvanised

90° bend, horizontal, for all mesh cable trays of 105 mm side height.

Joint connector

Type	Pack. pcs	Weight kg/100 pcs.	Item No.
GSV 34 G	20	3.000	6016596
GSV 34 FT	20	3.000	6016634
GSV 34 VA4301	20	3.000	6016642
GSV 34 VA4401	20	3.000	6016648

G Electrogalvanised **FT** Hot-dip galvanised

Including FRS M6 x 20 bolt with flange nut.

Screwed version of joint connector for mesh cable trays.

Figure: Positioning and quantity of mesh cable tray connectors.

- 50–150 mm = 2 units
- 200–300 mm = 3 units
- 400–450 mm = 4 units
- 500–600 mm = 5 units

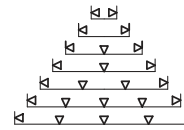
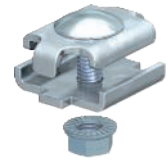
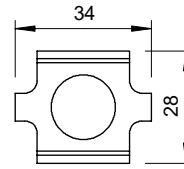

Quick connector

Type	Pack. pcs	Weight kg/100 pcs.	Item No.
GRS 3.9 DD	50	2.500	6016545
GRS 4.8 DD	50	2.500	6016561

DD Strip galvanised zinc/aluminium, double dip

When selecting the connector, please take the appropriate wire thickness of the mesh cable tray into account.

Quick connector for screwless straight connection of mesh cable trays without special tools, for mesh cable trays up to a width of 150 mm.

Figure: Positioning and quantity of mesh cable tray connectors.

- 50–150 mm = 2 units

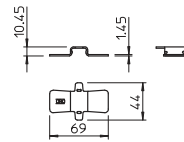

Mesh cable tray connector, long

Type	Width mm	Pack. pcs	Weight kg/100 pcs.	Item No.
GRV 245 FS	245	20	13.500	6016680
GRV 245 DD	245	20	13.500	6016684
GRV 245 VA4404	245	20	13.500	6016688

FS Strip-galvanised **DD** Strip galvanised zinc/aluminium, double dip

Two straight connectors, type GRV 245, are used for each connection point.

Can be used from a mesh cable tray width of 100 mm.

The FS variant is used to connect electrogalvanised mesh cable trays, the DD variant to connect hot/hot-dip galvanised mesh cable trays and the VA variant to connect stainless steel mesh cable trays.

Long mesh cable tray connectors for screwless straight connection of mesh cable trays.

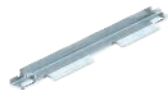
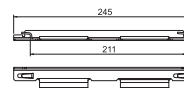

Side connector

Type	Pack. pcs	Weight kg/100 pcs.	Item No.
K 11 262 FT	25	7.500	6015107
K 11 262 VA4301	25	7.500	6016367

FT Hot-dip galvanised

Including screw of type FRS M6 x 20.

Screwed version of joint connector for mesh cable trays.

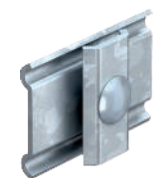

Corner connector

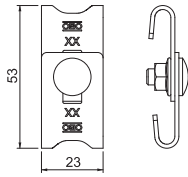

Type

Type	Pack. pcs	Weight kg/100 pcs.	Item No.
GEV 36 G	20	3.040	6016715
GEV 36 FT	20	3.000	6016723
GEV 36 VA4301	20	3.000	6016731
GEV 36 VA4401	10	3.000	6016764

G Electrogalvanised FT Hot-dip galvanised

Including FRS M6 x 12 bolt with flange nut

Corner connector for the creation of mesh cable tray bend elements.

Slotted steel strap

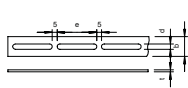

Type	Dimension mm	Hole size mm	Length mm	Pack. pcs	Weight kg/100 pcs.	Item No.
5050 20X3 1M FT	20 x 3	6,5 x 40	1000	20	35.000	1466504

FT Hot-dip galvanised

Perforated slotted steel strap in strips.

Slotted steel strap, bent

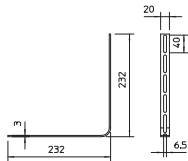

Type	Dimension mm	Pack. pcs	Weight kg/100 pcs.	Item No.
OSG 20X3 FT	20x3	25	15.800	6017371

FT Hot-dip galvanised

Set includes four clamps, type GKS 34.

Bent slotted steel strap for creation of bends and tees.

Hold-down clamp

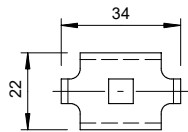

Type	Pack. pcs	Weight kg/100 pcs.	Item No.
GKS 34 G	20	2.000	6016855
GKS 34 FT	20	2.000	6016820
GKS 34 VA4301	20	2.000	6016839
GKS 34 VA4401	10	2.000	6016859

G Electrogalvanised FT Hot-dip galvanised

Including FRS M6 x 20 bolt with flange nut.

Clamp for fixing mesh cable trays to wall or support brackets.

Hold-down clamp

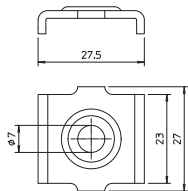
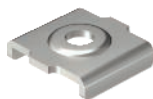

Type	Pack. pcs	Weight kg/100 pcs.	Item No.
GKB 34 G	20	1.000	6016674
GKB 34 VA4301	20	1.000	6016676

G Electrogalvanised

Clamp for fastening mesh cable trays of width 50 mm to the floor.

Hold-down clamp

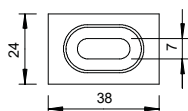

Type	Pack. pcs	Weight kg/100 pcs.	Item No.
GKB 38 G	20	1.200	6017020
GKB 38 VA4301	20	1.200	6017018

G Electrogalvanised

Hold-down clamp for floor fastening of mesh cable trays.

Hold-down clamp

Type	Hole Ø mm	Pack. pcs	Weight		Item No.
			kg/100 pcs.	Item No.	
GKS 50 07 FS	7	50	4.000	6015263	
GKS 50 11 FS	11	50	4.000	6015276	
GKS 50 07 FT	7	50	4.100	6015271	
GKS 50 11 FT	11	50	4.100	6015278	
GKS 50 07 V4A	7	50	4.000	6015310	
GKS 50 11 V4A	11	20	4.000	6015280	

FS Strip-galvanised FT Hot-dip galvanised

Hold-down clamp for fastening mesh cable trays on the ground or on stand-off brackets of type DBL.

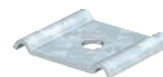
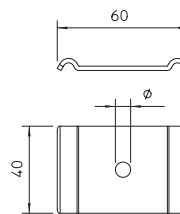

Earthing clip

Type	Shipping box pcs	Pack. pcs	Weight		Item No.
			kg/100 pcs.	Item No.	
939	150	25	5.932	5043107	

G Electrogalvanised

- For cables to 16 mm² and flat conductors
- Fit: cable to 16 mm² x max. FL 30
- With riveted brass connection terminal and one cylinder bolt, M5 x 12, with two cylinder bolts, M6 x 16

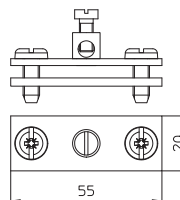

Connection and earthing terminal

Type	Pack. pcs	Weight		Item No.
		kg/100 pcs.	Item No.	
VEK-GRM 3.9 FS	25	3.850	6016694	
VEK-GRM 4.8 FS	25	3.800	6016696	

FS Strip-galvanised

The connection and earthing terminal is used to reduce electrical resistance and therefore improves the electric conductivity in GRM mesh cable systems in the area of the joint. This allows fulfilment of the high demands in terms of the transition resistance according to, for example, NEMA and CSA. Furthermore, the connection and earthing terminal is compulsory when used as a protective conductor in a mesh cable tray system (national regulations have to be followed when creating such a system).

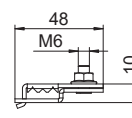

Earthing screw

Type	Dimen- Dimen- Cross- sion L sion l section mm mm mm ² Thread				Pack. pcs	Weight		Item No.
	mm	mm	mm ²	Thread		kg/100 pcs.	Item No.	
EKL 25 M6	22	8	25	M6	50	3.100	6404006	
EKL 35 M6	26	10	35	M6	50	4.800	6404014	

Earthing terminal for fastening the equipotential bonding conductor to the cable support system.

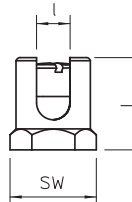

Side holder for cable gland

Type	Hole Ø mm	Pack. pcs	Weight		Item No.
			kg/100 pcs.	Item No.	
SH KAB 20 FS	20	10	15.000	6015425	
SH KAB 25 FS	25	10	14.700	6015433	

FS Strip-galvanised

Conduit take off bracket with perforation for accepting cable glands.

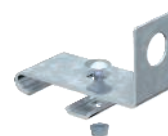
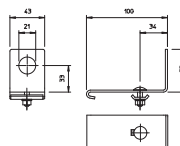

Drop-out plate

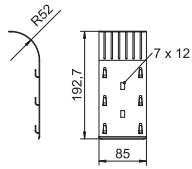

Type

Type	Pack. pcs	Weight kg/100 pcs.	Item No.
KAB GR FS	10	14.100	6220139
KAB GR FT	10	14.100	6220142
KAB GR VA 1.4301	10	14.100	6220145

FS Strip-galvanised **FT** Hot-dip galvanised

The drop-out plate allows compliance with specific bend radii, thus preventing possible cable breaks. Can be mounted in a lengthwise direction and at the side, can be arranged for greater widths.

Mounting plate

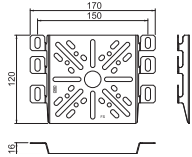

Type	Height mm	Width mm	Pack. pcs	Weight kg/100 pcs.	Item No.
MP UNI FS	115	170	40	13.300	7084773
MP UNI DD	115	170	40	11.000	7085114
MP UNI VA4301	115	170	40	11.000	7085133

FS Strip-galvanised **DD** Strip galvanised zinc/aluminium, double dip

Mounting plate, for fastening on the side rail of cable support systems.

Fastening element for mesh cable tray

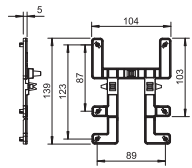

Type

Type	Pack. pcs	Weight kg/100 pcs.	Item No.
BE TS GR	10	2.300	2007833

The fastening element BE TS GR can be used to attach OBO junction boxes, type T60 and T100, to mesh cable trays quickly and in a few actions.

This keeps the junction box securely in position. However, it can be quickly dismantled as necessary.

Identification clip

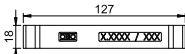
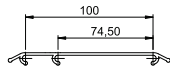

Type

Colour
Weight kg/100 pcs.
Pack. pcs
Item No.



KS GR OR	KS GR ZGB	KS GR LBL	KS GR SGN
Pastel orange	Zinc yellow	Light blue	Signal green
0.920	0.742	0.920	0.920
10	10	10	10
6017712	6017713	6017714	6017715

The identification clip is fastened to the mesh cable tray without screws simply by attaching it.

Bolt cutter



Type	Length mm	Pack. pcs	Weight kg/100 pcs.	Item No.
GR BS	450	1	160.000	6017700

Bolt cutter for cutting mesh cable trays.

Protective caps

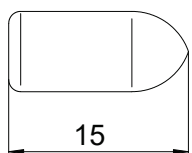

Type	Colour	Pack. pcs	Weight kg/100 pcs.	Item No.
GR KS 3.9 OR	Pure orange	500	0.025	6003750
GR KS 4.8 OR	Pure orange	500	0.030	6003754

End cap to cover cut wire ends of mesh cable trays.

Cover, unperforated

Type	Dimension B mm	Plate thickness mm	Length mm	Pack. m	Weight kg/100 m	Item No.
DRLU 050 FS	50	0.75	3000	3	59.770	6052056
DRLU 100 FS	100	0.75	3000	3	99.000	6052103
DRLU 150 FS	150	0.75	3000	3	138.270	6052153
DRLU 200 FS	200	1.00	3000	3	177.500	6052210
DRLU 300 FS	300	1.00	3000	3	256.000	6052307
DRLU 400 FS	400	1.00	3000	3	334.670	6052405
DRLU 500 FS	500	1.25	3000	3	619.230	6052512
DRLU 600 FS	600	1.25	3000	3	737.000	6052609
DRLU 050 DD	50	0.75	3000	3	59.770	6052640
DRLU 100 DD	100	0.75	3000	3	99.000	6052643
DRLU 150 DD	150	0.75	3000	3	138.270	6052647
DRLU 200 DD	200	1.00	3000	3	177.500	6052650
DRLU 300 DD	300	1.00	3000	3	256.000	6052656
DRLU 400 DD	400	1.00	3000	3	334.500	6052662
DRLU 500 DD	500	1.25	3000	3	619.230	6052668
DRLU 600 DD	600	1.25	3000	3	737.000	6052674
DRLU 050 VA4301	50	1.00	3000	3	59.770	6052821
DRLU 100 VA4301	100	1.00	3000	3	99.000	6052824
DRLU 150 VA4301	150	1.00	3000	3	138.240	6052828
DRLU 200 VA4301	200	1.00	3000	3	177.500	6052831
DRLU 300 VA4301	300	1.00	3000	3	256.000	6052834
DRLU 400 VA4301	400	1.00	3000	3	334.500	6052837
DRLU 500 VA4301	500	1.25	3000	3	619.170	6052841
DRLU 600 VA4301	600	1.25	3000	3	736.900	6052844
DRLU 050 VA4571	50	1.00	3000	3	59.670	6052978
DRLU 100 VA4571	100	1.00	3000	3	99.000	6052991
DRLU 150 VA4571	150	1.00	3000	3	138.240	6052992
DRLU 200 VA4571	200	1.00	3000	3	177.500	6052993
DRLU 300 VA4571	300	1.00	3000	3	256.000	6052994
DRLU 400 VA4571	400	1.00	3000	3	334.500	6052995
DRLU 500 VA4571	500	1.25	3000	3	619.170	6052996
DRLU 600 VA4571	600	1.25	3000	3	736.900	6052998

FS Strip-galvanised DD Strip galvanised zinc/aluminium, double dip

Transverse bead from 500 mm width.

Cover for cable trays and mesh cable trays.

When using covers outdoors, additional measures against the influence of wind must be taken.

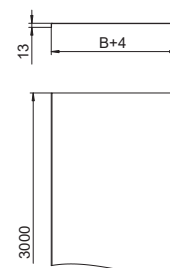
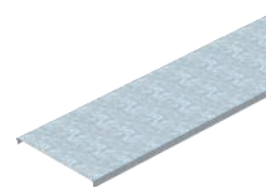

Cover clamp, universal

Type	Pack. pcs	Weight kg/100 pcs.	Item No.
DKU VA4310	20	0.800	6065600

Depending on the tray width, 4–6 cover clamps are required for secure fastening of a 3 m cover.

Cover clamp for universal fastening of covers on cable trays, mesh cable trays and AZ channels.

The cover clamp is not suitable for use with mesh cable trays with a side height of 35 mm.

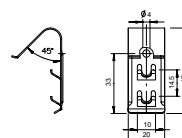

Wall mounting for type GRM 35 x 50

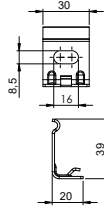

Type	Side height mm	Width mm	Pack. pcs	Weight kg/100 pcs.	Item No.
WH GRM35 FT	35	50	10	1.950	6016443
WH GRM35 VA4401	35	50	10	1.950	6016445

FT Hot-dip galvanised

Wall mounting for wall fastening of mesh cable trays, type GRM 35 50

Wall clamp/central hanger

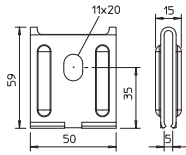
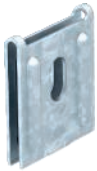

Type	Pack. pcs	Weight kg/100 pcs.	Item No.
K 12 1818 FS	25	7.600	6437109
K12 1818 VA4301	25	7.600	6016421

FS Strip-galvanised

As wall fastening up to max. mesh cable tray width 200 mm.
As centre suspension up to max. mesh cable tray width 200 mm.
As a pendulum suspension from a width of 300 mm.
Wall clamp and central hanger for mesh cable trays.

Mounting plate

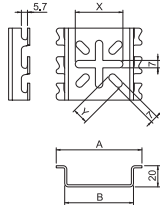

Type	Dimension A mm	Dimension B mm	Dimension x mm	Dimension y mm	Pack. pcs	Weight kg/100 pcs.	Item No.
MPG 65 FT	81	65	45	15	30	9.200	6006486
MPG 90 FT	111	95	45	38	30	16.800	6006487
MPG 65 VA4404	81	65	45	15	30	8.800	6006488
MPG 90 VA4404	111	95	45	38	30	16.100	6006489

FT Hot-dip galvanised

Mounting plate for screwless wall fastening of mesh cable trays.

TP support / wall and support bracket

Type	For width mm	F in kN	Pack. pcs	Weight kg/100 pcs.	Item No.
TPSAG 145 FS	100	1.5	50	33.000	6366015
TPSAG 195 FS	150	1	20	41.000	6366023
TPSAG 245 FS	200	0.9	20	48.000	6366031
TPSAG 345 FS	300	0.55	20	61.000	6366066
TPSAG 145 FT	100	1.5	50	33.000	6366131
TPSAG 195 FT	150	1	20	42.000	6366135
TPSAG 245 FT	200	0.9	20	49.000	6366139
TPSAG 345 FT	300	0.55	20	65.000	6366143
TPSAG 145 VA4301	100	1.5	50	32.000	6366145
TPSAG 195 VA4301	150	1	20	40.000	6366146
TPSAG 245 VA4301	200	0.9	20	47.000	6366148
TPSAG 345 VA4301	300	0.55	20	61.000	6366149

FS Strip-galvanised FT Hot-dip galvanised

If the bracket is fastened directly to the wall or the profiles are screwed together, then, for reasons of stability, always use the spacer, type DS 4.

TP bracket with clamping lugs for screwless mesh cable tray fastening.

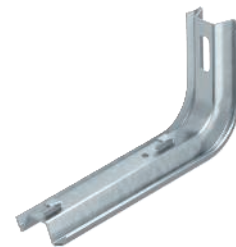

Type	Dimension B mm	Dimension L mm
TPSAG 145 FS	145	50
TPSAG 195 FS	195	100
TPSAG 245 FS	245	150
TPSAG 345 FS	345	250

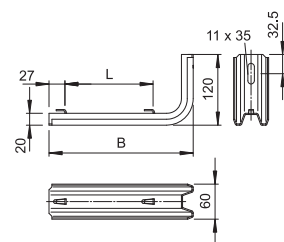

Load diagram, bracket TPSAG

- 1 Bending of the bracket tip at permitted bracket load
- 2 Permitted bracket load in kN without man load
- Load curve with bracket lengths in mm

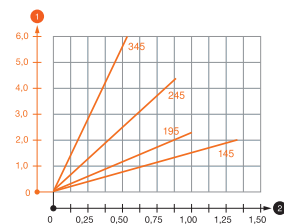

Characteristic anchor load values for TP bracket

Anchor type	Wall fastening			
	Max. load [kN]			
	Bracket width [mm]			
	145	195	245	345
BZ-U 8-30-41/95	1,00	0,80	0,70	0,50
BZ-U 10-30-50/110	1,50	1,00	0,90	0,55

Max. total load F = cable weight + cable tray + bracket. The load capacity values increase considerably when used in uncracked concrete. The values given are based on concrete of strength class C20/25. Observe the installation conditions of the DIBt approval (anchors).

Wall and support bracket MWAG 12



Type	Width F in kN		Pack. pcs	Weight kg/100 pcs.	Item No.
	mm	kN			
MWAG 12 11 FS	110	1.2	30	12.700	6424600
MWAG 12 21 FS	210	1.2	30	24.400	6424608
MWAG 12 31 FS	310	1.2	30	50.300	6424616
MWAG 12 41 FS	410	1.2	25	68.000	6424624

FS Strip-galvanised

Including truss-head bolt M10 x 25 for fastening to U supports.

Light-duty wall and support bracket with edged design for screwless mesh cable tray fastening.

Dimensions

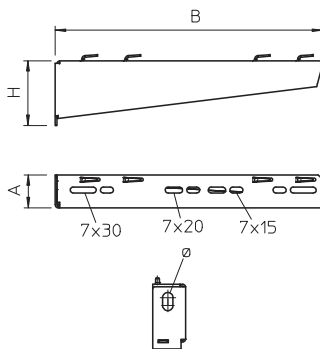

Type	Dimen-	Dimen-	Dimen-	Hole
	sion B	sion A	sion H	Ø
	mm	mm	mm	mm
MWAG 12 11 FS	110	32.5	53	11
MWAG 12 21 FS	210	32.5	65	11
MWAG 12 31 FS	310	38	75	11
MWAG 12 41 FS	410	38	83	11

Load

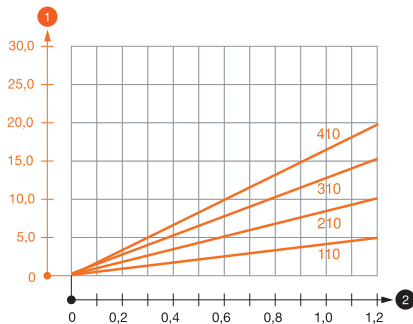

Load diagram, bracket type MWAG 12

① Bending of the bracket tip at permitted bracket load

② Permitted bracket load in kN without man load

— Load curve with bracket lengths in mm

Characteristic anchor load values for wall and support bracket MWAG 12

Anchor type	Max. load [kN]			
	Bracket width [mm]			
	110	210	310	410
BZ-U 8-10-21/75	1,20	0,95	0,70	0,65
BZ-U 10-10-30/90	1,20	1,20	1,20	1,20

Max. total load F = cable weight + cable tray + bracket. The load capacity values increase considerably when used in uncracked concrete. The values given are based on concrete of strength class C20/25. Observe the installation conditions of the DIBt approval (anchors).

Load values for MWAG 12 on suspended support

Support	Max. total load F in kN			
	Bracket length in mm			
	100	200	300	400
US 3 K/ 20-60	1,20	1,20	1,20	1,20
US 3 K/ 70-120	1,20	1,20	1,20	1,20
US 5 K/ 20-60	1,20	1,20	1,20	1,20
US 5 K/ 70-120	1,20	1,20	1,20	1,20

Wall and support bracket AWG 15

Type	Width mm	F in kN kN	Pack. pcs	Weight kg/100 pcs.	Item No.
AW G 15 11 FT	110	1.5	30	14.000	6420606
AW G 15 16 FT	160	1.5	30	20.000	6420607
AW G 15 21 FT	210	1.5	30	26.000	6420608
AW G 15 31 FT	310	1.5	30	35.000	6420610
AW G 15 41 FT	410	1.5	30	56.000	6420612
AW G 15 51 FT	510	1.5	20	69.000	6420614
AW G 15 61 FT	610	1.5	20	84.000	6420616
AWG 15 11 VA4301	110	1.5	30	13.000	6420625
AWG 15 21 VA4301	210	1.5	30	25.000	6420628
AWG 15 31 VA4301	310	1.5	30	33.000	6420631
AWG 15 41 VA4301	410	1.5	30	53.000	6420634
AWG 15 51 VA4301	510	1.5	20	65.000	6420637
AWG 15 61 VA4301	610	1.5	20	80.000	6420640
AWG 15 11 VA4571	110	1.5	30	13.000	6420642
AWG 15 21 VA4571	210	1.5	30	25.000	6420644
AWG 15 31 VA4571	310	1.5	30	33.000	6420646
AWG 15 41 VA4571	410	1.5	30	53.000	6420648
AWG 15 51 VA4571	510	1.5	20	65.000	6420650
AWG 15 61 VA4571	610	1.5	20	80.000	6420652

GB Stained **FT** Hot-dip galvanised

Fastening of the bracket to the U support of width 400 mm or greater using hexagonal bolt through both sides of the support. Please insert suitable spacers.

Light-duty wall and support bracket with welded head plate for screwless mesh cable tray fastening.

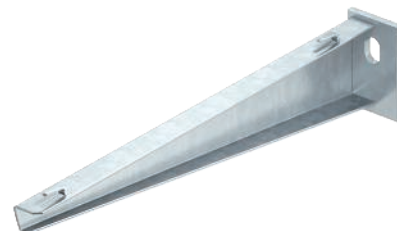

Type	Dimension B mm	Dimension A mm	Dimension H mm	Hole Ø mm
AW G 15 11 FT	110	40	50	11
AW G 15 16 FT	160	40	55	11
AW G 15 21 FT	210	40	60	11
AW G 15 31 FT	310	40	65	11
AW G 15 41 FT	410	40	70	11
AW G 15 51 FT	510	40	75	11
AW G 15 61 FT	610	40	80	11

Dimensions

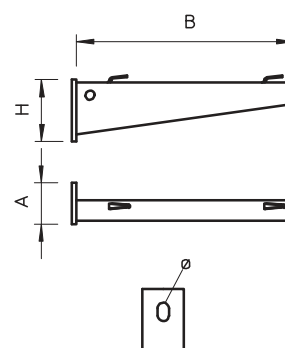

Load diagram, bracket type AW G 15

- 1 Bending of the bracket tip at permitted bracket load
 - 2 Permitted bracket load in kN without man load
- Load curve with bracket lengths in mm

Load

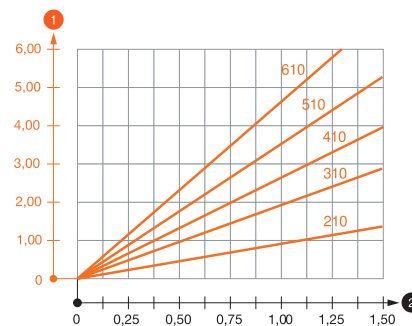

Characteristic anchor load values for wall and support bracket AW G 15

Anchor type	Wall fastening								
	Max. load F [kN]								
	Bracket width [mm]								
BZ-U 8-10-21/75	1.10	0.90	0.80	0.65	0.55	0.50	0.45	0.45	0.45
BZ-U 10-10-30/90	1.50	1.50	1.40	1.10	0.95	0.85	0.80	0.80	0.80

Max. total load F = cable weight + cable tray + bracket. The load capacity values increase considerably when used in uncracked concrete. The values given are based on concrete of strength class C20/25. Observe the installation conditions of the DIBt approval (anchors).

Support	Max. total load F in kN			
	Bracket length in mm			
	100	200	300	400
US 3 K/ 20 - 60	1.50	1.50	1.30	1.30
US 3 K/ 70 - 120	1.50	1.50	1.30	1.30
US 5 K/ 20 - 60	1.50	1.50	1.50	1.50
US 5 K/ 70 - 120	1.50	1.50	1.40	1.50

Threaded rod

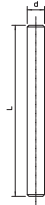

Type	Thread	Dimension d mm	Dimension L mm	Pack. pcs	Weight kg/100 pcs.	Item No.
2078 M6 1M G	M6	6	1000	10	18.300	3141047
2078 M8 1M G	M8	8	1000	10	30.000	3141128
2078 M10 1M G	M10	10	1000	10	49.000	3141209
2078 M12 1M G	M12	12	1000	10	62.000	3141306
2078 M6 2M G	M6	6	2000	10	36.600	3141048
2078 M8 2M G	M8	8	2000	10	60.000	3141136
2078 M10 2M G	M10	10	2000	10	98.000	3141140
2078 M12 2M G	M12	12	2000	10	140.000	3141144
2078 M6 1M V2A	M6	6	1000	10	18.300	3141327
2078 M8 1M V2A	M8	8	1000	10	30.000	3141310
2078 M10 1M V2A	M10	10	1000	10	49.000	3141312
2078 M12 1M V2A	M12	12	1000	10	70.000	3141314
2078 M6 2M V2A	M6	6	2000	10	36.600	3141328
2078 M8 2M V2A	M8	8	2000	10	60.000	3141330
2078 M10 2M V2A	M10	10	2000	10	98.000	3141339
2078 M12 2M V2A	M12	12	2000	10	140.000	3141316
2078 M6 1M V4A	M6	6	1000	50	18.300	3141482
2078 M8 1M V4A	M8	8	1000	50	30.000	3141492
2078 M10 1M V4A	M10	10	1000	25	49.000	3141502
2078 M12 1M V4A	M12	12	1000	20	70.000	3141512
2078 M6 2M V4A	M6	6	2000	25	36.600	3141484
2078 M8 2M V4A	M8	8	2000	25	60.000	3141494
2078 M10 2M V4A	M10	10	2000	20	98.000	3141504
2078 M12 2M V4A	M12	12	2000	10	140.000	3141514

G Electrogalvanised

Threaded rod to DIN 976.

Side holder

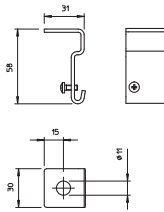

Type	Pack. pcs	Weight kg/100 pcs.	Item No.
SH M10 FS	50	5.800	6015336
SH M10 FT	50	6.000	6015338
SH M10 A4	20	5.500	6015340

FS Strip-galvanised FT Hot-dip galvanised

Side holder for suspension of mesh cable trays.

Side holder, universal

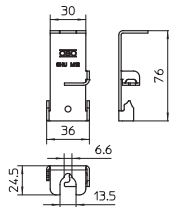

Type	Pack. pcs	Weight kg/100 pcs.	Item No.
SHU M12 FS	50	5.100	6015322
SHU M12 DD	50	5.100	6015324
SHU M12 VA4301	50	5.100	6015326
SHU M12 VA4571	50	5.100	6015328

FS Strip-galvanised DD Strip galvanised zinc/aluminium, double dip

Side holder to fasten cable trays, mesh cable trays and cable ladders to ceilings using a threaded rod.

Centre suspension

Type	Hole Ø mm	Pack. pcs	Weight kg/100 pcs.	Item No.
GMA M6 FS	7	25	8.000	6015220
GMA M8 FS	9	25	8.300	6015239
GMA M10 FS	11	25	8.300	6015247
GMA M6 FT	7	25	8.400	6015224
GMA M8 FT	9	25	8.300	6015243
GMA M10 FT	11	25	8.400	6015255
GMA M6 VA4401	7	25	8.400	6015228
GMA M8 VA4401	9	25	8.300	6015245
GMA M10 VA4401	11	25	8.300	6015261

FS Strip-galvanised FT Hot-dip galvanised

When filling with cables, please ensure an even distribution. The maximum recommended mesh cable tray width is 200 mm.

Two-part centre suspension of mesh cable trays.

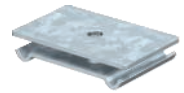
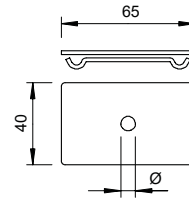

Centre suspension

Type	Dimension B mm	Pack. pcs	Weight kg/100 pcs.	Item No.
GMS 170 FS	170	25	20.000	6015400
GMS 270 FS	270	25	32.000	6015402
GMS 370 FS	370	25	43.000	6015404
GMS 470 FS	470	10	55.000	6015406
GMS 570 FS	570	10	67.000	6015408
GMS 170 VA4404	170	25	20.000	6015418
GMS 270 VA4404	270	25	32.000	6015419
GMS 370 VA4404	370	25	43.000	6015420
GMS 470 VA4404	470	10	55.000	6015421
GMS 570 VA4404	570	10	67.000	6015422

FS Strip-galvanised

Centre suspension including hold-down clamp for mesh cable tray suspensions.

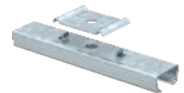
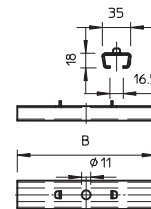

Hold-down clip

Type	Dimension b mm	Version	Pack. pcs	Weight kg/100 pcs.	Item No.
BC GR 4.8 VA	17	For wire thicknesses 3.9 and 4.8 mm	20	1.760	6016665

Hold-down clip for the screwless mounting of mesh cable trays onto MS profile rails.

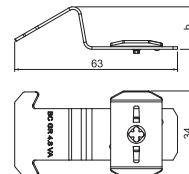

TP wall and ceiling bracket



Type	For width mm	F in kN ceiling	F in kN Wall	Pack. pcs	Weight kg/100 pcs.	Item No.
TPDG 145 FS	100	1.3	1.4	6	53.000	6365906
TPDG 195 FS	150	0.95	1.05	6	91.100	6365914
TPDG 245 FS	200	0.8	0.87	5	68.000	6365922
TPDG 345 FS	300	0.5	0.55	5	81.000	6365949
TPDG 145 FT	100	1.3	1.4	6	56.000	6365977
TPDG 245 FT	200	0.8	0.87	5	71.000	6365981
TPDG 345 FT	300	0.5	0.55	5	86.000	6365985
TPDG 145 VA4301	100	1.3	1.4	6	53.000	6365989
TPDG 195 VA4301	150	0.95	1.05	6	91.100	6365991
TPDG 245 VA4301	200	0.8	0.87	5	67.000	6365993
TPDG 345 VA4301	300	0.5	0.55	5	81.000	6365995

FS Strip-galvanised FT Hot-dip galvanised

If the bracket is fastened directly to the wall or ceiling, then, for reasons of stability, always use the spacer, type DS 4.

Max. side height of the cable support system 60 mm.

TP wall and ceiling bracket with clamping lugs for screwless mesh cable tray fastening.

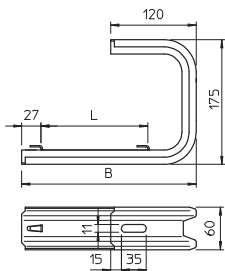

Type	Dimension B mm	Dimension L mm
TPDG 145 FS	145	110
TPDG 195 FS	195	160
TPDG 245 FS	245	210
TPDG 345 FS	345	310

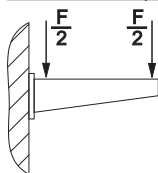

Characteristic anchor load values for TPD wall and ceiling bracket - Wall fastening

Max. load F [kN]	145	245	345	445	545
Bracket length [mm]					
Anchor type					
BZ-U 8-30-41/95	1	0.7	0.5	0.4	0.3
BZ-U 10-30-50/110	1.5	0.9	0.55	0.45	0.35

Max. total load F = cable weight + cable tray + ceiling bracket. The load capacity values increase considerably when used in uncracked concrete. The values given are based on concrete of strength class C20/25.

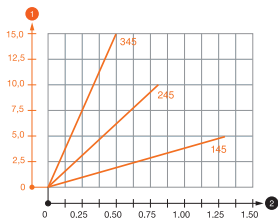

Load diagram, ceiling bracket TPDG

- 1 Bending of the bracket tip at permitted bracket load
- 2 Permitted bracket load in kN without man load
- Load curve with bracket lengths in mm

Characteristic anchor load values for TPDG wall and ceiling bracket

Wall fastening					
Anchor type	Max. load [kN]				
	Bracket length [mm]				
	145	245	345	445	545
BZ-U 8-30-41/95	1.00	0.70	0.50	0.40	0.30
BZ-U 10-30-50/110	1.50	0.90	0.55	0.45	0.35

Ceiling fastening					
Anchor type	Max. load F [kN]				
	Bracket width [mm]				
	145	245	345	445	545
BZ-U 8-30-41/95	1.30	0.80	0.50	0.35	0.25
BZ-U 10-30-50/110	1.30	0.80	0.50	0.35	0.25

Max. total load F = cable weight + cable tray + ceiling bracket. The load capacity values increase considerably when used in uncracked concrete. The values given are based on concrete of strength class C20/25.

TP profile

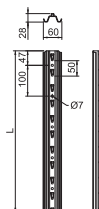

Type	Length mm	Pack. pcs	Weight kg/100 pcs.	Item No.
TPSG 3000 FS	3000	1	401.700	6366090
TPSG 3000 FT	3000	1	461.000	6366093

FS Strip-galvanised FT Hot-dip galvanised

TP profile with clamping lugs.

End cap

Type	Colour	Pack. pcs	Weight kg/100 pcs.	Item No.
TPS KS OR	Pastel orange	10	0.569	6364625

End cap to cover ends of TP supports.

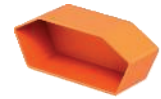
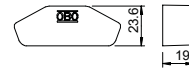

Spacer

Type	Pack. pcs	Weight kg/100 pcs.	Item No.
DS 4 FS	20	3.700	6416551
DS 4 FT	20	3.800	6416586
DS 4 VA4301	10	3.700	6416594

FS Strip-galvanised FT Hot-dip galvanised

For static reasons, the spacer is always used to prevent the profile from deforming when the fastening bolts are tightened.

Spacer for use in profiles, type TP.

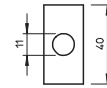

Truss-head bolt

Type	Dimension mm	Resistance class	Pack. pcs	Weight kg/100 pcs.	Item No.
FRS 10x25 TPS F	M 10 x 25	5.6	50	4.300	6407536
FRS 10x25 TPS A2	M10 x 25	A2-70	50	4.000	6407537

F Hot-dip galvanised

Truss-head bolt with square neck. With washer and hexagonal nut.

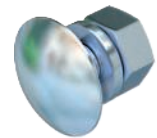
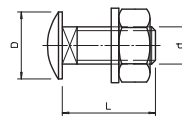

Hexagonal bolt

Type	Dimension mm	Dimension L mm	Dimension d mm	SW mm	Pack. pcs	Weight kg/100 pcs.	Item No.
SKS 10x60 F	M10 x 60	60	10	17	20	6.000	6408516

F Hot-dip galvanised

Hexagonal bolt for universal fixing of structure components.

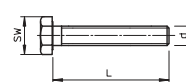

Stand-off bracket

Type	Dimension B mm	Pack. pcs	Weight kg/100 pcs.	Item No.
DBLG 20 050 FS	50	20	10.300	6015646
DBLG 20 100 FS	100	20	13.800	6015654
DBLG 20 150 FS	150	20	17.400	6015658
DBLG 20 200 FS	200	20	20.900	6015662
DBLG 20 300 FS	300	20	37.300	6015670
DBLG 20 400 FS	400	20	46.700	6015689
DBLG 20 500 FS	500	25	56.900	6015693
DBLG 20 600 FS	600	25	66.400	6015697
DBLG 20 050 FT	50	20	10.700	6015648
DBLG 20 100 FT	100	20	14.300	6015656
DBLG 20 150 FT	150	20	18.100	6015660
DBLG 20 200 FT	200	20	21.700	6015664
DBLG 20 300 FT	300	20	38.800	6015672
DBLG 20 400 FT	400	20	48.600	6015691
DBLG 20 500 FT	500	25	59.200	6015695
DBLG 20 600 FT	600	25	69.100	6015699

FS Strip-galvanised FT Hot-dip galvanised

Screwless fastening of the mesh cable tray on the stand-off bracket.

Stand-off bracket for stand-off of mesh cable trays on the floor or on the wall.

GRM mesh cable tray types with side heights of 35, 55 and 105 mm can be mounted onto the spacer clamp.

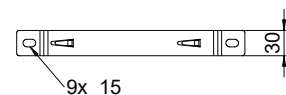
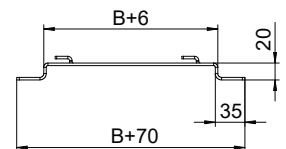
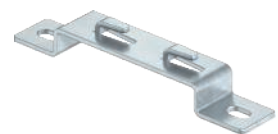

Tray fastening system set 10 kg with TrayFix large

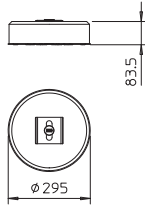

Type	From tray width mm	Pack.	Weight	Item No.
		pcs	kg/100 pcs.	
TrayFix-10-L	100	1	1,100.000	5403101

- Mounting system for the fastening of mesh cable trays with the FangFix stone, e.g. cable routing on a flat roof.
- Matched to OBO cable tray systems MKSM and SKSM.
- Matched to OBO mesh cable systems with a minimum width of 100 mm.
- Set consisting of TrayFix mounting adapter and concrete block including base for FangFix system 16 kg

Tray fastening system set 10 kg with TrayFix small

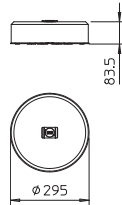

Type	From tray width mm	Pack.	Weight	Item No.
		pcs	kg/100 pcs.	
TrayFix-10-S	100	1	1,000.000	5403102

- Mounting system for the fastening of mesh cable trays with the FangFix stone, e.g. cable routing on a flat roof.
- Matches OBO mesh cable tray systems with a minimum width of 100 mm
- Set consisting of TrayFix mounting adapter and concrete block including base for FangFix system 10 kg

Tray fastening system set 16 kg with TrayFix large

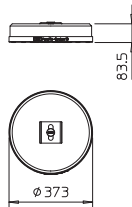

Type	From tray width mm	Pack.	Weight	Item No.
		pcs	kg/100 pcs.	
TrayFix-16-L	100	1	1,700.000	5403098

- Mounting system for the fastening of mesh cable trays with the FangFix stone, e.g. cable routing on a flat roof.
- Matched to OBO cable tray systems MKSM and SKSM.
- Matched to OBO mesh cable systems with a minimum width of 100 mm.
- Set consisting of TrayFix mounting adapter and concrete block including base for FangFix system 16 kg

Tray fastening system set 16 kg with TrayFix small

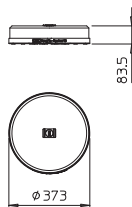

Type	From tray width mm	Pack.	Weight	Item No.
		pcs	kg/100 pcs.	
TrayFix-16-S	100	1	1,700.000	5403099

- Mounting system for the fastening of mesh cable trays with the FangFix stone, e.g. cable routing on a flat roof.
- Matches OBO mesh cable tray systems with a minimum width of 100 mm
- Set consisting of TrayFix mounting adapter and concrete block including base for FangFix system 16 kg

Mesh angle

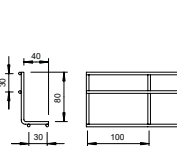
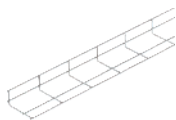

Type	Length mm	Wire Ø mm	Pack.	Weight	Item No.
			m	kg/100 m	
GW 40 80 FT	2000	4.4	50	63.000	6003818

FT Hot-dip galvanised

Mesh angle for routing cables in steel girders.

Magnetic shield insulation without cover 15 dB, with cover 25 dB.

Beam clamp

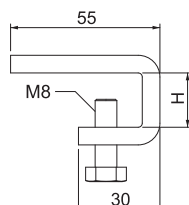
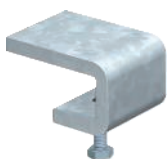

Type	Height mm	Pack.	Weight	Item No.
		pcs	kg/100 pcs.	
KL 20 FT	20	10	22.000	6003850
KL 30 FT	30	10	24.000	6003869

FT Hot-dip galvanised

When selecting the beam clamp, please take the flange thickness of the steel girder into account.

Beam clamp for fastening the mesh bracket, type GW 40 80 to steel girders.

G mesh cable tray Magic, side height 50 mm

Type	Side height mm	Wire Ø mm	Pack. m	Weight kg/100 m	Item No.
G-GRM 50 50 G	50	3.9	3	67.100	6005535
G-GRM 50 50 FT	50	3.9	3	68.600	6005520
G-GRM 50 50V2A	50	3.9	3	67.100	6005550
G-GRM 50 50V4A	50	3.9	3	67.100	6005565

G Electrogalvanised **FT** Hot-dip galvanised

G-shaped mesh cable tray made of spot-welded steel wire with different side heights and widths. Direct wall or ceiling mounting possible. Load capacity details regarding the different mounting methods are available upon request.

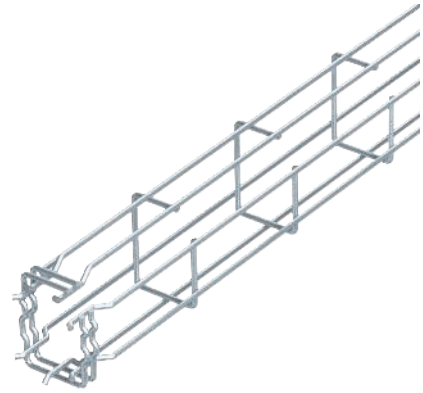

Type	Length mm	Dimension B mm	Dimension H mm	Dimension C mm	Dimension A mm	Wire Ø mm
G-GRM 50 50 G	3000	55	55	33	40	3.9

Dimensions

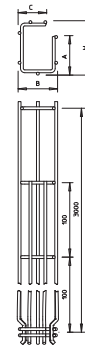

Load

G-GRM 50/50

	Support spacing [m]			
	Load [kN/m]			
Fastening variant	1	1.5	2	2.5
Wall fastening K12 1818	0.2	0.15	0.1	0.05
Ceiling fastening K12 1818	0.25	0.2	0.10	0.05

Hook rail for G mesh cable tray

Type	Length mm	Width mm	Side height mm	Pack. pcs	Weight kg/100 pcs.	Item No.
G-GRM-R50 FS	50	25	15	25	2.300	6005605
G-GRM-R50VA4301	50	25	15	25	2.300	6005635

FS Strip-galvanised

Hook rail for wall mounting of G mesh cable trays



G mesh cable tray Magic, side height 75 mm

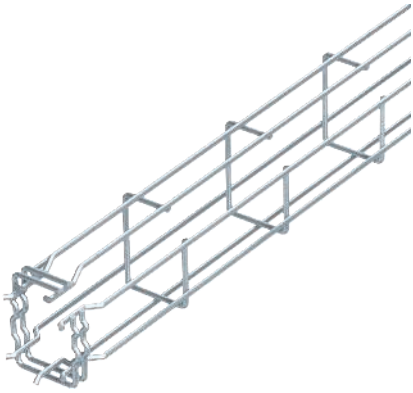

Type	Side height mm	Wire Ø mm	Pack. m	Weight kg/100 m	Item No.
G-GRM 75 50 G	75	3.9	3	79.900	6005538
G-GRM 75 50 FT	75	3.9	3	81.700	6005523
G-GRM 75 50V2A	75	3.9	3	79.900	6005553
G-GRM 75 50V4A	75	3.9	3	79.900	6005568

G Electrogalvanised **FT** Hot-dip galvanised

G-shaped mesh cable tray made of spot-welded steel wire with different side heights and widths. Direct wall or ceiling mounting possible. Load capacity details regarding the different mounting methods are available upon request. Magnetic shield insulation 15 dB.

Dimensions

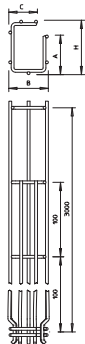

Type	Length mm	Dimension B mm	Dimension H mm	Dimension C mm	Dimension A mm	Wire Ø mm
G-GRM 75 50 G	3000	53	73	40	53	3.9

Load

G-GRM 75/50

	Support spacing [m]			
	Load [kN/m]			
Fastening variant	1	1.5	2	2.5
Wall fastening K12 1818	0.3	0.2	0.15	0.1
Ceiling fastening K12 1818	0.35	0.2	0.15	0.1
Ceiling fastening K12 1818	0.35	0.2	0.15	0.1

Hook rail for G mesh cable tray



Type	Length mm	Width mm	Side height mm	Pack. pcs	Weight kg/100 pcs.	Item No.
G-GRM-R75 FS	55	25	15	25	2.400	6005607
G-GRM-R75VA4301	55	25	15	25	2.400	6005637

FS Strip-galvanised

Hook rail for wall mounting of G mesh cable trays

G mesh cable tray Magic, side height 125 mm

Type	Side height mm	Wire Ø mm	Pack. m	Weight kg/100 m	Item No.
G-GRM 125 75 G	125	3.9	3	108.000	6005541
G-GRM 125 75 FT	125	3.9	3	113.670	6005526
G-GRM 125 75V2A	125	3.9	3	108.000	6005556
G-GRM 125 75V4A	125	3.9	3	108.000	6005571

G Electrogalvanised **FT** Hot-dip galvanised

G-shaped mesh cable tray made of spot-welded steel wire with different side heights and widths. Direct wall or ceiling mounting possible. Load capacity details regarding the different mounting methods are available upon request. Magnetic shield insulation 15 dB.

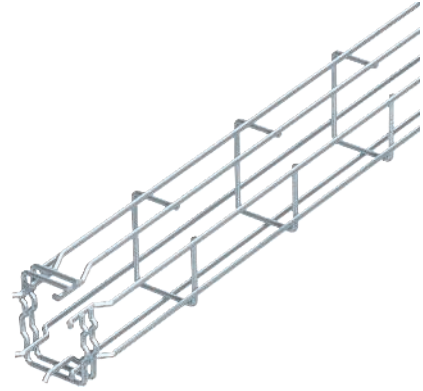

Type	Length mm	Dimension B mm	Dimension H mm	Dimension C mm	Dimension A mm	Wire Ø mm
G-GRM 125 75 G	3000	75	125	40	96	3.9

Dimensions

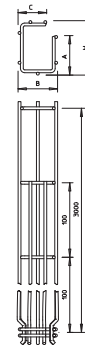

Load

G-GRM 125/75

	Support spacing [m]			
	Load [kN/m]			
Fastening variant	1	1.5	2	2.5
Bracket MWAG 12-11	0.6	0.35	0.3	0.2
Wall fastening K12 1818	0.25	0.25	0.2	0.15
Ceiling fastening K12 1818	0.3	0.25	0.2	0.15

Hook rail for G mesh cable tray

Type	Length mm	Width mm	Side height mm	Pack. pcs	Weight kg/100 pcs	Item No.
G-GRM-R125 FS	105	25	15	25	4.600	6005612
G-GRM-R125VA4301	105	25	15	25	4.600	6005642

FS Strip-galvanised

Hook rail for wall mounting of G mesh cable trays



G mesh cable tray Magic, side height 150 mm

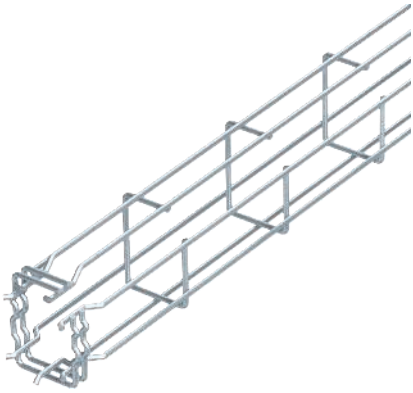

Type	Side height mm	Wire Ø mm	Pack. m	Weight kg/100 m	Item No.
G-GRM 150 100 G	150	3.9	3	128.000	6005544
G-GRM 150 100 FT	150	3.9	3	130.900	6005529
G-GRM 150 100V2A	150	3.9	3	128.000	6005559
G-GRM 150 100V4A	150	3.9	3	128.000	6005574

G Electrogalvanised **FT** Hot-dip galvanised

G-shaped mesh cable tray made of spot-welded steel wire with different side heights and widths. Direct wall or ceiling mounting possible. Load capacity details regarding the different mounting methods are available upon request. Magnetic shield insulation 15 dB.

Dimensions

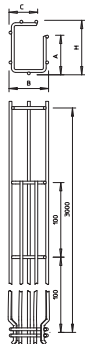

Type	Length mm	Dimen- sion B mm	Dimen- sion H mm	Dimen- sion C mm	Dimen- sion A mm	Wire Ø mm
G-GRM 150 100 G	3000	100	155	70	120	3.9

Load

G-GRM 150/100

	Support spacing [m]			
	Load [kN/m]			
Fastening variant	1	1.5	2	2.5
Bracket MWAG 12-11	0.6	0.5	0.35	0.3
Wall fastening K12 1818	0.25	0.2	0.15	0.1
Ceiling fastening K12 1818	0.25	0.25	0.15	0.1

Hook rail for G mesh cable tray



Type	Length mm	Width mm	Side height mm	Pack. pcs	Weight kg/100 pcs.	Item No.
G-GRM-R150 FS	110	25	15	25	4.800	6005615
G-GRM-R150VA4301	110	25	15	25	4.800	6005645

FS Strip-galvanised

Hook rail for wall mounting of G mesh cable trays

C mesh cable tray CGR

Type	Side height mm	Wire Ø mm	Pack. m	Weight kg/100 m	Item No.
CGR 50 50 FT	50	4.5	3	128.670	6017428
CGR 50 100 FT	50	4.5	3	136.667	6017436
CGR 50 200 FT	50	4.5	3	173.340	6017444
CGR 50 300 FT	50	4.5	3	204.340	6017452
CGR 50 400 FT	50	4.5	3	240.000	6017460
CGR 50 50 VA4301	50	4.5	3	124.670	6016200
CGR 50 100VA4301	50	4.5	3	131.667	6016235
CGR 50 200VA4301	50	4.5	3	169.000	6016251
CGR 50 300VA4301	50	4.5	3	195.340	6016253
CGR 50 400VA4301	50	4.5	3	222.334	6016255

GB Stained FT Hot-dip galvanized

C-shaped mesh cable tray made of spot-welded steel wire of side height 50 mm.

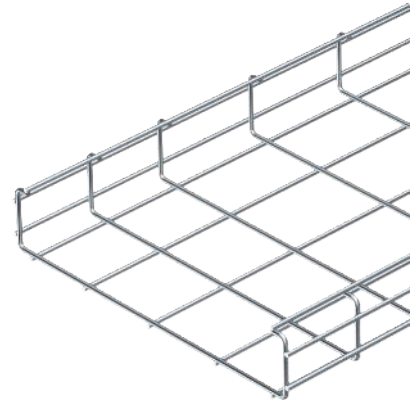

Dimensions

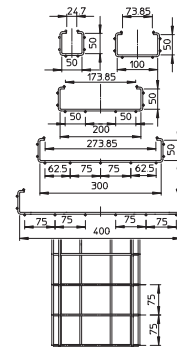

Type	Length mm	Width mm	Wire Ø mm	Useful cross-section cm ²
CGR 50 50 FT	3000	50	4.5	13
CGR 50 100 FT	3000	100	4.5	34
CGR 50 200 FT	3000	200	4.5	75
CGR 50 300 FT	3000	300	4.5	116
CGR 50 400 FT	3000	400	4.5	157

Type	1.0 m kN/m	1.5 m kN/m	2.0 m kN/m
CGR 50 50 FT	0.95	0.6	0.35
CGR 50 100 FT	0.95	0.6	0.35
CGR 50 200 FT	1.1	0.7	0.4
CGR 50 300 FT	1.1	0.7	0.4
CGR 50 400 FT	1.1	0.7	0.4

Load diagram, C mesh cable tray, type CGR 50

- 1 Permitted cable tray/ladder load in kN/m without man load
- 2 Support width in m
- 3 Rail bend in mm at permitted kN/m
- 4 Load scheme during testing
- Load curve with cable tray/ladder width in mm
- Strut bend curve according to support width

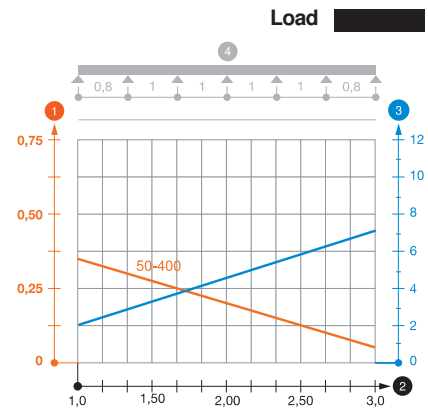

Barrier strip

Type	Dimen- sion H mm	Plate thickness mm	Dimen- sion L mm	Pack. m	Weight kg/100 m	Item No.
TSG 30 DD	30	0.75	3000	3	38.000	6062314
TSG 30 VA4301	30	0.75	3000	3	37.670	6062052

DD Strip galvanized zinc/aluminium, double dip

Barrier strip for separation of cables of different voltages or functions.

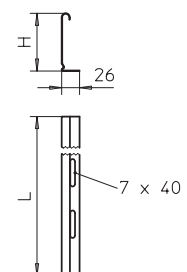
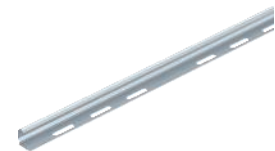

Barrier strip connector

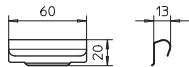

Type	Pack. Weight		Item No.
	pcs	kg/100 pcs.	
TSGV VA4310	10	0.923	6067970

Barrier strip connector for screwless connection of the TSG barrier strip in all side heights.

Hold-down clamp for barrier strip fastening

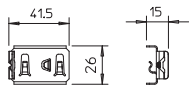

Type	Pack. Weight		Item No.
	pcs	kg/100 pcs.	
KS GR VA4310	30	0.830	6062282

Hold-down clamp for fastening barrier strips in mesh cable trays.

Hold-down clamp for barrier strip fastening

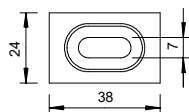
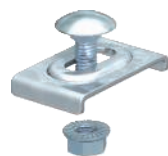

Type	Pack. Weight		Item No.
	pcs	kg/100 pcs.	
GKT 38 FT	20	2.400	6017061
GKT 38 VA4301	20	2.200	6017045

FT Hot-dip galvanised

Including FRS M6 x 20 bolt with flange nut.

Clamp for fastening barrier strip in mesh cable trays.

Joint connector

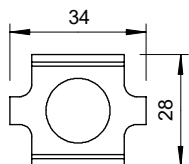
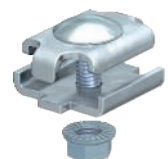

Type	Pack. Weight		Item No.
	pcs	kg/100 pcs.	
GSV 34 FT	20	3.000	6016634
GSV 34 VA4301	20	3.000	6016642

FT Hot-dip galvanised

Including FRS M6 x 20 bolt with flange nut.

Screwed version of joint connector for mesh cable trays.

Figure: Positioning and quantity of mesh cable tray connectors.

50–150 mm = 2 units

200–300 mm = 3 units

400–450 mm = 4 units

500–600 mm = 5 units

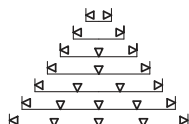

45° mounting angle

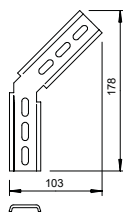

Type	Pack. Weight		Item No.
	pcs	kg/100 pcs.	
MW 45 SL10 FT	20	21.000	6017320
MW 45 SL10VA4301	20	20.000	6017339

FT Hot-dip galvanised

Each with two clamps of type KS 23 35.

45° installation profile, vertical, for C mesh cable tray and GR-Magic® mesh cable tray with a side height of 55 mm.

90° mounting angle

Type	Pack. pcs	Weight kg/100 pcs.	Item No.
MW 90 SL17 FT	20	27.000	6017347
MW 90 SL23 FT	20	35.400	6017355
MW 90 SL17VA4301	20	27.000	6016278
MW 90 SL23VA4301	20	34.700	6016308

FT Hot-dip galvanised

Each with two clamps of type KS 23/35.

90° installation profile, vertical, for C mesh cable tray and GR-Magic® mesh cable tray with a side height of 55 mm.

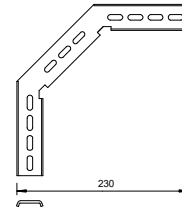

Hold-down clamp

Type	Pack. pcs	Weight kg/100 pcs.	Item No.
KS 23 35 FT	100	2.015	6015174
KS 23 35 VA4301	20	2.015	6016529

FT Hot-dip galvanised

Including M6 locknut.

Clamp for mounting bracket, type MW 45 and MW 90.

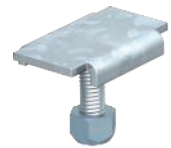
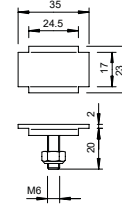

Hold-down clamp

Type	Pack. pcs	Weight kg/100 pcs.	Item No.
GKS 34 FT	20	2.000	6016820
GKS 34 VA4301	20	2.000	6016839

FT Hot-dip galvanised

Including FRS M6 x 20 bolt with flange nut.

Clamp for fixing mesh cable trays to wall or support brackets.

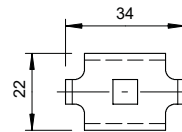

Hook screw

Type	Thread	Pack. pcs	Weight kg/100 pcs.	Item No.
HS M6x13 A2	M6	100	0.500	1154990

Hook screw for fastening cable tracks on the bracket.

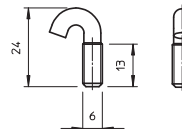

Flange nut

Type	Dimension d mm	Dimension h mm	SW mm	Resistance class	Pack. pcs	Weight kg/100 pcs.	Item No.
KM M6 A2	6	6	10	A2-70	100	0.315	6408966

Nut with pressed washer.

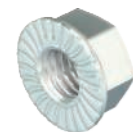
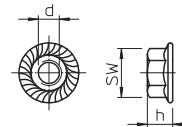

Side height 55 mm

Heavy-duty mesh cable tray SGR

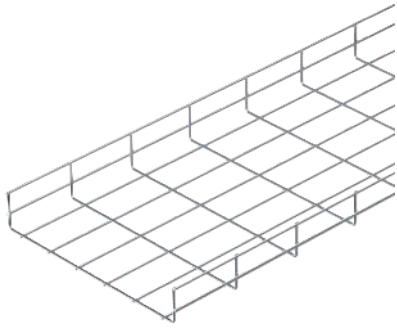

Type	Wire		Pack. m	Weight kg/100 m	Item No.
	Width mm	Ø mm			
SGR 55 100 G	100	6	3	166.340	6005470
SGR 55 150 G	150	6	3	199.000	6005472
SGR 55 200 G	200	6	3	230.070	6005474
SGR 55 300 G	300	6	3	293.240	6005476
SGR 55 400 G	400	6	3	357.034	6005478
SGR 55 500 G	500	6	3	426.340	6005480
SGR 55 600 G	600	6	3	491.670	6005482

G Electrogalvanised

Mesh cable tray made of spot-welded steel wire of side height 55 mm.

The grid width is 50 x 100 mm.

Stainless steel version on request.

Dimensions

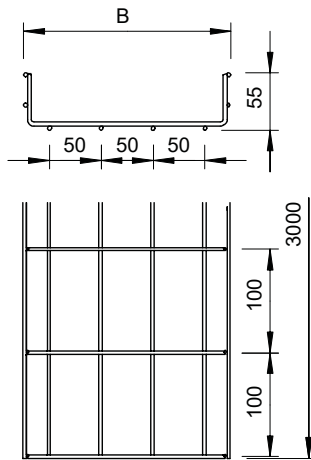

Type	Length mm	Dimen- sion B mm	Wire Ø mm	Useful cross-section cm ²
SGR 55 100 G	3000	100	6	40
SGR 55 150 G	3000	150	6	63
SGR 55 200 G	3000	200	6	87
SGR 55 300 G	3000	300	6	129
SGR 55 400 G	3000	400	6	175
SGR 55 500 G	3000	500	6	220
SGR 55 600 G	3000	600	6	265

Load

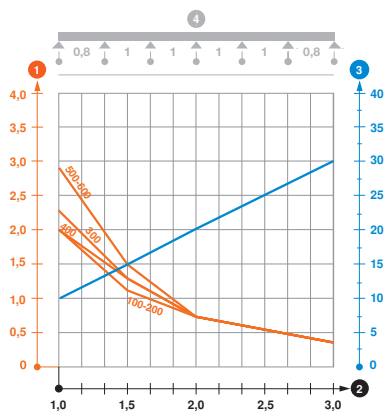

Type	1.0 m kN/m	1.5 m kN/m	2.0 m kN/m	3.0 m kN/m
SGR 55 100 G	2	1.15	0.75	0.4
SGR 55 150 G	2	1.15	0.75	0.4
SGR 55 200 G	2	1.15	0.75	0.4
SGR 55 300 G	2	1.3	0.75	0.4
SGR 55 400 G	2.3	1.3	0.75	0.4
SGR 55 500 G	2.9	1.5	0.75	0.4
SGR 55 600 G	2.9	1.5	0.75	0.4

Load diagram, mesh cable tray, type SGR 55

- 1 Permitted cable tray/ladder load in kN/m without man load
- 2 Support width in m
- 3 Rail bend in mm at permitted kN/m
- 4 Load scheme during testing
- Load curve with cable tray/ladder width in mm
- Strut bend curve according to support width

Heavy-duty mesh cable tray SGR

Type	Wire		Pack. m	Weight kg/100 m	Item No.
	Width mm	Ø mm			
SGR 55 100 FT	100	6	24	171.667	6000122
SGR 55 150 FT	150	6	18	205.334	6000190
SGR 55 200 FT	200	6	18	238.670	6000209
SGR 55 300 FT	300	6	12	305.670	6000331
SGR 55 400 FT	400	6	12	372.700	6000451
SGR 55 500 FT	500	6	12	439.670	6000515
SGR 55 600 FT	600	6	12	507.000	6000775

FT Hot-dip galvanized

Mesh cable tray made of spot-welded steel wire of side height 55 mm. The grid width is 50 x 100 mm.

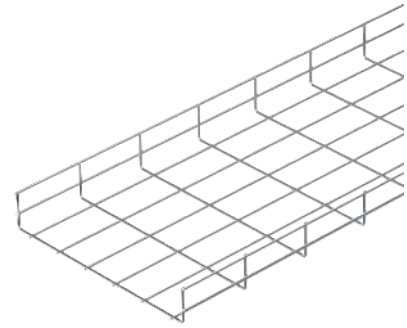

Type	Length mm	Dimension B mm	Wire Ø mm	Useful cross-section cm ²
SGR 55 100 FT	3000	100	6	40
SGR 55 150 FT	3000	150	6	63
SGR 55 200 FT	3000	200	6	87
SGR 55 300 FT	3000	300	6	129
SGR 55 400 FT	3000	400	6	175
SGR 55 500 FT	3000	500	6	220
SGR 55 600 FT	3000	600	6	265

Dimensions

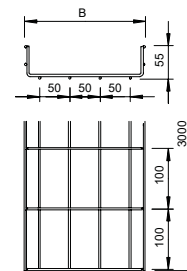

Load

Type	1.0 m kN/m	1.5 m kN/m	2.0 m kN/m	3.0 m kN/m
SGR 55 100 FT	2	1.15	0.75	0.4
SGR 55 150 FT	2	1.15	0.75	0.4
SGR 55 200 FT	2	1.15	0.75	0.4
SGR 55 300 FT	2	1.3	0.75	0.4
SGR 55 400 FT	2.3	1.3	0.75	0.4
SGR 55 500 FT	2.9	1.5	0.75	0.4
SGR 55 600 FT	2.9	1.5	0.75	0.4

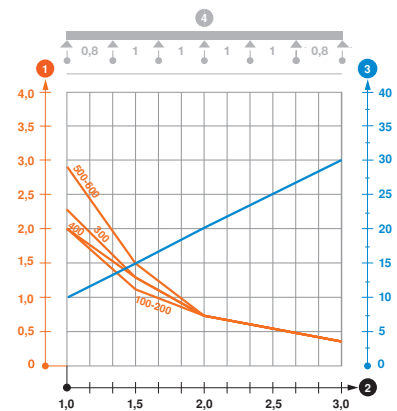

Load diagram, mesh cable tray, type SGR 55

- 1 Permitted cable tray/ladder load in kN/m without man load
- 2 Support width in m
- 3 Rail bend in mm at permitted kN/m
- 4 Load scheme during testing
- Load curve with cable tray/ladder width in mm
- Strut bend curve according to support width

Side height 55 mm

Heavy-duty mesh cable tray SGR

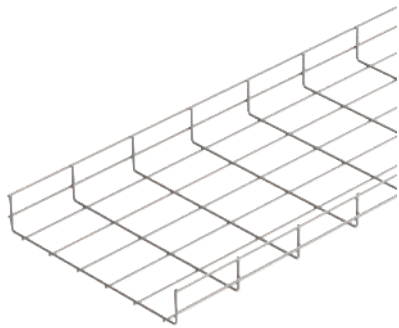

Type	Wire		Pack. m	Weight kg/100 m	Item No.
	Width mm	Ø mm			
SGR 55 100 A2	100	6	3	166.340	6000909
SGR 55 150 A2	150	6	3	198.000	6000913
SGR 55 200 A2	200	6	3	231.340	6000917
SGR 55 300 A2	300	6	3	296.340	6000925
SGR 55 400 A2	400	6	3	361.340	6000933
SGR 55 500 A2	500	6	3	426.340	6000941
SGR 55 600 A2	600	6	3	491.670	6000958

Mesh cable tray made of spot-welded steel wire of side height 55 mm. The grid width is 50 x 100 mm.

Dimensions

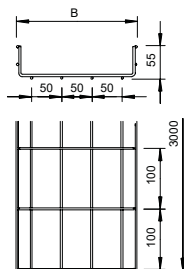

Type	Length mm	Dimension B mm	Wire Ø mm	Useful cross-section cm ²
SGR 55 100 A2	3000	100	6	40
SGR 55 150 A2	3000	150	6	63
SGR 55 200 A2	3000	200	6	87
SGR 55 300 A2	3000	300	6	129
SGR 55 400 A2	3000	400	6	175
SGR 55 500 A2	3000	500	6	220
SGR 55 600 A2	3000	600	6	265

Load

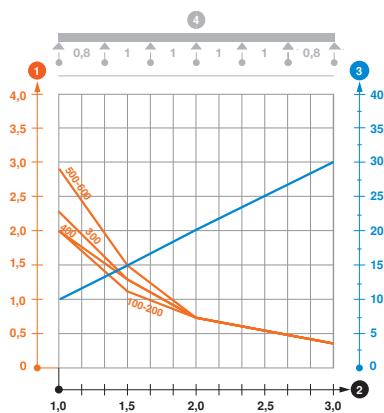

Type	1.0 m kN/m	1.5 m kN/m	2.0 m kN/m	3.0 m kN/m
SGR 55 100 A2	2	1.15	0.75	0.4
SGR 55 150 A2	2	1.15	0.75	0.4
SGR 55 200 A2	2	1.15	0.75	0.4
SGR 55 300 A2	2	1.3	0.75	0.4
SGR 55 400 A2	2.3	1.3	0.75	0.4
SGR 55 500 A2	2.9	1.5	0.75	0.4
SGR 55 600 A2	2.9	1.5	0.75	0.4

Load diagram, mesh cable tray, type SGR 55

- ① Permitted cable tray/ladder load in kN/m without man load
- ② Support width in m
- ③ Rail bend in mm at permitted kN/m
- ④ Load scheme during testing
- Load curve with cable tray/ladder width in mm
- Strut bend curve according to support width

Barrier strip

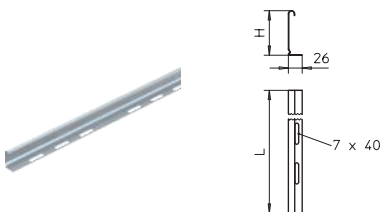

Type	Dimension H mm	Plate thickness mm	Dimension L mm	Pack. m	Weight kg/100 m	Item No.
TSG 45 FS	45	0.75	3000	3	46.700	6062033
TSG 45 DD	45	0.75	3000	3	46.800	6062321

FS Strip-galvanised DD Strip galvanised zinc/aluminium, double dip
Barrier strip for separation of cables of different voltages or functions.

Connector

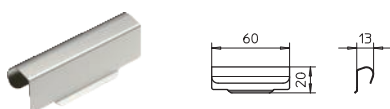

Type	Pack. pcs	Weight kg/100 pcs.	Item No.
TSGV VA4310	10	0.923	6067970

Barrier strip connector for screwless connection of the TSG barrier strip in all side heights.

Hold-down clamp

Type

GKT 38 G

G Electrogalvanised

Including FRS M6 x 20 bolt with flange nut.

Clamp for fastening barrier strip in mesh cable trays.

Pack. pcs	Weight kg/100 pcs.	Item No.
20	2.300	6017037

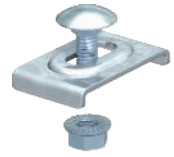
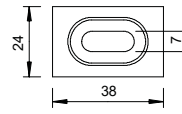

Heavy-duty mesh cable tray SGR

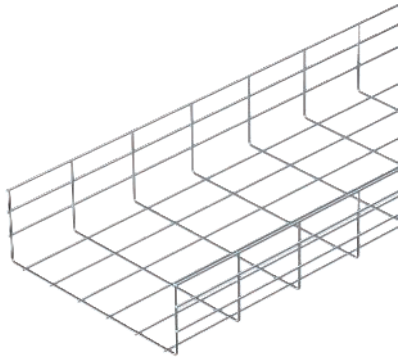

Type	Wire		Pack. m	Weight kg/100 m	Item No.
	Width mm	Ø mm			
SGR 105 150 FT	150	6	3	272.340	6003175
SGR 105 200 FT	200	6	3	305.700	6003214
SGR 105 300 FT	300	6	3	372.670	6003309
SGR 105 400 FT	400	6	3	439.670	6003402
SGR 105 500 FT	500	6	3	507.000	6003515
SGR 105 600 FT	600	6	3	574.700	6003616

FT Hot-dip galvanized

Mesh cable tray made of spot-welded steel wire of side height 105 mm. The grid width is 50 x 100 mm.

Dimensions

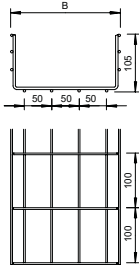

Type	Length mm	Dimension B mm	Wire Ø mm	Useful cross-section cm ²
SGR 105 150 FT	3000	150	6	130
SGR 105 200 FT	3000	200	6	175
SGR 105 300 FT	3000	300	6	268
SGR 105 400 FT	3000	400	6	363
SGR 105 500 FT	3000	500	6	459
SGR 105 600 FT	3000	600	6	554

Load

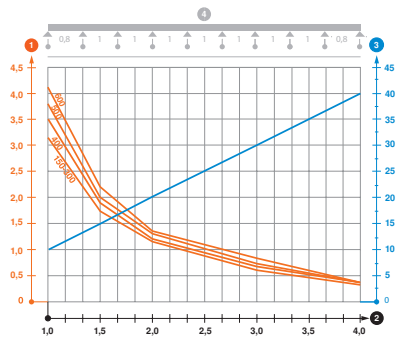

Type	1.0 m kN/m	1.5 m kN/m	2.0 m kN/m	3.0 m kN/m	4.0 m kN/m
SGR 105 150 FT	3.1	1.75	1.15	0.6	0.4
SGR 105 200 FT	3.1	1.75	1.15	0.6	0.4
SGR 105 300 FT	3.1	1.75	1.15	0.6	0.4
SGR 105 400 FT	3.5	1.9	1.2	0.7	0.45
SGR 105 500 FT	3.8	2	1.3	0.75	0.45
SGR 105 600 FT	4.1	2.2	1.35	0.8	0.45

Load diagram, mesh cable tray, type SGR 105

- 1 Permitted cable tray/ladder load in kN/m without man load
- 2 Support width in m
- 3 Rail bend in mm at permitted kN/m
- 4 Load scheme during testing
- Load curve with cable tray/ladder width in mm
- Strut bend curve according to support width

Heavy-duty mesh cable tray SGR

Type	Wire		Pack. m	Weight kg/100 m	Item No.
	Width mm	Ø mm			
SGR 105 150 A2	150	6	3	264.000	6003623
SGR 105 200 A2	200	6	3	296.340	6003625
SGR 105 300 A2	300	6	3	361.340	6003627
SGR 105 400 A2	400	6	3	426.340	6003629
SGR 105 500 A2	500	6	3	491.670	6003631
SGR 105 600 A2	600	6	3	557.340	6003633

Mesh cable tray made of spot-welded steel wire of side height 105 mm. The grid width is 50 x 100 mm.

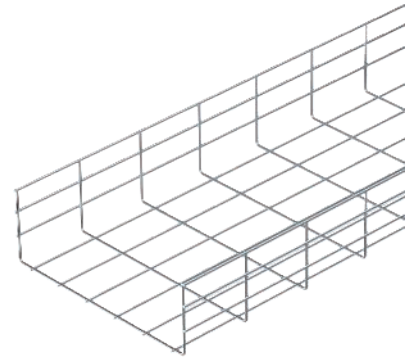

Type	Length mm	Dimen- sion B mm	Wire Ø mm	Useful cross-section cm²
SGR 105 200 A2	3000	200	6	175
SGR 105 300 A2	3000	300	6	268
SGR 105 400 A2	3000	400	6	363
SGR 105 500 A2	3000	500	6	459
SGR 105 600 A2	3000	600	6	554

Dimensions

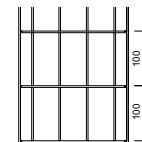
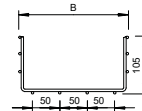

Load

Type	1.0 m	1.5 m	2.0 m	3.0 m	4.0 m
	kN/m	kN/m	kN/m	kN/m	kN/m
SGR 105 150 A2	3.1	1.75	1.15	0.6	0.4
SGR 105 200 A2	3.1	1.75	1.15	0.6	0.4
SGR 105 300 A2	3.1	1.75	1.15	0.6	0.4
SGR 105 400 A2	3.5	1.9	1.2	0.7	0.45
SGR 105 500 A2	3.8	2	1.3	0.75	0.45
SGR 105 600 A2	4.1	2.2	1.35	0.8	0.45

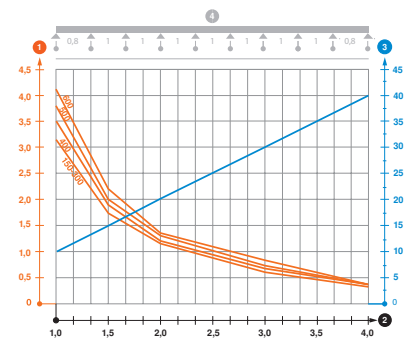

Load diagram, mesh cable tray, type SGR 105

- 1 Permitted cable tray/ladder load in kN/m without man load
- 2 Support width in m
- 3 Rail bend in mm at permitted kN/m
- 4 Load scheme during testing
- Load curve with cable tray/ladder width in mm
- Strut bend curve according to support width

Type	Dimen- sion H mm	Plate thickness mm	Dimen- sion L mm	Pack. m	Weight kg/100 m	Item No.
TSG 85 DD	85	0.75	3000	3	70.300	6062331

FS Strip-galvanised DD Strip galvanised zinc/aluminium, double dip
Barrier strip for separation of cables of different voltages or functions.

Barrier strip

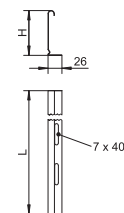

Connector

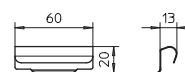

Type	Pack. pcs	Weight kg/100 pcs	Item No.

Barrier strip connector for screwless connection of the TSG barrier strip in all side heights.

Side height 105 mm

Hold-down clamp

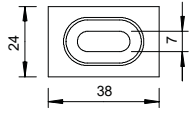
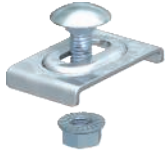

Type

GKT 38 G

G Electrogalvanised

Including FRS M6 x 20 bolt with flange nut.

Clamp for fastening barrier strip in mesh cable trays.

Pack. pcs	Weight kg/100 pcs.	Item No.
20	2.300	6017037

Heavy-duty mesh cable tray SGR

Type	Wire		Pack. m	Weight		Item No.
	Width mm	Ø mm		m	kg/100 m	
SGR 155 300 G	300	6	3	426.334	6003681	
SGR 155 450 G	450	6	3	524.670	6003684	
SGR 155 500 G	500	6	3	557.340	6003685	
SGR 155 600 G	600	6	3	622.340	6003687	

G Electrogalvanised

Mesh cable tray made of spot-welded steel wire of side height 155 mm. The grid width is 50 x 100 mm.

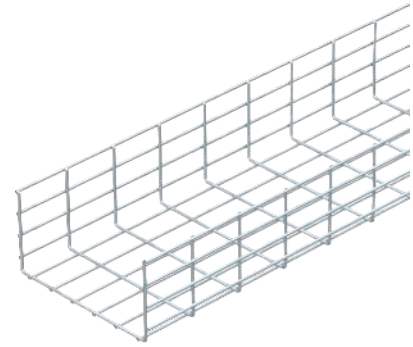

Type	Length mm	Dimen- sion B mm	Wire Ø mm	Useful cross-section cm ²
SGR 155 450 G	3000	450	6	663
SGR 155 500 G	3000	500	6	738
SGR 155 600 G	3000	600	6	888

Dimensions

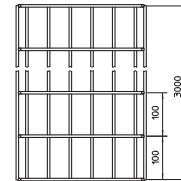
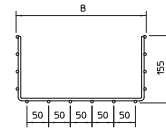

Load

Type	1.0 m	1.5 m	2.0 m	3.0 m	4.0 m
	kN/m	kN/m	kN/m	kN/m	kN/m
SGR 155 300 G	4.1	2.4	1.55	0.95	0.6
SGR 155 450 G	4.1	2.5	1.6	0.95	0.6
SGR 155 500 G	4.5	2.6	1.6	1	0.65
SGR 155 600 G	4.9	3.2	2.2	1.25	0.8

Load diagram, mesh cable tray, type SGR 155

- 1** Permitted cable tray/ladder load in kN/m without man load
- 2** Support width in m
- 3** Rail bend in mm at permitted kN/m
- 4** Load scheme during testing
- Load curve with cable tray/ladder width in mm
- Strut bend curve according to support width

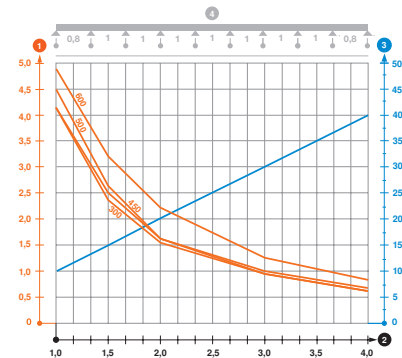

Side height 155 mm

Heavy-duty mesh cable tray SGR

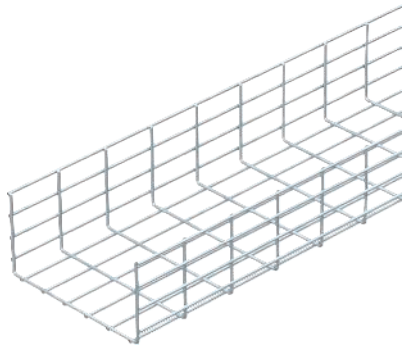

Type	Wire		Pack. m	Weight kg/100 m	Item No.
	Width mm	Ø mm			
SGR 155 300 FT	300	6	3	439.667	6003692
SGR 155 450 FT	450	6	3	541.000	6003695
SGR 155 500 FT	500	6	3	574.670	6003696
SGR 155 600 FT	600	6	3	641.660	6003698

FT Hot-dip galvanised

Mesh cable tray made of spot-welded steel wire of side height 155 mm. The grid width is 50 x 100 mm.

Dimensions

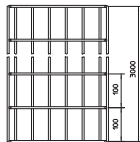
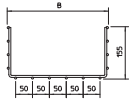

Type	Length mm	Dimension B mm	Wire Ø mm	Useful cross-section cm ²
SGR 155 300 FT	3000	300	6	438
SGR 155 450 FT	3000	450	6	663
SGR 155 500 FT	3000	500	6	738
SGR 155 600 FT	3000	600	6	888

Load

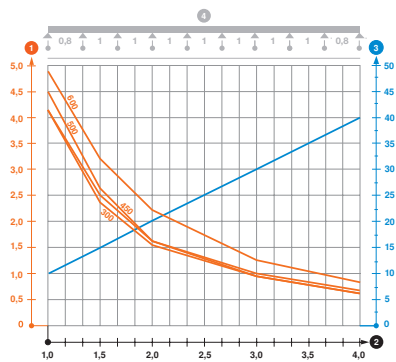

Type	1.0 m kN/m	1.5 m kN/m	2.0 m kN/m	3.0 m kN/m	4.0 m kN/m
SGR 155 300 FT	4.1	2.4	1.55	0.95	0.6
SGR 155 450 FT	4.1	2.5	1.6	0.95	0.6
SGR 155 500 FT	4.5	2.6	1.6	1	0.65
SGR 155 600 FT	4.9	3.2	2.2	1.25	0.8

Load diagram, mesh cable tray, type SGR 155

- ① Permitted cable tray/ladder load in kN/m without man load
- ② Support width in m
- ③ Rail bend in mm at permitted kN/m
- ④ Load scheme during testing
- Load curve with cable tray/ladder width in mm
- Strut bend curve according to support width

Barrier strip

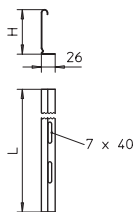

Type	Dimension H mm	Plate thickness mm	Dimension L mm	Pack. m	Weight kg/100 m	Item No.
TSG 135 FS	135	0.75	3000	3	100.000	6062132

FS Strip-galvanised

Barrier strip for separation of cables of different voltages or functions.

Connector



Type	Pack. pcs	Weight kg/100 pcs	Item No.
TSGV VA4310	10	0.923	6067970

Barrier strip connector for screwless connection of the TSG barrier strip in all side heights.

Hold-down clamp

Type

GKT 38 G

G Electrogalvanised

Including FRS M6 x 20 bolt with flange nut.

Clamp for fastening barrier strip in mesh cable trays.

Pack.	Weight	Item No.
pcs	kg/100 pcs.	
20	2.300	6017037

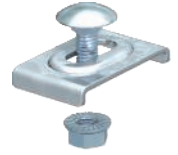
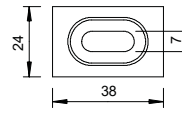

U connector

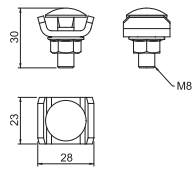

Type

Type	Pack. pcs	Weight kg/100 pcs.	Item No.
GUV 6 G	20	4.154	6016572
GUV 6 FT	20	4.226	6016573
GUV 6 A2	20	4.154	6016574

G Electrogalvanised **FT** Hot-dip galvanised

Including FRS M6 x 20 bolt with flange nut.

Joint connector for mesh cable tray type SGR.

Figure: Positioning and quantity of mesh cable tray connectors.

50–150 mm = 2 units

200–300 mm = 3 units

400–450 mm = 4 units

500–600 mm = 5 units

Corner connector

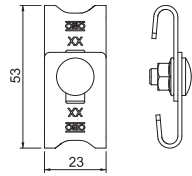

Type

Type	Pack. pcs	Weight kg/100 pcs.	Item No.
GEV 36 G	20	3.040	6016715
GEV 36 FT	20	3.000	6016723
GEV 36 VA4301	20	3.000	6016731
GEV 36 VA4401	10	3.000	6016764

G Electrogalvanised **FT** Hot-dip galvanised

Including FRS M6 x 12 bolt with flange nut

Corner connector for the creation of mesh cable tray bend elements.

Hook screw

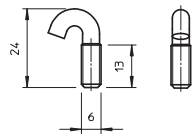

Type

Type	Thread	Pack. pcs	Weight kg/100 pcs.	Item No.
HS M6x13 A2	M6	100	0.500	1154990

Hook screw for fastening cable tracks on the bracket.

Flange nut

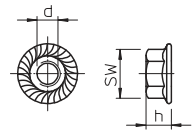

Type

Type	Dimension d mm	Dimension h mm	SW mm	Resistance class	Pack. pcs	Weight kg/100 pcs.	Item No.
KM M6 A2	6	6	10	A2-70	100	0.315	6408966

Nut with pressed washer.

Hold-down clip

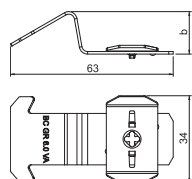

Type

Type	Dimension b mm	Version	Pack. pcs	Weight kg/100 pcs.	Item No.
BC SGR A2	19	For wire Ø 6.0 mm	20	1.760	6016668

Hold-down clip for the screwless mounting of mesh cable trays onto MS profile rails.

End cap

Type	Colour	Pack. pcs	Weight kg/100 pcs.	Item No.
SGR KS OR	Pure orange	500	0.036	6003758

End cap to cover cut wire ends of mesh cable trays.

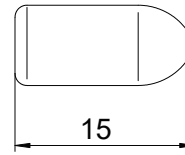

Bolt cutter

Type	Length mm	Pack. pcs	Weight kg/100 pcs.	Item No.
GR BS	450	1	160.000	6017700

Bolt cutter for cutting mesh cable trays.



OBO Bettermann Holding GmbH & Co. KG
P.O. Box 1120
58694 Menden
GERMANY

Customer Service Germany
Tel.: +49 (0)2373 89-1700
Fax.: +49 (0)2373 89-1238
export@obo.de

www.obo-bettermann.com

Building Connections

