



**WAP-6121**  
**N300 PoE Wireless Access Point, Ceiling Mount,**  
**Controller Managed**

**User's Manual**

V1.0\_20161110

# Attention:

## 1. Check box contents:

Ceiling Wireless AP

LAN cable

QIG

Setting Screws

## 2. Warning:



**Attention**

- Do not use the product in high humidity or high temperatures.
- Do not use the same power source for the Product as other equipment. Only use the power adapter that comes with the package. Using a different voltage rating power adapter may damage the device.
- Do not open or repair the case yourself. If the Product is too hot, turn off the power immediately and have it repaired at a qualified service center.
- Place the Product on a stable surface and avoid using this product and all accessories outdoors.

# Contents

Chapter 1 Hardware and Operation mode Instruction.....	4
1.1 LED indicator:.....	4
1.2 AP Interface: .....	4
1.3 Power Supply: .....	4
1.4 AP Installation: .....	4
Chapter 2 Connect Wireless AP with PC:.....	6
Chapter 3: Login.....	7
Chapter 4 : WEB GUI interface Setting:.....	9
4.1 Status:.....	9
4.2 Wizard Configuration: .....	11
4.2.1 Gateway Mode:.....	11
4.2.2 WiFi Repeater mode.....	13
4.2.3 WISP Operation mode: .....	14
4.2.4 AP Operation mode:.....	16
4.3 Advanced Setting:.....	18
4.3.1 Device Status: .....	18
4.3.2 Wireless Basic settings:.....	19
4.3.3 Virtual AP: .....	20
4.3.4 Access Control: .....	20
4.3.5 Advanced Settings:.....	21
4.3.6 Network: .....	21
4.3.7 Management:.....	22
Chapter 5 Share Internet and Obtain IP address automatically .....	25
Chapter 6 Trouble Shooting:.....	26
Appendix A LICENSE STATEMENT / GPL CODE STATEMENT.....	27

# Chapter 1 Hardware and Operation mode Instruction



P1

## 1.1 LED indicator:

Green: Power Indicator

Blue: WiFi Indicator

## 1.2 AP Interface:

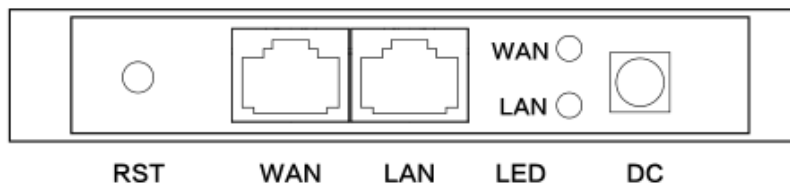

RST: Reset Button, it make AP revert to default data after press it 15 seconds.

WAN: WAN Port, connect with ADSL modem or Internet mainly. It will be LAN port under Wireless AP and WiFi Repeater operation mode

LAN: LAN Port to end users

LED: LED Indicator of WAN port and LAN port

DC: DC power connector

## 1.3 Power Supply:

The connection diagram shows as P2, Internet cable from PoE Switch to Ceiling AP's WAN Port, then PC access into ceiling AP wired/wireless.

Pls note the PD wireless AP support 48V IEEE 802.3af standard PoE, the PoE switch should comply with 802.3af 48V PoE standard.

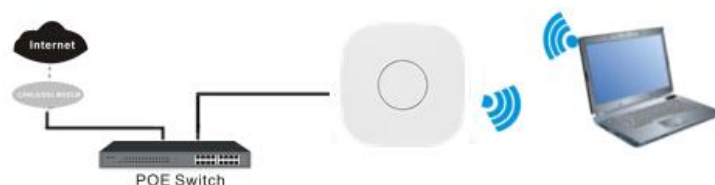

P2

## 1.4 AP Installation:

For the Ceiling Wireless AP, will be installed under ceiling based on following steps:

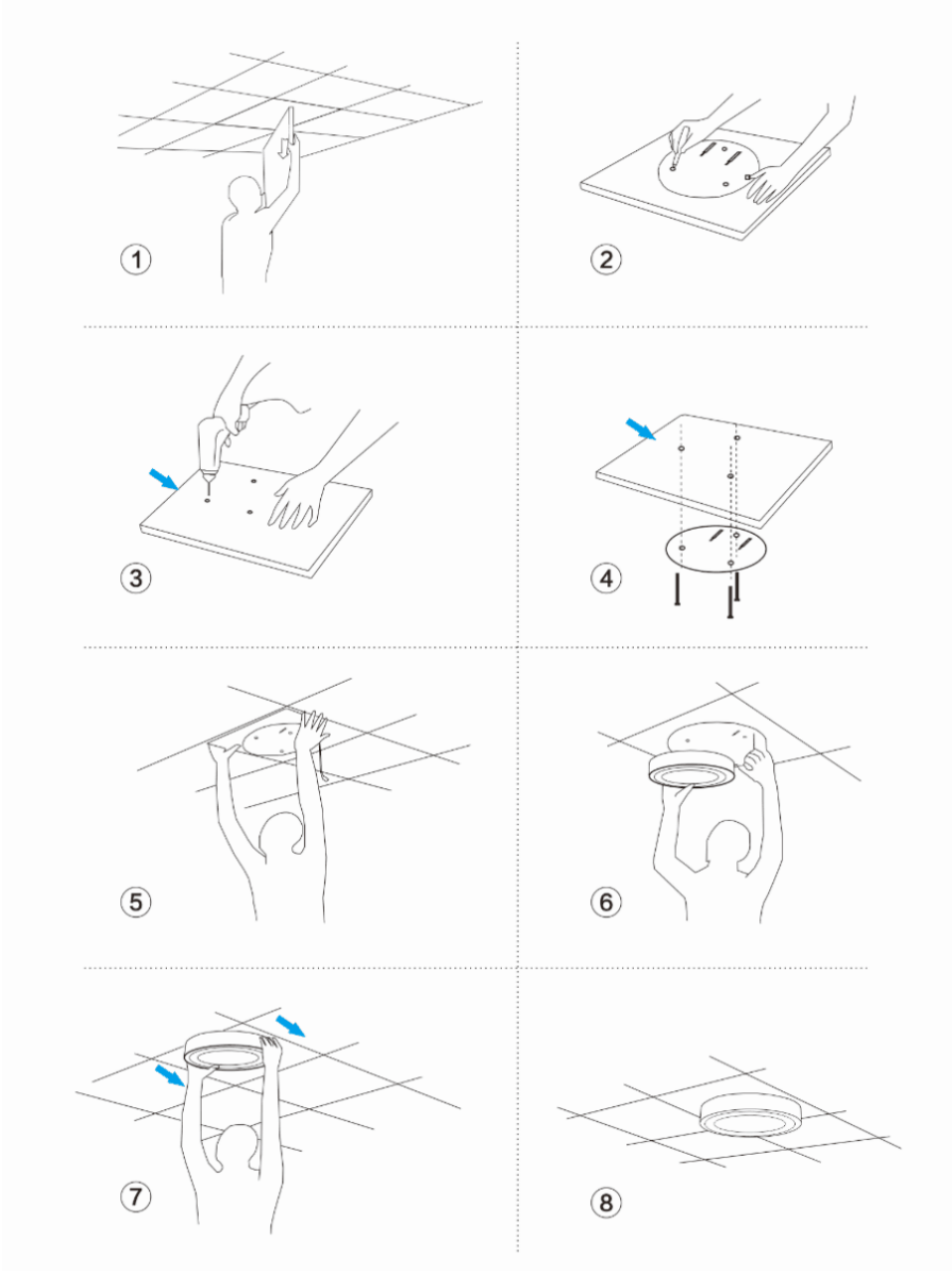

P3 AP installation

## Chapter 2 Connect Wireless AP with PC:

Use can connect the PC with wireless AP by Wireless SSID and LAN cable:  
The diagram of wireless connection showed as follow:  
Pls note: the default SSID is **LevelOne**, **SSID's password is 66666666**

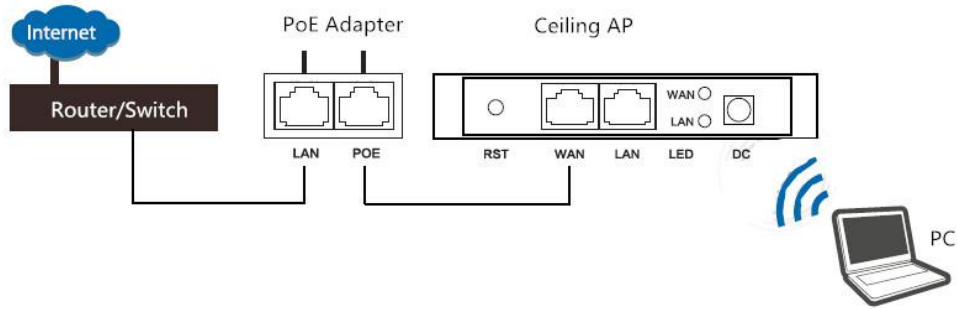

The diagram of LAN cable connection showed as follow:

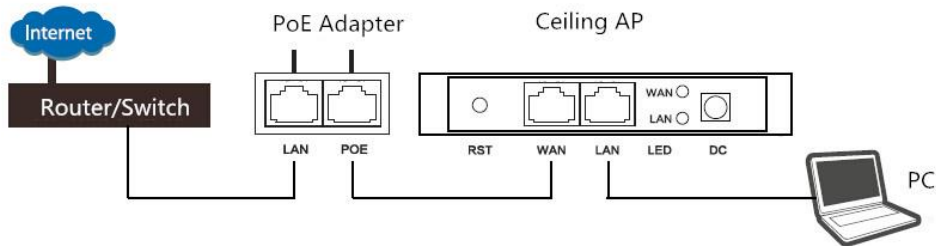

P4 Connection way

## Chapter 3: Login

The necessary information about log in is displayed on the sticker of the product, including the URL, User Name and Pass Word

- 1) Connect the Ceiling AP with computer
- 2) Configure the PC's local connection IP address as 192.168.188.X (X is number from 2 to 252), subnet mask is 255.255.255.0, follow P5 and P6 to finish.

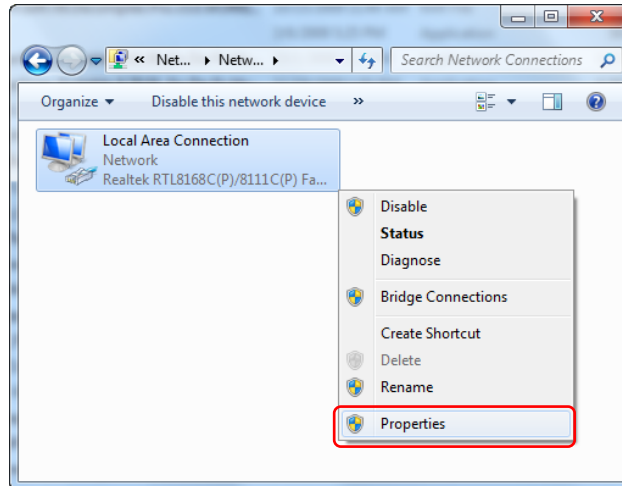

P5 Setting of computer's IP address

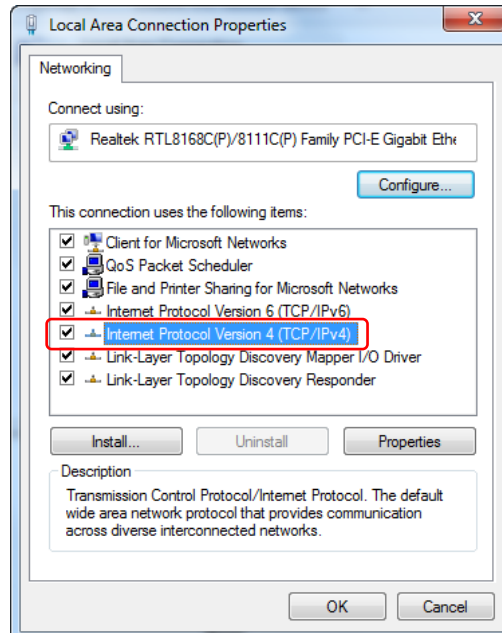

P 6 Setting of computer's IP address

3) Input 192.168.188.253 into IE browser, then pop up the login page, the default login password: admin, then login, pls do following P7

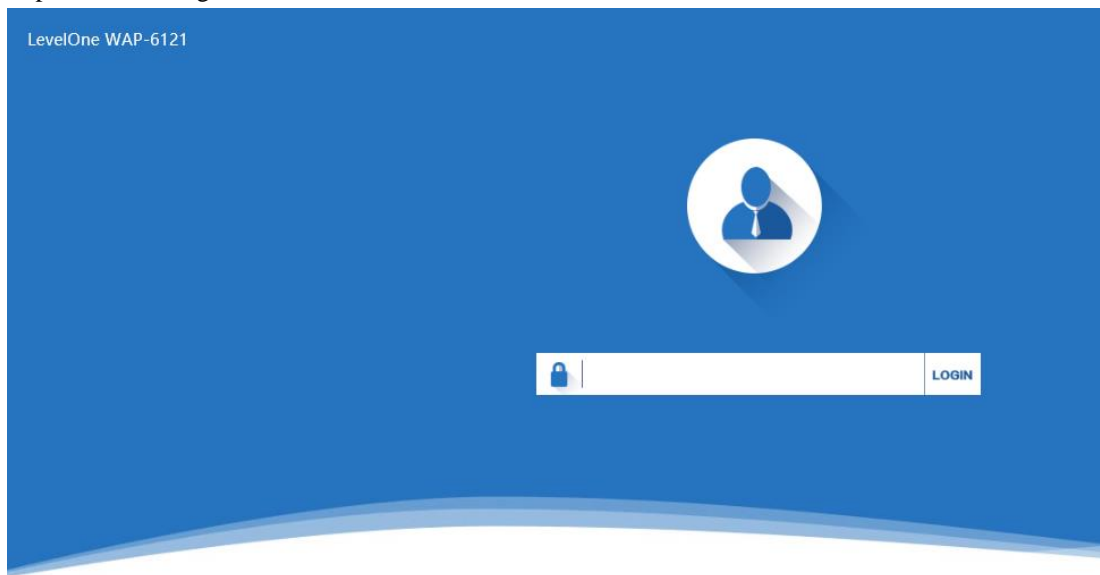

P7 Login

4) After login, then P8 Device Status will be showed;

This page will show the Wireless AP's default operation mode, channel, connection status, CPU usage, Wireless settings, LAN Setting, Wireless AP's Location, hardware/firmware version.

CPU usage	Wireless setting	LAN setting	AP position setting
11%	2.4G	192.168.188.253	
CPU Frequency:550MHz	LevelOne 00:11:6B:73:F9:9F	00:11:6B:73:F9:9D	

P8: Device Status



# Chapter 4 : WEB GUI interface Setting:

## 4.1 Status:

After login, then P9 Device Status and home page will be showed:

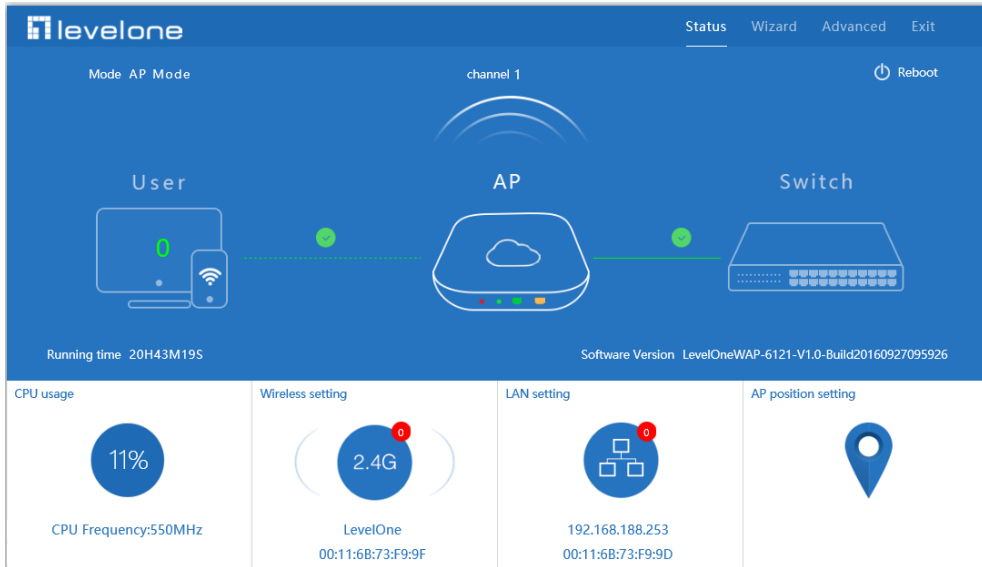

P9: Device Status

In this page, show the AP's default operation mode, channel, end user QTY, connection status, CPU usage status, Wireless, LAN and AP location info.

Then in Wireless Setting, GUI configuration page showed as below:

User can configure the SSID, password, band width, channel here, then Apply to finish.

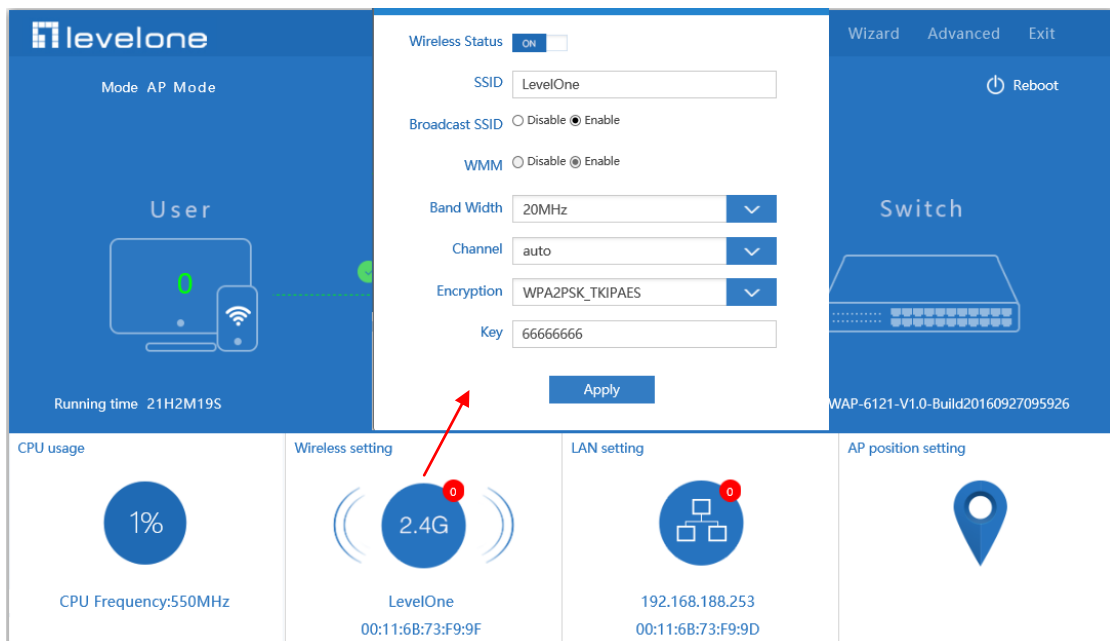

P10. Wireless setting

LAN Setting to configure the DHCP or Fix IP

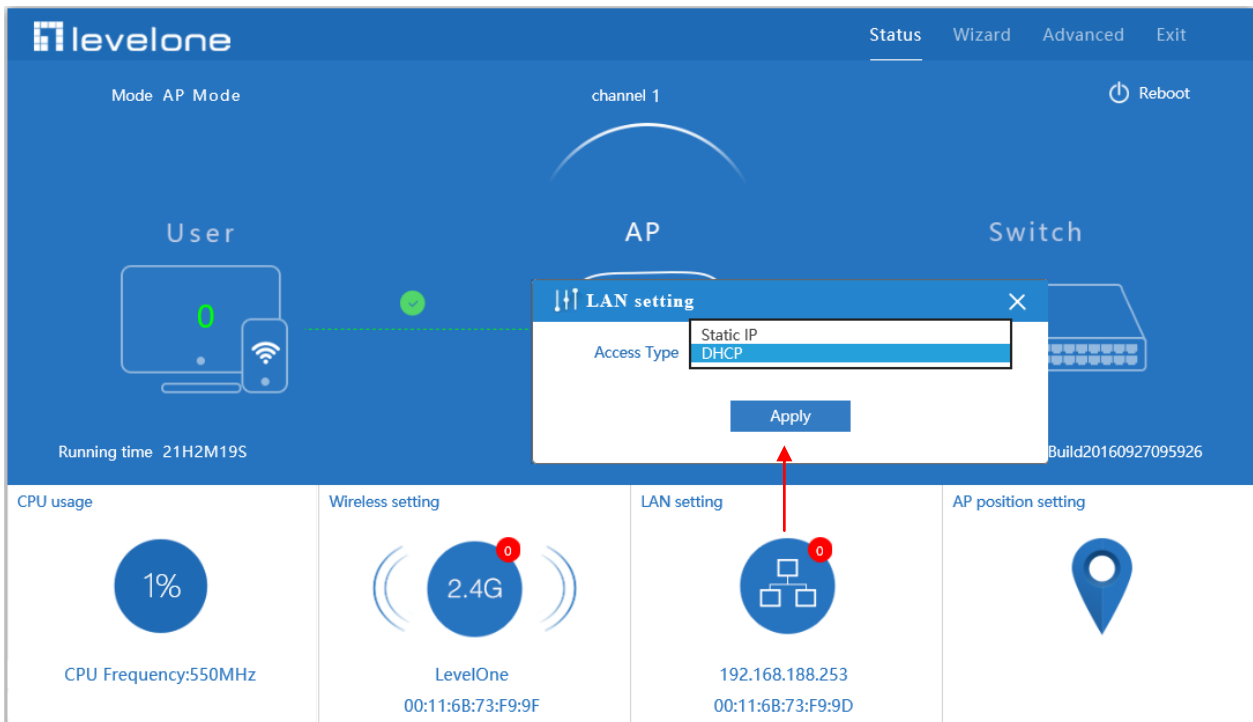

P11 LAN Setting

AP location setting: can mark where the AP set up, and AP name as P12:

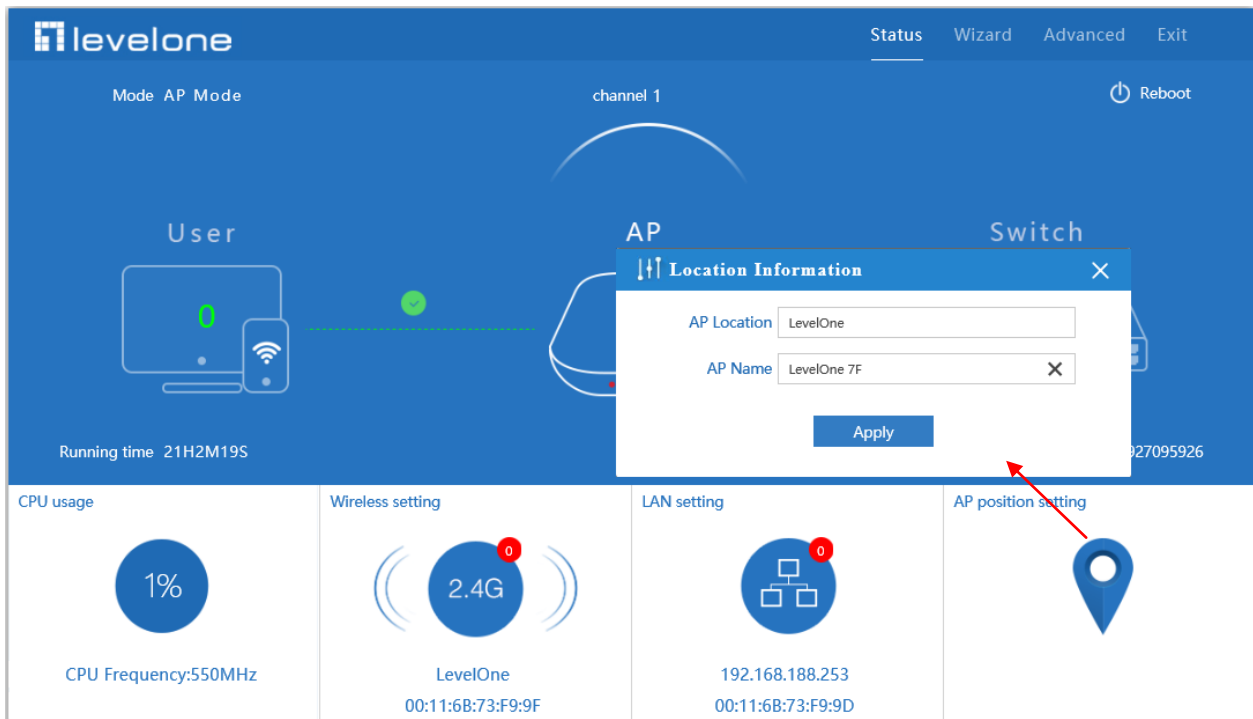

P12 AP Postion setting

## 4.2 Wizard Configuration:

Wizard: It instructs users to configure wireless AP's operation mode based on needs: there are four operation modes including gateway, repeater, WISP, and Wireless AP. Please confirm the operation mode first before configuration starts.

Click Wizard in the Status page, which will pop up the following page to configure the operation mode and there are explanations for each operation mode for better application.

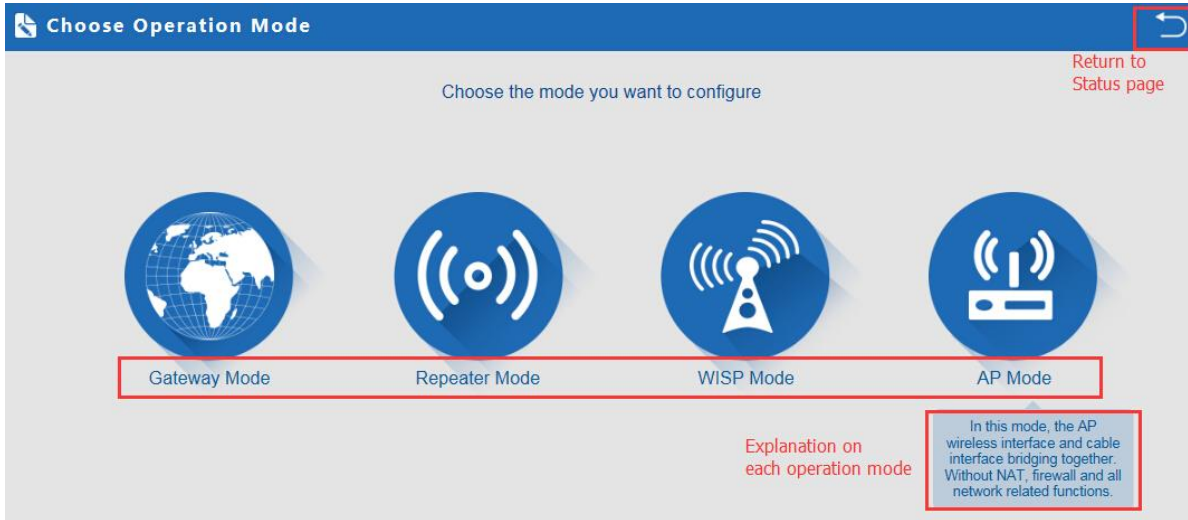

P13 Operation mode

### 4.2.1 Gateway Mode:

Before clicking Gateway mode, confirm your internet will be static IP, PPPoE, or DHCP:

Then it will pop up the following picture after clicking it. Please choose the right WAN setting mode, then click next to continue.

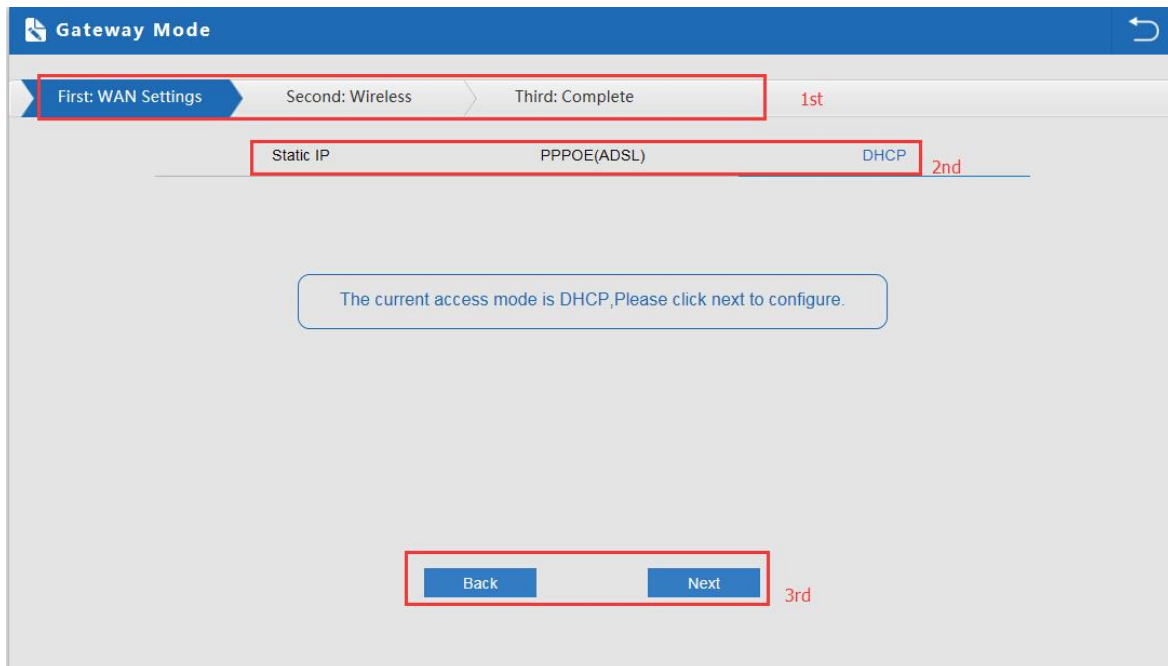

P14. WAN setting in Gateway Mode

Gateway Mode

First: WAN Settings    Second: Wireless    Third: Complete

Wireless Settings

Wireless Settings

WLAN Status  ON    wireless analyzer

SSID     Channel

Encryption     Key

Back    Next

P15 Wireless Setting in Gateway Mode

When click Next, then will complete the Gateway mode setting and show following picture:

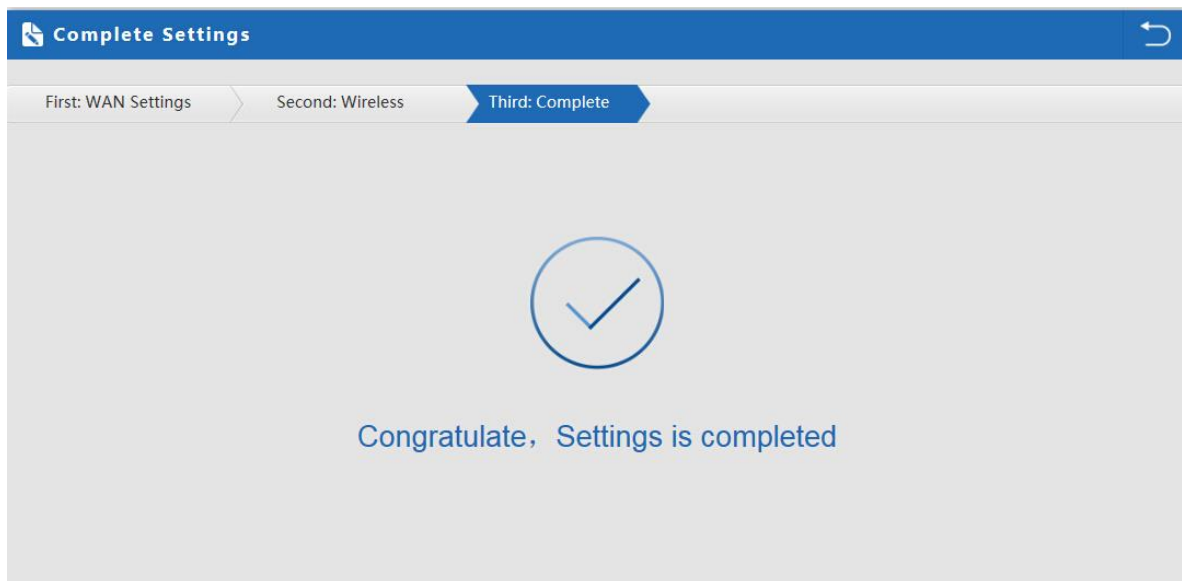

P16 Complete the setting in Gateway Mode

When return to Status, will show wireless router's SSID, internet connection, LAN connection status showed as follow:

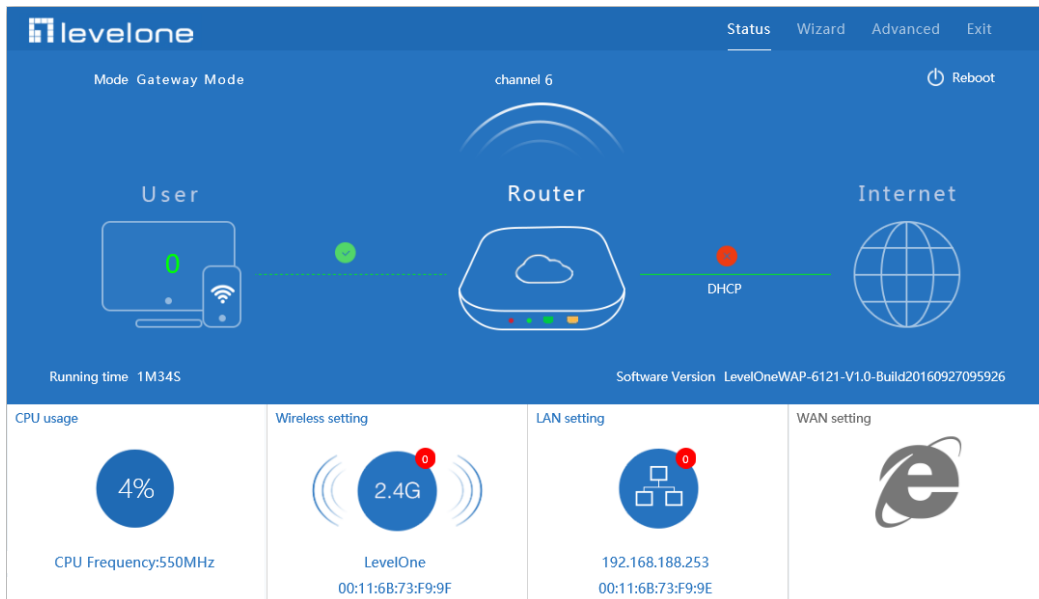

P17 Status in Gateway Mode

#### 4.2.2 WiFi Repeater mode

- A. Login the Web management page, click “Wizard”, then “WiFi Repeater”
- B. Select the AP’s SSID want to bridge, take “wireless 2.4G” for example, then input the AP’s key, click next to complete.

P18 Repeater Mode

Click Return button, will back to Status, show Repeater mode data, show fail or success, and user can configure this data in this page if required.

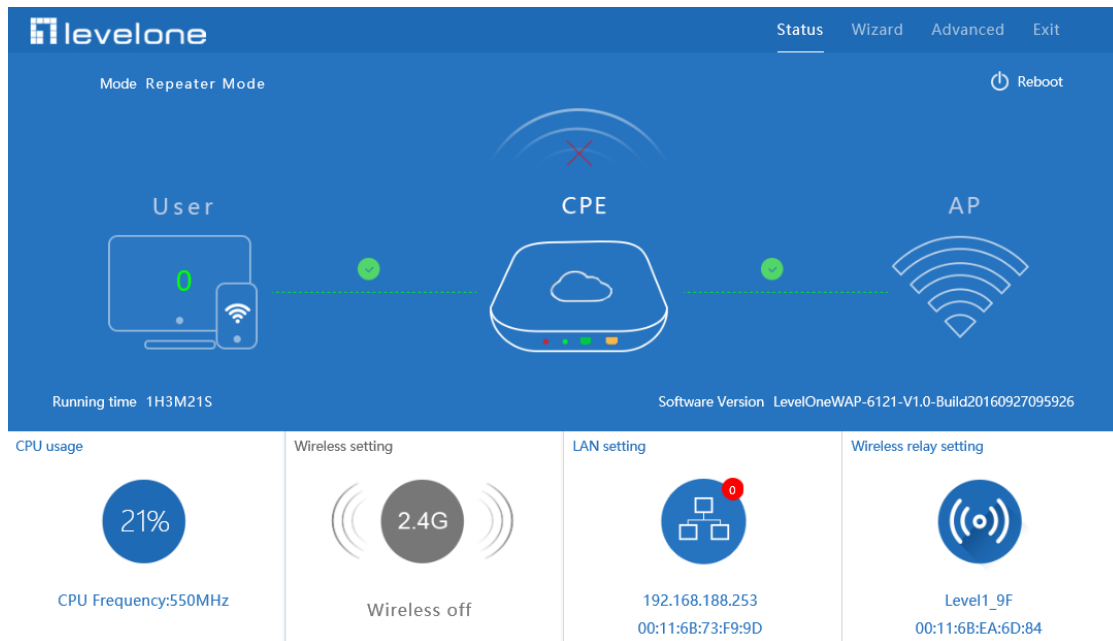

P19 Status in Repeater Mode

In wifi repeater operation mode, the default is SSID disable. If want to enable SSID, then click Wireless Setting. Pls note, when click wireless relay setting, following page will pop up, you can make change from here easy:

The screenshot shows the 'Repeater Mode' configuration page for 'Wireless Repeater'. It features a progress bar with 'First: Repeater' and 'Second: Complete' steps. The configuration fields are:

- Repeater SSID: Level1\_9F (with a 'Scan AP' button)
- Authentication: WPAPSK\_TKIPAES (dropdown menu)
- Key: 1234567890
- Band Width: 20MHz (dropdown menu)
- WDS Passthrough

At the bottom, there are 'Back' and 'Next' buttons.

P20 Wireless Relay Setting

### 4.2.3 WISP Operation mode:

Click WISP operation mode in Wizard, then will pop up the configure page, pls set the WISP operation mode based on the steps showed in picture:

WISP Mode

First: Repeater    Second: WAN    Third: Complete

Wireless Repeater

Repeater SSID:

Authentication:  ▼

Key:

P21 WISP Mode

Configure the right WAN setting in WISP operation mode, then next to complete

WISP Mode

First: Repeater    Second: WAN    Third: Complete

Static IP    PPPOE(ADSL)    DHCP

IP Address:

Subnet Mask:

Default Gateway:

Primary DNS:

P22 WAN setting in WISP mode

Then complete and back to status, will show the connection fail or success, then can configure the data based on request:

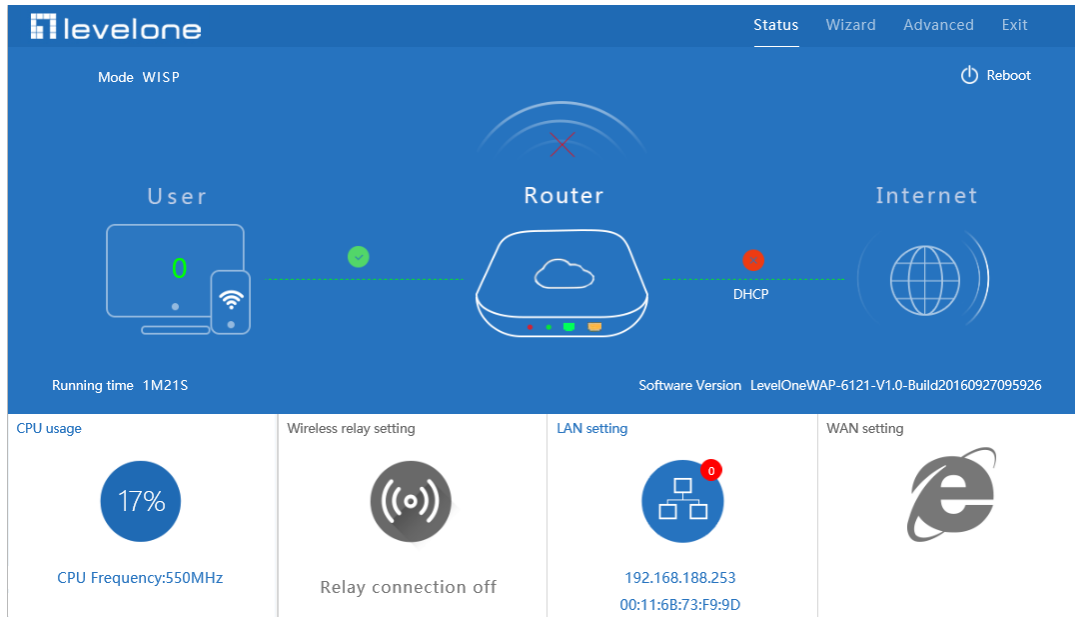

P23 Status in WISP mode

Remark: When click WAN Setting, will pop up following picture to ask you choose PPPoE, DHCP or Static IP

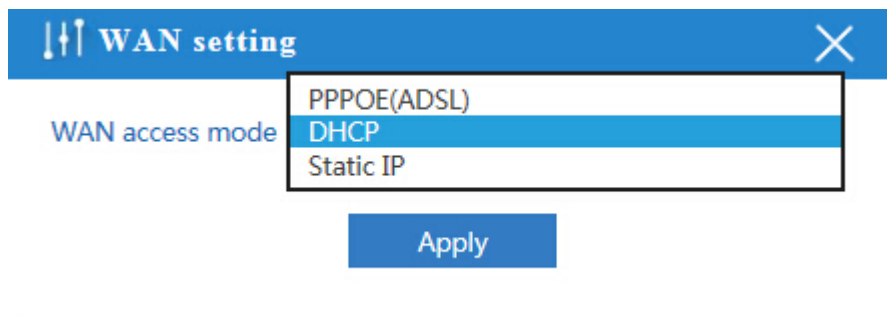

P24 WAN setting in WISP mode

#### 4.2.4 AP Operation mode:

Set the wireless data, AP Location info as required, then click next to continue and enter into LAN setting. After LAN setting, complete the AP mode configuration and back to Status:



AP Mode

First: Wireless    Second : LAN    Third:Complete

Wireless Settings

Wireless Settings

WLAN Status  wireless analyzer

SSID LevelOne

Channel auto

Encryption WPA2PSK\_AES

Key 1234567890

Location Information

AP Location

AP Name

Back    Next

P25 Wireless setting in AP Mode

AP Mode

First: Wireless    **Second : LAN**    Third:Complete

LAN setting

Access Type DHCP from Controller

Back    Next

P26 LAN Setting in AP Mode

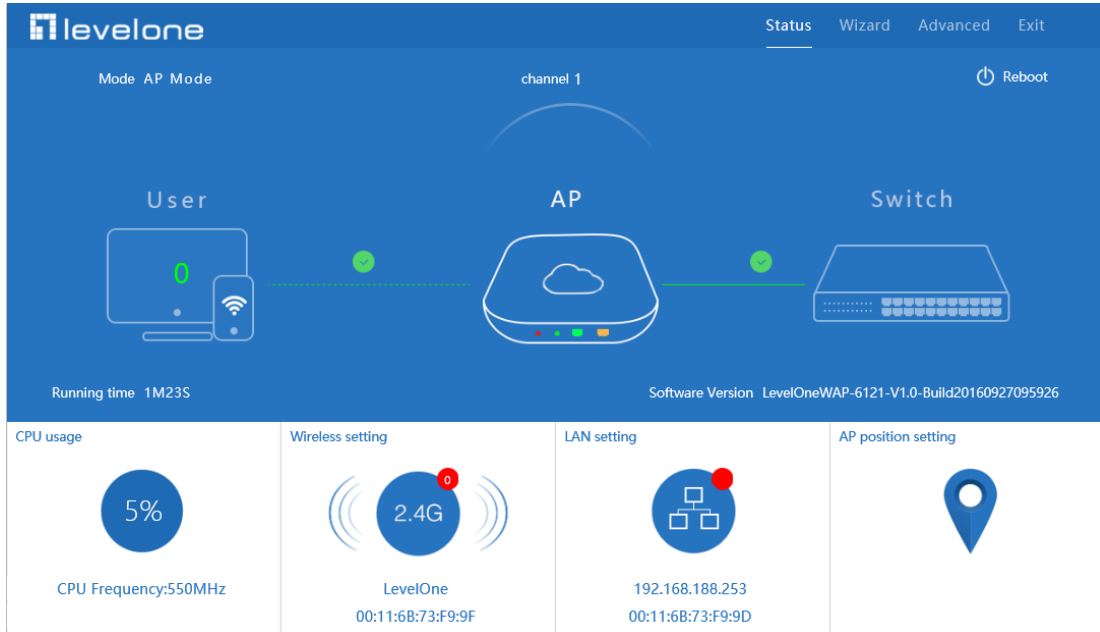

P27 Status in AP Mode

### 4.3 Advanced Setting:

In advanced setting, mainly for wireless AP's device status, wireless setting, Networking setting and AP management configure.

Let's Click Advanced Setting in status page, will show return home, Setup Wizard which we showed before.

Let's shown more in Device Status, Wireless, Network and Management in following pages:

#### 4.3.1 Device Status:

to show the Wireless AP's status, Wireless Status and LAN status.

In status, mainly to check the ceiling wireless AP's firmware version, hardware version, uptime info.:

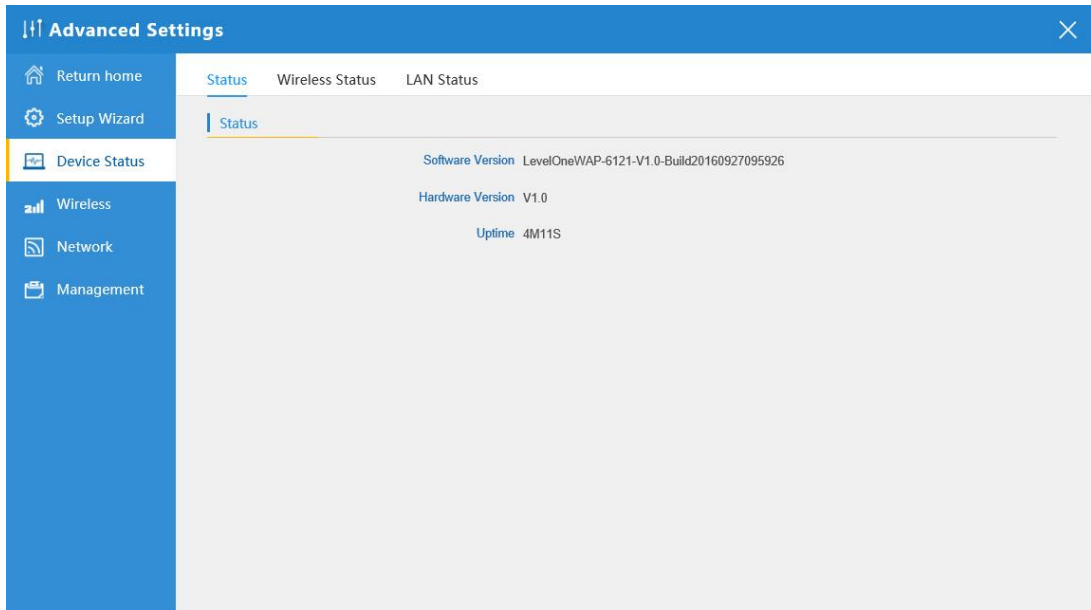

P28 Device Status

In wireless status, to show wireless AP's SSID, MAC address for WiFi, Channel, Encryption, Client List info.

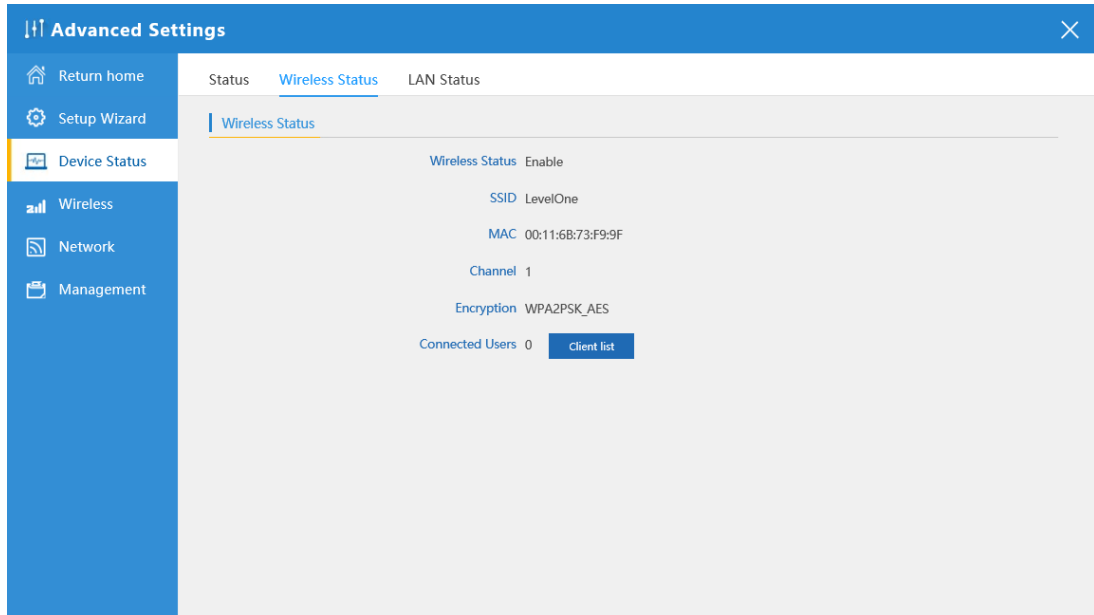

P29 Wireless Status

In LAN Status, we can check wireless AP's IP address, Subnet Mask, LAN MAC address and other info showed in following picture.

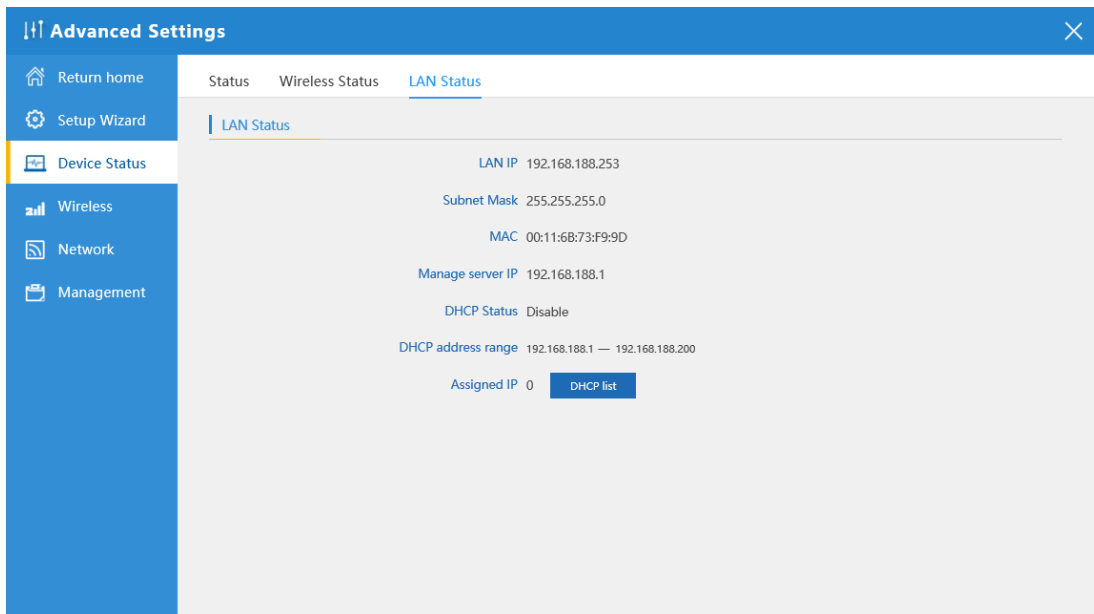

LAN Status

### 4.3.2 Wireless Basic settings:

For wireless basic settings, mainly to configure the wireless SSID, password, band width ,encryption, channel, Multi SSID.

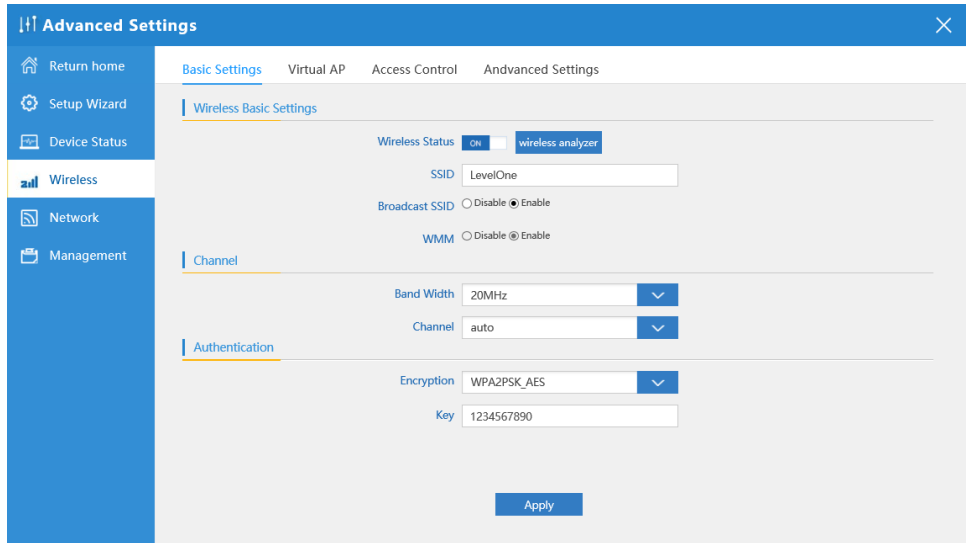

P31 Basic Setting in Wireless

### 4.3.3 Virtual AP:

There are 3 virtual AP in 2.4G wireless, if need do multi SSID, then users can configure it showed in following picture:

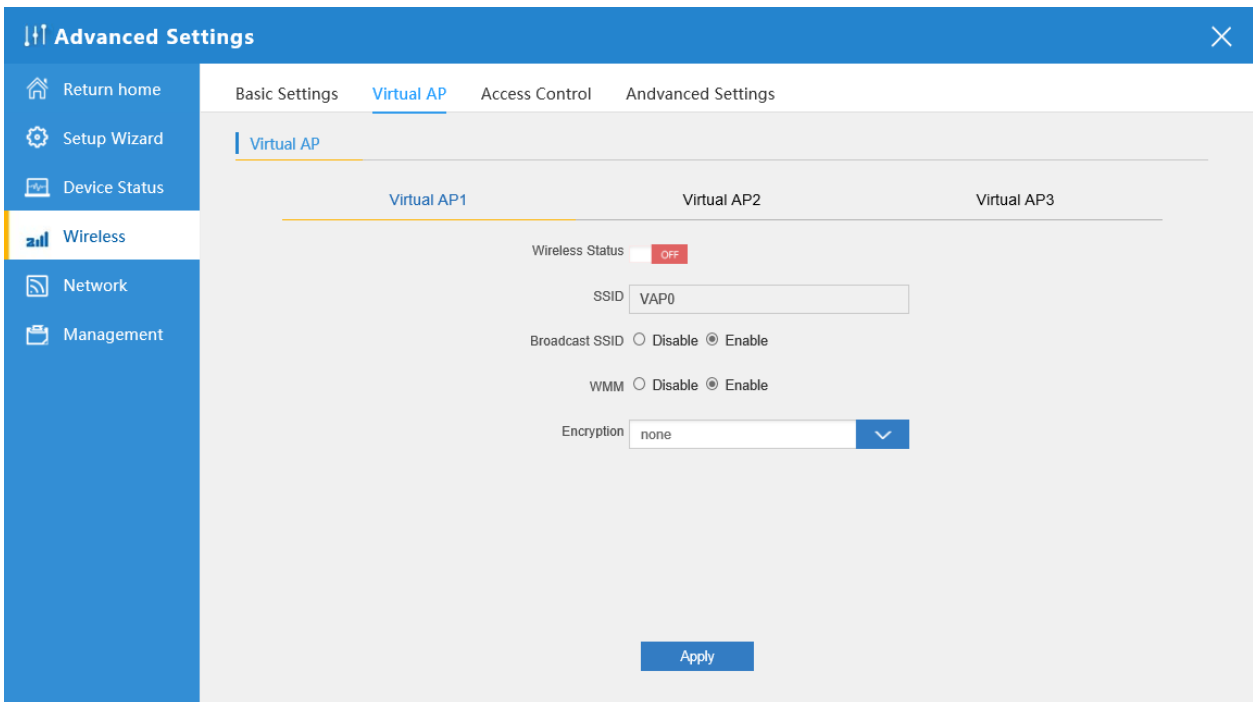

P32 Virtual AP

### 4.3.4 Access Control:

Allow or deny the users access into this wireless AP based on MAC address.

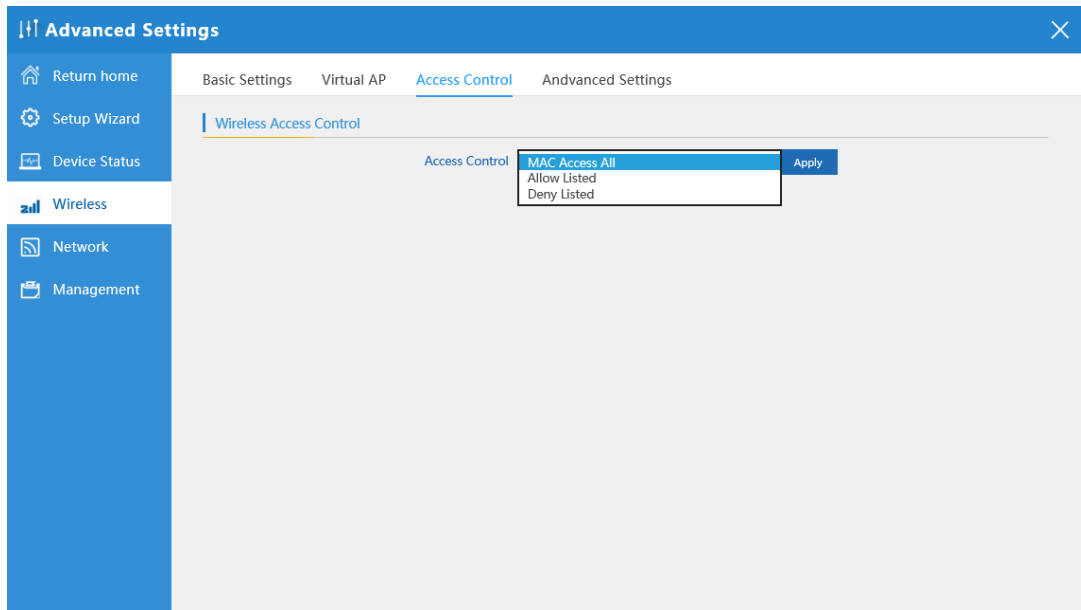

P33 MAC Access Control

### 4.3.5 Advanced Settings:

In this page, will show the regional, mode, RF Power, Max user access...

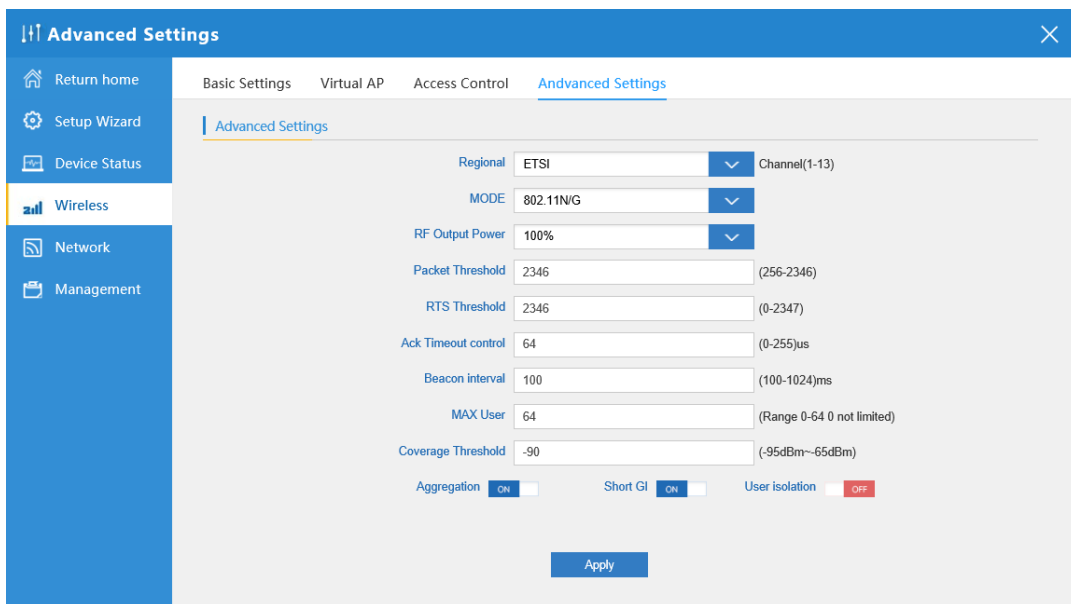

P34 Advanced Setting

### 4.3.6 Network:

In network, mainly to show the LAN setting and tag VLAN as follow:

In LAN Settings, mainly including static IP and DHCP.

DHCP from controller means you are allowing controller to manage the IP of the AP and end users. That is to say only when DHCP from controller is chosen can the controller find and manage the AP.

Static IP means the AP has the right to manage its own IP address. When the IP segment of the AP is same as

controller's, the AP can also be found and managed by controller.

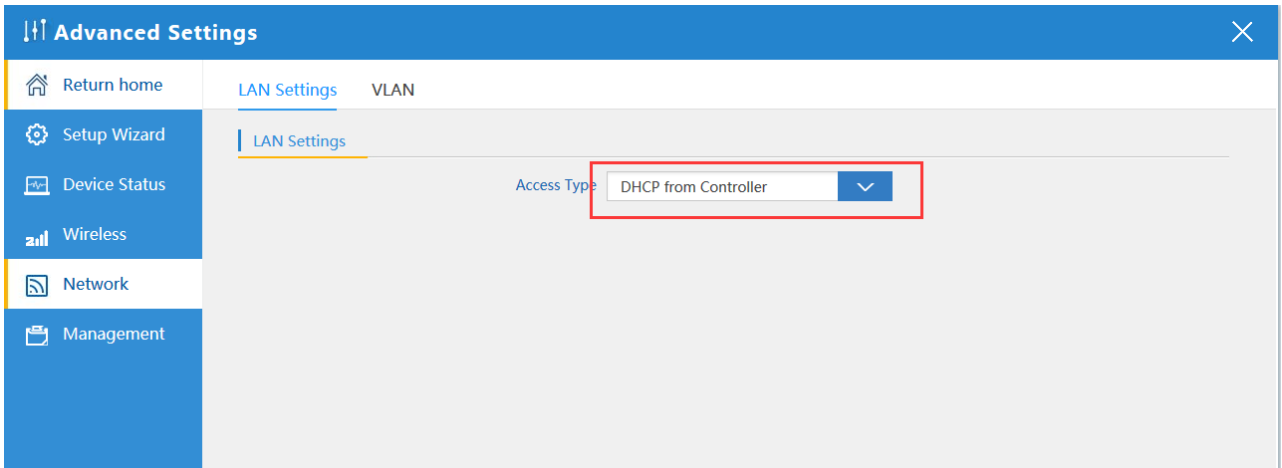

### P35 Network Setting

In VLAN part, need an VLAN switch and make sure the multi SSID is enable, then input the VLAN ID to different SSID.

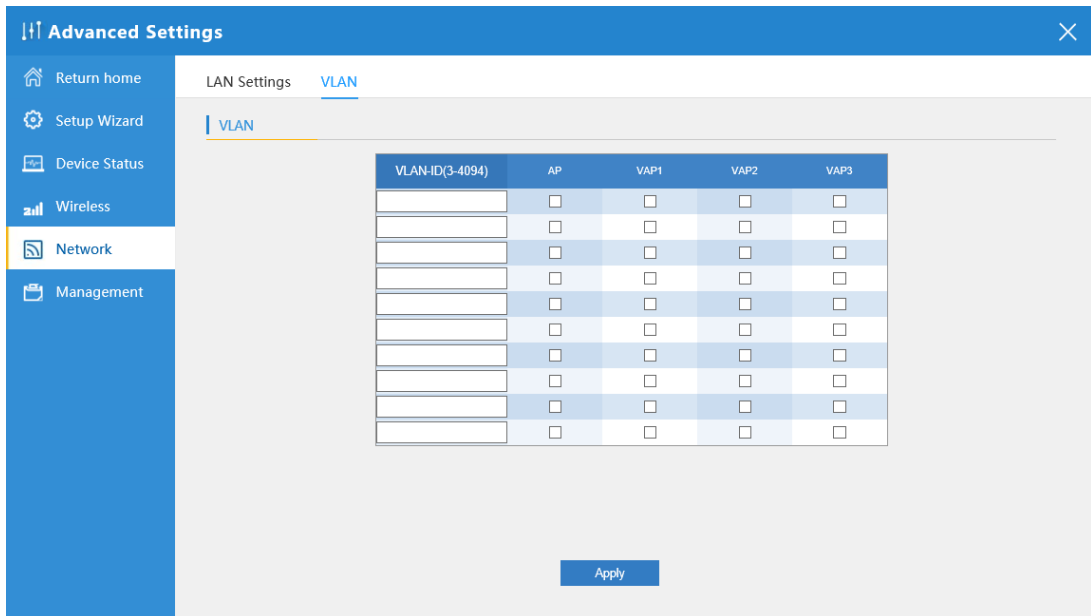

### P36 Tag VLAN Setting

#### 4.3.7 Management:

In this part, show the system time, Logs, upgrade firmware, system, user info.

And we show System time, how to upgrade firmware and system page to users:

Get time from NTP server can only be available under Gateway and WISP Mode. Before sync with host, please select your Time zone.

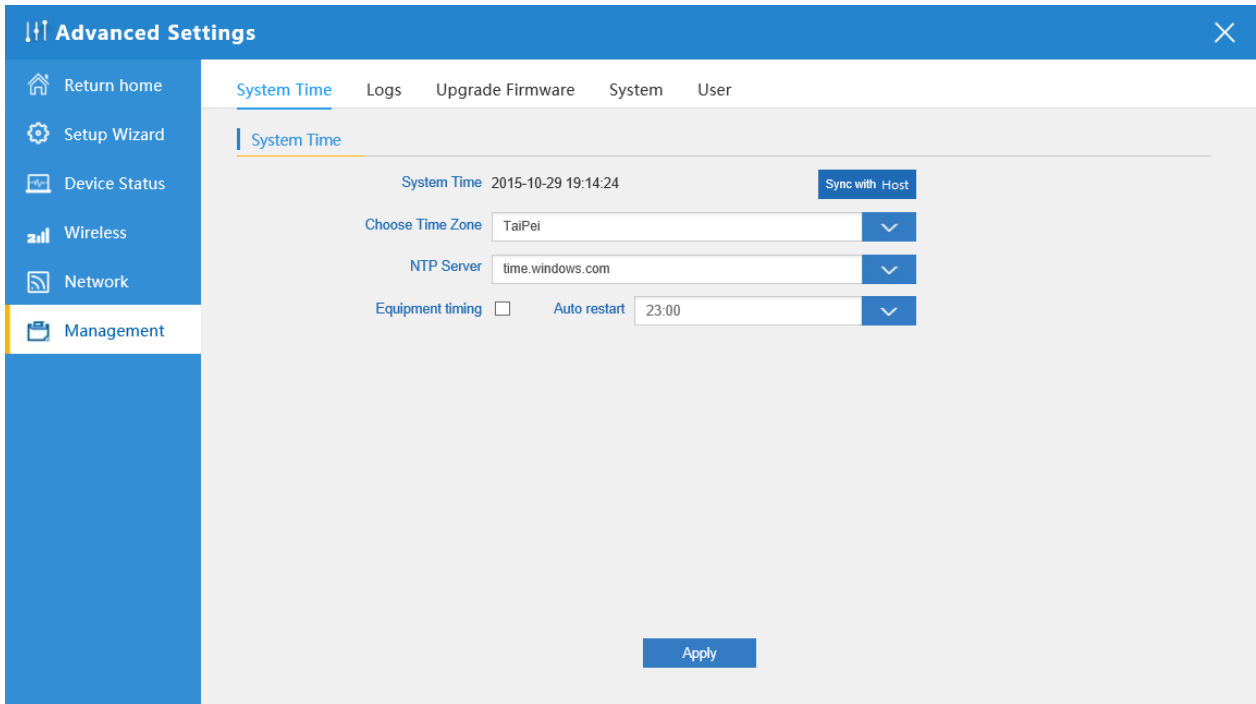

P37 System Time

In Logs part, you can copy the running history of the device to consult the engineers when you have any trouble.

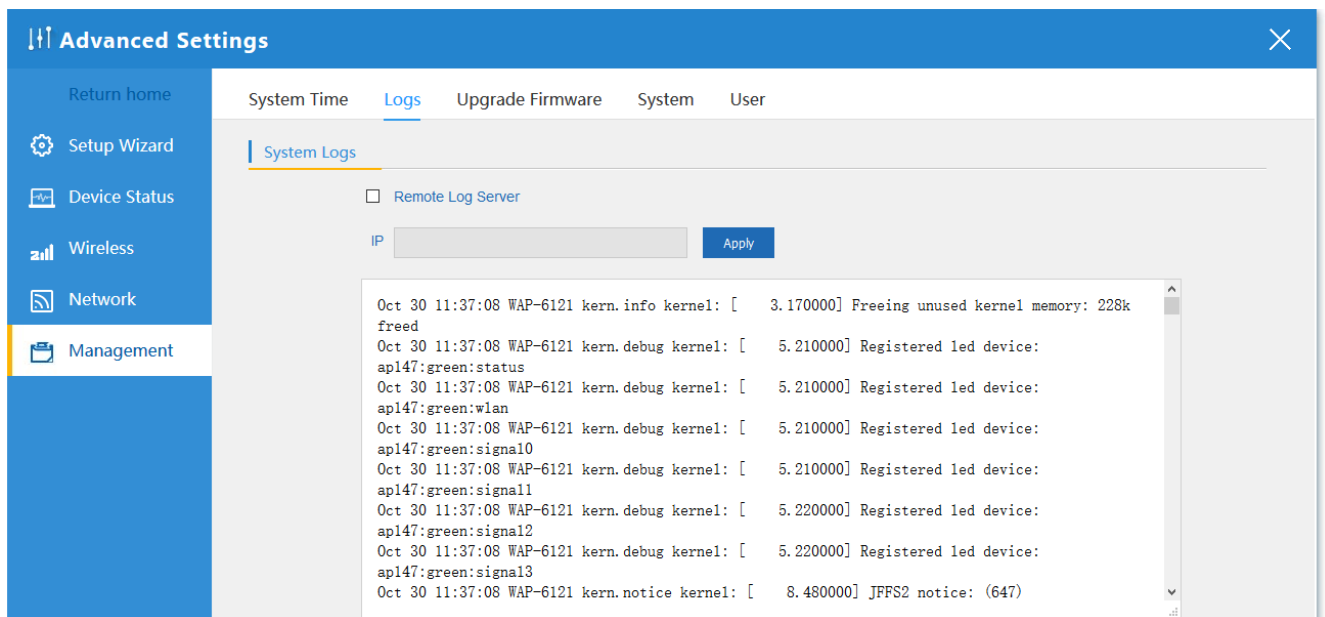

P38 Logs

Upgrade Firmware allows you to browse the new firmware in your computer and upgrade. Please do not power off the device during upgrade.

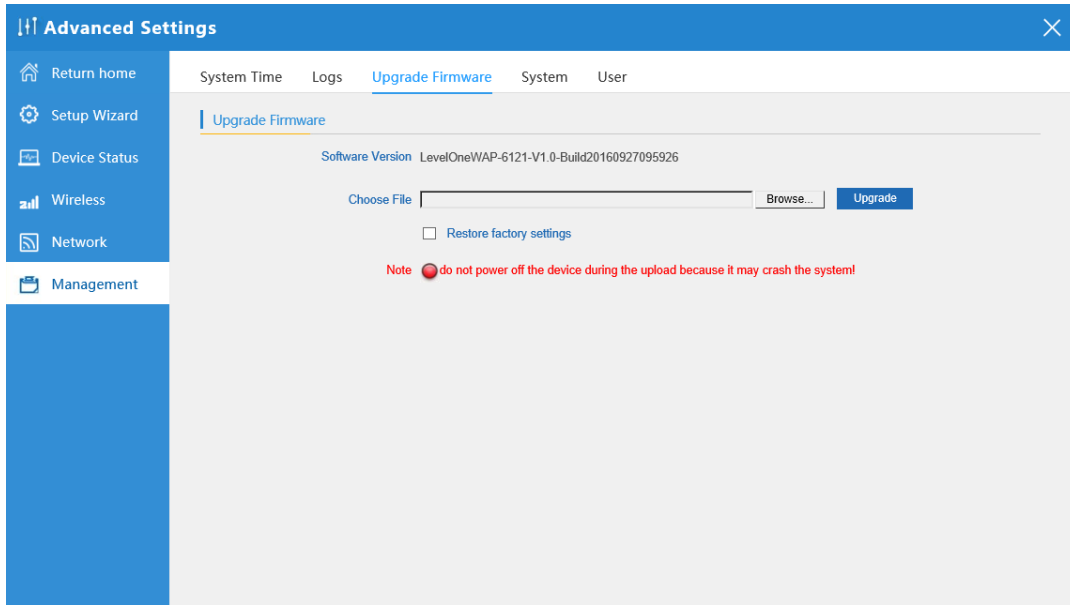

P39 Firmware Upgrade

You are able to backup the current configuration to your PC and restore by applying the configuration file from your PC.

And you can Reset and Reboot the device with just one click.

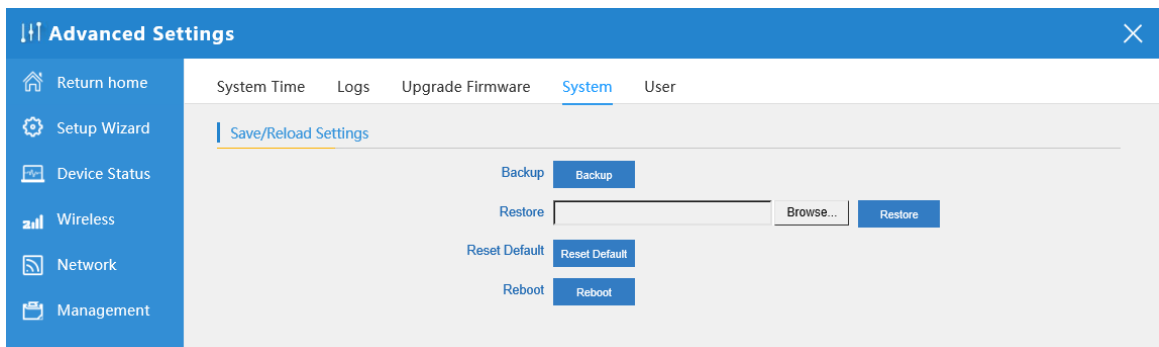

P40 System info

In user part, you can change the password for Log in

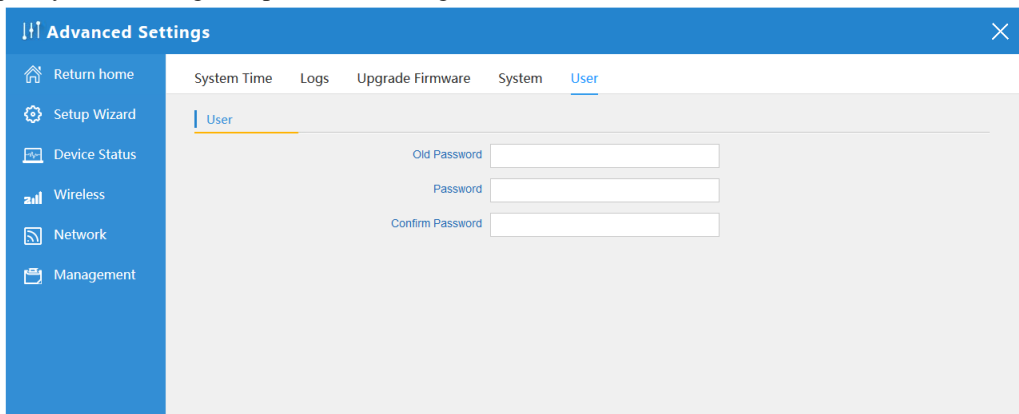



## Chapter 5 Share Internet and Obtain IP address automatically

Set computer's TCP/IP as Obtain an IP address automatically, Obtain DNS server address automatically as following picture showed.

the computer will obtain the IP address from router or base station to get Internet.

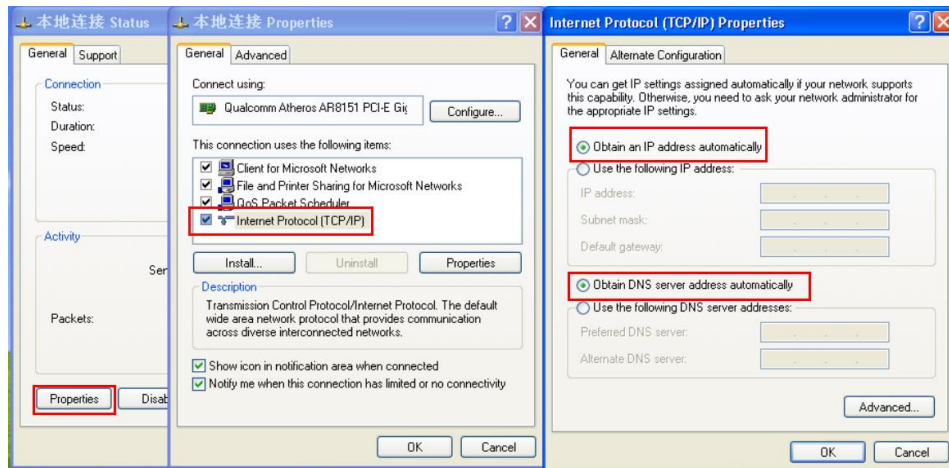

## Chapter 6 Trouble Shooting:

### F 1 The Failure phenomenon and solution

Failure phenomenon	Solution
SYS Indicator off	Pls make sure the PoE module connection is right. POE Port connect with AP, LAN port connect with computer
Can't land to Wireless AP through Web page	Pls check the IP address of computer and Wireless AP to see whether they are in same networking segment, The method is click "start"- "Run" input "cmd", ping 192.168.188.253 to test the Wireless AP connectivity. Reset Wireless AP and load it again; Pls make sure the IP address 192.168.188.253 is not occupied by other device in Wireless AP's networking; Check computer and cable problem, recommend to use 10/100M UTP unshielded cable; Clean up Arp binding from "Start"- "Run" input "cmd" arp -d Clean the IE Brower's temporary files and Cache file.
Wireless AP can't connect with AP (the status display unconnected)	Try to scan the available wireless networking again; Make sure the Wireless AP's wireless standard is correct; (2.4Ghz signal should connect 2.4Ghz.) The Security and passwords are matched between Wireless AP and AP; The signal strength of AP is too weak to connect, should be more than -75dBm;
Can't scan the wireless AP	Scan it several times more; If using 5Ghz to scan, please make sure there are 5G signal existed. Reset the Wireless AP, scan it again after Wireless AP restart;
The connection of Wireless AP and AP is success, but the computer can't share internet	Pls Check the computer's IP address and DNS setting. If it is dynamin, set the network card as automatically obtain. If it is static IP, pls contact with ISP for correct IP address and DNS address.
How to Reset Wireless AP	Press the "Reset" button more than 15 seconds after power on. The Wireless AP will restore factory default after the Wireless AP restart.

# **Appendix A LICENSE STATEMENT / GPL CODE STATEMENT**

This product resp. the here

(<http://global.level1.com/downloads.php?action=init>) for

downloading offered software includes software code developed by third parties, including software code subject to the GNU General Public License Version 2 (“GPLv2”) and GNU Lesser General Public License 2.1 („LGPLv2.1“).

## **WRITTEN OFFER FOR GPL/LGPL SOURCE CODE**

We will provide everyone upon request the applicable GPLv2 and LGPLv2.1 source code files via CDROM or similar storage medium for a nominal cost to cover shipping and media charges as allowed under the GPLv2 and LGPLv2.1. This offer is valid for 3 years. GPLv2 and LGPLv2 inquiries: Please direct all GPL and LGPL inquiries to the following address:

Digital Data Communications GmbH  
Zeche-Norm-Str. 25  
44319 Dortmund

Deutschland

Phone: [+49 231 9075 - 0](tel:+4923190750)

Fax: [+49 231 9075 - 184](tel:+492319075184)

Email: [support@level1.com](mailto:support@level1.com)

Web: [www.level1.com](http://www.level1.com)

## **NO WARRANTY**

This program is distributed in the hope that it will be useful, but WITHOUT ANY WARRANTY; without even the implied warranty of MERCHANTABILITY or FITNESS FOR A PARTICULAR PURPOSE. See the GNU General Public License for more details. IN NO EVENT UNLESS REQUIRED BY APPLICABLE LAW OR AGREED TO IN WRITING WILL ANY COPYRIGHT HOLDER, OR ANY OTHER PARTY WHO MAY MODIFY AND/OR REDISTRIBUTE THE PROGRAM AS PERMITTED ABOVE, BE LIABLE TO YOU FOR DAMAGES, INCLUDING ANY GENERAL, SPECIAL, INCIDENTAL OR CONSEQUENTIAL DAMAGES ARISING OUT OF THE USE OR INABILITY TO USE THE PROGRAM (INCLUDING BUT NOT LIMITED TO LOSS OF DATA OR DATA BEING RENDERED INACCURATE OR LOSSES

SUSTAINED BY YOU OR THIRD PARTIES OR A FAILURE OF THE PROGRAM TO OPERATE WITH ANY OTHER PROGRAMS), EVEN IF SUCH HOLDER OR OTHER PARTY HAS BEEN ADVISED OF THE POSSIBILITY OF SUCH DAMAGES.

# **GNU GENERAL PUBLIC LICENSE**

Version 2, June 1991

Copyright (C) 1989, 1991 Free Software Foundation, Inc.  
51 Franklin Street, Fifth Floor, Boston, MA 02110-1301, USA

Everyone is permitted to copy and distribute verbatim copies of this license document, but changing it is not allowed.

## **Preamble**

The licenses for most software are designed to take away your freedom to share and change it. By contrast, the GNU General Public License is intended to guarantee your freedom to share and change free software--to make sure the software is free for all its users. This General Public License applies to most of the Free Software Foundation's software and to any other program whose authors commit to using it. (Some other Free Software Foundation software is covered by the GNU Lesser General Public License instead.) You can apply it to your programs, too.

When we speak of free software, we are referring to freedom, not price. Our General Public Licenses are designed to make sure that

you have the freedom to distribute copies of free software (and charge for this service if you wish), that you receive source code or can get it if you want it, that you can change the software or use pieces of it in new free programs; and that you know you can do these things.

To protect your rights, we need to make restrictions that forbid anyone to deny you these rights or to ask you to surrender the rights. These restrictions translate to certain responsibilities for you if you distribute copies of the software, or if you modify it.

For example, if you distribute copies of such a program, whether gratis or for a fee, you must give the recipients all the rights that you have. You must make sure that they, too, receive or can get the source code. And you must show them these terms so they know their rights.

We protect your rights with two steps: (1) copyright the software, and (2) offer you this license which gives you legal permission to copy, distribute and/or modify the software.

Also, for each author's protection and ours, we want to make certain that everyone understands that there is no warranty for this free software. If the software is modified by someone else and passed on, we want its recipients to know that what they have is

not the original, so that any problems introduced by others will not reflect on the original authors' reputations.

Finally, any free program is threatened constantly by software patents. We wish to avoid the danger that redistributors of a free program will individually obtain patent licenses, in effect making the program proprietary. To prevent this, we have made it clear that any patent must be licensed for everyone's free use or not licensed at all.

The precise terms and conditions for copying, distribution and modification follow.

## **TERMS AND CONDITIONS FOR COPYING, DISTRIBUTION AND MODIFICATION**

0. This License applies to any program or other work which contains a notice placed by the copyright holder saying it may be distributed under the terms of this General Public License. The "Program", below, refers to any such program or work, and a "work based on the Program" means either the Program or any derivative work under copyright law: that is to say, a work containing the Program or a portion of it, either verbatim or with modifications and/or translated into another language. (Hereinafter,

translation is included without limitation in the term "modification".)

Each licensee is addressed as "you".

Activities other than copying, distribution and modification are not covered by this License; they are outside its scope. The act of running the Program is not restricted, and the output from the Program is covered only if its contents constitute a work based on the Program (independent of having been made by running the Program). Whether that is true depends on what the Program does.

**1.** You may copy and distribute verbatim copies of the Program's source code as you receive it, in any medium, provided that you conspicuously and appropriately publish on each copy an appropriate copyright notice and disclaimer of warranty; keep intact all the notices that refer to this License and to the absence of any warranty; and give any other recipients of the Program a copy of this License along with the Program.

You may charge a fee for the physical act of transferring a copy, and you may at your option offer warranty protection in exchange for a fee.

**2.** You may modify your copy or copies of the Program or any portion of it, thus forming a work based on the Program, and copy and distribute such modifications or work under the terms of



Section 1 above, provided that you also meet all of these conditions:

**a)** You must cause the modified files to carry prominent notices stating that you changed the files and the date of any change.

**b)** You must cause any work that you distribute or publish, that in whole or in part contains or is derived from the Program or any part thereof, to be licensed as a whole at no charge to all third parties under the terms of this License.

**c)** If the modified program normally reads commands interactively when run, you must cause it, when started running for such interactive use in the most ordinary way, to print or display an announcement including an appropriate copyright notice and a notice that there is no warranty (or else, saying that you provide a warranty) and that users may redistribute the program under these conditions, and telling the user how to view a copy of this License. (Exception: if the Program itself is interactive but does not normally print such an announcement, your work based on the Program is not required to print an announcement.)

These requirements apply to the modified work as a whole. If identifiable sections of that work are not derived from the Program, and can be reasonably considered independent and separate works in themselves, then this License, and its terms, do not apply to those sections when you distribute them as separate works. But when you distribute the same sections as part of a whole which is a work based on the Program, the distribution of the whole must be on the terms of this License, whose permissions for other licensees extend to the entire whole, and thus to each and every part regardless of who wrote it.

Thus, it is not the intent of this section to claim rights or contest your rights to work written entirely by you; rather, the intent is to exercise the right to control the distribution of derivative or collective works based on the Program.

In addition, mere aggregation of another work not based on the Program with the Program (or with a work based on the Program) on a volume of a storage or distribution medium does not bring the other work under the scope of this License.

**3.** You may copy and distribute the Program (or a work based on it, under Section 2) in object code or executable form under the terms of Sections 1 and 2 above provided that you also do one of the following:

we use this doubled UL to get the sub-sections indented, while making the bullets as unobvious as possible.

**a)** Accompany it with the complete corresponding machine-readable source code, which must be distributed under the terms of Sections 1 and 2 above on a medium customarily used for software interchange; or,

**b)** Accompany it with a written offer, valid for at least three years, to give any third party, for a charge no more than your cost of physically performing source distribution, a complete machine-readable copy of the corresponding source code, to be distributed under the terms of Sections 1 and 2 above on a medium customarily used for software interchange; or,

**c)** Accompany it with the information you received as to the offer to distribute corresponding source code. (This alternative is allowed only for noncommercial distribution and only if you received the program in object code or executable form with such an offer, in accord with Subsection b above.)

The source code for a work means the preferred form of the work for making modifications to it. For an executable work, complete

source code means all the source code for all modules it contains, plus any associated interface definition files, plus the scripts used to control compilation and installation of the executable. However, as a special exception, the source code distributed need not include anything that is normally distributed (in either source or binary form) with the major components (compiler, kernel, and so on) of the operating system on which the executable runs, unless that component itself accompanies the executable.

If distribution of executable or object code is made by offering access to copy from a designated place, then offering equivalent access to copy the source code from the same place counts as distribution of the source code, even though third parties are not compelled to copy the source along with the object code.

**4.** You may not copy, modify, sublicense, or distribute the Program except as expressly provided under this License. Any attempt otherwise to copy, modify, sublicense or distribute the Program is void, and will automatically terminate your rights under this License. However, parties who have received copies, or rights, from you under this License will not have their licenses terminated so long as such parties remain in full compliance.

**5.** You are not required to accept this License, since you have not signed it. However, nothing else grants you permission to modify

or distribute the Program or its derivative works. These actions are prohibited by law if you do not accept this License. Therefore, by modifying or distributing the Program (or any work based on the Program), you indicate your acceptance of this License to do so, and all its terms and conditions for copying, distributing or modifying the Program or works based on it.

**6.** Each time you redistribute the Program (or any work based on the Program), the recipient automatically receives a license from the original licensor to copy, distribute or modify the Program subject to these terms and conditions. You may not impose any further restrictions on the recipients' exercise of the rights granted herein. You are not responsible for enforcing compliance by third parties to this License.

**7.** If, as a consequence of a court judgment or allegation of patent infringement or for any other reason (not limited to patent issues), conditions are imposed on you (whether by court order, agreement or otherwise) that contradict the conditions of this License, they do not excuse you from the conditions of this License. If you cannot distribute so as to satisfy simultaneously your obligations under this License and any other pertinent obligations, then as a consequence you may not distribute the Program at all. For example, if a patent license would not permit royalty-free

redistribution of the Program by all those who receive copies directly or indirectly through you, then the only way you could satisfy both it and this License would be to refrain entirely from distribution of the Program.

If any portion of this section is held invalid or unenforceable under any particular circumstance, the balance of the section is intended to apply and the section as a whole is intended to apply in other circumstances.

It is not the purpose of this section to induce you to infringe any patents or other property right claims or to contest validity of any such claims; this section has the sole purpose of protecting the integrity of the free software distribution system, which is implemented by public license practices. Many people have made generous contributions to the wide range of software distributed through that system in reliance on consistent application of that system; it is up to the author/donor to decide if he or she is willing to distribute software through any other system and a licensee cannot impose that choice.

This section is intended to make thoroughly clear what is believed to be a consequence of the rest of this License.

**8.** If the distribution and/or use of the Program is restricted in certain countries either by patents or by copyrighted interfaces, the

original copyright holder who places the Program under this License may add an explicit geographical distribution limitation excluding those countries, so that distribution is permitted only in or among countries not thus excluded. In such case, this License incorporates the limitation as if written in the body of this License.

**9.** The Free Software Foundation may publish revised and/or new versions of the General Public License from time to time. Such new versions will be similar in spirit to the present version, but may differ in detail to address new problems or concerns.

Each version is given a distinguishing version number. If the Program specifies a version number of this License which applies to it and "any later version", you have the option of following the terms and conditions either of that version or of any later version published by the Free Software Foundation. If the Program does not specify a version number of this License, you may choose any version ever published by the Free Software Foundation.

**10.** If you wish to incorporate parts of the Program into other free programs whose distribution conditions are different, write to the author to ask for permission. For software which is copyrighted by the Free Software Foundation, write to the Free Software Foundation; we sometimes make exceptions for this. Our decision will be guided by the two goals of preserving the free status of all

derivatives of our free software and of promoting the sharing and reuse of software generally.

## **NO WARRANTY**

**11.** BECAUSE THE PROGRAM IS LICENSED FREE OF CHARGE, THERE IS NO WARRANTY FOR THE PROGRAM, TO THE EXTENT PERMITTED BY APPLICABLE LAW. EXCEPT WHEN OTHERWISE STATED IN WRITING THE COPYRIGHT HOLDERS AND/OR OTHER PARTIES PROVIDE THE PROGRAM "AS IS" WITHOUT WARRANTY OF ANY KIND, EITHER EXPRESSED OR IMPLIED, INCLUDING, BUT NOT LIMITED TO, THE IMPLIED WARRANTIES OF MERCHANTABILITY AND FITNESS FOR A PARTICULAR PURPOSE. THE ENTIRE RISK AS TO THE QUALITY AND PERFORMANCE OF THE PROGRAM IS WITH YOU. SHOULD THE PROGRAM PROVE DEFECTIVE, YOU ASSUME THE COST OF ALL NECESSARY SERVICING, REPAIR OR CORRECTION.

**12.** IN NO EVENT UNLESS REQUIRED BY APPLICABLE LAW OR AGREED TO IN WRITING WILL ANY COPYRIGHT HOLDER, OR ANY OTHER PARTY WHO MAY MODIFY AND/OR REDISTRIBUTE THE PROGRAM AS PERMITTED ABOVE, BE LIABLE TO YOU FOR DAMAGES, INCLUDING ANY GENERAL,



SPECIAL, INCIDENTAL OR CONSEQUENTIAL DAMAGES ARISING OUT OF THE USE OR INABILITY TO USE THE PROGRAM (INCLUDING BUT NOT LIMITED TO LOSS OF DATA OR DATA BEING RENDERED INACCURATE OR LOSSES SUSTAINED BY YOU OR THIRD PARTIES OR A FAILURE OF THE PROGRAM TO OPERATE WITH ANY OTHER PROGRAMS), EVEN IF SUCH HOLDER OR OTHER PARTY HAS BEEN ADVISED OF THE POSSIBILITY OF SUCH DAMAGES.

## **END OF TERMS AND CONDITIONS**

### **How to Apply These Terms to Your New Programs**

If you develop a new program, and you want it to be of the greatest possible use to the public, the best way to achieve this is to make it free software which everyone can redistribute and change under these terms.

To do so, attach the following notices to the program. It is safest to attach them to the start of each source file to most effectively convey the exclusion of warranty; and each file should have at least the "copyright" line and a pointer to where the full notice is found.

```
one line to give the program's name and an idea of what it does.  
Copyright (C) yyyy name of author
```

This program is free software; you can redistribute it and/or modify it under the terms of the GNU General Public License as published by the Free Software Foundation; either version 2 of the License, or (at your option) any later version.

This program is distributed in the hope that it will be useful, but WITHOUT ANY WARRANTY; without even the implied warranty of MERCHANTABILITY or FITNESS FOR A PARTICULAR PURPOSE. See the GNU General Public License for more details.

You should have received a copy of the GNU General Public License along with this program; if not, write to the Free Software Foundation, Inc., 51 Franklin Street, Fifth Floor, Boston, MA 02110-1301, USA.

**Also add information on how to contact you by electronic and paper mail.**

**If the program is interactive, make it output a short notice like this when it starts in an interactive mode:**

```
Gnomovision version 69, Copyright (C) year name of author
Gnomovision comes with ABSOLUTELY NO WARRANTY; for details
type `show w'. This is free software, and you are welcome
to redistribute it under certain conditions; type `show c'
for details.
```

**The hypothetical commands ``show w'` and ``show c'` should show the appropriate parts of the General Public License. Of course, the commands you use may be called something other than ``show w'` and ``show c'`; they could even be mouse-clicks or menu items--whatever suits your program.**

**You should also get your employer (if you work as a programmer) or your school, if any, to sign a "copyright disclaimer" for the program, if necessary. Here is a sample; alter the names:**

Yoyodyne, Inc., hereby disclaims all copyright interest in the program `Gnomovision' (which makes passes at compilers) written by James Hacker.

signature of Ty Coon, 1 April 1989  
Ty Coon, President of Vice

This General Public License does not permit incorporating your program into proprietary programs. If your program is a subroutine library, you may consider it more useful to permit linking proprietary applications with the library. If this is what you want to do, use the [GNU Lesser General Public License](#) instead of this License.

## Notification of Compliance

---

### Europe - EU Declaration of Conformity



For complete DoC please visit  
<http://global.level1.com/downloads.php?action=init>

### GPL License Agreement

GPL may be included in this product, to view the GPL license agreement goes to  
<http://download.level1.com/level1/gpl/GPL.pdf>

For GNU General Public License (GPL) related information, please visit  
<http://global.level1.com/downloads.php?action=init>

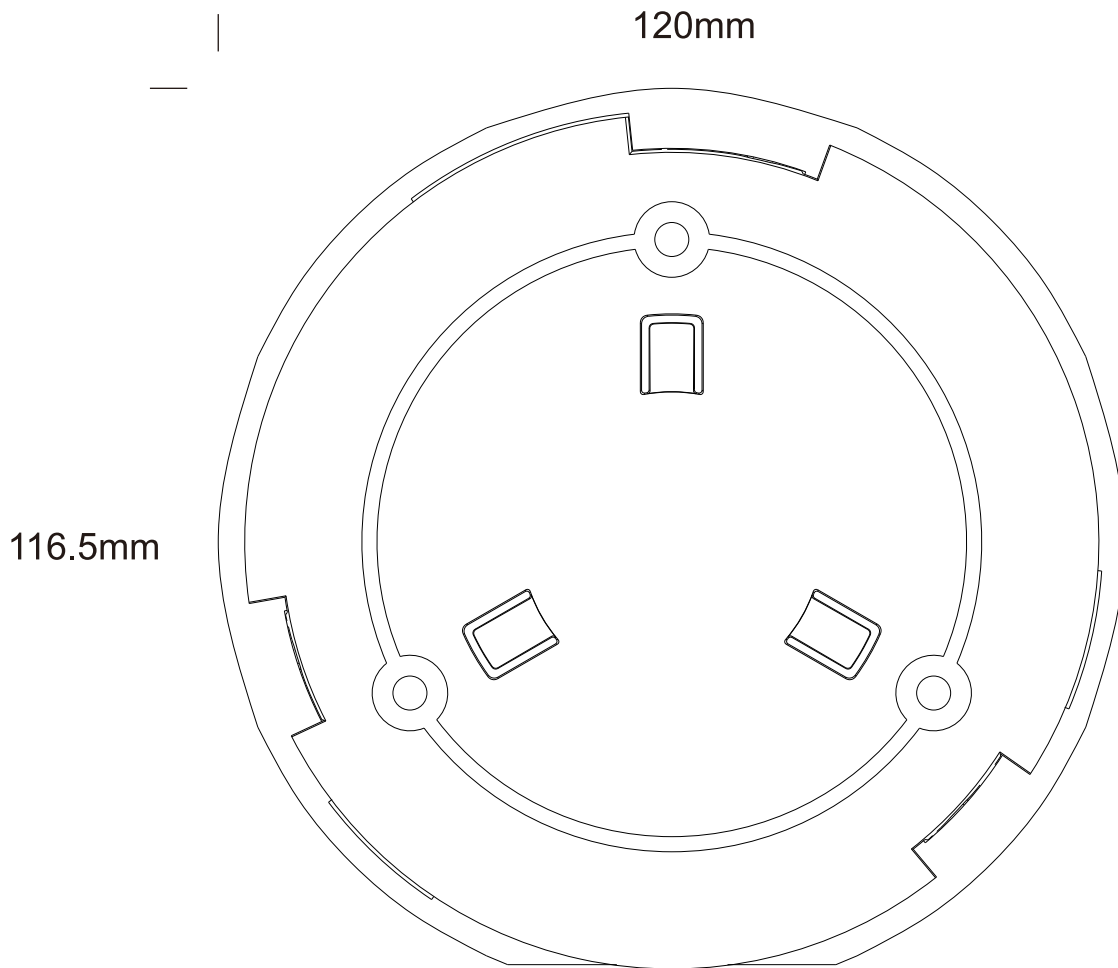

scale 1:1