

■ Bases for Freestanding Enclosures DS, DSZ, DSP and DSS



DSOT1280



DSOT1280



DSOF1280

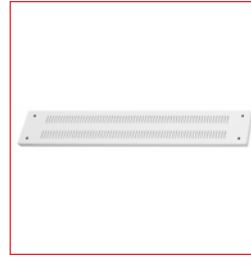

DSOF1281



DSOF1282



DSOF1283



DSOS1200

■ SCHRACK-INFO

Universal bases for freestanding enclosures are a modular system made up of pairs of side-profiles for various depths (600, 800, 900, 1.000 and 1.200mm) and front/rear covers for various widths (600 and 800mm). The main part are the pairs of side profiles DSOT/DSSOT which carry enclosures with load up to 400/1.300kg. Cable entry from the side is possible by knocking out the break-out blank covers of the side profiles. The bases are completed by individually packed front/rear-covers. Four front/rear-covers are available and can be chosen: Standard blanking covers, perforated covers cable entry covers with brush and perforated covers with dust filter. All covers come supplied with assembly materials. The base is 120mm high. Color RAL 7035. The stabilizer set is screwed onto the base in the front and is used to prevent the enclosure from tipping over. Fits to all dimensions of bases.



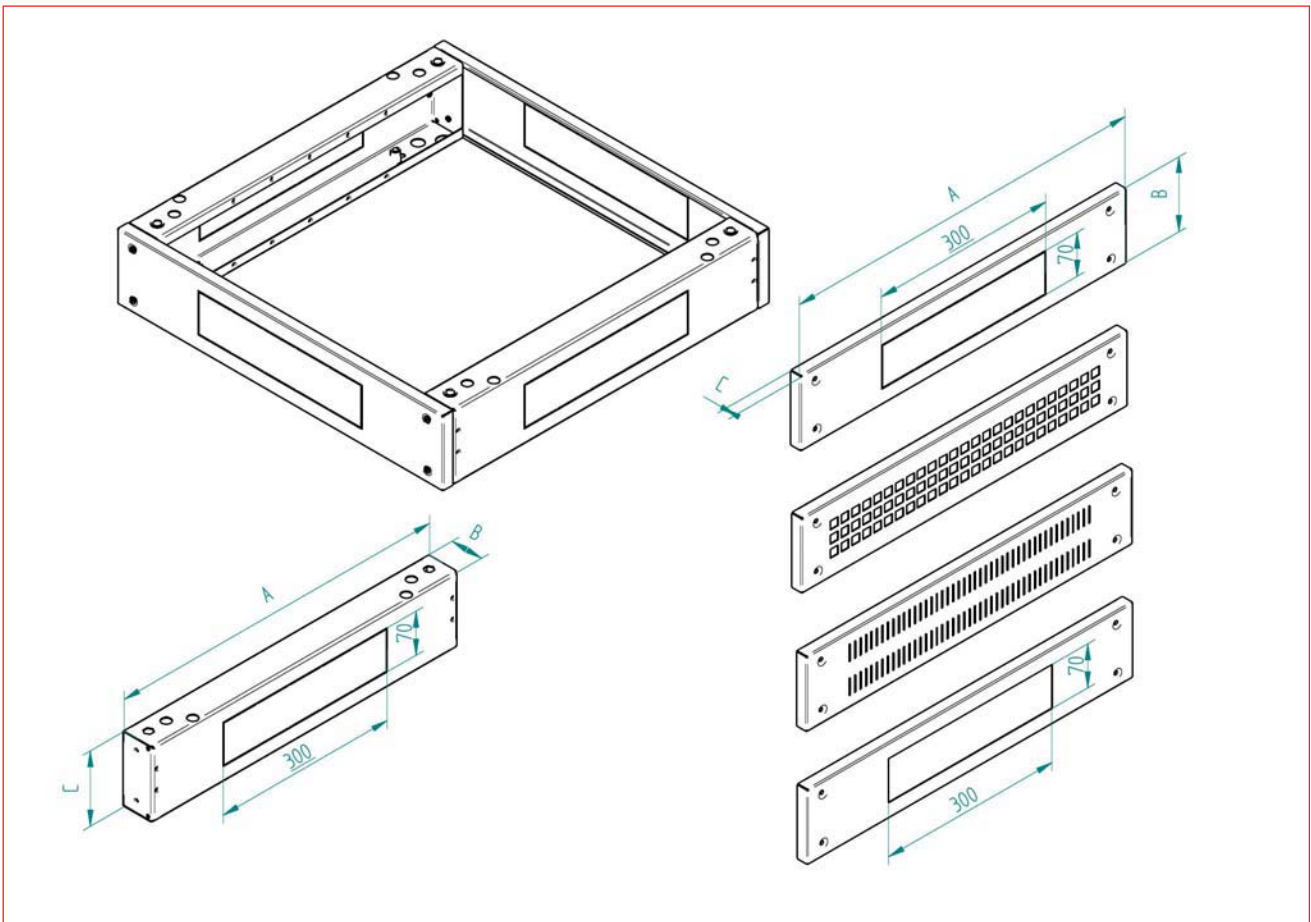













■ DIMENSIONS



Free-standing data enclosures 19"

▀ Bases for Freestanding Enclosures DS, DSZ, DSP and DSS

	A / mm	B / mm	C / mm
DSOT1240	360	55	120
DSOT1260	560	55	120
DSOT1280	760	55	120
DSOT1290	860	55	120
DSOT1210	960	55	120
DSOT1220	1160	55	120
DSSOT1280	760	55	120
DSSOT1210	960	55	120
DSOF1260	600	120	20
DSOF1261	600	120	20
DSOF1262	600	120	20
DSOF1263	600	120	20
DSOF1280	800	120	20
DSOF1281	800	120	20
DSOF1282	800	120	20
DSOF1283	800	120	20

DESCRIPTION	AVAILABLE	ORDER NO.
Base, Pairs of side-profiles for Data-Enclosures DS, DSZ and DSP		
Base side-profile-pair, D=400, H=120 for DS/DSZ/DSP, RAL7035		DSOT1240
Base side-profile-pair, D=600, H=120 for DS/DSZ/DSP, RAL7035		DSOT1260
Base side-profile-pair, D=800, H=120 for DS/DSZ/DSP, RAL7035		DSOT1280
Base side-profile-pair, D=900, H=120 for DS/DSZ/DSP, RAL7035		DSOT1290
Base side-profile-pair, D=1000, H=120 for DS/DSZ/DSP, RAL7035		DSOT1210
Base side-profile-pair, D=1200, H=120 for DS/DSZ/DSP, RAL7035		DSOT1220
Base, Pairs of side-profiles for Server-Enclosures DSS		
Base side-profile-pair, D= 800mm, H=120mm, for DSS, Max. Load = 1.300kg, RAL7035		DSSOT1280
Base side-profile-pair, D=1.000mm, H=120mm, for DSS, Max. Load = 1.300kg, RAL7035		DSSOT1210
Base, Front-/Rear-panels for Freestanding Enclosures DS, DSZ, DSP and DSS, W=600mm		
Base front-/rear-cover, W=600, H=120 for DS/DSZ/DSS/DSP, RAL7035		DSOF1260
Base front-/rear-cover perforated, W=600, H=120 for DS/DSZ/DSS/DSP, RAL7035		DSOF1261
Base front-/rear-cover with brush, W=600, H=120 for DS/DSZ/DSS/DSP, RAL7035		DSOF1262
Base front-/rear-cover perforated+filter, W=600, H=120 for DS/DSZ/DSS/DSP, RAL7035		DSOF1263
Base, Front-/Rear-panels for Freestanding Enclosures DS, DSZ, DSP and DSS, W=800mm		
Base front-/rear-cover, W=800, H=120 for DS/DSZ/DSS/DSP, RAL7035		DSOF1280
Base front-/rear-cover perforated, W=800, H=120 for DS/DSZ/DSS/DSP, RAL7035		DSOF1281
Base front-/rear-cover with brush, W=800, H=120 for DS/DSZ/DSS/DSP, RAL7035		DSOF1282
Base front-/rear-cover perforated+filter, W=800, H=120 for DS/DSZ/DSS/DSP-enclosures, RAL7035		DSOF1283
Stabilizer-Set for Data-Enclosures DS, DSZ and DSP		
Stabilizer for mounting to base of DS/DSZ/DSI-enclosure, RAL7035		DSOS1200