

## Shelves Fixed Heavy Duty 19"



DFSS4865-A

### SCHRACK-INFO

Shelves are used for equipment that has no 19"-installation possibility. To increase stability and maximum possible load, we recommend 4-point (front and rear) fixing of the shelves to the 19"-vertical rails. Rear 19"-mounting brackets are included in delivery. These heavy duty shelves offer a maximum load of 150 kg. Thus, they are used to place servers, UPS, battery packs or other very heavy equipment on it.

- Powder coated steel sheet
- Color: RAL7035 (lightgrey).
- Perforated for optimized air-flow inside the cabinet.
- High load capability of 150 kg.
- Used height: 1U
- 100% of space between 19"-vertical rails can be used -> Width for equipment: 450mm.
- Flexible adjustable in depth:

- Front side of shelf can be installed before or behind front 19"-vertical rails.



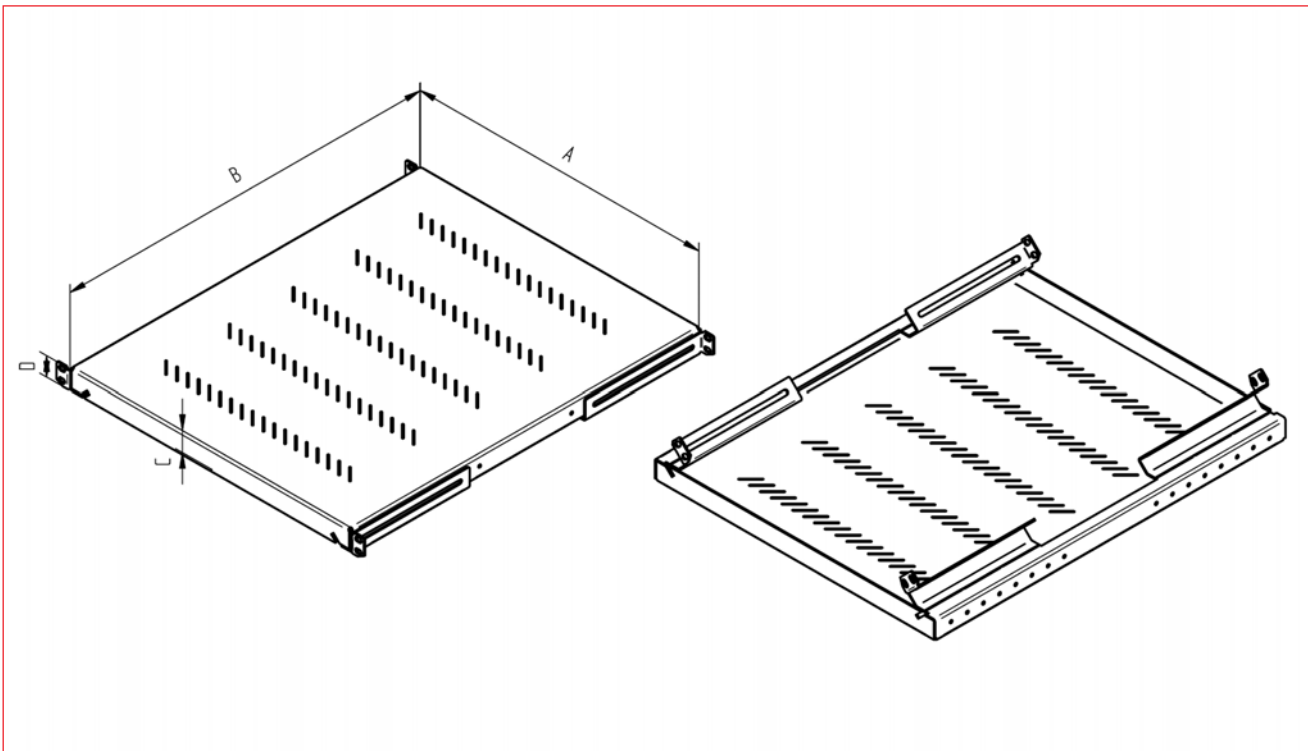

- Back side of shelf can be installed behind or before rear 19"-vertical rails.

- Included assembly materials: 8x cage nuts, bolts and washers M6

### DIMENSIONS

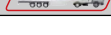

	A / mm	B / mm	C / mm	D / mm	Mounting brackets included	Maximum load / kg
DFSS4845-A	450	440	30	1U	4	150
DFSS4855-A	550	440	30	1U	4	150
DFSS4865-A	650	440	30	1U	4	150
DFSS4875-A	750	440	30	1U	4	150
DFSS4885-A	850	440	30	1U	4	150
DFSS4895-A	950	440	30	1U	4	150

DESCRIPTION	AVAILABLE	ORDER NO.
19" Shelf Fix, Heavy Duty up to 150kg Load, D=450mm, 1U, RAL7035		<b>DFSS4845-A</b>
19" Shelf Fix, Heavy Duty up to 150kg Load, D=550mm, 1U, RAL7035		<b>DFSS4855-A</b>
19" Shelf Fix, Heavy Duty up to 150kg Load, D=650mm, 1U, RAL7035		<b>DFSS4865-A</b>
19" Shelf Fix, Heavy Duty up to 150kg Load, D=750mm, 1U, RAL7035		<b>DFSS4875-A</b>
19" Shelf Fix, Heavy Duty up to 150kg Load, D=850mm, 1U, RAL7035		<b>DFSS4885-A</b>
19" Shelf Fix, Heavy Duty up to 150kg Load, D=950mm, 1U, RAL7035		<b>DFSS4895-A</b>



Order no. blue: on stock, usually ready for delivery on the day of order!