

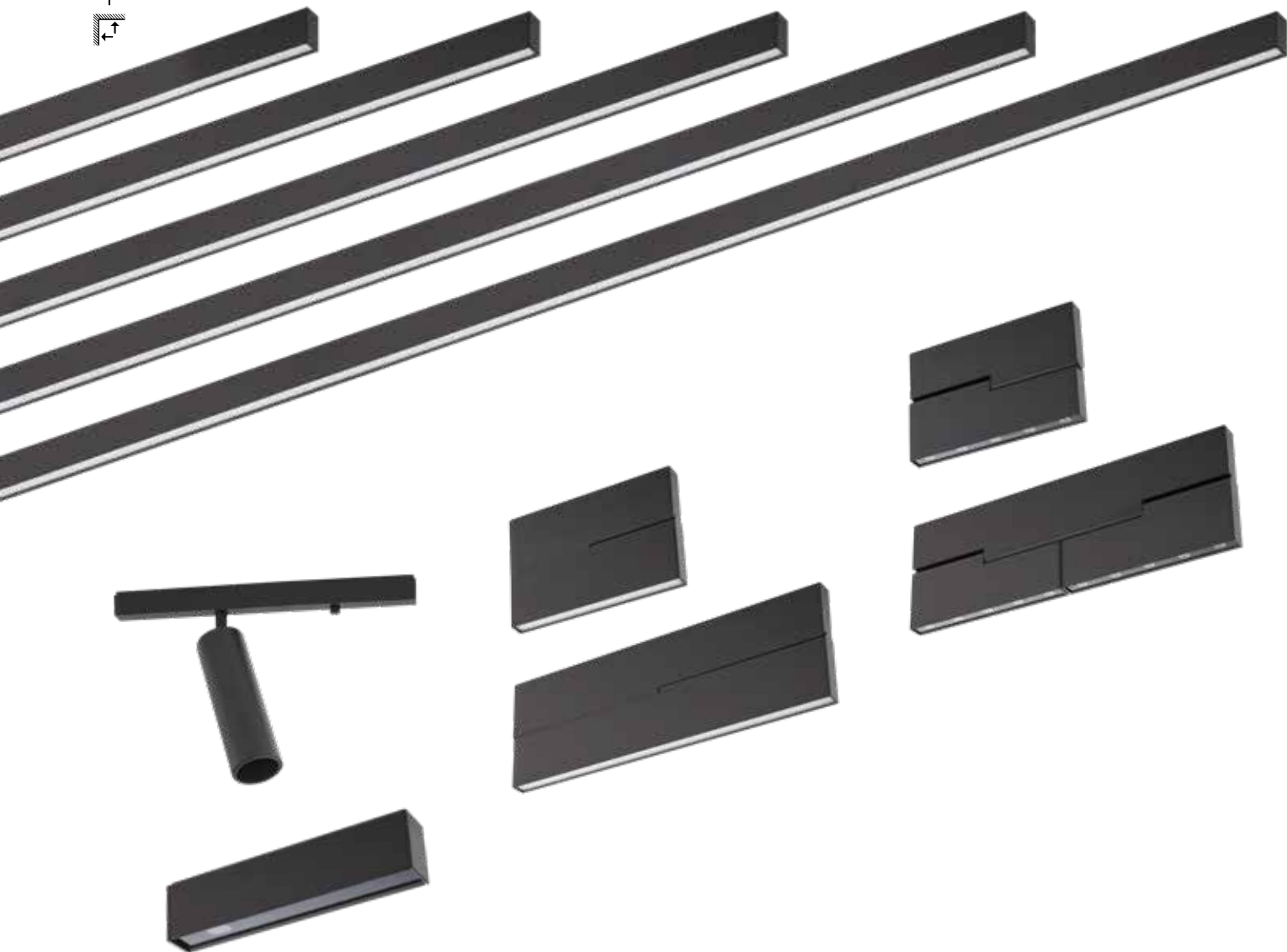

## XTRIM S RECESSED/SURFACE



### EN

Light fittings for the XTRIM S RECESSED and XTRIM S SURFACE systems.

Available as linear luminaires with opal diffusers or reflectors, fixed or adjustable and as projectors.

All these light fittings are equipped with magnetic fastening system.

### RO

Corpuri de iluminat pentru sistemele XTRIM S RECESSED și XTRIM S SURFACE.

Disponibile în versiuni de corpuri liniare, cu dispersoare opale sau reflectoare, fixe sau ajustabile și proiectoare.

Toate aceste corpuri de iluminat sunt dotate cu sistem magnetic de fixare.

### IT

Apparecchi di illuminazione per sistemi XTRIM SMALL RECESSED e XTRIM SMALL SURFACE.

Sono disponibili apparecchi lineari con diffusori opalini o riflettori, apparecchi fissi o orientabili e proiettori.

Tutti questi apparecchi sono dotati di sistema di fissaggio magnetico.

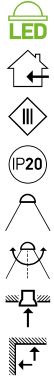

## LINEAR LIGHT FITTINGS

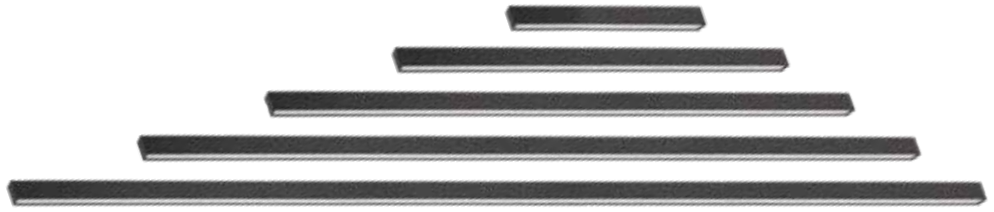
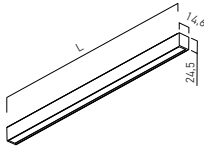

Code	Finishing	LED type	Power	Input voltage	Luminous flux	LED color temperature	CRI	Optics	Length	Weight
STMRS01WW OP	BK	SMD 2835 EDISON	10W	24V DC	467 lm	3000K	80	Large	300 mm	0.12 kg
STMRS02WW OP	BK	SMD 2835 EDISON	20W	24V DC	934 lm	3000K	80	Large	600 mm	0.25 kg
STMRS03WW OP	BK	SMD 2835 EDISON	30W	24V DC	1403 lm	3000K	80	Large	900 mm	0.37 kg
STMRS04WW OP	BK	SMD 2835 EDISON	40W	24V DC	1868 lm	3000K	80	Large	1190 mm	0.47 kg
STMRS05WW OP	BK	SMD 2835 EDISON	50W	24V DC	2337 lm	3000K	80	Large	1490 mm	0.60 kg

Linear light fittings, for installation in the profiles of XTRIM S RECESSED and XTRIM S SURFACE systems, equipped with SMD LED module, opal diffuser and magnetic fastening system.  
Housing of extruded aluminum profile, electrostatically painted.  
Opal diffuser of polystyrene.

Corpuri de iluminat liniare, pentru montajul în profilele sistemelor XTRIM S RECESSED și XTRIM S SURFACE, echipate cu modul cu LED-uri SMD, dispersor opal și sistem magnetic de fixare.  
Structură din profil de aluminiu extrudat, vopsit în câmp electrostatic. Dispersor opal din polistiren.

Apparecchi lineari, per l'installazione sui profili dei sistemi XTRIM S RECESSED e XTRIM S SURFACE, dotati di modulo a LED SMD, diffusore opalino e sistema di fissaggio magnetico.  
Corpo in profilo estruso di alluminio verniciato in campo elettrostatico. Diffusore opalino in polistirene.

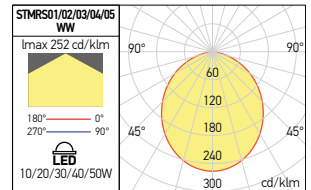

## FIX SPOTLIGHT

FINISHING AVAILABLE

**BK**

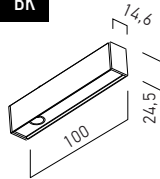

Code	Finishing	LED type	Power	Input voltage	Luminous flux	LED color temperature	CRI	Optics	Weight
STMRS31WW SP	BK	POWER LED OSRAM	3W	24V DC	138 lm	3000K	90	20°	0.30 kg

Fix spotlight for installation in the profiles of XTRIM S RECESSED and XTRIM S SURFACE systems, equipped with power LED and magnetic fastening system. Housing of extruded aluminum profile, electrostatically painted.

Spot fix pentru montajul în profilele sistemelor XTRIM S RECESSED și XTRIM S SURFACE, echipat cu LED de putere și sistem magnetic de fixare.  
Corp din profil de aluminiu extrudat, vopsit în câmp electrostatic.

Faretto fisso per l'installazione su profili dei sistemi XTRIM S RECESSED e XTRIM S SURFACE, dotato di LED di potenza e sistema di fissaggio magnetico. Corpo in profilo estruso di alluminio verniciato in campo elettrostatico.

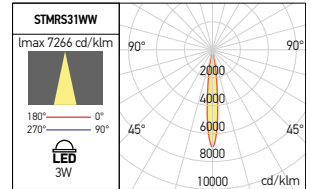

## ADJUSTABLE MINI PROJECTOR

FINISHING AVAILABLE

**BK**

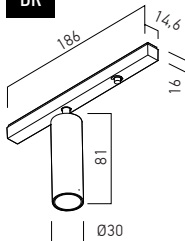

Code	Finishing	LED type	Power	Input voltage	Luminous flux	LED color temperature	CRI	Optics	Weight
STMRS41WW SP	BK	POWER LED CREE	6.5W	24V DC	427 lm	3000K	90	14°	0.15 kg

Adjustable and dimmable mini projector for installation in the profiles of XTRIM S RECESSED and XTRIM S SURFACE systems, equipped with power LED, satin diffuser of polystyrene and magnetic fastening system. Housing of extruded aluminum profile, electrostatically painted.

Mini proiector orientabil și dimabil pentru montajul în profilele sistemelor XTRIM S RECESSED și XTRIM S SURFACE, echipat cu LED de putere, dispersor satinat din polistiren și sistem magnetic de fixare. Corp din profil de aluminiu extrudat, vopsit în câmp electrostatic.

Mini proiettore orientabile e dimmerabile per l'installazione su profili dei sistemi XTRIM S RECESSED e XTRIM S SURFACE, dotato di LED di potenza, diffusore satinato in polistirolo e sistema di fissaggio magnetico. Corpo in profilo estruso di alluminio verniciato in campo elettrostatico.

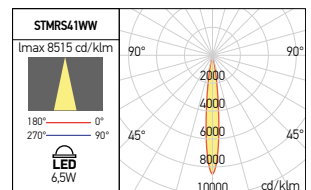

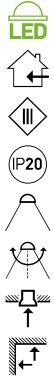

## ADJUSTABLE LINEAR LIGHT FITTINGS

FINISHING AVAILABLE

**BK**

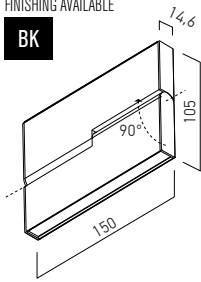

Code	Finishing	LED type	Power	Input voltage	Luminous flux	LED color temperature	CRI	Optics	Weight
STMRS11WW OP	BK	SMD 2835 EDISON	5W	24V DC	228 lm	3000K	80	Large	0,32 kg

FINISHING AVAILABLE

**BK**

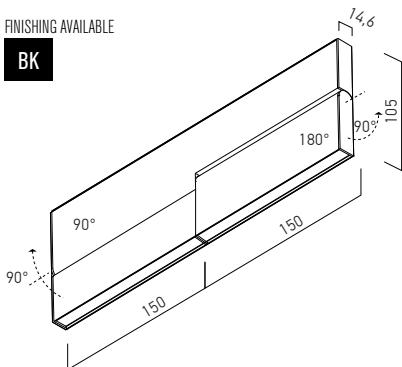

Code	Finishing	LED type	Power	Input voltage	Luminous flux	LED color temperature	CRI	Optics	Weight
STMRS12WW OP	BK	SMD 2835 EDISON	10W	24V DC	456 lm	3000K	80	Large	0,61 kg

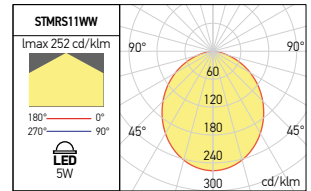

Adjustable linear light fittings, for installation in the profiles of XTRIM S RECESSED and XTRIM S SURFACE systems, equipped with SMD LED module, opal diffuser and magnetic fastening system. Housing of extruded aluminum profile, electrostatically painted. Opal diffuser of polystyrene.

Corpuri de iluminat liniare orientabile, pentru montajul în profilele sistemelor XTRIM S RECESSED și XTRIM S SURFACE, echipate cu modul cu LED-uri SMD, dispersor opal și sistem magnetic de fixare. Corp din profil de aluminiu extrudat, vopsit în câmp electrostatic. Dispersor opal din polistiren.

Apparecchi lineari orientabili, per l'installazione su profili dei sistemi XTRIM S RECESSED e XTRIM S SURFACE, dotati di modulo a LED SMD, diffusore opalino e sistema di fissaggio magnetico. Corpo in profilo estruso di alluminio verniciato in campo elettrostatico. Diffusore opalino in polistirene.

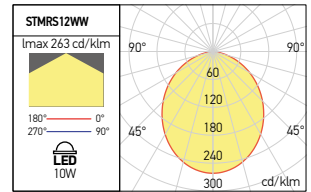

## ADJUSTABLE LINEAR PROJECTORS

FINISHING AVAILABLE

**BK**

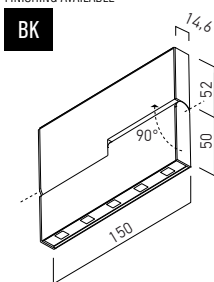

Code	Finishing	LED type	Power	Input voltage	Luminous flux	LED color temperature	CRI	Optics	Weight
STMRS21WW SP	BK	POWER LED OSRAM	5,3W	24V DC	424 lm	3000K	90	20°	0,50 kg

FINISHING AVAILABLE

**BK**

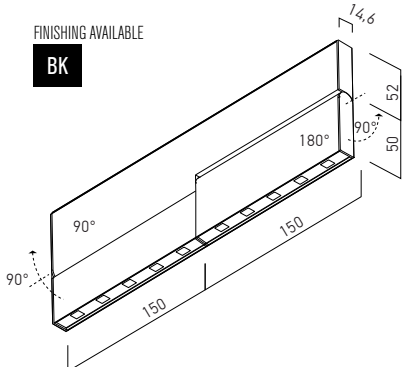

Code	Finishing	LED type	Power	Input voltage	Luminous flux	LED color temperature	CRI	Optics	Weight
STMRS22WW SP	BK	POWER LED OSRAM	10,6W	24V DC	848 lm	3000K	90	20°	1,00 kg

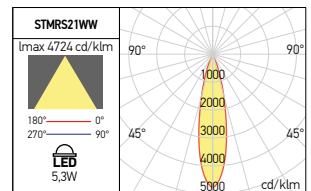

Adjustable linear projectors, for installation in the profiles of XTRIM S RECESSED and XTRIM S SURFACE systems, equipped with power LEDs, FRESNEL lenses in PMMA and magnetic fastening system. Housing of extruded aluminum profile, electrostatically painted.

Proiectoare liniare orientabile, pentru montajul în profilele sistemelor XTRIM S RECESSED și XTRIM S SURFACE, echipate cu LED-uri de putere, lentile FRESNEL din PMMA și sistem magnetic de fixare. Corp din profil de aluminiu extrudat, vopsit în câmp electrostatic.

Proiettori lineari orientabili per installazione su profili dei sistemi XTRIM S RECESSED e XTRIM S SURFACE, dotati di LED di potenza, lenti FRESNEL in PMMA e sistema di fissaggio magnetico. Corpo in profilo estruso di alluminio verniciato in campo elettrostatico.

