

# xtrim s recessed/surface

**5 YEARS  
WARRANTY**

## LIGHT FITTINGS FOR XTRIM S RECESSED AND SURFACE



### EN

Light fittings for the XTRIM S RECESSED and XTRIM S SURFACE systems.

Available as linear luminaires with opal diffusers or reflectors, fixed or adjustable and as projectors.

All these light fittings are equipped with magnetic fastening system.

### RO

Corpuri de iluminat pentru sistemele XTRIM S RECESSED și XTRIM S SURFACE.

Disponibile în versiuni de corpuri liniare, cu dispersoare opale sau reflectoare, fixe sau orientabile și proiectoare.

Toate aceste corpuri de iluminat sunt dotate cu sistem magnetic de fixare.

### IT

Apparecchi di illuminazione per sistemi XTRIM S RECESSED e XTRIM S SURFACE.

Sono disponibili apparecchi lineari con diffusori opalini o riflettori, apparecchi fissi o orientabili e proiettori.

Tutti questi apparecchi sono dotati di sistema di fissaggio magnetico.

### LINEAR LIGHT FITTINGS

FINISHING AVAILABLE

**BK**

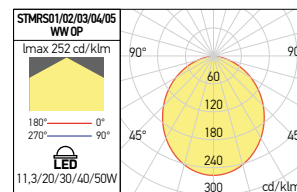
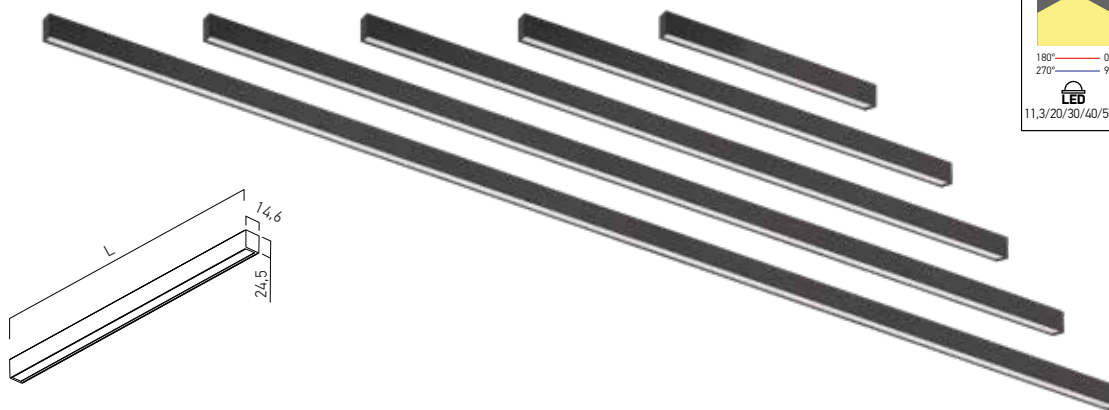

Code	Finishing	LED type	Power	Input voltage	LED Flux	System Flux	CCT	CRI	Optics	Length (L)	Weight
STMRS01WW OP	BK	SMD 2835 HONGLI	11.3W	48V DC	720 lm	456 lm	3000K	80	Large	300 mm	0.12 kg
STMRS02WW OP	BK	SMD 2835 HONGLI	20W	48V DC	1440 lm	912 lm	3000K	80	Large	600 mm	0.25 kg
STMRS03WW OP	BK	SMD 2835 HONGLI	30W	48V DC	2160 lm	1368 lm	3000K	80	Large	900 mm	0.37 kg
● STMRS04WW OP	BK	SMD 2835 HONGLI	40W	48V DC	2880 lm	1824 lm	3000K	80	Large	1190 mm	0.47 kg
STMRS05WW OP	BK	SMD 2835 HONGLI	50W	48V DC	3600 lm	2280 lm	3000K	80	Large	1490 mm	0.60 kg

● ORDERED UPON REQUEST / DISPONIBIL DOAR LA COMANDĂ / DISPONIBILE SOLO SU ORDINAZIONE

Linear light fittings, for installation in the profiles of XTRIM S RECESSED and XTRIM S SURFACE systems, equipped with SMD LED module, opal diffusers of polystyrene and magnetic fastening system.

Housing of extruded aluminum profile, electrostatically painted.

Corpuri de iluminat liniare, pentru montajul în profilele sistemelor XTRIM S RECESSED și XTRIM S SURFACE, echipate cu modul cu LED-uri SMD, dispersoare opale din polistiren și sistem magnetic de fixare.

Structură din profil de aluminiu extrudat, vopsit în câmp electrostatic.

Apparecchi lineari, per l'installazione sui profili dei sistemi XTRIM S RECESSED e XTRIM S SURFACE, dotati di modulo a LED SMD, diffusori opalini in poliestere e sistema di fissaggio magnetico.

Corpo in profilo estruso di alluminio verniciato in campo elettrostatico.

## FIX SPOTLIGHT

FINISHING AVAILABLE

BK

### STMRS31

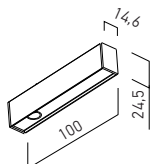

### STMRS33

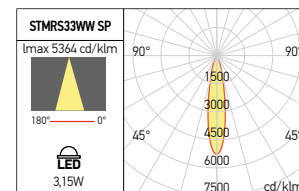
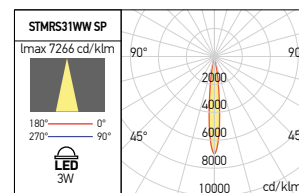
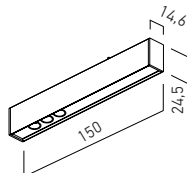

Code	Finishing	LED type	Power	Input voltage	LED Flux	System Flux	CCT	CRI	Optics	Weight
STMRS31WW SP	BK	POWER LED OSRAM	3W	48V DC	330 lm	138 lm	3000K	90	20°	0,30 kg
STMRS33WW SP	BK	POWER LED OSRAM	3,15W	48V DC	330 lm	192 lm	3000K	90	18°	0,70 kg

Fix spotlight for installation in the profiles of XTRIM S RECESSED and XTRIM S SURFACE systems, equipped with power LED and magnetic fastening system. Housing of extruded aluminum profile, electrostatically painted. Optical system UGR<10.

Spot fix pentru montajul în profilele sistemelor XTRIM S RECESSED și XTRIM S SURFACE, echipat cu LED de putere și sistem magnetic de fixare. Corp din profil de aluminiu extrudat, vopsit în câmp electrostatic. Sistem optic UGR<10.

Faretto fisso per l'installazione su profili dei sistemi XTRIM S RECESSED e XTRIM S SURFACE, dotato di LED di potenza e sistema di fissaggio magnetico. Corpo in profilo estruso di alluminio verniciato in campo elettrostatico. Sistema ottico UGR<10.

## ADJUSTABLE MINI PROJECTOR

FINISHING AVAILABLE

BK

### STMRS41

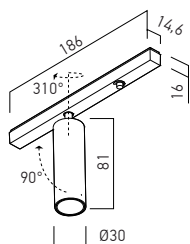

FINISHING AVAILABLE

BK

### STMRS42

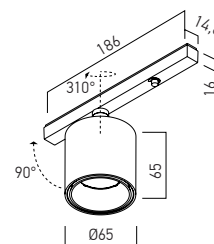

Code	Finishing	LED type	Power	Input voltage	LED Flux	System Flux	CCT	CRI	Optics	Weight
STMRS41WW SP	BK	POWER LED CREE	8,4W	48V DC	690 lm	427 lm	3000K	90	14°	0,15 kg
STMRS42WW SP	BK	POWER LED CREE	8,2W	48V DC	690 lm	466 lm	3000K	90	6°	0,28 kg

Adjustable and dimmable mini projector for installation in the profiles of XTRIM S RECESSED and XTRIM S SURFACE systems, equipped with power LED, satin diffuser of polystyrene and magnetic fastening system. Optical system UGR<16. Housing of extruded aluminum profile, electrostatically painted.

Mini proiector orientabil și dimabil pentru montajul în profilele sistemelor XTRIM S RECESSED și XTRIM S SURFACE, echipat cu LED de putere, dispersor satinat din polistiren și sistem magnetic de fixare. Sistem optic UGR<16. Corp din profil de aluminiu extrudat, vopsit în câmp electrostatic.

Mini proiettore orientabile e dimmerabile per l'installazione su profili dei sistemi XTRIM S RECESSED e XTRIM S SURFACE, dotato di LED di potenza, diffusore satinato in polistirene e sistema di fissaggio magnetico. Sistema ottico UGR<16. Corpo in profilo estruso di alluminio verniciato in campo elettrostatico.

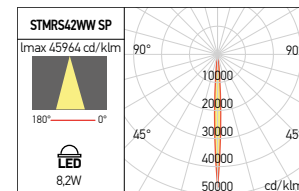
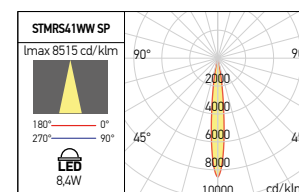

### DECORATIVE SPHERICAL LIGHT FITTINGS

FINISHING AVAILABLE

**BK**

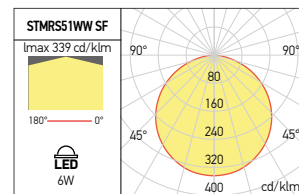
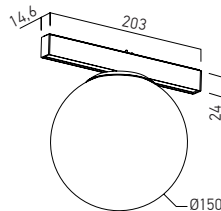

Code	Finishing	LED type	Power	Input voltage	LED Flux	System Flux	CCT	CRI	Optics	Weight
<b>STMRS11WW SF</b>	BK	COB LUMINUS	6W	48V DC	650 lm	421 lm	3000K	90	Large	0.52 kg

Decorative light fitting with spherical shape, for installation in the profiles of XTRIM S RECESSED and XTRIM S SURFACE systems, equipped with power LED, warm white color temperature and magnetic fastening system.

Corp de iluminat decorativ cu formă sferică, pentru montajul în profilele sistemelor XTRIM S RECESSED și XTRIM S SURFACE, echipat cu LED de putere, temperatură de culoare alb cald și sistem magnetic de fixare.

Apparecchio decorativo sferico, per l'installazione nei profili dei sistemi XTRIM S RECESSED e XTRIM S SURFACE, dotato di LED di potenza, temperatura di colore bianco caldo e sistema di fissaggio magnetico.

### ADJUSTABLE LINEAR LIGHT FITTINGS

Adjustable linear light fittings, for installation in the profiles of XTRIM S RECESSED and XTRIM S SURFACE systems, equipped with SMD LEDs modules, opal diffusers of polystyrene and magnetic fastening systems. Housing of extruded aluminum profile, electrostatically painted.

Corpuri de iluminat liniare orientabile, pentru montajul în profilele sistemelor XTRIM S RECESSED și XTRIM S SURFACE, echipate cu module cu LED-uri SMD, dispersoare opale din polistiren și sisteme magnetice de fixare. Corp din profil de aluminiu extrudat, vopsit în câmp electrostatic.

Apparecchi lineari orientabili, per l'installazione su profili dei sistemi XTRIM S RECESSED e XTRIM S SURFACE, dotati di moduli a LED SMD, diffusori opalini in polistirene e sistemi di fissaggio magnetico. Corpo in profilo estruso di alluminio verniciato in campo elettrostatico.

FINISHING AVAILABLE

**BK**

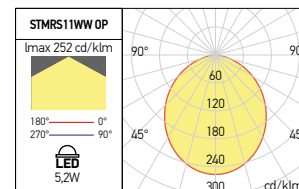
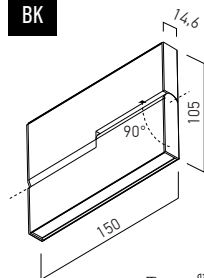

Code	Finishing	LED type	Power	Input voltage	LED Flux	System Flux	CCT	CRI	Optics	Weight
<b>STMRS11WW OP</b>	BK	SMD 2835 HONGLI	5,2W	48V DC	275 lm	206 lm	3000K	80	Large	0.32 kg

FINISHING AVAILABLE

**BK**

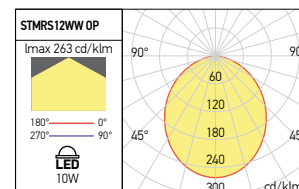
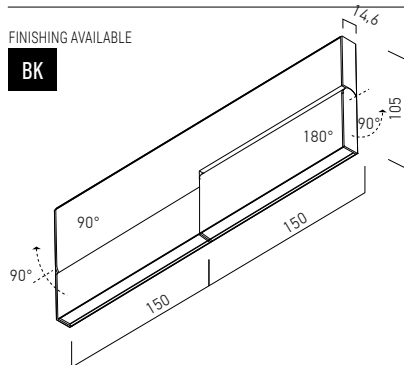

Code	Finishing	LED type	Power	Input voltage	LED Flux	System Flux	CCT	CRI	Optics	Weight
<b>STMRS12WW OP</b>	BK	SMD 2835 HONGLI	10W	48V DC	550 lm	456 lm	3000K	80	Large	0.61 kg

### ADJUSTABLE LINEAR PROJECTORS

Adjustable linear projectors, for installation in the profiles of XTRIM S RECESSED and XTRIM S SURFACE systems, equipped with power LEDs, FRESNEL lenses in PMMA and magnetic fastening system.

Optical system UGR<16.

Housing of extruded aluminum profile, electrostatically painted.

Proiectoare liniare orientabile, pentru montajul în profilele sistemelor XTRIM S RECESSED și XTRIM S SURFACE, echipate cu LED-uri de putere, lentile FRESNEL din PMMA și sistem magnetic de fixare.

Sistem optic UGR<16.

Corp din profil de aluminiu extrudat, vopsit în câmp electrostatic.

Proiettori lineari orientabili per installazione su profili dei sistemi XTRIM S RECESSED e XTRIM S SURFACE, dotati di LED di potenza, lenti FRESNEL in PMMA e sistema di fissaggio magnetico.

Sistema ottico UGR<16.

Corpo in profilo estruso di alluminio verniciato in campo elettrostatico.

FINISHING AVAILABLE

BK

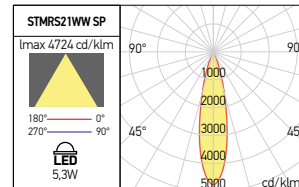
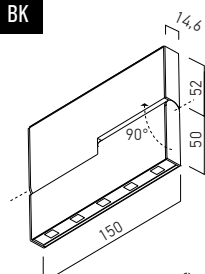

Code	Finishing	LED type	Power	Input voltage	LED Flux	System Flux	CCT	CRI	Optics	Weight
STMRs21WW SP	BK	POWER LED OSRAM	5,3W	48V DC	580 lm	424 lm	3000K	90	20°	0,50 kg

FINISHING AVAILABLE

BK

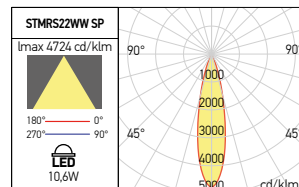
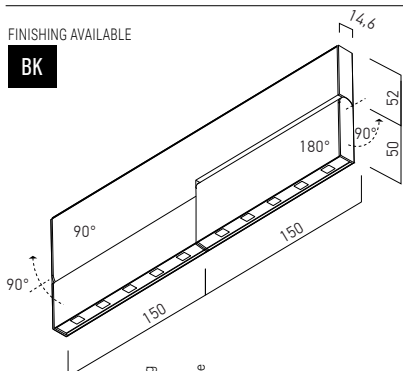

Code	Finishing	LED type	Power	Input voltage	LED Flux	System Flux	CCT	CRI	Optics	Weight
STMRs22WW SP	BK	POWER LED OSRAM	10,6W	48V DC	1160 lm	848 lm	3000K	90	20°	1,00 kg