



PORTABLE FITTINGS





LISENNE-0 Table lamp

EEC= A-A++ 230V~ IP44



+ Unobtrusive table lamp with smoked glass appearance



Socket/Lamp [excl.]:
E27 / TC(...).SE, 23W max.
up to max. Ø: 5,5 cm

Models:
■ stone grey

Item no.:
LI231360



Lamp options [excl.]:
LED

Material:
Basalt

Dimensions:
Product Ø/H: 12/28,5 cm
Glass Ø/H: 12/15,5 cm
Base Ø/H: 12/12,5 cm

Accessories/Included:
Mains plug: IP safety plug [incl.]
Switch [incl.]

LED UPGRADE:
Vinta SMD LED E27, 4W,
2200K, 350lm, EEC=A+
4kWh/1000h
LI551761



CUBIX 1

EEC= E-A++ 230V~ IP44

+ Portable



Socket/Lamp [excl.]:
GU10 / QPAR51, 25W max.

Models:
■ silver-grey

Item no.:
LI132832

Lamp options [excl.]:
LED

Material:
Aluminium/steel

Dimensions:
W/H/D: 10,5/14/11 cm
Connection lead L: 1,5 m

Accessories/Included:
Mains plug: IP safety plug [incl.]

Recommended lamp:
SMD LED 4,3W, 40°
2700K, 245lm, EEC=A+
5kWh/1000h
LI551252



CUBIX 2

EEC= E-A++ 230V~ IP44

+ Portable



Socket/Lamp [excl.]:
GU10 / QPAR51, 2x 25W max.

Models:
■ silver-grey

Item no.:
LI132842

Lamp options [excl.]:
LED

Material:
Aluminium/steel

Dimensions:
W/H/D: 18/14/11 cm
Connection lead L: 1,5 m

Accessories/Included:
Mains plug: IP safety plug [incl.]

Recommended lamp:
SMD LED 4,3W, 40°
2700K, 245lm, EEC=A+
5kWh/1000h
LI551252







ADEGAN MANILA TL



230V~



IP44



- + High-quality workmanship: foot made of granite, rod made of stainless steel
- + Weatherproof shade
- + Portable

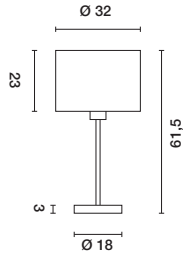

Socket/Lamp [excl.]:
E27 / TC(...)SE, 24W max.
up to max. Ø/H: 4,8/18 cm

Models:
■ ■ stainless steel/
anthracite

Item no.:
LI231385

Lamp options [excl.]:

Material:
Granite/stainless steel/polyethylene

Recommended lamp:
23W, 2700K, 1450lm, EEC=A
23kWh/1000h
LI508770



Dimensions:
Connection lead L: 2,5 m

Accessories/Included:
Mains plug: Euro IP [incl.]



ADEGAN MANILA SL



230V~



IP44



- + High-quality workmanship: foot made of granite, rod made of stainless steel
- + Weatherproof shade
- + Portable

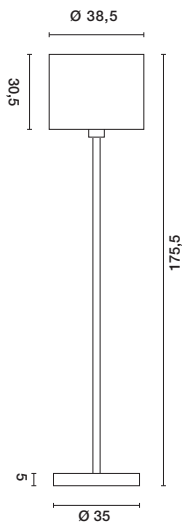

Socket/Lamp [excl.]:
E27 / TC(...)SE, 24W max.
up to max. Ø/H: 4,8/18 cm

Models:
■ ■ stainless steel/
anthracite

Item no.:
LI231395

Lamp options [excl.]:

Material:
Granite/stainless steel/polyethylene

Recommended lamp:
23W, 2700K, 1450lm, EEC=A
23kWh/1000h
LI508770



Dimensions:
Connection lead L: 2,5 m

Accessories/Included:
Mains plug: Euro IP [incl.]





ADEGAN

- + Portable
- + Shade: highly UV-proof polycarbonate



EEC= A-A++
230V~
↓
☂
IP54
□

Socket/Lamp [excl.]:
E27 / TC(...).SE, 24W max.
up to max. Ø: 5,2 cm

Models:
 anthracite/white **L1228965**
 white/white **L1228961**

Lamp options [excl.]:

Material:
Aluminium/polycarbonate

Recommended lamp:
23W, 2700K, 1450lm, EEC=A
23kWh/1000h
L1508770

Dimensions:
Connection lead L: 2,5 m

Accessories/Included:
Mains plug: Euro IP [incl.]
Earth spike [excl.]

Note:
The fitting is ideally suited for outdoors with its closed plastic shade.

The earth spike gets screwed into the base plate from below. The fitting can then be spiked into the earth.

Recommended accessory:
Earth spike, aluminium
Ø/L: 3/30 cm
 anthracite
L1228960

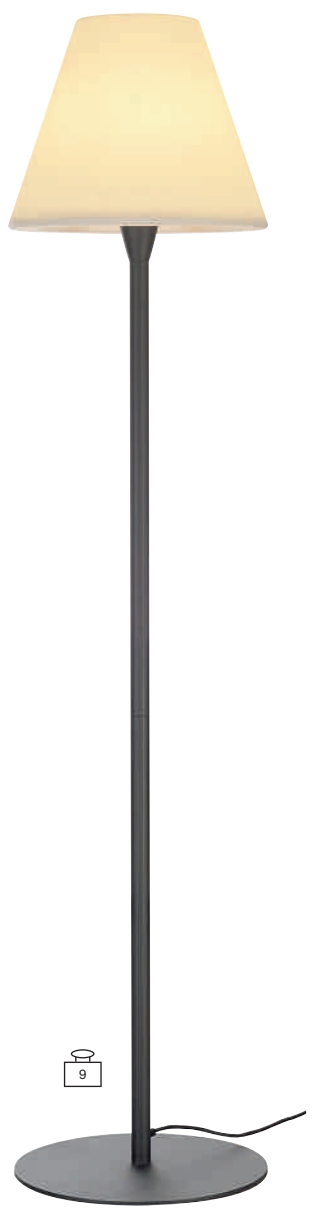
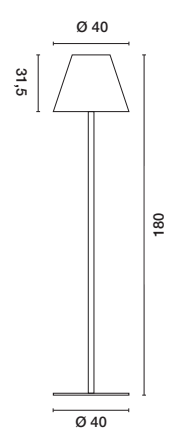

The IP rating of the Adegan fittings is achieved by a closed lamp shade made of high-tensile polycarbonate. In order to avoid heat accumulation within the shade, no standard lamps must be used. The fittings are intended for operation with energy-saving or LED lamps only.





PLENUM® SWING

Portable



230V~



IP44



Socket/Lamp [excl.]:
E27 / TC(..)SE, 25W max.
up to max. Ø/L: 5,2/17,3 cm

Models:
 anthracite/white **Item no.:**
LI228995

Lamp options [excl.]:

Recommended lamp:
23W, 2700K, 1450lm, EEC=A
23kWh/1000h
LI508770



Material:
Aluminium/polycarbonate

Dimensions:
Connection lead L: 3 m

Accessories/Included:
Mains plug: Euro IP [incl.]

Note:
The fitting is ideally suited for outdoors with its closed plastic shade.

PLENUM® MOVE

Portable



230V~



IP44

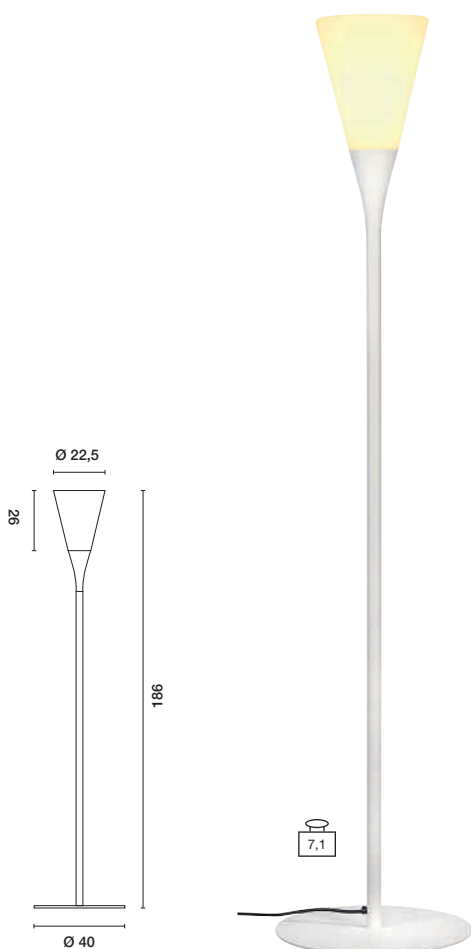

Socket/Lamp [excl.]:
E27 / TC(..)SE, 25W max.
up to max. Ø/L: 5,2/17,3 cm

Models:
 white/white **Item no.:**
LI228971
 anthracite/white **LI228975**

Lamp options [excl.]:

Recommended lamp:
23W, 2700K, 1450lm, EEC=A
23kWh/1000h
LI508770



Material:
Aluminium/polycarbonate

Dimensions:
Base Ø/H: 40/0,5 cm
Connection lead L: 2,5 m

Accessories/Included:
Mains plug: Euro IP [incl.]

Note:
The fitting is ideally suited for outdoors with its closed plastic shade.

The earth spike gets screwed into the base plate from below. The fitting can then be spiked into the earth.

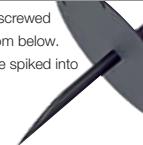

Recommended accessory:
Earth spike, aluminium
Ø/L: 3/30 cm
 anthracite
LI228960





ROTOBALL SWING

Outdoor pendants

Set special accents with the **Rotoball Swing** Outdoor pendants!

Whether in small front gardens or vast garden areas, whether with 25 cm, 40 cm oder 50 cm diameters – the shapely, functional fittings can be used quite variably.

Especially in group formation or in combination with the portable floor lamp Rotoball Floor the pendant Rotoball Swing creates a unique, atmospheric ambiance.





+ ROTOBALL SWING 25 / 40 / 50



230V~



IP44



144

- + Portable
- + Can be adjusted individually



550+



Socket/Lamp [excl.]:
E27 / TC(...)SE, 24W max.

Lamp options [excl.]:
LED

Material:
Aluminium/polyethylene/stainless steel

Accessories/Included:
Mains plug; Euro IP [incl.]
Chain [incl.]
Snap hook [incl.]

Models:
 white/silver-grey
Rotoball Swing 25 **LI228050**

Rotoball Swing 40 **LI228051**

Rotoball Swing 50 **LI228052**

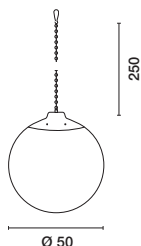
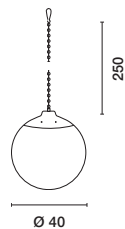
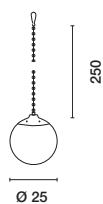

LED UPGRADE:
PHILIPS SMD LED 13W,
dimmable
2700K, 1055lm, EEC=A+
13kWh/1000h
LI560150



LED UPGRADE:
PHILIPS SMD LED 18W,
dimmable
2700K, 1521lm, EEC=A+
18kWh/1000h
LI560151





ROTOBALL FLOOR 50

ROTOBALL FLOOR 40

ROTOBALL FLOOR 25

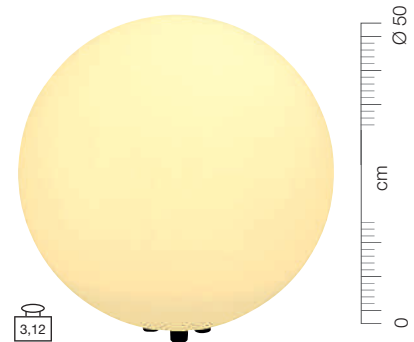
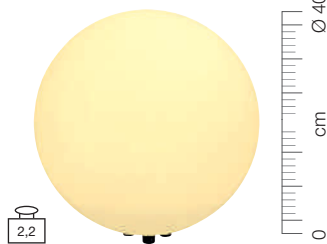

ROTOBALL FLOOR 25 / 40 / 50

EEC= A-A++ 230V~ IP44



+ Special spherical design – makes any outdoor area an eye-catcher



Socket/Lamp [excl.]:
E27 / TC(...)
SE, 24W max.
up to max. Ø: 9,5 cm

Lamp options [excl.]:
LED

Material:
Polyethylene/steel

Dimensions:
Connection lead L: 2 m

Accessories/Included:
Mains plug: IP safety plug [incl.]

Models:

white
Rotoball Floor 25

Rotoball Floor 40

Rotoball Floor 50

Item no.:

LI227219

LI227220

LI227221

LED UPGRADE:

PHILIPS Corepro LED E27, 9,5W,
dimmable
2700K, 806lm, EEC=A+
10kWh/1000h
LI560161

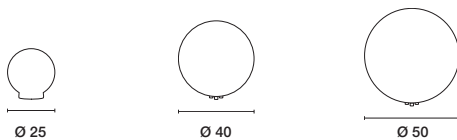

The outdoor fittings Rotoball Floor 25/40/50 are translucent light objects which are eye-catchers in any garden area thanks to their classic shape. We would like to point out that, despite their high-tensile material, the fittings are not suitable to be sat on. In order to avoid heat accumulation, no standard lamps must be used.



LIPSY® OUT FLOOR

↳ Portable, translucent light object in elliptical shape



Socket/Lamp [excl.]:
E27 / TC(...).SE, 23W max.
up to max. L: 11,6 cm

EEC= A~A+ 230V~ IP44

Models:
 white

Item no.:
LI227361

Lamp options [excl.]:
LED

Material:
Polyethylene/steel

Dimensions:
Ø/H: 34/22 cm
Connection lead L: 2 m

Accessories/Included:
Mains plug: Euro IP [incl.]

LED UPGRADE:
PHILIPS Corepro LED E27, 9,5W,
dimmable
2700K, 806lm, EEC=A+
10kWh/1000h
LI560161



DETT

↳ Portable, translucent light object in dice shape



Socket/Lamp [excl.]:
E27 / TC(...).SE, 24W max.
up to max. Ø: 6 cm

EEC= A~A+ 230V~ IP54

Models:
 white

Item no.:
LI227211

Lamp options [excl.]:
LED

Material:
Polyethylene/steel

Dimensions:
L/W/H: 30/30/32 cm
Connection lead L: 2 m

Accessories/Included:
Mains plug: Euro IP [incl.]

LED UPGRADE:
PHILIPS Corepro LED E27, 5,5W,
2700K, 470lm, EEC=A+
6kWh/1000h
LI560160

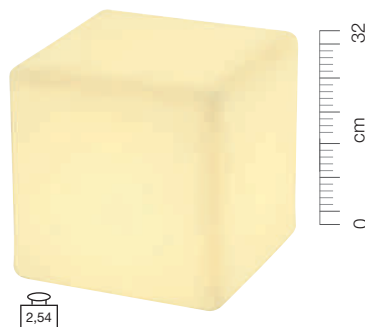

The outdoor fittings Lipsy® Out Floor and Dett are translucent light objects which are eye-catchers in any garden area thanks to their classic shape. We would like to point out that, despite their high-tensile material, the fittings are not suitable to be sat on. In order to avoid heat accumulation, no standard lamps must be used.



PATH LIGHTS

 555	 559	 569	 559	 571	 573	 571	 573
 575	 575	 559	 559	 557	 557	 561	 595
 563	 563	 563					
 603	 603	 601					



SMALL FLOOR STANDS [15–35 cm]



MEDIUM FLOOR STANDS [40–70 cm]



TALL FLOOR STANDS [75–200 cm]







KYKLOP POLE

EEC=A++ 200V~240V~350mA LED 3 pcs. 30000 ↓ 7-12 IP44



- + LED
- + Flat rear side enables positioning with rear to wall

Lamp [incl.]:
 LED PowerLED, 3x 1W
 Total consumption: 5,3W

Models: **Item no.:**
 Glass frosted
 3000K, 130lm, CRI 80
 ■ anthracite **LI231495**

Material:
 Aluminium/glass

Dimensions:
 W/H/D: 13,5/18/10,6 cm

Accessories/Included:
 LED driver [incl.]



1,05

CONE

EEC=E-A++ 230V~ ↓ IP54

Socket/Lamp [excl.]:
 E27 / A60, 100W max.
 up to max. length: 15 cm

Models: **Item no.:**
 ■ silver-grey **LI230434**
 ■ anthracite **LI230435**

Lamp options [excl.]:
 QA60 / TC(...)/SE / LED

Material:
 Aluminium/glass

Dimensions:
 Ø/H: 19/24 cm

LED UPGRADE: 
PHILIPS Corepro LED E27, 9,5W,
 dimmable 
 2700K, 806lm, EEC=A+
 10kWh/1000h
LI560161



2,55





DELWA PATHLIGHT

+ Premium LED



230V~



LED
4 pcs.



IP44



Lamp [incl.]:
 PowerLED, 4x 1,5W
 Total consumption: 6,8W

Material:
 Aluminium

Models:
 3000K, 100lm, CRI 80
 white
 anthracite
 alu brushed

Item no.:
 LI232201
 LI232205
 LI232206

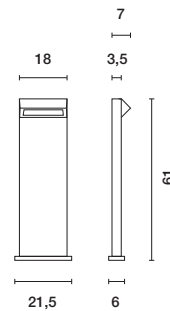

INSIDE

Recommended accessory:
 Connection box IP68, plastic, 3-pole,
 L/W/H: 11/6,4/3 cm. For a safe
 connection in the body.
LI228726



Recommended accessory:
 Earth spike, stainless steel 304
 Spike L: 50 cm
LI229841



Recommended accessory:
 Concrete anchor set
 stainless steel 304
LI229840



IPERI 50



230V~



LED
48 pcs.



9-12



IP44



Lamp [incl.]:
 SMD LED, 4W
 Total consumption: 5W

Material:
 Aluminium/plastic

Models:
 4000K, 320lm, CRI>70
 white
 anthracite

Item no.:
 LI231301
 LI231305

Accessories/Included:
 Connection box [incl.]

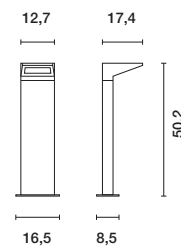

INSIDE

Recommended accessory:
 Earth spike, steel galvanised
 Spike L: 50 cm
LI231231







SLOTBOX 40 / 70

Special light effect

EEC= A-A++ 230V~ 350 mA (LED) LED 1 pce. IP44



Lamp [incl.]:
 PowerLED
 4,3W, 320lm
 Total consumption: 5,9W

Material:
 Aluminium

Accessories/Included:
 LED driver [incl.]

Note:
 Connection lead: open cable end.

Models:
 3000K, CRI 80
 ■ anthracite
 40 cm **LI232135**
 70 cm **LI232145**



Recommended accessory:
 Connection box IP68, plastic, 3-pole,
 Ø/L: 2,7/11,5 cm. For a safe
 connection in the body.
LI228730

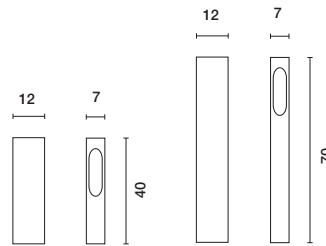

LOGS 40 / 70

Indirect illumination
 Premium LED



EEC= A-A++ 100V~240V~ 480mA (LED) LED 1 pce. 4000K IP44



Lamp [incl.]:
 COB LED, 6W
 Total consumption: 8W

Material:
 Aluminium

Accessories/Included:
 LED driver [incl.]
 Screws and plugs [excl.]

Models:
 LOGS 40
 3000K, 330lm, CRI>80
 ■ silver-grey **LI232114**
 ■ anthracite **LI232115**

LOGS 70
 3000K, 330lm, CRI>80
 ■ silver-grey **LI232124**
 ■ anthracite **LI232125**



Recommended accessory:
 Connection box IP68, plastic, 3-pole,
 Ø/L: 2,7/11,5 cm. For a safe
 connection in the body.
LI228730



Recommended accessory:
 Earth spike, steel galvanised
 Product L: 48 cm
LI231230



Recommended accessory:
 Set of screws, stainless steel
 Ø/L: 0,55/3,8 cm
LI228754

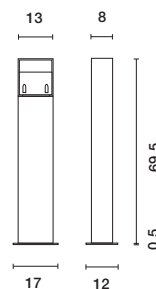
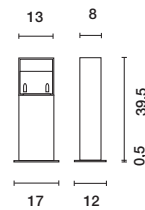





BOOKAT Floor stand

- + Unusual, massive design by Markus Becker
- + Special light effect
- + Flicker <20%
- + No LED driver, HV LED



2,5



230V~



LED
1 Module



IP44



Lamp [incl.]:
LED COB LED, 12,5W

Material:
Aluminium

Dimensions:
W/H/D: 30/100/6 cm

Note:
Connection lead: open cable end.

Models:
3000K, 520lm, CRI 80
■ anthracite

Item no.:
LI231855

Coming soon: January 2016



Recommended accessory:
Connection box IP68, plastic, 3-pole, Ø/L: 2,7/11,5 cm. For a safe connection in the body.
LI228730



BACCO 70 / 90



3,2

3,5



230V~



IP44



Socket/Lamp [excl.]:
E27 / TC(...SE), 15W max.
up to max. Ø/L: 4,8/17 cm

Lamp options [excl.]:
LED

Material:
Aluminium/polycarbonate

Accessories/Included:
Connection box [incl.]

Models:
■ anthracite
Bacco 70

Item no.:
LI231325

Bacco 90
LI231335

Recommended lamp:
15W, 2700K, 800lm, EEC=A
15kWh/1000h
LI508415



Recommended accessory:
Earth spike, steel galvanised
Spike L: 50 cm
LI231232

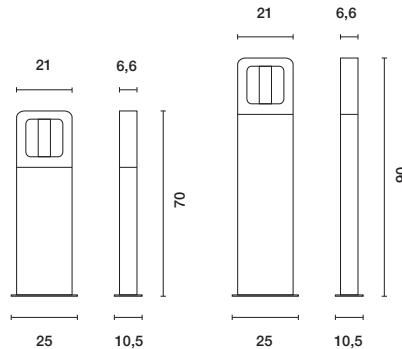

TRAPECCO

- + Trapezoid design



673



3,8



230V~



Module
24 LEDs



IP44



Lamp [incl.]:
LED SMD LED
Total consumption: 10W

Material:
Aluminium

Accessories/Included:
LED driver [incl.]
Concrete anchor set [incl.]

Note:
Connection lead: open cable end.

Models:
3000K, 850lm, CRI>80
■ anthracite

Item no.:
LI231765

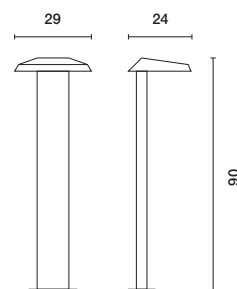



[LI229756] | page 702

[LI233530] | page 720



ENOLA_C OUT POLE

EEC=A-A++ 100V-240V- 500mA LED 1 Module 30000 35° 45° IP55

- 647
- 689
- 703

Adjustable lamp head
Premium LED



Lamp [incl.]:
COB LED, 9W
Total consumption: 12W

Material:
Aluminium/glass

Dimensions:
L/W/H: 11,9/18,7/51 cm
Head Ø/L: 10/11,7 cm
Base plate L/W/H: 15,9/9,8/1 cm

Accessories/Included:
LED driver [incl.]

Models:
3000K, 700lm, CRI 80
■ anthracite

Item no.:
LI228545



Recommended accessory:
Connection box IP68, plastic, 3-pole, Ø/L: 2,7/11,5 cm. For a safe connection in the body.
LI228730



ROX PATHLIGHT

EEC=E-A++ 230V- 90° +/- IP44

- 255
- 639
- 702

Adjustable lamp head

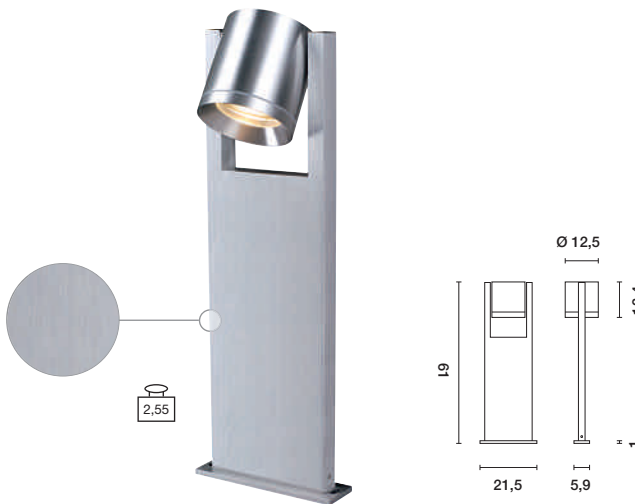

Socket/Lamp [excl.]:
GU10 / QPAR111, 50W max.

Lamp options [excl.]:
LED

Material:
Aluminium/glass

Note:
Not suitable for DomeLED [LI550382/92]

Recommended accessory:
Connection box IP68, plastic, 3-pole, L/W/H: 11/6,4/3 cm. For a safe connection in the body.
LI228726

Models:
■ alu brushed

Item no.:
LI229836

LED UPGRADE:
LED ES111, 17,5W, 30°
dimmable
2700K, 880lm, EEC=A
18kWh/1000h
LI551642

Recommended accessory:
Concrete anchor set stainless steel 304
LI229840

Recommended accessory:
Earth spike, stainless steel 304
Spike L: 50 cm
LI229841



ROX PATHLIGHT GX53

EEC=B-A++ 230V- 90° +/- IP44

- 255
- 639
- 702

Adjustable lamp head



Socket/Lamp [excl.]:
GX53 / TCR-TSE 9W max.
up to max. Ø/H: 7,5/3,5 cm

Lamp options [excl.]:
LED

Material:
Aluminium/glass

Recommended accessory:
Connection box IP68, plastic, 3-pole, L/W/H: 11/6,4/3 cm. For a safe connection in the body.
LI228726

Models:
■ alu brushed

Item no.:
LI229856

LED UPGRADE:
LED GX53 4,2W, 35°
3000K, 200lm, EEC=A
5kWh/1000h
LI550092

Recommended accessory:
Concrete anchor set stainless steel 304
LI229840

Recommended accessory:
Earth spike, stainless steel 304
Spike L: 50 cm
LI229841





RUSTY – FITTINGS MADE OF RUSTED STEEL

The fittings of our RUSTY range impress with their unusual rusty appearance and make any outdoor area quite special.

The warm rusty appearance is achieved by a special chemical treatment of the FeCSi steel used.

This makes every fitting exclusively unique and a very special feature for every application.

Pollards and path lights, round or square, in different heights and with different light effect – the extensive RUSTY range leaves nothing to be desired.



FeCSi STEEL
[L1229430]





RUSTY 40 / 70 square

- + Steel rusted
- + Each fitting is unique



230V~



IP55



Socket/Lamp [excl.]:
E27 / TC(...).SE, 11W max.
up to max. Ø/L: 4,8/13,9 cm

Models:	Item no.:
■ steel rusted Rusty 40, square	LI229420
Rusty 70, square	LI229421

Lamp options [excl.]:

Material:
FeCSi-steel/polycarbonate

LED UPGRADE:

LED E27 Tube, 4,7W,
3000K, 380lm, EEC=A+
5kWh/10000h
LI551532



Recommended accessory:
Earth spike, steel galvanised
Product L: 50 cm
LI229422

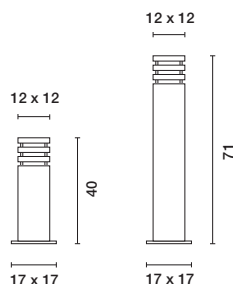
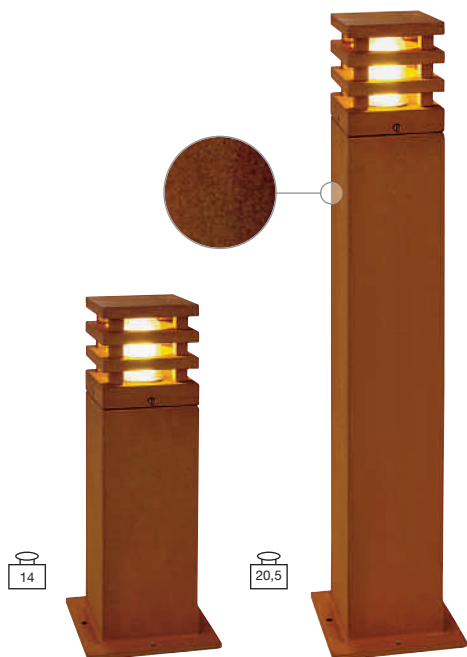

RUSTY 40 / 70 LED square

- + Steel rusted
- + Each fitting is unique
- + Flicker <20%



220V~
-240V~



1 Module



IP55



Lamp [incl.]:
 SMD LED, 8,6W
Total consumption: 8,6W

Models:	Item no.:
■ steel rusted 3000K, 430lm, CRI 80 Rusty 40 LED	LI233427
Rusty 70 LED	LI233437

Material:
FeCSi steel/polycarbonate

INSIDE



Recommended accessory:
Earth spike, steel galvanised
Product L: 50 cm
LI229422

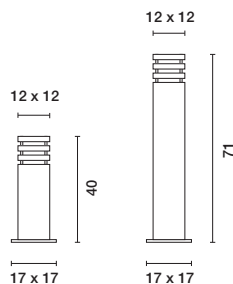
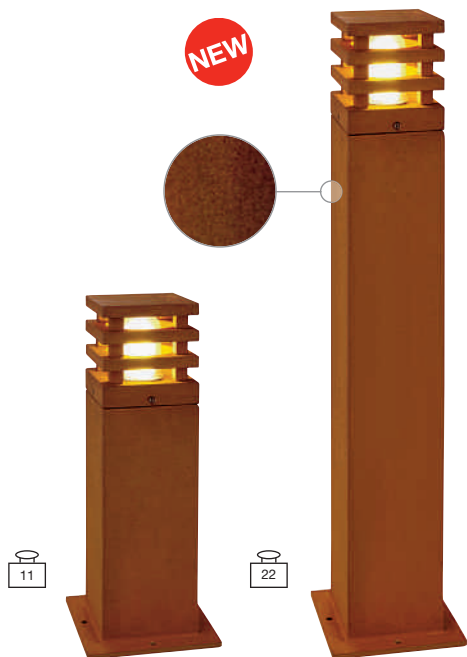





RUSTY 40 / 70 LED round

- + Steel rusted
- + Each fitting is unique

EEC= A-A+ 230V- IP55

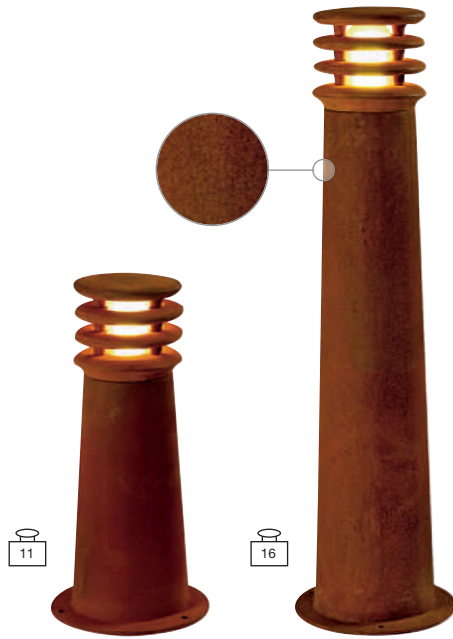

Socket/Lamp [excl.]:
E27 / TC(...)SE, 11W max.
up to max. Ø/L: 4,8/13,9 cm

Models:	Item no.:
steel rusted Rusty 40	LI229020
Rusty 70	LI229021

Lamp options [excl.]:
LED

Material:
FeCSi steel/polycarbonate

LED UPGRADE:
LED E27 Tube, 4,7W,
3000K, 380lm, EEC=A+
5kWh/10000h
LI551532



Recommended accessory:
Connection box IP68, plastic, 3-pole,
Ø/L: 2,7/11,5 cm. For a safe
connection in the body.
LI228730



Recommended accessory:
Earth spike, steel galvanised
Product L: 50 cm
LI229022

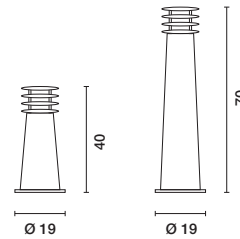

RUSTY 40 / 70 LED round

- + Steel rusted
- + Each fitting is unique
- + Flicker <20%

EEC= A-A++ 220V-240V- LED 1 Module 35000 IP55

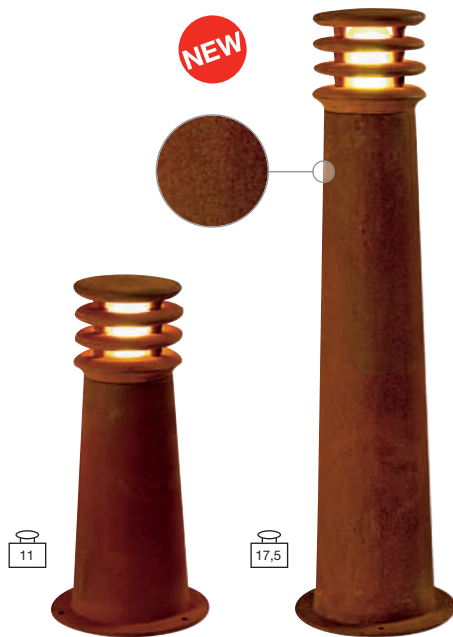

Lamp [incl.]:
COB LED, 8,6W
Total consumption: 8,6W

Models:	Item no.:
steel rusted 3000K, 430lm, CRI 80 Rusty 40 LED	LI233407
Rusty 70 LED	LI233417

Material:
FeCSi steel/polycarbonate



Recommended accessory:
Connection box IP68, plastic, 3-pole,
Ø/L: 2,7/11,5 cm. For a safe
connection in the body.
LI228730



Recommended accessory:
Earth spike, steel galvanised
Product L: 50 cm
LI229022

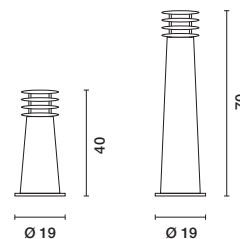





RUSTY CONE

Steel rusted – a special patina for any weather

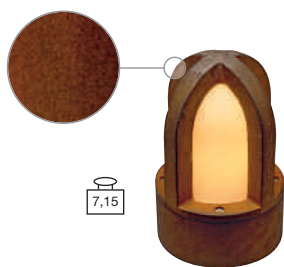

7,15

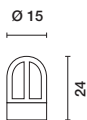

230V~



IP54



Socket/Lamp [excl.]:
E14 / C35, 40W max.
up to max. Ø/L: 4,8/13,5 cm

Models:
Glass frosted
■ steel rusted

Item no.:
LI229430

Lamp options [excl.]:
QC35 / TC(...)/SE / LED

Material:
FeCSi steel/glass

LED UPGRADE:
PHILIPS Corepro LED E14, 3W
2700K, 250lm, EEC=A+
3kWh/1000h
LI560222



Note:
Each fitting is unique.

RUSTY CONE 40 / 70

Steel rusted – a special patina for any weather

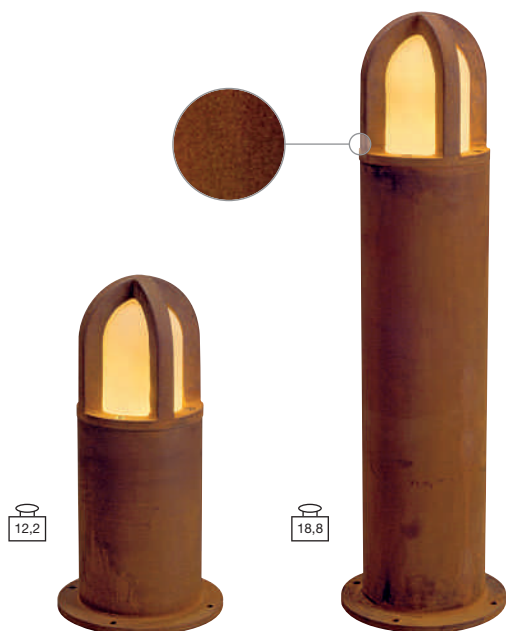

12,2

18,8

Socket/Lamp [excl.]:
E27 / TC(...)/SE, 11W max.
up to max. Ø/L: 4,8/13,9 cm

Models:
Glass frosted
■ steel rusted
Rusty Cone 40

Item no.:
LI229431

Lamp options [excl.]:
LED

Rusty Cone 70 **LI229432**

Material:
FeCSi steel/glass

LED UPGRADE:
LED E27 Tube, 4,7W,
3000K, 380lm, EEC=A+
5kWh/1000h
LI551532



Note:
Each fitting is unique.

Recommended accessory:
Connection box IP68, plastic, 3-pole,
Ø/L: 2,7/11,5 cm. For a safe
connection in the body.
LI228730

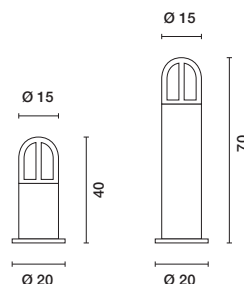

Recommended accessory:
Earth spike, steel galvanised
Product L: 50 cm
LI229423



RUSTY PATHLIGHT

Steel rusted – a special patina for any weather

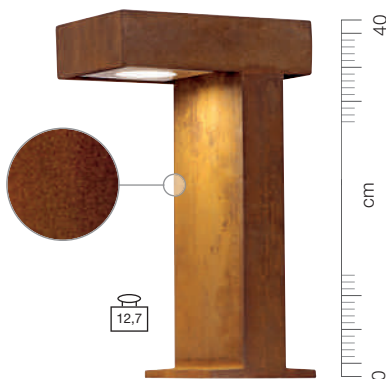

12,7



230V~



IP44



Socket/Lamp [excl.]:
GX53 / TCR-TSE 9W max.
up to max. Ø/H: 7,5/2,7 cm

Models:
■ steel rusted

Item no.:
LI230090

Lamp options [excl.]:
LED

Material:
FeCSi steel
Inner housing: aluminium

LED UPGRADE:
LED GX53, 3W, 120°
3000K, 250lm, EEC=A+++
3kWh/1000h
LI551372



Note:
Each fitting is unique.

Recommended accessory:
Connection box IP68, plastic, 3-pole,
Ø/L: 2,7/11,5 cm. For a safe
connection in the body.
LI228730

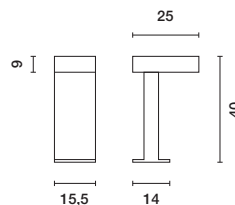

Recommended accessory:
Earth spike, steel galvanised
Product L: 50 cm
LI229422







RUSTY 50 / 80 Slot

EEC= A-A+ 230V~ IP44

- + Steel rusted
- + Each fitting is unique

Socket/Lamp [excl.]:
E27 / TC(...)SE, 11W max.
up to max. Ø/L: 4,8/13,9 cm

Models:	Item no.:
steel rusted Rusty Slot 50	LI229410
Rusty Slot 80	LI229411

Lamp options [excl.]:
LED

Material:
FeCSi steel

LED UPGRADE:
LED E27 Tube, 4,7W,
3000K, 380lm, EEC=A+
5kWh/10000h
LI551532



Recommended accessory:
Connection box IP68, plastic, 3-pole,
Ø/L: 2,7/11,5 cm. For a safe
connection in the body.
LI228730



Recommended accessory:
Earth spike, steel galvanised
Product L: 48 cm
LI231230

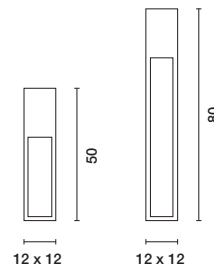
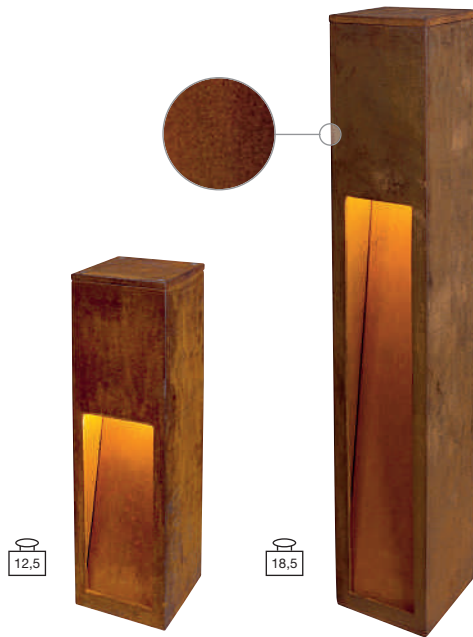

RUSTY 50 / 80 LED Slot

EEC= A-A++ 220V~ -240V~ LED 1 Module 85000 IP55

- + Steel rusted
- + Each fitting is unique
- + Flicker <20%

Lamp [incl.]:
SMD LED, 8,6W
Total consumption: 8,6W

Models:	Item no.:
steel rusted 3000K, 430lm, CRI 80 Rusty 50 LED	LI233447
Rusty 80 LED	LI233457

Material:
FeCSi steel/polycarbonate

INSIDE

Recommended accessory:
Connection box IP68, plastic, 3-pole,
Ø/L: 2,7/11,5 cm. For a safe
connection in the body.
LI228730



Recommended accessory:
Earth spike, steel galvanised
Product L: 48 cm
LI231230

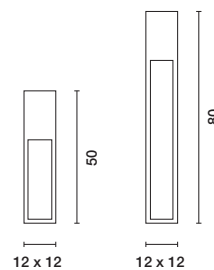
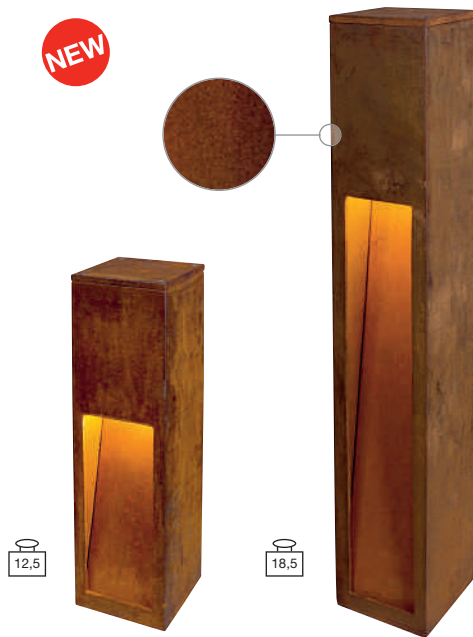



NATURAL STONE FITTINGS

In unison with nature.

Outdoor fittings made of natural stone grant any outdoor area a very exclusive appearance. Fittings made of natural stone are not only robust but because of their different surface qualities always individually unique. They naturally melt into their surroundings – park or garden, path, entrance area or terrace.

Sand stone fittings impress with their individual structure and different colour shades. Basalt fittings, originated from volcanic material, distinguish themselves with their robust, lasting quality and grained surface. Granite fittings, in their composition rich with quartz crystal and feldspar, due to the materials contained attract attention with their glimmer appearance.

In any fitting made of natural stone, refined patina, sculpture and light meld into a coherent eye-catcher.



SANDSTONE
[LI231400]



BASALT
[LI231370]



GRANITE
[LI231420]



ARROCK SAND 40 / 70

↳ Natural stone sandstone, stainless steel



230V~



IP44

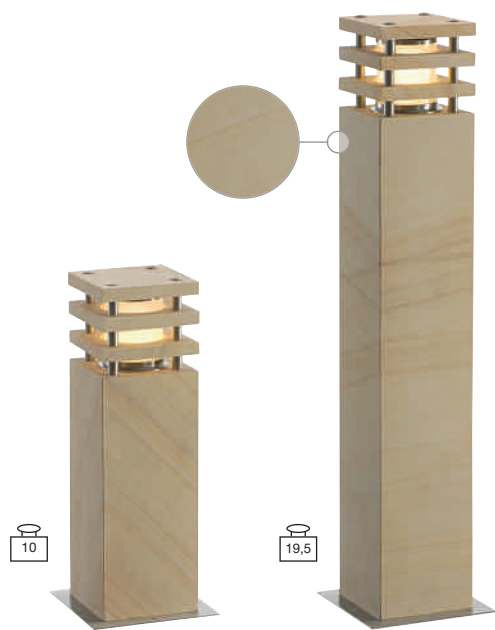

Socket/Lamp [excl.]:
E27 / TC(...)SE, 15W max.
up to max. Ø/L: 5,2/11,5 cm

Lamp options [excl.]:

Material:
Sandstone/stainless steel 304

Note:
Sandstone is a natural product.
Each fitting is unique.

Models:	Item no.:
■ sandstone Arrock Sand 40	LI231400
Arrock Sand 70	LI231401

Recommended lamp:
15W, 2700K, 970lm, EEC=A
15kWh/1000h
LI509012



Recommended accessory:
Earth spike, steel galvanised
Spike L: 50 cm
LI231232

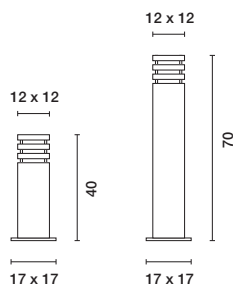

ARROCK STONE 50 / 75

↳ Natural stone
↳ Premium LED



100V-
-240V-
700mA



LED
1 Module



IP44



Lamp [incl.]:
 COB LED, 6W
Total consumption: 9W

Material:
Basalt

Accessories/Included:
LED driver [incl.]

Models:	Item no.:
■ stone grey 3000K, 350lm, CRI 80 LED Stone 50	LI231370
LED Stone 75	LI231371

INSIDE

Recommended accessory:
Earth spike, steel galvanised
Product L/W/D: 17/17/48,5 cm
Weight: 1,27 kg
LI231235

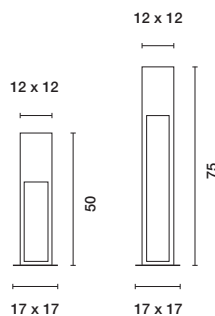





ARROCK SLOT GU10

+ Natural stone granite, stainless steel



230V~



IP44

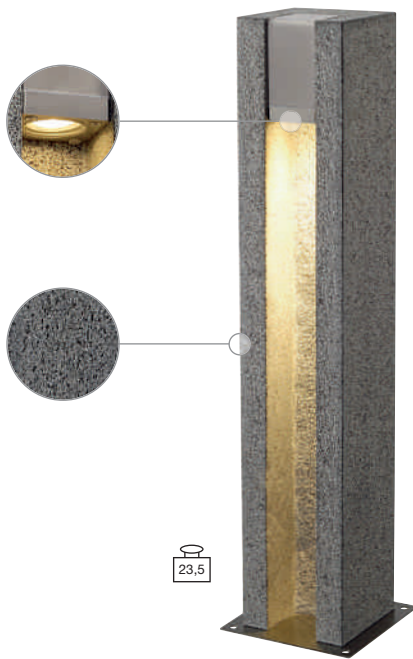

Socket/Lamp [excl.]:
GU10 / GU10 51 mm, 4W max.

Models:
■ salt & pepper

Item no.:
LI231440

Material:
Granite/stainless steel 304

Note:
Connection lead: open cable end.
Granite is a natural product.
Each fitting is unique.

LED UPGRADE:
PHILIPS Corepro LED Spot 3,5W, 36°
3000K, 245lm, EEC=A+
4kWh/1000h
LI560084



Recommended accessory:
Earth spike, steel galvanised
Product L/W/D: 17/17/48,5 cm
Weight: 1,27 kg
LI231235



Recommended accessory:
Connection box IP68, plastic, 3-pole,
Ø/L: 2,7/11,5 cm. For a safe
connection in the body.
LI228730

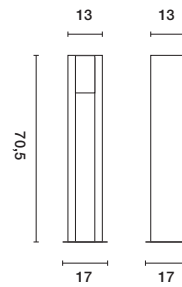

ARROCK ARC GU10

+ Natural stone granite, stainless steel



230V~



IP44

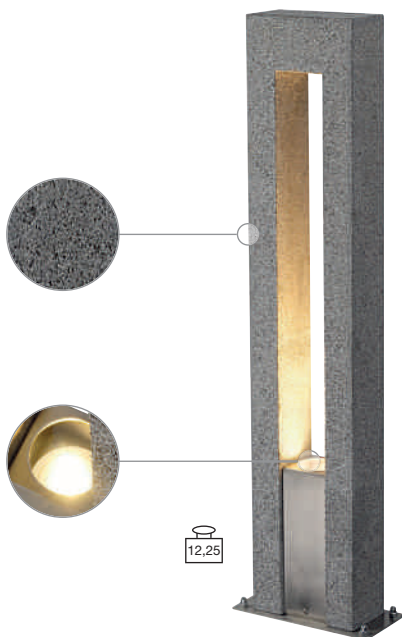

Socket/Lamp [excl.]:
GU10 / QPAR51, 35W max.
up to max. Ø/L: 5/7,6 cm

Models:
■ salt & pepper

Item no.:
LI231420

Lamp options [excl.]:

Material:
Granite/stainless steel 304

Note:
Granite is a natural product.
Each fitting is unique.

LED UPGRADE:
PHILIPS Corepro LED Spot 3,5W, 36°
3000K, 245lm, EEC=A+
4kWh/1000h
LI560084



Recommended accessory:
Earth spike, steel galvanised
Product L: 50 cm
LI231233

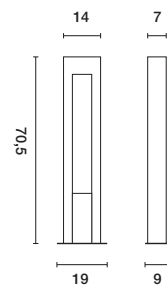





ARROCK GRANITE 40 / 70

+ Natural stone granite, stainless steel



230V~



IP44

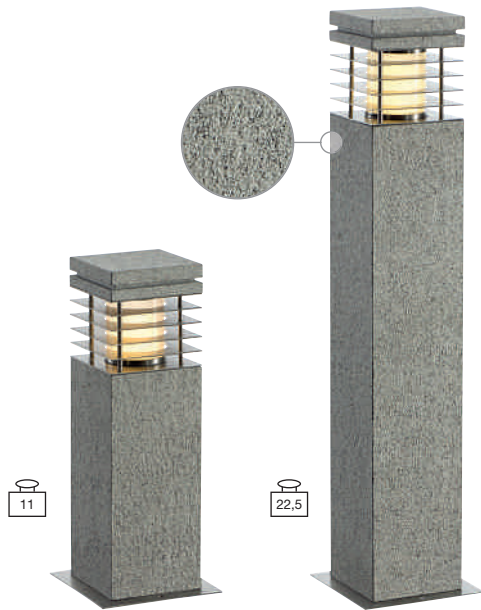

Socket/Lamp [excl.]:
E27 / TC(...)SE, 15W max.
up to max. Ø/L: 5,2/11,5 cm

Lamp options [excl.]:

Material:
Granite/stainless steel 304

Note:
Granite is a natural product.
Each fitting is unique.

Models:
■ salt & pepper
Arrock Granite 40 **LI231410**
Arrock Granite 70 **LI231411**

Recommended lamp:
15W, 2700K, 970lm, EEC=A
15kWh/1000h
LI509012



Recommended accessory:
Earth spike, steel galvanised
Product L: 50 cm
LI229422



Recommended accessory:
Connection box IP68, plastic, 3-pole,
Ø/L: 2,7/11,5 cm. For a safe
connection in the body.
LI228730

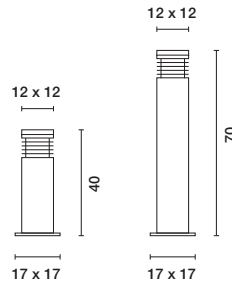

ARROCK GRANITE 40 / 70 ROUND

+ Natural stone granite, stainless steel



230V~



IP44

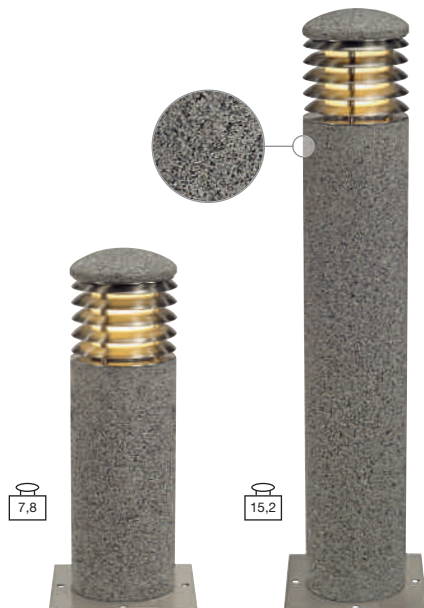

Socket/Lamp [excl.]:
E27 / TC(...)SE, 15W max.
up to max. Ø/L: 4,4/11,5 cm

Lamp options [excl.]:

Material:
Granit/stainless steel 304

Note:
Granite is a natural product.
Each fitting is unique.

Models:
■ salt & pepper
Arrock Granite 40 Round **LI231430**
Arrock Granite 70 Round **LI231431**

Recommended lamp:
11W, 2700K, 600lm, EEC=A
11kWh/1000h
LI508211



Recommended accessory:
Earth spike, steel galvanised
Product L: 50 cm
LI229422



Recommended accessory:
Connection box IP68, plastic, 3-pole,
Ø/L: 2,7/11,5 cm. For a safe
connection in the body.
LI228730

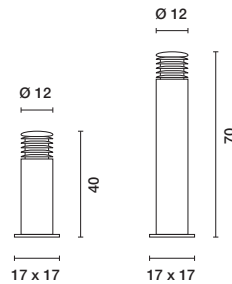





POLE PARC

The 1,5 m and 2 m light columns were designed for extensive gardens and parks. The diagonally downwards-directed fins of the grid built into the lamp head ensure efficient illumination of the surroundings while the timeless modern design of the fittings unobtrusively melts into your garden design.



POLE PARC 150

- + Quickstart electronic ballast
- + High-gloss reflector – for effective illumination
- + High-output lamp – for professional application



EEC=A
230V~
↓
IP44
⊕

Socket/Lamp [excl.]:
2G11 / TC-L, 36W

Material:
Aluminium/polycarbonate

Accessories/Included:
Electronic ballast [incl.]
Concrete anchor set [incl.]

Models:
■ anthracite

Item no.:
LI227985

Recommended lamp:
36W, 4000K, 2900lm, EEC=A
40kWh/1000h
LI590145

Recommended accessory:
Connection box IP68, plastic, 3-pole,
Ø/L: 2,7/11,5 cm. For a safe
connection in the body.
LI228730

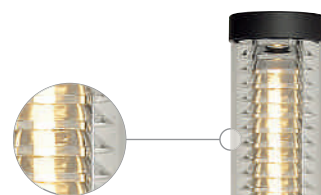

POLE PARC 200

- + Quickstart electronic ballast
- + High-gloss reflector – for effective illumination
- + High-output lamp – for professional application

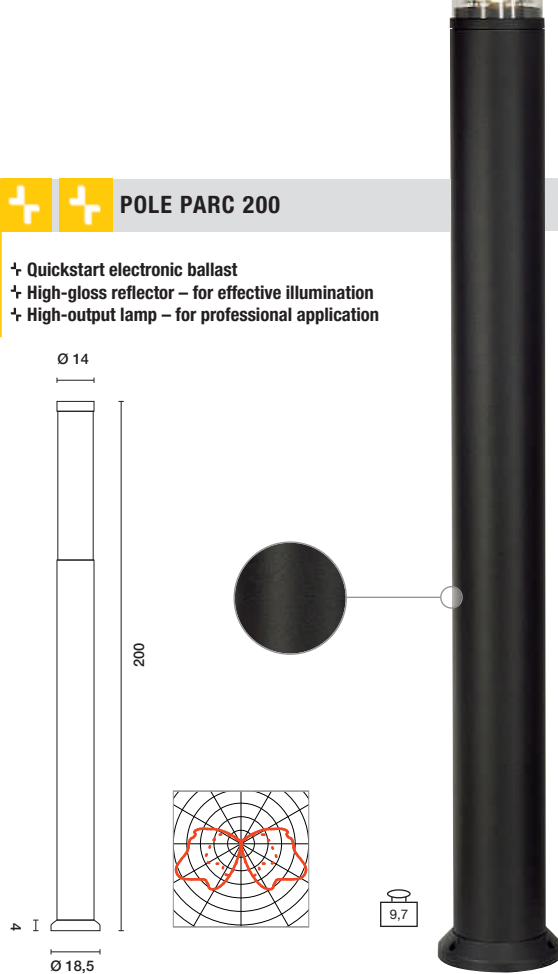

EEC=A
230V~
↓
IP44
⊕

Socket/Lamp [excl.]:
2G11 / TC-L, 55W

Material:
Aluminium/polycarbonate

Accessories/Included:
Electronic ballast [incl.]
Concrete anchor set [incl.]

Models:
■ anthracite

Item no.:
LI227975

Recommended lamp:
55W, 3000K, 4800lm, EEC=A
61kWh/1000h
LI508450

Recommended accessory:
Connection box IP68, plastic, 3-pole,
Ø/L: 2,7/11,5 cm. For a safe
connection in the body.
LI228730







F-POL



230V~



IP54



High-gloss reflector – for effective illumination

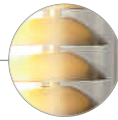

Socket/Lamp [excl.]:
E27 / TC(...).SE, 20W max.
up to max. Ø/L: 5/14,8 cm

Lamp options [excl.]:

Material:
Aluminium/polycarbonate

Models:
■ anthracite

Item no.:
LI231595

Recommended lamp:
20W, 2700K, 1200lm, EEC=A
20kWh/1000h
LI508760



Recommended accessory:
Connection box IP68, plastic, 3-pole,
Ø/L: 2,7/11,5 cm. For a safe
connection in the body.
LI228730



2.85

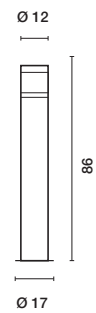

C-POL



230V~



IP54



High-gloss reflector – for effective illumination



Socket/Lamp [excl.]:
E27 / TC(...).SE, 24W max.
up to max. Ø/L: 5,2/17,3 cm

Lamp options [excl.]:

Material:
Aluminium/polycarbonate

Models:
■ anthracite

Item no.:
LI231475

Recommended lamp:
23W, 2700K, 1450lm, EEC=A
23kWh/1000h
LI508770



Recommended accessory:
Connection box IP68, plastic, 3-pole,
Ø/L: 2,7/11,5 cm. For a safe
connection in the body.
LI228730



2.9

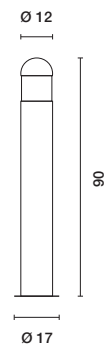





OTOS GLASS



230V~



IP43



2,6



Socket/Lamp [excl.]:
E27 / TC(...).SE, 15W max.
up to max. Ø/L: 6,5/14,5 cm

Models:
■ silver-grey
■ anthracite

Item no.:
LI230464
LI230465

Lamp options [excl.]:

Material:
Aluminium/glass

Dimensions:
Ø/H: 15,5/93,5 cm

Accessories/Included:
Concrete anchor [incl.]

LED UPGRADE:
 PHILIPS SMD LED 13W,
dimmable
2700K, 1055lm, EEC=A+
13kWh/1000h
LI560150



Recommended accessory:
Hanger bolt set, stainless steel
M6 thread
Ø/L: 0,6/8 cm
LI228753



OTOS PL



230V~



IP43



2,65



Socket/Lamp [excl.]:
G24d-2 / TC-D, 18W

Models:
■ silver-grey
■ anthracite

Item no.:
LI230454
LI230455

Material:
Aluminium/glass

Dimensions:
Ø/H: 17/100 cm

Accessories/Included:
Low-loss ballast [incl.]
Concrete anchor [incl.]

Recommended lamp:
18W, 2700K, 1200lm, EEC=B
22kWh/1000h
LI508218



Recommended accessory:
Hanger bolt set, stainless steel
M6 thread
Ø/L: 0,6/8 cm
LI228753



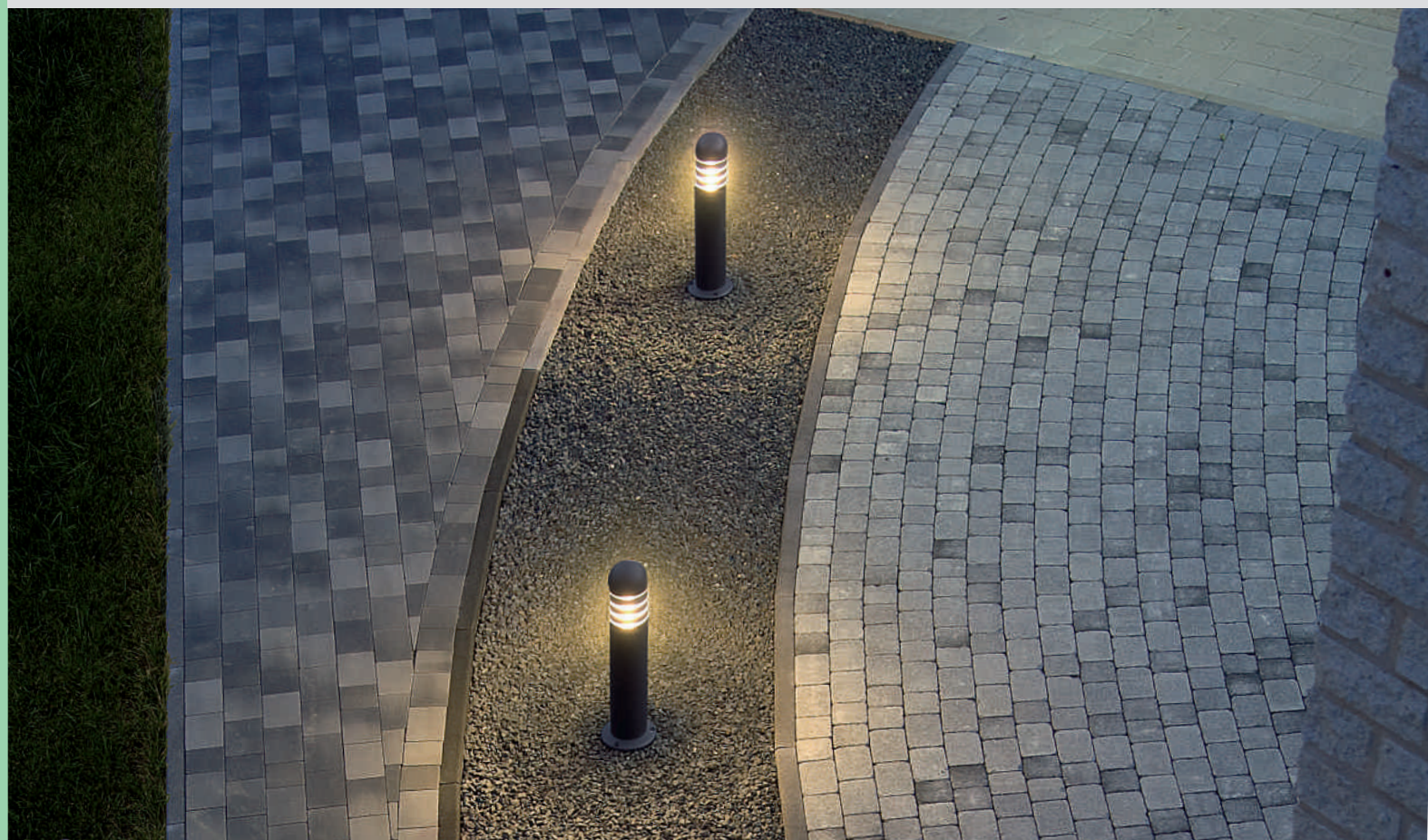



VAP 40 / 70 / 100

Stainless steel 304



230V~



IP44



Socket/Lamp [excl.]:
E27 / TC(...SE), 23W max.
up to max. Ø/L: 5,2/12,1 cm

Lamp options [excl.]:
LED

Material:
Stainless steel 304

Models:	Item no.:
■ stainless steel VAP 40	LI229054
VAP 70	LI229057
VAP 100	LI229050

Recommended lamp:

15W, 2700K, 970lm, EEC=A
15kWh/1000h
LI509012



Recommended accessory:

Connection box IP68, plastic, 3-pole,
Ø/L: 2,7/11,5 cm. For a safe
connection in the body.
LI228730



Recommended accessory:

Concrete anchor set
stainless steel 304
LI229059

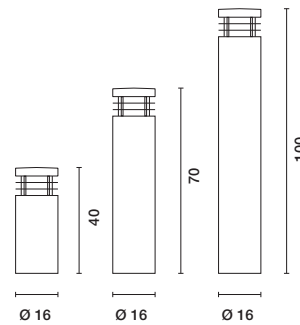

NEW POL

Ideal for unobtrusive path lighting



230V~



IP54



Socket/Lamp [excl.]:
E27 / TC(...SE), 25W max.
up to max. Ø/L: 6,2/17,5 cm

Lamp options [excl.]:
LED

Material:
Aluminium/acrylic

Accessories/Included:
Screws [excl.]

Models:	Item no.:
■ silver-grey	LI228774
■ anthracite	LI228785

Recommended lamp:

23W, 2700K, 1570lm, EEC=A
23kWh/1000h
LI509022



Recommended accessory:

Connection box IP68, plastic, 3-pole,
Ø/L: 2,7/11,5 cm. For a safe
connection in the body.
LI228730



Recommended accessory:

Hanger bolt set, stainless steel
M6 thread
Ø/L: 0,6/8 cm
LI228753

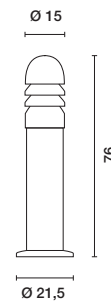



ROX ACRYL POLE 30 / 60 / 90

EEC= A-A+++ 230V~ 7-12 IP44



+ Aluminium fitting – classy appearance

636



705

Socket/Lamp [excl.]:
E27 / TC(...)
SE, 20W max.
up to max. Ø/L: 6/17 cm

Lamp options [excl.]:
LED

Material:
Aluminium/acrylic glass

Models:	Item no.:
■ alu brushed Rox Acryl Pole 30	LI232256
Rox Acryl Pole 60	LI232266
Rox Acryl Pole 90	LI232276

LED UPGRADE:
PHILIPS Corepro LED E27, 9,5W,
dimmable
2700K, 806lm, EEC=A+
10kWh/1000h
LI560161

Recommended accessory:
Earth spike, steel galvanised
Product L: 50 cm
LI231234

Recommended accessory:
Concrete anchor
set, stainless
steel 304
LI232220

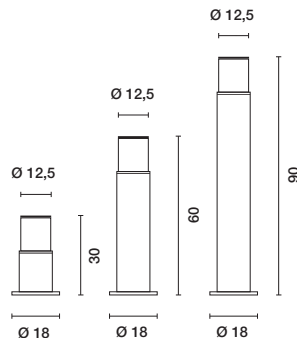



SQUARE POLE 30 / 60 / 90

EEC= A-A++ 230V~ 7-12 IP44



Aluminium fitting – classy appearance

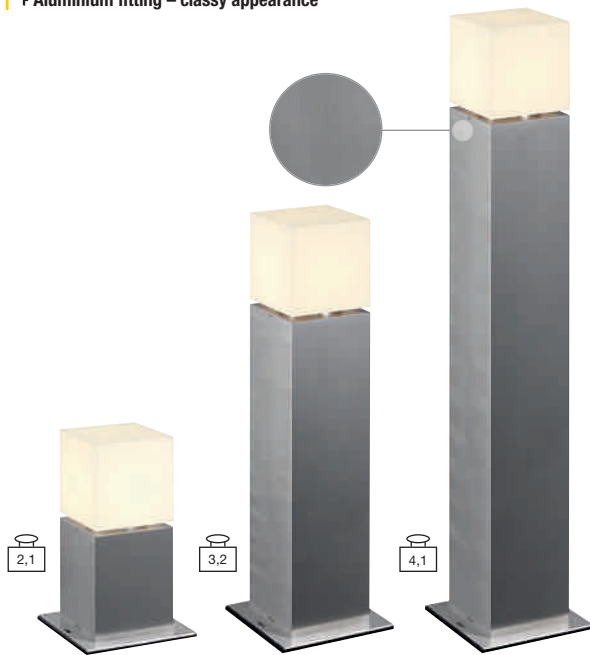

Socket/Lamp [excl.]:
E27 / TC(...).SE, 20W max.
up to max. Ø/L: 6/15 cm

Lamp options [excl.]:
LED

Material:
Aluminium/acrylic glass

Models:	Item no.:
■ alu brushed/lacquered Square Pole 30	LI232236
Square Pole 60	LI232246
Square Pole 90	LI232249

LED UPGRADE:
PHILIPS Corepro LED E27, 9,5W, dimmable
2700K, 806lm, EEC=A+
10kWh/1000h
LI560161

Recommended accessory:
Earth spike, steel galvanised
Product L: 50 cm
LI231234

Recommended accessory:
Concrete anchor set, stainless steel 304
LI232220

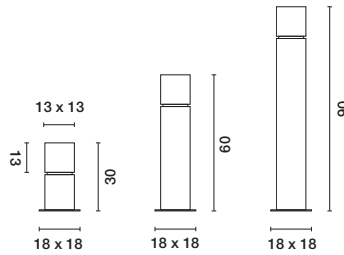

GRAFIT SL 30 / 60

EEC= A-A++ 230V~ IP44



Aluminium fitting – classy appearance



Socket/Lamp [excl.]:
E27 / TC(...).SE, 11W max.
up to max. Ø/L: 6/11,5 cm

Lamp options [excl.]:
LED

Material:
Aluminium/plastic

Accessories/Included:
Connection box [incl.]

Models:	Item no.:
■ anthracite Grafit SL 30	LI231215
Grafit SL 60	LI231225

LED UPGRADE:
PHILIPS Corepro LED E27, 9,5W, dimmable
2700K, 806lm, EEC=A+
10kWh/1000h
LI560161

Recommended accessory:
Earth spike, steel galvanised
Product L: 48 cm
LI231230

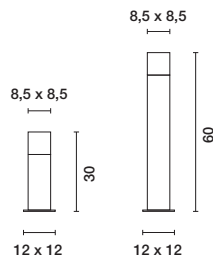





VAP LED 30 / 60

- Stainless steel 316 – highly weatherproof
- Premium LED
- Unique light/shadow effect



1 Module

100V-240V-700mA



6-13



IP44



Lamp [incl.]:
 COB LED, 6,7W max.
 Total consumption: 8,9W

Material:
 Stainless steel 316

Models:	Item no.:
■ stainless steel brushed 3000K, 320lm, CRI 80 VAP LED 30	LI231893
VAP LED 60	LI231896

NEW

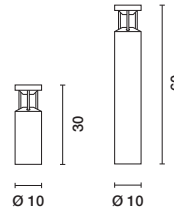

INSIDE

Recommended accessory:
 Earth spike, steel galvanised
 Product L: 48 cm
 LI230060



Recomm. accessory:
 Concrete anchor set
 stainless steel
 LI230061



VAP SLIM 30 / 60 / 90

- Stainless steel 304



230V~



10-13



IP44



Socket/Lamp [excl.]:
 E27 / TC(...).SE, 20W max.
 up to max. Ø/L: 5/13,6 cm

Lamp options [excl.]:

Material:
 Stainless steel 304

Models:	Item no.:
■ stainless steel brushed VAP Slim 30	LI230063
VAP Slim 60	LI230066
VAP Slim 90	LI230069

Recommended lamp:
 20W, 2700K, 1200lm, EEC=A
 20kWh/1000h
 LI508760



Recommended accessory:
 Earth spike, steel galvanised
 Product L: 48 cm
 LI230060



Recomm. accessory:
 Concrete anchor set
 stainless steel
 LI230061

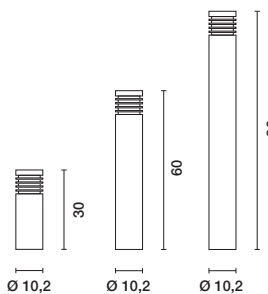





BIG NAILS PLUS 50 / 80



230V~



IP44



Stainless steel 304



Socket/Lamp [excl.]:
E27 / TC(...)SE, 23W max.
up to max. Ø/L: 4,8/14,8 cm

Lamp options [excl.]:

Material:
Stainless steel 304/acrylic glass

Models:
■ stainless steel
Big Nails Plus 50 **LI231602**
Big Nails Plus 80 **LI231612**

LED UPGRADE:
LED E27 Tube, 4,7W,
3000K, 380lm, EEC=A+
5kWh/1000h
LI551532



Recommended accessory:
Connection box IP68, plastic, 3-pole,
Ø/L: 2,7/11,5 cm. For a safe
connection in the body.
LI228730



Recommended accessory:
Earth spike, steel galvanised
Product L: 50 cm
LI227922

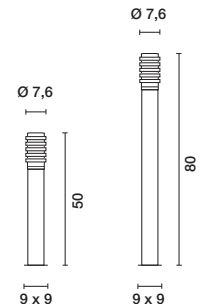

BIG NAILS 50 / 80



230V~



IP44



Stainless steel 304



Socket/Lamp [excl.]:
E27 / TC(...)SE, 15W max.
up to max. Ø/L: 4,5/17 cm

Lamp options [excl.]:

Material:
Stainless steel 304/polycarbonate

Models:
■ stainless steel
Big Nails 50 **LI229162**
Big Nails 80 **LI229172**

LED UPGRADE:
LED E27 Tube, 4,7W,
3000K, 380lm, EEC=A+
5kWh/1000h
LI551532



Recommended accessory:
Earth spike, steel galvanised
Product L: 50 cm
LI227922

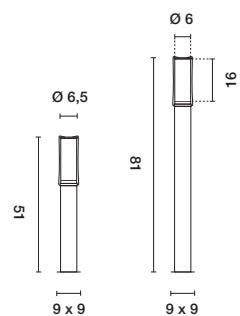





NAILS FLOOR STAND

EEC= D-A+ 230V- IP44



- + Stainless steel 304
- + Easy change of design by switching the glass insert

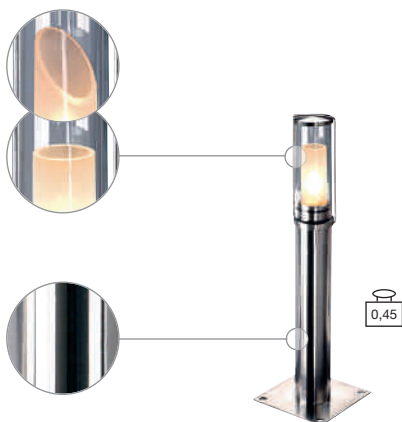

Socket/Lamp [excl.]:
G9 / QT14, 40W max.
up to max. Ø/L: 1,4/ 4,3 cm

Lamp options [excl.]:
LED Perfectfit

Material:
Stainless steel 304/glass

Accessories/Included:
Glass insert [incl.]

Models: ■ stainless steel
Item no.: LI229142

Recommended lamp:
33W ± 40W
2700K, 460lm, EEC=D
33kWh/1000h
LI519451



Recommended accessory:
Earth spike, steel galvanised
Product L: 50 cm
LI227922

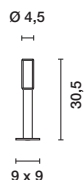

TRUST 30 / 60

EEC= A-A+ 230V- IP55



- + Stainless steel 304
- + Appearance and radiation can be changed through grid



Socket/Lamp [excl.]:
E27 / TC(...),SE, 11W max.
up to max. Ø/L: 4,8/13,9 cm

Lamp options [excl.]:
LED

Material:
Stainless steel 304/polycarbonate

Accessories/Included:
Grid [excl.]

Models: ■ stainless steel
Trust 30
Item no.: LI227932

Trust 60
Item no.: LI227962

LED UPGRADE:
LED E27 Tube, 4,7W,
3000K, 380lm, EEC=A+
5kWh/1000h
LI551532



Recommended accessory:
Connection box IP68, plastic, 3-pole,
Ø/L: 2,7/11,5 cm. For a safe
connection in the body.
LI228730



Recommended accessory:
Earth spike, steel galvanised
Product L: 50 cm
LI227922



Recommended accessory:
Grid, stainless steel 304
Ø/H: 8/10 cm
LI227952

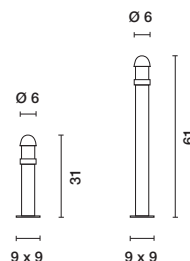



SLOTS 45 / 65



+ Indirect light emission provides special effect
+ Premium LED

Lamp [incl.]:
LED COB LED
340lm
Total consumption: 6,3W

Models:
3000K, CRI>80
Slots 45
■ anthracite
■ rust

Item no.:
LI231815
LI231817

Material:
Aluminium

Accessories/Included:
Concrete anchor set [incl.]

Slots 65
■ anthracite
■ rust

LI231455
LI231457



The LED module is built into the path light's head piece and radiates downwards so that glare is effectively reduced.

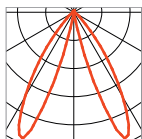

1,13



1,37

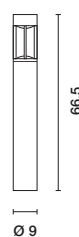
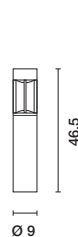

INSIDE

Recommended accessory:
Connection box IP68, plastic, 3-pole,
Ø/L: 2,7/11,5 cm. For a safe
connection in the body.
LI228730



Recommended accessory:
Hanger bolt set, stainless steel
M6 thread
Ø/L: 0,6/8 cm
LI228753





+ QUADRASYL SL 75

EEC= B-A++ 230V~ IP44



Socket/Lamp [excl.]:
GX53 / Ø TCR-TSE, 11W max.
up to max. Ø/H: 7,5/2,7 cm

Models:
■ silver-grey
■ anthracite

Item no.:
LI232294
LI232295

Lamp options [excl.]:
LED

Material:
Aluminium

Accessories/Included:
Concrete anchor set [incl.]

LED UPGRADE:
LED GX53, 3W, 120°
3000K, 250lm, EEC=A++
3kWh/1000h
LI551372



Recommended accessory:
Connection box IP68, plastic, 3-pole,
Ø/L: 2,7/11,5 cm. For a safe
connection in the body.
LI228730

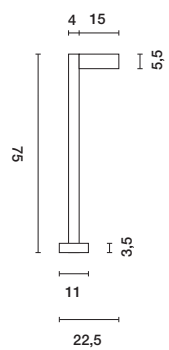





BERRA 30 / 50 / 70

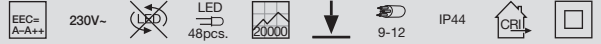

Lamp [incl.]:
 SMD LED, 4W
 Total consumption: 5W

Material:
 Aluminium/plastic

Accessories/Included:
 Connection box [incl.]

Models:	Item no.:
anthracite 4000K, 320lm, CRI>70 Berra 30	LI231283
Berra 50	LI231285
Berra 70	LI231287



Recommended accessory:
 Earth spike, steel galvanised
 Product L: 48 cm
 LI230060



Recomm. accessory:
 Concrete anchor set
 stainless steel
 LI230061

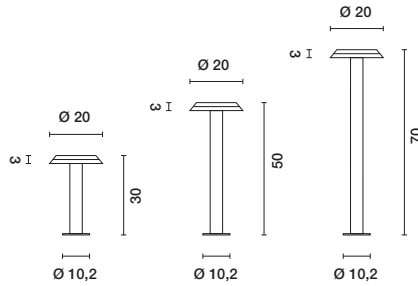

GLOO PURE 27 / 44 / 70



Genuine glass
 637
 705



Socket/Lamp [excl.]:
 E27 / TC(...)SE, 20W max.
 up to max. Ø/L: 4,8/18 cm

Lamp options [excl.]:

Material:
 Aluminium/glass

Note:
 Gloo Pure 27 can be applied as
 ceiling or floor light.

Models:	Item no.:
white/anthracite Gloo Pure 27	LI232015
Gloo Pure 44	LI232025
Gloo Pure 70	LI232035

Recommended lamp:
 20W, 2700K, 1200lm, EEC=A
 20kWh/1000h
 LI508760



Recommended accessory:
 Connection box IP68, plastic, 3-pole,
 Ø/L: 2,7/11,5 cm. For a safe
 connection in the body.
 LI228730



Recommended accessory:
 Earth spike, steel galvanised
 Product L: 50 cm
 LI231234

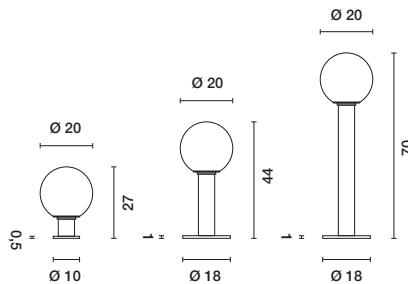





ALPA MUSHROOM 40 / 75



230V~



IP55



Socket/Lamp [excl.]:
E27 / TC(...)SE, 24W max.
up to max. Ø/L: 5,2/16 cm

Lamp options [excl.]:

Material:
Aluminium/polycarbonate

Accessories/Included:
Screws [excl.]

Note:
For a safe connection in the body we recommend connection box [LI228730].

Models:
Alpa Mushroom 40
■ silver-grey **LI228932**
■ stone grey **LI228935**

Alpa Mushroom 75
■ silver-grey **LI228942**
■ stone grey **LI228945**

Recommended lamp:
23W, 2700K, 1450lm, EEC=A
23kWh/1000h
LI508770



Recommended accessory:
Connection box IP68, plastic, 3-pole,
Ø/L: 2,7/11,5 cm. For a safe
connection in the body.
LI228730



Recommended accessory:
Earth spike, steel galvanised
Ø/H: 14/37 cm
LI228722



Recomm. accessory:
Concrete anchor set,
stainless steel
M6 thread,
Product L: 20 cm
LI228712



ALPA CONE 75 / 100



230V~



IP55



Socket/Lamp [excl.]:
E27 / TC(...)SE, 24W max.
up to max. Ø/L: 5,2/17,5 cm

Lamp options [excl.]:

Material:
Aluminium/polycarbonate

Accessories/Included:
Screws [excl.]

Note:
For a safe connection in the body we recommend connection box [LI228730].

Models:
Alpa Cone 75
■ silver-grey **LI228912**
■ stone grey **LI228915**

Alpa Cone 100
■ silver-grey **LI228922**
■ stone grey **LI228925**

Recommended lamp:
23W, 2700K, 1450lm, EEC=A
23kWh/1000h
LI508770



Recommended accessory:
Connection box IP68, plastic, 3-pole,
Ø/L: 2,7/11,5 cm. For a safe
connection in the body.
LI228730



Recommended accessory:
Earth spike, steel galvanised
Ø/H: 14/37 cm
LI228722



Recomm. accessory:
Concrete anchor set,
stainless steel
M6 thread,
Product L: 20 cm
LI228712





+ PLENUM® FIX

+ Individual adjustment of height through optional extension rod



230V~



IP44



Socket/Lamp [excl.]:
E27 / TC(...)SE, 25W max.
up to max. Ø/L: 5,2/17,3 cm

Lamp options [excl.]:

Material:
Aluminium/polycarbonate

Note:
The height of the fitting can be extended by 1 extension rod max.

Models:
 white/white **LI228951**
 anthracite/white **LI228955**

Item no.:
LI228951
LI228955

Recommended lamp:
15W, 2700K, 970lm, EEC=A
15kWh/1000h
LI509012



Recommended accessory:
Earth spike, steel galvanised
Ø/H: 14/37 cm
LI228722



Recommended accessory:
Concrete anchor set, stainless steel
M6 thread,
Product L: 20 cm
LI228712



Recommended accessory:
Hanger bolt set, stainless steel
M6 thread
Ø/L: 0,6/8 cm
LI228752



Recommended accessory:
Extension rod, Aluminium
Ø/L: 3/46 cm
 white **LI228958**
 anthracite **LI228959**





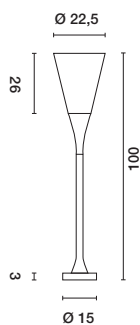

1,55





SITRA 360 SL

EEC= B-A++ 230V~ 90° 6-12 IP44

-  607
-  615
-  692
-  706

Adjustable lamp head

Socket/Lamp [excl.]:
GX53 / Ø TCR-TSE, 2x 9W max.
up to max. Ø/H: 7,5/3,5 cm

Models:
■ stone grey
■ anthracite

Item no.:
LI231504
LI231505

Lamp options [excl.]:
LED

Material:
Aluminium/glass

LED UPGRADE:
LED GX53, 3W, 120°
3000K, 250lm, EEC=A++
3kWh/1000h
LI551372

Recommended accessory:
Earth spike, steel galvanised
Product L: 48 cm
LI230060

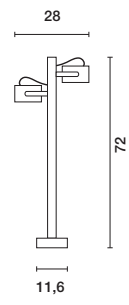



The New Myra 1 und 2 lamp heads can be individually applied as floor stands or spike lights with the accessories floor base or end piece/earth spike.



+ NEW MYRA 1 / 2 Lamp head

EEC= B-A++ 230V~ +A 340° 45° IP44

+ Can be extended individually

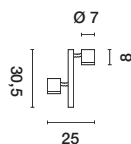
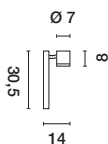
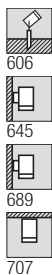

Socket/Lamp [excl.]:
 GU10 / LED GU10 51 mm,
 4,5W max. [LI233174/-5]
 2x 4,5W max. [LI233184/-5]
 up to max. Ø/L: 5/5,7 cm

Material:
 Aluminium

Dimensions:
 Connection lead L: 3 m

Note:
 Connection lead: open cable end.
 The height of the fitting can be
 extended by 2 extension rods max.

Models:
 New Myra 1
 ■ silver-grey LI233174
 ■ anthracite LI233175

New Myra 2
 ■ silver-grey LI233184
 ■ anthracite LI233185

LED UPGRADE:
PHILIPS Corepro LED 4,5W, 36°
 2700K, 345lm, EEC=A+
 5kWh/1000h
 LI560182



Recommended accessory:
 Hanger bolt set, stainless steel
 M6 thread
 Ø/L: 0,6/8 cm
 LI228752



Recomm. accessory:
 Concrete anchor set,
 stainless steel
 M6 thread,
 Product L: 20 cm
 LI228712



Recommended accessory:
 Extension rod, aluminium
 Use 2 pcs. max. per fitting.
 Ø/L: 3/31 cm
 ■ silver-grey LI233164
 ■ anthracite LI233165



Recommended accessory:
 Floor base, aluminium
 Ø/H: 15/11,5 cm
 ■ silver-grey LI233144
 ■ anthracite LI233145



Recommended accessory:
 Earth spike, steel galvanised
 Ø/H: 14/37 cm
 LI228722





[LI231035] | page 615



[LI227418] | page 613

POLLARD SPIKE LIGHTS



ROD SPIKE LIGHTS - SINGLE SPOT

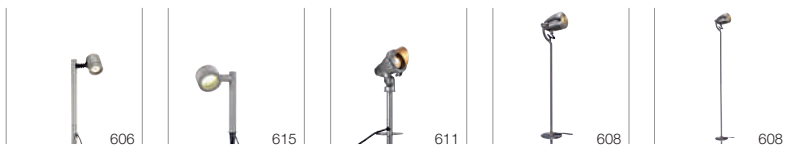

ROD SPIKE LIGHTS - MULTI SPOT

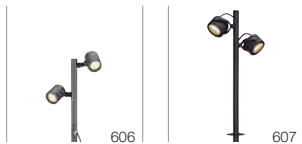

SPOT SPIKE LIGHTS

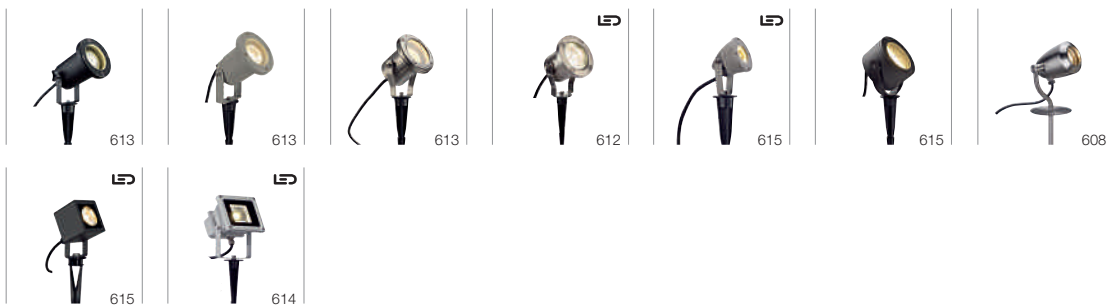



NEW MYRA 1 / 2 Lamp head



230V~



340°



45°

IP44



603



645



688+



707



0,4

1,1

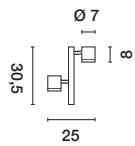
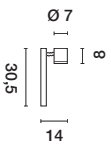

Socket/Lamp [excl.]:
GU10 / GU10 51 mm,
4,5W max. [LI233174/-5]
2x 4,5W max. [LI233184/-5]
up to max. Ø/L: 5/5,7 cm

Material:
Aluminium

Dimensions:
Connection lead L: 3 m

Note:
Connection lead: open cable end
The height of the fitting can be increased by 2 extension rods max.

Models:
New Myra 1
■ silver-grey
■ anthracite

Item no.:
LI233174
LI233175

New Myra 2
■ silver-grey
■ anthracite

LI233184
LI233185



Recommended accessory:

Extension rod, aluminium
2 pcs. max. per fitting.
Ø/L: 3/31 cm
■ silver-grey LI233164
■ anthracite LI233165



Recommended accessory:

End piece/earth spike, aluminium
Ø/L: 3/31 cm
■ silver-grey LI233154
■ anthracite LI233155







LED UPGRADE:

SMD LED 4,3W, 40°
3000K, 245lm, EEC=A+
5kWh/1000h
LI551253





SITRA 360 SL SPIKE

-  601
-  615
-  692
-  706

Adjustable lamp heads

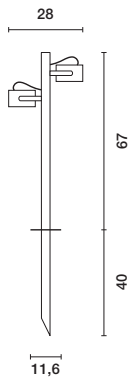

EEC= B-A++ 230V~ 90° IP44

Socket/Lamp [excl.]:
GX53 / TCR-TSE, 2x 9W max.
up to max. Ø/H: 7,5/3,5 cm

Models:
■ anthracite

Item no.:
LI231535

Lamp options [excl.]:
LED

Material:
Aluminium/glass

Dimensions:
Connection lead L: 1,5 m

Accessories/Included:
Mains plug: IP safety plug [incl.]

LED UPGRADE:
LED GX53, 3W, 120°
3000K, 250lm, EEC=A++
3kWh/1000h
LI551372



LED UPGRADE:
LED GX53 4,2W, 35°
3000K, 200lm, EEC=A
5kWh/1000h
LI550092





CV-SPOT 40 / 80 / 120



Stainless steel

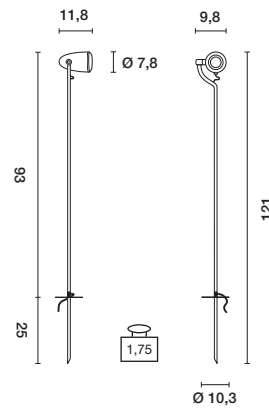
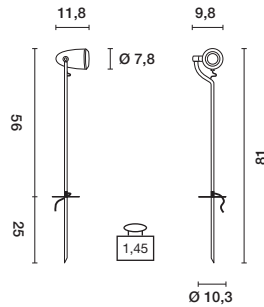
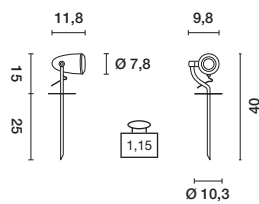

EEC= A-A++ 230V- 180° IP65

Socket/Lamp [excl.]:
GU10 / LED GU10 51 mm, 4W max.
up to max. Ø/L: 5/5,7 cm

Material:
Stainless steel 304

Dimensions:
Connection lead L: 2 m

Accessories/Included:
Mains plug: IP safety plug [incl.]

Note:
Lamp head can be adjusted and fixed using an allen key.

Models:	Item no.:
■ stainless steel brushed	
40 cm	LI231672
80 cm	LI231682
120 cm	LI231692

LED UPGRADE:
PHILIPS Corepro LED Spot 3,5W, 36°
3000K, 245lm, EEC=A+
4kWh/1000h
LI560084







NAILS SPIKE

EEC= D-A+ 230V~ 1,4 IP44



+ Stainless steel; easy change of design by turning over the glass insert

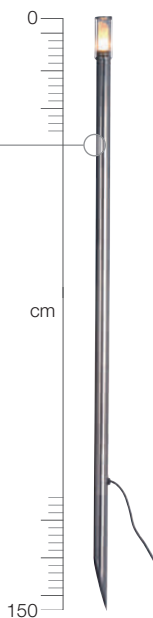
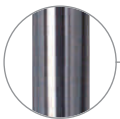

Socket/Lamp [excl.]:
G9/ QT14, 40W max.
up to max. Ø/L: 1,4/ 4,3 cm

Lamp options [excl.]:
Perfectfit

Material:
Stainless steel 304

Dimensions:
Connection lead L: 1,5 m

Accessories/Included:
Mains plug: IP safety plug [incl.]
Glass insert [incl.]

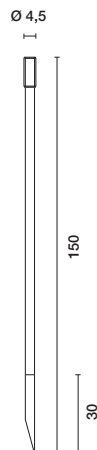

Models:

■ stainless steel

Item no.:

L1229152

Recommended lamp:

33W ≈ 40W
2700K, 460lm, EEC=D
33kWh/1000h
L1519451



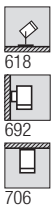

EASYLITE® SPIKE GU10

Note:
Lamp head can be adjusted and fixed using an allen key.



Socket/Lamp [excl.]:
GU10 / QPAR51, 50W max.
up to max. Ø/L: 5/5,7 cm

Lamp options [excl.]:
LED

Material:
Aluminium

Dimensions:
Product H: 45,5 cm
Head Ø/L: 10/15 cm
Spike H: 15 cm
Connection lead L: 1,2 m

Accessories/Included:
Mains plug: IP safety plug [incl.]

Models:
■ stone grey

Item no.:
LI230545

LED UPGRADE:
LED GU10 4,3W, 40°
2700K, 245lm, EEC=A+
5kWh/1000h
LI551252





NAUTILUS LED 304S



100V-240V-350mA



LED 1 Module



IP55



+ Stainless steel
+ Premium LED



617
692
706



Lamp [incl.]:

PowerLED, 3x 1W
Total consumption: 4,5W

Material:
Stainless steel 304

Dimensions:
Connection lead L: 1,5 m

Accessories/Included:
LED driver [incl.]
Mains plug: IP safety plug [incl.]
Plastic spike [incl.]

Models:

3000K, 240lm, CR 80

■ stainless steel brushed **LI230812**

Item no.:

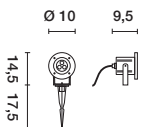



NAUTILUS SPIKE Stainless steel



230V~



IP55



† Stainless steel 316



Socket/Lamp [excl.]:

GU10 / QPAR51, 35W max.
up to max. Ø/L: 5/5,7 cm

Lamp options [excl.]:



Material:

Stainless steel 316

Dimensions:

Connection lead L: 1,5 m

Accessories/Included:

Mains plug: IP safety plug [incl.]
Plastic spike [incl.]

Models:

■ stainless steel brushed

Item no.:

LI229740

LED UPGRADE:

LED GU10 4,3W, 40°
2700K, 245lm, EEC=A+
5kWh/1000h
LI551252



NAUTILUS SPIKE 3 m connection lead without plug



230V~



IP65



Socket/Lamp [excl.]:

GU10 / QPAR51, 35W max.
up to max. L: 5,7 cm

Lamp options [excl.]:



Material:

Aluminium

Dimensions:

Connection lead L: 3 m

Accessories/Included:

Plastic spike [incl.]

Note:

Connection lead: open cable end.

Models:

■ silver-grey

Item no.:

LI227419

LED UPGRADE:

LED GU10 4,3W, 40°
2700K, 245lm, EEC=A+
5kWh/1000h
LI551252



NAUTILUS SPIKE 1,5 m connectin lead with plug



230V~



IP65



Socket/Lamp [excl.]:

GU10 / QPAR51, 35W max.
up to max. L: 5,7 cm

Lamp options [excl.]:



Material:

Aluminium

Dimensions:

Connection lead L: 1,5 m

Accessories/Included:

Mains plug: IP safety plug [incl.]
Plastic spike [incl.]

Models:

■ silver-grey

Item no.:

LI227418

LED UPGRADE:

LED GU10 4,3W, 40°
2700K, 245lm, EEC=A+
5kWh/1000h
LI551252



NAUTILUS SPIKE XL



230V~



IP65



† Extended body XL for longer LED lamps



Socket/Lamp [excl.]:

GU10 / GU10 51 mm, 11W max.
up to max. Ø/L: 5/8,3 cm

Material:

Aluminium

Dimensions:

Connection lead L: 1,5 m

Accessories/Included:

Mains plug: IP safety plug [incl.]
Plastic spike [incl.]

Models:

■ black

Item no.:

LI227410

LED UPGRADE:

LED GU10 4,3W, 40°
2700K, 245lm, EEC=A+
5kWh/1000h
LI551252





LED OUTDOOR BEAM 10W



230V~



LED
1 pce.



Lamp [incl.]:
LED COB LED, 10W
Total consumption: 12,8W

Material:
Aluminium/glass

Dimensions:
Connection lead L: 2 m

Accessories/Included:
LED driver [incl.]
Mains plug: IP safety plug [incl.]

Note:
We recommend using an earth spike to fix into the ground [excl.].

Models:
■ silver-grey
5700K, 750lm, CRI>70 **LI231101**
3000K, 750lm, CRI>70 **LI231102**

Item no.:



Recommended accessory:
Earth spike, plastic, black
Spike L: 17,5 cm
LI900011





NAUTILUS SQUARE LED

100V-
~240V-
700mALED
1 pce.

+ Premium LED

**Lamp [incl.]:**

LED COB LED, 6,7W
Total consumption: 9W

Material:

Aluminium/glass

Dimensions:

W/H/D: 8/33/7 cm
Connection lead L: 2 m

Accessories/Included:

Mains plug: IP safety plug [incl.]
Plastic spike [incl.]
LED driver [incl.]

Models:

3000K, 520lm, CRI 80
■ anthracite

Item no.:

LI231035

NAUTILUS SPIKE LED COMPACT



230V~

LED
1 pce.**Lamp [incl.]:**

LED PowerLED, 3,3W
Total consumption: 4,3W

Material:

Aluminium

Dimensions:

Connection lead L: 1,5 m

Accessories/Included:

Mains plug: IP safety plug [incl.]
Plastic spike [incl.]

Models:

3000K, 100lm, CRI 80
■ silver-grey
■ anthracite

Item no.:

LI231022

LI231025

SITRA 360 SPIKE



230V~



601



607



692

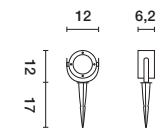

706

**Socket/Lamp [excl.]:**

GX53 / TCR-TSE, 9W max.
up to max. Ø/H: 7,5/3,5 cm

Lamp options [excl.]:
Material:

Aluminium/glass

Dimensions:

Connection lead L: 1,5 m

Accessories/Included:

Mains plug: IP safety plug [incl.]
Plastic spike [incl.]

Models:

■ anthracite

Item no.:

LI231525

LED UPGRADE:

LED GX53, 3W, 120°
3000K, 250lm, EEC=A++
3kWh/1000h
LI551372



SITRA EARTH SPIKE



230V~



643

**Socket/Lamp [excl.]:**

GX53 / TCR-TSE, 9W max.
up to max. Ø/H: 7,5/3,5 cm

Lamp options [excl.]:
Material:

Aluminium/glass

Dimensions:

W/H/D: 17/27/10 cm
Connection lead L: 1,5 m

Accessories/Included:

Mains plug: IP safety plug [incl.]
Plastic spike [incl.]

Models:

■ anthracite
■ stone grey

Item no.:

LI230374

LI230375



LED UPGRADE:

LED GX53, 3W, 120°
3000K, 250lm, EEC=A++
3kWh/1000h
LI551372





SPOTS

- | | | | | | | |
|---|---|---|---|---|--|---|
|  |  |  |  |  |  |  |
| 618 | 618 | 619 | 617 | 618 | 619 | 617 |

LED

NEW

LED

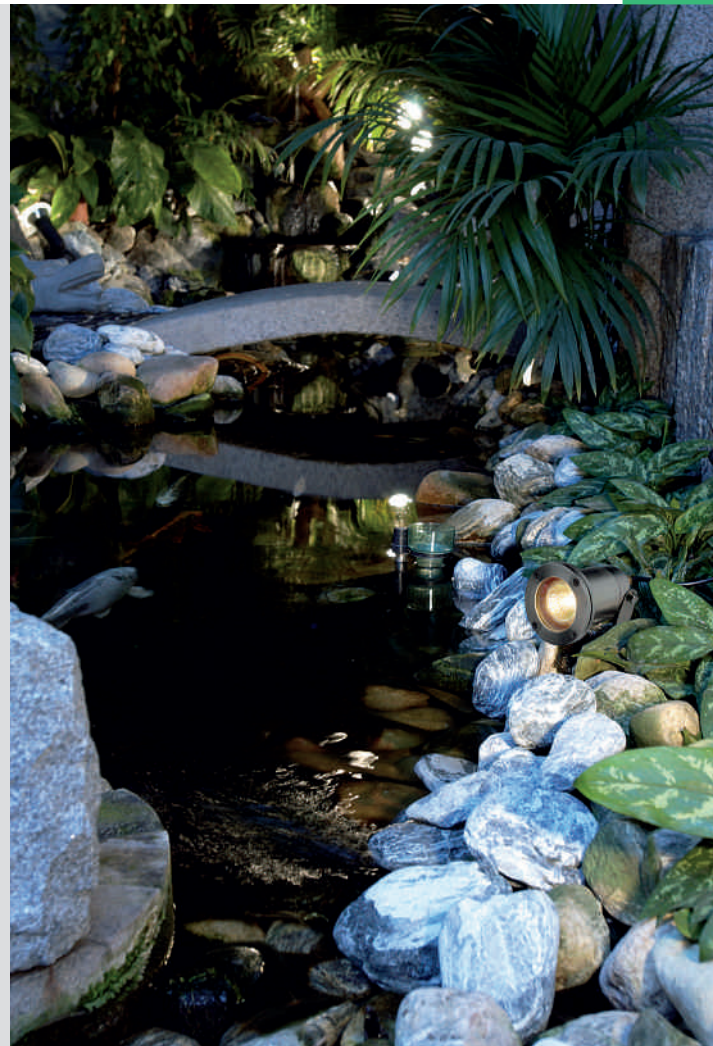

+
+
+
NAUTILUS LED 304B
EEC= A-A++
100V-240V- 350mA
LED 1 Module
80000
360°
270°
7
45°
0,66
IP55
⏚

- + Stainless steel
- 612
- 692
- 706



Lamp [incl.]:
 LED PowerLED, 3x 1W
 Total consumption: 4,5W

Material:
 Stainless steel 304

Dimensions:
 Connection lead L: 1,5 m

Accessories/Included:
 LED driver [incl.]

Note:
 Connection lead: open cable end.

Models: Item no.:
 3000K, 240lm, CRI 80
■ stainless steel brushed **LI230802**



+
+
SPOODI

EEC= A-A++
230V~
LED 1 Module
80000
180°
90°
0,66
IP55
⏚



Lamp [incl.]:
 LED COB LED, 8,3W
 Total consumption: 10W

Material:
 Aluminium/glass

Dimensions:
 W/H/D: 14,7/2,7/12 cm
 Connection lead L: 2 m

Accessories/Included:
 LED driver [incl.]
 Mains plug: IP safety plug [incl.]

Models: Item no.:
 3000K, 760lm, CRI>80
■ black **LI232800**
■ silver-grey **LI232804**



**NAUTILUS PAR38**

+ Stainless steel

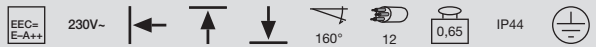
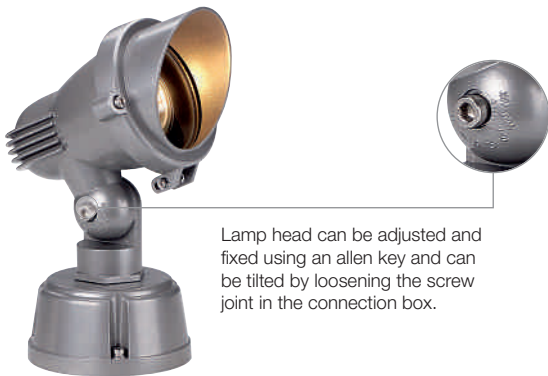
**Socket/Lamp [excl.]:**
E27 / QPAR38, 80W max.**Lamp options [excl.]:**
QTOPAR38-SE**Material:**
Stainless steel 304**Dimensions:**
Product H: 25 cm
Head Ø: 15,5 cm
Connection lead L: 1,5 m**Note:**
Connection lead: open cable end.**Models:**
■ stainless steel**Item no.:**
LI229100**Recommended lamp:**
80W, 30°, 2700K, 670lm, EEC=D
80kWh/1000h
▼ LI519760**EASYLITE® SPOT GU10**611
692
706

Lamp head can be adjusted and fixed using an allen key and can be tilted by loosening the screw joint in the connection box.

Socket/Lamp [excl.]:
GU10 / QPAR51, 50W max.**Lamp options [excl.]:**
LED**Material:**
Aluminium/glass**Dimensions:**
Product H: 20 cm
Head Ø/L: 10/15 cm
Base Ø/H: 10/5 cm**Models:**
■ stone grey**Item no.:**
LI230525**LED UPGRADE:**
LED GU10 4,3W, 40°
2700K, 245lm, EEC=A+
5kWh/1000h
LI551252**Recommended accessory:**
Earth spike, plastic, black
Spike L: 25 cm
LI230630



NAUTILUS IP67



Socket/Lamp [excl.]:
G5,3 / \leq QR-CBC51, 35W max.

Models:
■ silver-grey

Item no.:
LI227500

Lamp options [excl.]:
 \leq QR-C51 /

Material:
Aluminium/glass

Dimensions:
Product H: 10 cm
Head \varnothing : 9,7 cm
Connection lead L: 3 m

Accessories/Included:
Transformer [excl.]
Earth spike [excl.]

Note:
Connection lead: open cable end.

LED UPGRADE:
LED MR16 3,8W
2700K, 225lm, EEC=A+
5kWh/1000h
LI551242



Recommended accessory:
Earth spike, plastic, black
Spike L: 17,5 cm
LI900011



Recommended connection:
IP44 conventional transformer,
60VA/12V~
LI227160



NAUTILUS MR16

† Stainless steel



Socket/Lamp [excl.]:
G5,3 / \leq QR-CBC51, 35W max.

Models:
■ stainless steel

Item no.:
LI229090

Lamp options [excl.]:
 \leq QR-C51 /

Material:
Stainless steel 304/glass

Dimensions:
Product \varnothing /H: 10/12,5 cm
Head \varnothing : 9 cm
Connection lead L: 1,5 m

Accessories/Included:
Transformer [excl.]

Note:
Connection lead: open cable end.

LED UPGRADE:
LED MR16 3,8W
3000K, 225lm, EEC=A+
5kWh/1000h
LI551243



Recommended connection:
IP44 conventional transformer,
60VA/12V~
LI227160



NAUTILUS GX53 STAINLESS

† Stainless steel



Socket/Lamp [excl.]:
GX53 / \varnothing TCR-TSE, 11W max.
up to max. \varnothing /H: 7,5/4 cm

Models:
■ stainless steel

Item no.:
LI229730

Lamp options [excl.]:

Material:
Stainless steel 304

Dimensions:
Product H: 17 cm
Head \varnothing /L: 14,3/8,5 cm
Base \varnothing : 9,5 cm
Connection lead L: 1,5 m

Accessories/Included:
Mains plug: IP safety plug [incl.]

LED UPGRADE:
SMD LED 7,5W, 25°
3000K, 450lm, EEC=A
8kWh/1000h
LI550082



Recommended accessory:
Earth spike, plastic, black
Spike L: 17,5 cm
LI900011





FLOOD LIGHTS





LED STRIP OUTDOOR



Lamp [incl.]:
 SMD LED
 6,3W [LI552310]
 12W [LI552320]

Material:
 Aluminium

Dimensions:
 W/H/D: 51,3/2,5/2 cm [LI552310]
 W/H/D: 101/2,5/2 cm [LI552320]

Accessories/Included:
 Power supply unit [excl.]
 Fixation [excl.]

Note:
 From 50W a new feed-in required.

Models:
 4000K, CRI 80
 50 cm 500lm
 100 cm 1000lm

Item no.:
 LI552310
 LI552320



Recommended connection:
 Power supply unit 36W, 24V=
 LI470544

Recommended connection:
 Power supply unit 60W, 24V=
 LI470506

Recommended accessory:
 Connection cable IP67,
 50W max., 2-pole
 Cable L: 1 m
 LI552331

Recommended accessory:
 Feed-in cable IP67,
 50W max., 2-pole
 Cable L: 5 m
 LI552330

Recommended accessory:
 Mounting clips, 10 pcs.
 LI552332

GALEN LED PROFILE 1 m



+ Premium LED
 + Dimmable in combination with [470660]

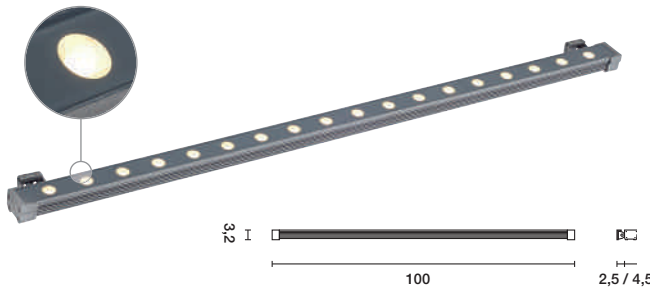

Lamp [incl.]:
 PowerLED, 18x 1W

Material:
 Aluminium/glass

Dimensions:
 Connection lead L: 1,5 m

Accessories/Included:
 Power supply unit [excl.]
 Fixation [incl.]

Models:
 silver-grey
 6500K, 1070lm, CRI 70
 3000K, 970lm, CRI 80

Item no.:
 LI229481
 LI229482



Recommended connection:
 Power supply unit 36W, 24V=
 LI470544

Recommended connection:
 Power supply unit 60W, 24V=
 LI470506

GALEN LED PROFILE



+ Premium LED
 Dimmable in combination with [464150]

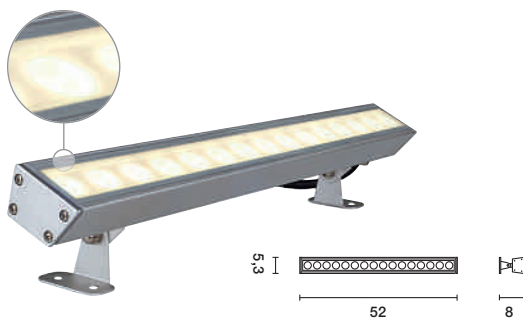

Lamp [incl.]:
 PowerLED, 15x 1W

Material:
 Aluminium/glass

Dimensions:
 Connection lead L: 1,5 m

Accessories/Included:
 LED driver [excl.]
 Fixation [incl.]

Models:
 alu anodised
 6500K, 890lm, CRI 70
 3000K, 810lm, CRI 80

Item no.:
 LI229461
 LI229462



Recommended connection:
 LED driver 18W, 350mA
 Socket for mini plug [incl.]
 LI464111

Recommended connection:
 LED driver 18W, 350mA
 dimmable
 LI464150

FLOODI (RF)

EEC= A-A++ 230V~ (LED) LED 1 pce. 80000 90° 100° ta -20°~+40° 2,77 IP65

- + RGB LED, colour-controllable
- + Easy Control via remote control
- + Stand-alone version



Lamp [incl.]:
 LED COB LED, 3in1 RGB, 30W
 Total consumption: 39W

Models:
 ■ silver-grey
 RGB, colour-controllable **LI231119**

Material:
 Aluminium/glass

Dimensions:
 Connection lead L: 2 m

Accessories/Included:
 Mains plug: IP safety plug [incl.]
 Remote control [incl.]

Note:
 With built-in RF controller and remote control incl. battery CR2025, max. coverage of remote control about 10 m.



RGB FLOOD 30W

EEC= A-A++ 230V~ (LED) LED 1 pce. 80000 90° 100° 2,3 IP65

- + RGB LED, colour-controllable
- + Operation with LIM[®]2 controller



Lamp [incl.]:
 LED COB LED, 3in1 RGB, 30W
 Total consumption: 37W

Models:
 ■ silver-grey, 1-10V
 RGB, colour-controllable **LI231113**

Material:
 Aluminium/glass

Dimensions:
 Connection lead L: 2 m

Accessories/Included:
 LED driver [incl.]
 PWM converter [incl.]
 Control line 2 m [incl.]
 Mains plug: IP safety plug [incl.]
 Controller [excl.]

Note:
 For connection with LIM[®]2 controller.



Recomm. connection:
 LIM[®]2 controller
 4x 1-10V control signal
LI470531

Recomm. accessory:
 Remote control for LIM[®]2 controller
LI470530

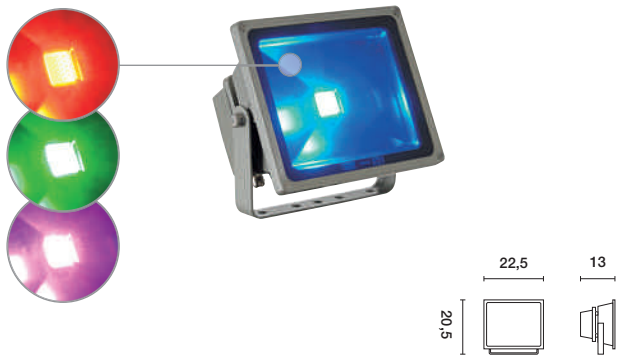

LED OUTDOOR BEAM 30W

EEC= A-A++ 230V~ (LED) LED 1 pce. 80000 90° 100° 2,2 IP65

- + RGB LED, colour-controllable
- + Operation with LIM[®]2 controller



Lamp [incl.]:
 LED COB LED, 30W
 Total consumption: 35W

Models:
 ■ silver-grey
 5700K, 3000lm, CRI>70 **LI231111**
 3000K, 2600lm, CRI>70 **LI231112**

Material:
 Aluminium/glass

Dimensions:
 Connection lead L: 2 m

Accessories/Included:
 LED driver [incl.]
 Mains plug: IP safety plug [incl.]

Note:
 We recommend fixation on the ground with **two** earth spikes [excl.].



Recommended accessory:
 Earth spike, plastic, black
 Spike L: 17,5 cm
LI900011





+
+
LED OUTDOOR BEAM 10W
EEC= A-A++
230V~
LED
1 pce.
80000
←
↓
↑
↗
90°
100°
⌂
IP65
⊕



Lamp [incl.]:
 LED COB LED, 10W
 Total consumption: 12,8W

Material:
 Aluminium/glass

Dimensions:
 Connection lead L: 2 m

Accessories/Included:
 LED driver [incl.]
 Mains plug: IP safety plug [incl.]

Note:
 We recommend fixation on the ground by earth spike [excl.].

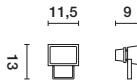

Models: **Item no.:**
 ■ silver-grey 5700K, 750lm, CRI>70 **LI231101**
 3000K, 750lm, CRI>70 **LI231102**



Recommended accessory:
 Earth spike, plastic, black
 Spike L: 17,5 cm
LI900011



+
+
LED OUTDOOR BEAM 50W
EEC= A-A++
230V~
LED
1 pce.
80000
←
↓
↑
↗
90°
100°
⌂
IP65
⊕



Lamp [incl.]:
 LED COB LED, 50W
 Total consumption: 56W

Material:
 Aluminium/glass

Dimensions:
 Connection lead L: 2 m

Accessories/Included:
 LED driver [incl.]
 Mains plug: IP safety plug [incl.]

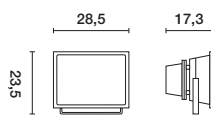

Models: **Item no.:**
 ■ silver-grey 5700K, 5100lm, CRI>70 **LI231121**
 3000K, 4500lm, CRI>70 **LI231122**





LED FLOOD LIGHT 10W

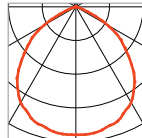
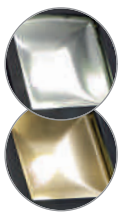

Lamp [incl.]:
 LED COB LED, 10W
 Total consumption: 12W

Material:
 Aluminium/glass

Dimensions:
 Connection lead L: 2 m

Accessories/Included:
 LED driver [incl.]
 Mains plug: IP safety plug [incl.]

Note:
 We recommend fixation on the ground by earth spike [excl.].

Models:
 ■ black
 5700K, 800lm, CRI>70 **LI231151**
 3000K, 690lm, CRI>70 **LI231152**

Item no.:



Recommended accessory:
 Earth spike, plastic, black
 Spike L: 17,5 cm
LI900011

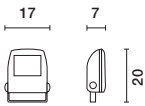

LED FLOOD LIGHT 30W

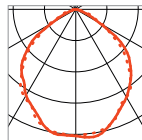
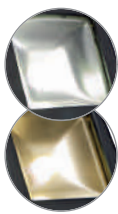

Lamp [incl.]:
 LED COB LED, 30W
 Total consumption: 36W

Material:
 Aluminium/glass

Dimensions:
 Connection lead L: 2 m

Accessories/Included:
 LED driver [incl.]
 Mains plug: IP safety plug [incl.]

Note:
 We recommend fixation on the ground with **two** earth spikes [excl.].

Models:
 ■ black
 5700K, 2400lm, CRI>70 **LI231161**
 3000K, 2100lm, CRI>70 **LI231162**

Item no.:



Recommended accessory:
 Earth spike, plastic, black
 Spike L: 17,5 cm
LI900011

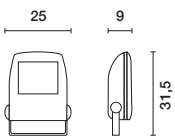

LED FLOOD LIGHT 80W

✦ For professional application – high luminous flux

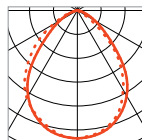

Lamp [incl.]:
 LED COB LED, 2x 40W
 Total consumption: 82,3W

Material:
 Aluminium/glass

Accessories/Included:
 LED driver [incl.]

Models:
 ■ black
 5700K, 5650lm, CRI>70 **LI231175**
 3000K, 5600lm, CRI>70 **LI231173**

Item no.:

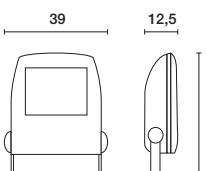





The HIT outdoor flood lights are equipped with standard safety glass. In order to guarantee UV protection, lamps with UV filter glass against harmful UV rays must be used. Lamps ordered from us are by default equipped with UV protection. For further questions regarding UV protection, we are happy to be of help.

SXL HIT-DE FLOODLIGHT 70W
asymmetrical

EEC= A~A+ 230V~ Ballast EEL=A0 90° 10 IP65

For professional application

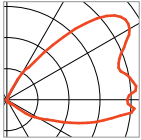

Socket/Lamp [excl.]:
Rx7s / HIT-DE, 70W

Material:
Aluminium/glass

Dimensions:
W/H/D: 31/42/12,5 cm

Accessories/Included:
Conventional ballast [incl.]

Note:
Asymmetrical reflector.

Models:
■ silver-grey
Item no.:
L1229044

Recommended lamp:
70W, 3300K, 5925lm, EEC=A
86kWh/1000h
L1509070

SXL HIT-DE FLOODLIGHT 150W
asymmetrical

EEC= A~A+ 230V~ Ballast EEL=A0 90° 10 IP65

For professional application

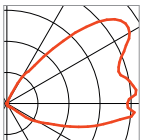

Socket/Lamp [excl.]:
Rx7s / HIT-DE, 150W

Material:
Aluminium/glass

Dimensions:
W/H/D: 31/42/12,5 cm

Accessories/Included:
Conventional ballast [incl.]

Note:
Asymmetrical reflector.

Models:
■ black
□ white
■ silver-grey
Item no.:
L1229000
L1229001
L1229002

Recommended lamp:
150W, 3200K, 12000lm, EEC=A
165kWh/1000h
L1509150

SXL HIT FLOODLIGHT 400W
asymmetrical

EEC= A~A+ 230V~ Ballast EEL=A0 90° 10 IP65

For professional application

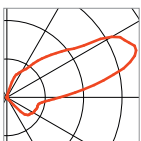

Socket/Lamp [excl.]:
E40 / HIT, 400W

Material:
Aluminium/glass

Dimensions:
W/H/D: 41/54/16,5 cm

Accessories/Included:
Conventional ballast [incl.]

Note:
Asymmetrical reflector.
400W flood light to be used as
up-light only!

Models:
■ silver-grey
Item no.:
L1229012

Recommended lamp:
400W, 4200K, 42000lm, EEC=A+
440kWh/1000h
L1510400



EASYLITE® SPOT G12

For professional application

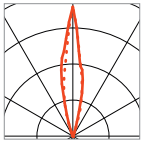

Lamp head can be adjusted and fixed using an allen key and can be tilted by loosening the screw joining in the connection box.

EEC= A-A+ 230V~ Ballast EEL=A3 110° 12 30° 5,4 IP44

Socket/Lamp [excl.]:
G12 / HIT-CE, 70W

Models:
■ stone grey

Item no.:
LI230595

Material:
Aluminium

Dimensions:
Product H: 29 cm
Head Ø/L: 18/25 cm
Base Ø/H: 19/11,5 cm

Accessories/Included:
Conventional ballast [incl.]
Earth spike [excl.]

Recommended lamp:
PHILIPS 70W,
3000K, 6600lm, EEC=A
80kWh/1000h
LI507130



Recommended accessory:
Earth spike, plastic black
Spike L: 25 cm
LI230630



FLAC BEAM® HIT 70W

For professional application

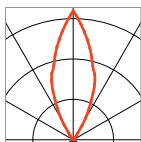

EEC= A-A+ 230V~ Ballast EEL=A3 120° 120° 7-13 20° 5,4 IP65

Socket/Lamp [excl.]:
G12 / HIT-CE, 70W

Models:
■ silver-grey

Item no.:
LI230054

Material:
Aluminium

Dimensions:
Head Ø/H: 20/26 cm
Base L/W: 15/15 cm

Accessories/Included:
Conventional ballast [incl.]

Recommended lamp:
PHILIPS 70W,
3000K, 6600lm, EEC=A
80kWh/1000h
LI507130



FLAC BEAM® LED

Philips DLMi Module

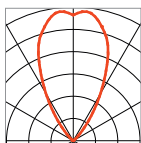

EEC= A-A++ 230V~ LED 1 Module 25000 120° 170° 60° 2,58 IP65

Lamp [incl.]:
PHILIPS DLMi Module, 28W

Models:
■ stone grey
3000K, 2000lm, CRI>80 LI231092

Item no.:
LI231092

Material:
Aluminium

Dimensions:
Head Ø/H: 17/15 cm
Base L/W: 10/10 cm
Connection lead L: 2 m

Accessories/Included:
Mains plug: IP safety plug [incl.]





Vano Wing [LI229394]
Image shows fitting with holders.
Those are not included in the delivery
and need to be ordered separately.

VANO WING PL

EEC=A 230V~ Ballast EEI=B2 +A ↓ +A ↑ +A 95° IP65

- + Asymmetrical reflector
- + For professional application



Socket/Lamp [excl.]:
2G11 / TC-L, 36W

Models:
■ silver-grey

Item no.:
LI229392

Material:
Aluminium/glass

Dimensions:
W/H/D: 50/7,5/15,5 cm

Accessories/Included:
Low-loss ballast [incl.]
Holder [excl.]

Note:
Asymmetrical reflector.

Recommended lamp:
36W, 2700K, 2900lm, EEC=A
40kWh/1000h
LI590144

Recommended accessory:
Holder,
steel, silver-grey, 2 pcs.
Product H: 13,5 cm
Base L/W: 8/5 cm
Adjustment range: 95°
LI229395

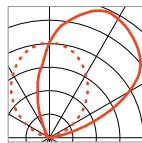

Image shows fitting with holders.
Those are not included in the delivery
and need to be ordered separately.

VANO WING

EEC=A-A+ 230V~ Ballast EEI=A2 +A ↓ +A ↑ +A 105° IP65

- Asymmetrical reflector
- + Electronic ballast
- + High-output lamp
- For professional application



Socket/Lamp [excl.]:
G5 / T16, 54W

Models:
■ silver-grey

Item no.:
LI229394

Material:
Aluminium/glass

Dimensions:
W/H/D: 123,5/7,5/15,5 cm

Accessories/Included:
Electronic ballast [incl.]
Holder [excl.]

Note:
Asymmetrical reflector.

Recommended lamp:
54W, 3000K, 4450lm, EEC=A+
60kWh/1000h
LI548054

Recommended accessory:
Holder,
steel, silver-grey, 2 pcs.
Product H: 13,5 cm
Base L/W: 8/5 cm
Adjustment range: 95°
LI229395

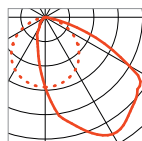

Image shows fitting with holders.
Those are not included in the delivery
and need to be ordered separately.



Vano Display [LI229400]
Image shows fitting with holders.
Those are not included in the delivery
and need to be ordered separately.



VANO TC

EEC= A 230V~ Ballast EEL=B2 ←+A ↓+A ↑+A 7-12 3,5 IP65



Image shows fitting with holders.
Those are not included in the delivery
and need to be ordered separately.

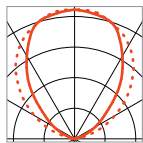

Socket/Lamp [excl.]:
2G11 / TC-L, 36W

Material:
Aluminium/glass

Dimensions:
W/H/D: 52,5/10/11 cm

Accessories/Included:
Low-loss ballast [incl.]
Holder [excl.]

Models:
■ silver-grey

Item no.:
LI229405

Recommended lamp:
36W, 2700K, 2900lm, EEC=A
40kWh/1000h
LI590144

Recommended accessory:
Holder, short,
steel, silver-grey, 2 pcs.
Adjustment range: 95°
Product H: 9 cm
Base L/W: 5/5 cm
LI229402



Recommended accessory:
Holder, short, adjustable
steel, silver-grey, 2 pcs.
Adjustment range: 95°
Product H: 19-27 cm
Base L/W: 6/10 cm
LI229403



Recommended accessory:
Holder, long, adjustable
steel, silver-grey, 1 pce. For wall-mounting Vano Display **3 holders** are required each.
Adjustment range: 95°
Product L: 47-80 cm
Base L/W: 12/10 cm
LI229406



VANO DISPLAY

EEC= A+A+ 230V~ Ballast EEL=A2 ←+A ↓+A ↑+A 7-12 7,9 IP65

⚡ **Electronic ballast**
⚡ **High-efficient lamp**



Image shows fitting with holders.
Those are not included in the delivery
and need to be ordered separately.

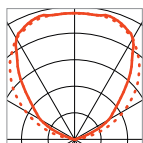

Socket/Lamp [excl.]:
G5 / T16, 2x 35W

Material:
Aluminium/glass

Dimensions:
W/H/D: 156/10/11 cm

Accessories/Included:
Electronic ballast [incl.]
Holder [excl.]

Models:
■ silver-grey

Item no.:
LI229400

Recommended lamp:
35W, 3000K, 3300lm, EEC=A+
38kWh/1000h
LI548035

Recommended accessory:
Holder, short,
steel, silver-grey, 2 pcs.
Adjustment range: 95°
Product H: 9 cm
Base L/W: 5/5 cm
LI229402



Recommended accessory:
Holder, short, adjustable
steel, silver-grey, 2 pcs.
Adjustment range: 95°
Product H: 19-27 cm
Base L/W: 6/10 cm
LI229403



Recommended accessory:
Holder, long, adjustable
steel, silver-grey, 1 pce. For wall-mounting Vano Display **3 holders** are required each.
Adjustment range: 95°
Product L: 47-80 cm
Base L/W: 12/10 cm
LI229406



TORCHES



LANTERNS



ROUND



SQUARE



LONG

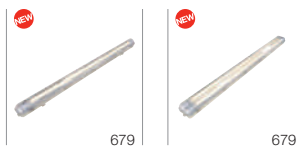

SPOTS





DISPLAY LAMPS

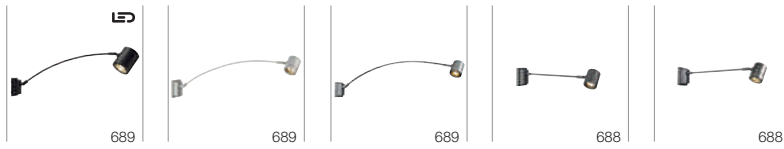

SINGLE BEAM

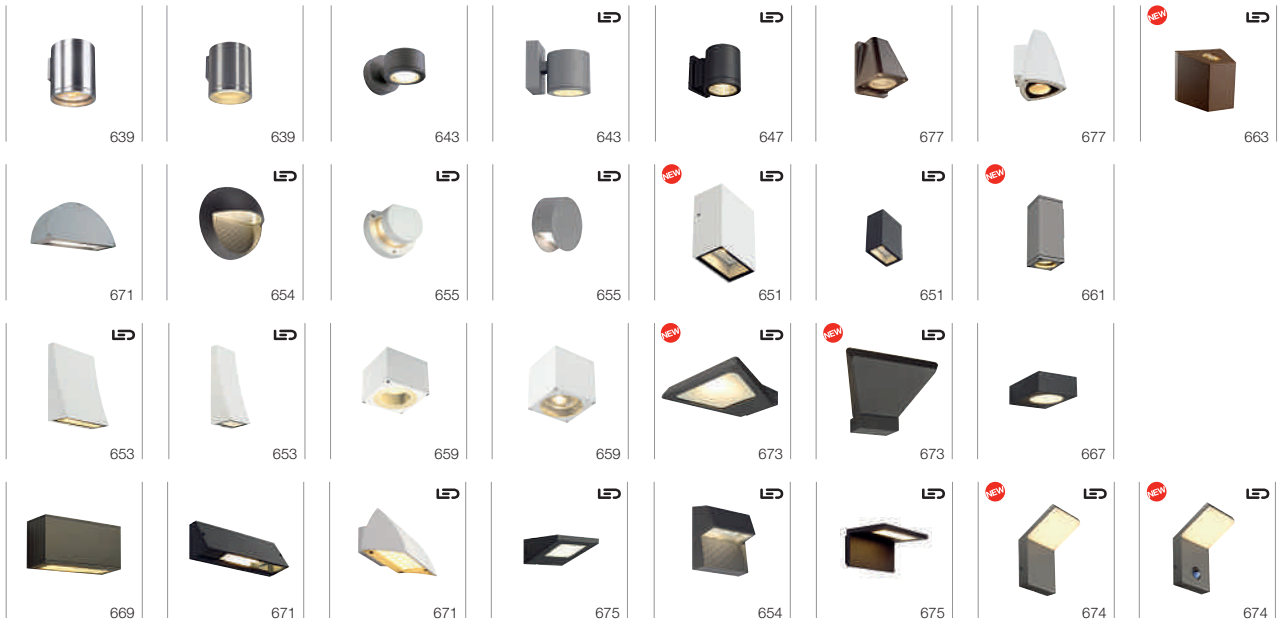

UP-DOWN



TRUST WALL

EEK= A-A++ 230V~ 1,3 IP55



+ Stainless steel



Fitting without grid [not included]

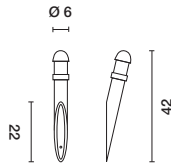

Socket/Lamp [excl.]:
E27 / TC(...)SE, 11W max.
up to max. Ø/L: 4,8/13,9 cm

Lamp options [excl.]:

Material:
Stainless steel 304/polycarbonate

Dimensions:
Distance to wall: 10 cm

Accessories/Included:
Screws [incl.]
Grid [excl.]

Models:
■ stainless steel

Item no.:
L1227942

LED UPGRADE:

LED E27 Tube, 4,7W,
3000K, 380lm, EEC=A+
5kWh/1000h
L1551532



Recommended accessory:

Raster, Stainless steel 304
Ø/H: 8/10 cm
L1227952



BIG NAILS PLUS WALL LIGHT

EEK= A-A++ 230V~ 0,96 IP44



+ Stainless steel

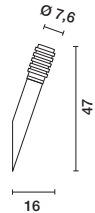
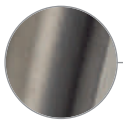
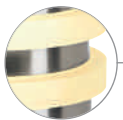

Socket/Lamp [excl.]:
E27 / TC(...)SE, 23W max.
up to max. Ø/L: 4,8/14,8 cm

Lamp options [excl.]:

Material:
Stainless steel 304/acrylic glass

Models:
■ stainless steel

Item no.:
L1231622

LED UPGRADE:

LED E27 Tube, 4,7W,
3000K, 380lm, EEC=A+
5kWh/1000h
L1551532



Recommended accessory:

Connection box IP68, plastic, 3-pole,
Ø/L: 2,7/11,5 cm. For a safe
connection in the body.
L1228730



GRAFIT TORCH

EEK= A-A++ 230V~ 1,06 IP44



+ Frosted lamp shade with smoked glass appearance

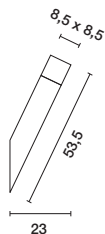

Socket/Lamp [excl.]:
E27 / TC(...)SE, 11W max.
up to max. Ø/L: 6,8/12,2 cm

Lamp options [excl.]:

Material:
Aluminium/plastic

Models:
■ anthracite

Item no.:
L1231195

LED UPGRADE:

SMD LED, 6W,
3000K, 450lm, EEC=A+
6kWh/1000h
L1551553





NAILS WALL LIGHT

EEC= D-A+ 230V~ 0,6 IP44

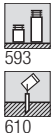

- Stainless steel
- Easy change of design by turning over the glass insert

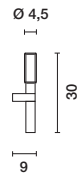

Socket/Lamp [excl.]:
G9 / QT14, 40W max.
up to max. Ø/L: 1,4/ 4,3 cm

Lamp options [excl.]:
Perfectfit

Material:
Stainless steel 304/glass

Accessories/Included:
Glass insert [incl.]

Models:
■ stainless steel **Item no.:**
LI229132

Recommended lamp:
33W ± 40W
2700K, 460lm, EEC=D
33kWh/1000h
LI519451



BIG NAILS WALL LIGHT

EEC= A-A+++ 230V~ 1,2 IP44



- Stainless steel

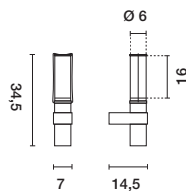

Socket/Lamp [excl.]:
E27 / TC(...)SE, 15W max.
up to max. Ø/L: 4,5/17 cm

Lamp options [excl.]:
LED

Material:
Stainless steel 304/polycarbonate

Models:
■ stainless steel **Item no.:**
LI229182

LED UPGRADE:
LED E27 Tube, 4,7W,
3000K, 380lm, EEC=A+
5kWh/1000h
LI551532







C-POL WALL

EEC= A-A+++ 230V~ IP54



High-gloss reflector

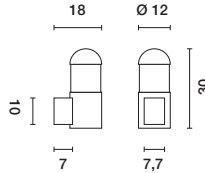

Socket/Lamp [excl.]:
E27 / TC(...)SE, 24W max.
up to max. Ø/L: 5,2/17,3 cm

Lamp options [excl.]:

Material:
Aluminium/polycarbonate

Models:
■ anthracite **Item no.:**
LI231465

Recommended lamp:
23W, 2700K, 1450lm, EEC=A
23kWh/1000h
LI508770



F-POL WALL

EEC= A-A+++ 230V~ IP54



High-gloss reflector

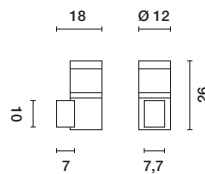

Socket/Lamp [excl.]:
E27 / TC(...)SE, 20W max.
up to max. Ø/L: 5/14 cm

Lamp options [excl.]:

Material:
Aluminium/polycarbonate

Models:
■ anthracite **Item no.:**
LI231585

Recommended lamp:
20W, 2700K, 1200lm, EEC=A
20kWh/1000h
LI508760



GRAFIT WL

EEC= A-A+++ 230V~ IP44

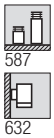

Frosted lamp shade with smoked glass appearance

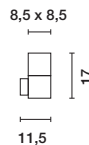

Socket/Lamp [excl.]:
E27 / TC(...)SE, 11W max.
up to max. Ø/L: 6/11,5 cm

Lamp options [excl.]:

Material:
Aluminium/plastic

Dimensions:
Canopy W/H/D: 6,2/6,2/3 cm

Models:
■ anthracite **Item no.:**
LI231205

LED UPGRADE:
PHILIPS Corepro LED E27, 5,5W,
2700K, 470lm, EEC=A+
6kWh/1000h
LI560160



SQUARE WL

EEC= A-A+++ 230V~ IP44

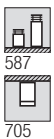

Alu brushed

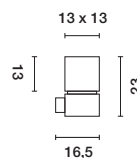

Socket/Lamp [excl.]:
E27 / TC(...)SE, 20W max.
up to max. Ø/H: 6/13 cm

Lamp options [excl.]:

Material:
Aluminium/acrylic glass

Dimensions:
Canopy W/H/D: 7/5,5/3,5 cm

Models:
■ alu brushed/
lacquered **Item no.:**
LI230706

LED UPGRADE:
PHILIPS Corepro LED E27, 5,5W,
2700K, 470lm, EEC=A+
6kWh/1000h
LI560160





[LI232276] | page 586

ROX ACRYLIC SINGLE | ROX ACRYLIC UP-DOWN

EEC= A-A++ 230V~ IP44

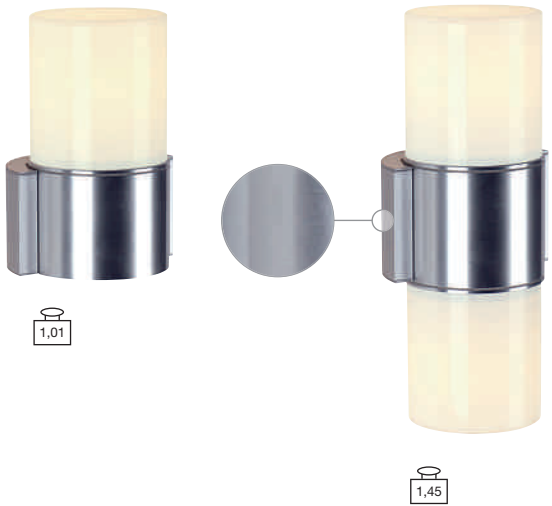

Socket/Lamp [excl.]:
E27 / TC(...SE),
20W max. [LI230736]
2x 20W max. [LI230746]
up to max. Ø/L: 6/17 cm

Lamp options [excl.]:
LED

Material:
Aluminium/acrylic glass

Models:
Rox Acrylic Single
■ alu brushed **LI230736**

Rox Acrylic Up-Down
■ alu brushed **LI230746**

UPGRADE:
PHILIPS Corepro LED E27, 9,5W,
dimmable
2700K, 806lm, EEC=A+
10kWh/1000h
LI560161

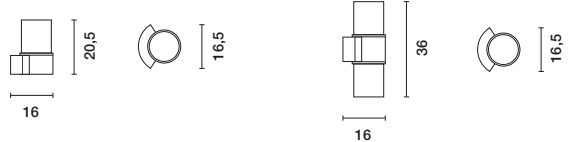



[LI232025] | page 597

GLOO PURE WALL

EEC= A-A++ 230V~ IP44



+ Genuine glass

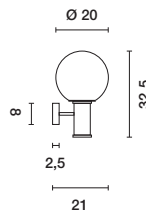

Socket/Lamp [excl.]:
E27 / TC(...)SE, 20W max.
up to max. Ø/L: 4,8/18 cm

Lamp options [excl.]:

Material:
Steel/glass

Models:
 white anthracite

Item no.:
LI232005

LED UPGRADE:
LED E27 Tube, 4,7W,
3000K, 380lm, EEC=A+
5kWh/1000h
LI551532







ROX WALL OUT

EEC= E-A++ 230V- 0,9 IP44

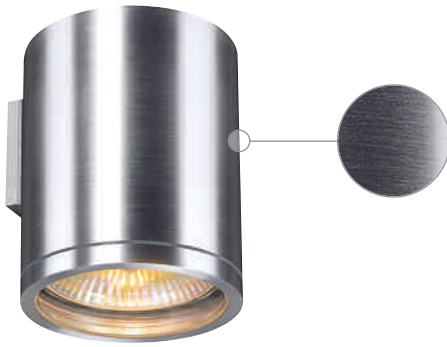

Socket/Lamp [excl.]:
GU10 / QPAR111, 75W max.

Models:
■ alu brushed

Item no.:
LI229766

Lamp options [excl.]:
LED

Material:
Aluminium/glass

Dimensions:
Ø/H/D: 12,5/16/13 cm
Canopy W/H/D: 5,5/7/0,5 cm

LED UPGRADE:
LED ES111, 17,5W, 30°
2700K, 880lm, EEC=A
18kWh/1000h
LI551642



ROX UP-DOWN OUT

EEC= E-A++ 230V- 1,2 IP44



Socket/Lamp [excl.]:
GU10 / QPAR111, 2x 50W max.

Models:
■ alu brushed

Item no.:
LI229776

Lamp options [excl.]:
LED

Material:
Aluminium/glass

Dimensions:
Ø/H/D: 12,5/20,5/13 cm
Canopy W/H/D: 5,5/7/0,5 cm

LED UPGRADE:
LED ES111, 17,5W, 30°
2700K, 880lm, EEC=A
18kWh/1000h
LI551642



ROX WALL GX53 OUT

EEC= B-A++ 230V- 0,9 IP44

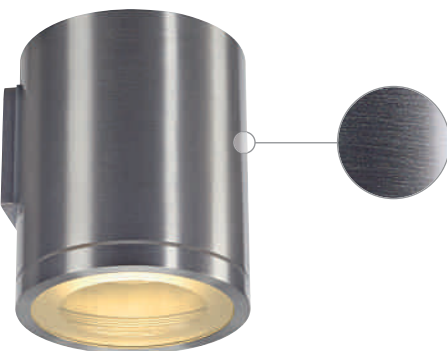

Socket/Lamp [excl.]:
GX53 / TCR-TSE, 11W max.
up to max. Ø/H: 7,5/3,5 cm

Models:
■ alu brushed

Item no.:
LI229746

Lamp options [excl.]:
LED

Material:
Aluminium/glass

Dimensions:
Ø/H/D: 12,5/14,5/13 cm
Canopy W/H/D: 5,5/7/0,5 cm

LED UPGRADE:
SMD LED 7,5W, 25°
3000K, 450lm, EEC=A
8kWh/1000h
LI550082



ROX UP-DOWN GX53 OUT

EEC= B-A++ 230V- 0,9 IP44



Socket/Lamp [excl.]:
GX53 / TCR-TSE, 11W max.
up to max. Ø/H: 7,5/3,5 cm

Models:
■ alu brushed

Item no.:
LI229786

Lamp options [excl.]:
LED

Material:
Aluminium/glass

Dimensions:
Ø/H/D: 12,5/16/13 cm
Canopy W/H/D: 5,5/7/0,5 cm

LED UPGRADE:
SMD LED 7,5W, 25°
3000K, 450lm, EEC=A
8kWh/1000h
LI550082







ASTINA OUT

EEC= B-A++ 230V- 0,8 IP44

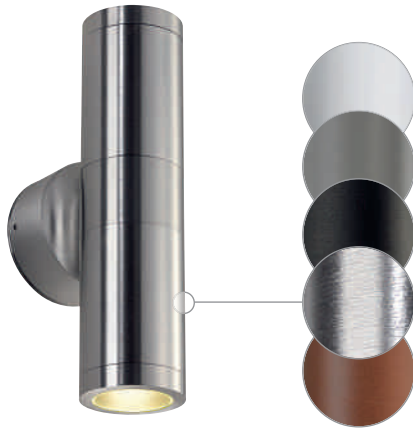

Socket/Lamp [excl.]:
GU10 / TC(...)SE, 2x 11W max.
up to max. length: 9 cm

Lamp options [excl.]:
LED

Material:
Aluminium/glass

Models:
 white
 silver-grey
 anthracite
 rust

Item no.:
 LI228771
 LI228774
 LI228775
 LI228777 **NEW**

alu brushed LI228776

LED UPGRADE:
 LED GU10 4,3W, 40°
 2700K, 245lm, EEC=A+
 5kWh/1000h
 LI551252



ASTINA STEEL GU10

EEC= E-A++ 230V- 1,02 IP44

Stainless steel 304

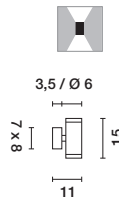

Socket/Lamp [excl.]:
GU10 / QPAR51, 2x 35W max.
up to max. Ø/L: 5,1/5,7 cm

Lamp options [excl.]:
LED

Material:
Stainless steel 304

Models:
 stainless steel

Item no.:
LI233302

LED UPGRADE:
 LED GU10 4,3W, 40°
 2700K, 245lm, EEC=A+
 5kWh/1000h
 LI551252



ASTINA STEEL LED

EEC= A-A++ 100V-277V- 350mA LED 2 Modules 25000 45° 1,38 IP44

Stainless steel 316
Premium LED

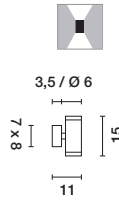

Lamp [incl.]:
LED PowerLED, 2x 3W
Total consumption: 8,7W

Material:
Stainless steel 316

Accessories/Included:
LED driver [incl.]

Models:
3000K, 510lm, CRI 80
 stainless steel

Item no.:
LI233312



ROX LED UP-DOWN

EEC= A-A++ 230V- 700 mA LED 2 pcs. 30000 45° 0,9 IP44

Premium LED

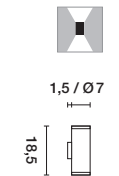
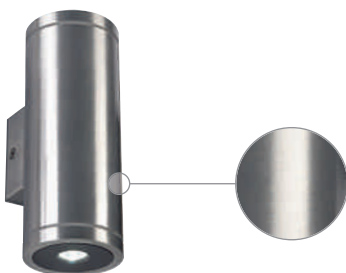

Lamp [incl.]:
LED PowerLED, 2x 3W
Total consumption: 6,8W

Material:
Aluminium/glass

Accessories/Included:
LED driver [incl.]

Models:
3000K, 120lm, CRI>80
 alu brushed/
 lacquered

Item no.:
▼ LI227232







SITRA WALL

EEC= B-A++ 230V- 1 IP44

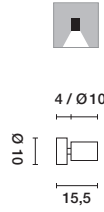
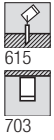

Socket/Lamp [excl.]:
GX53 / Ø TCR-TSE, 9W max.
up to max. Ø/H: 7,5/3,5 cm

Models:
■ stone grey
■ anthracite

Item no.:
LI230354
LI230355

Lamp options [excl.]:
LED

Material:
Aluminium/glass

LED UPGRADE:
LED GX53, 3W, 120°
3000K, 250lm, EEC=A++
3kWh/1000h
LI551372



SITRA WALL UP-DOWN

EEC= B-A++ 230V- 1,4 IP44

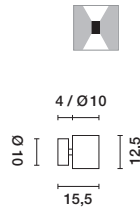
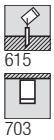

Socket/Lamp [excl.]:
GX53 / Ø TCR-TSE, 2x 9W max.
up to max. Ø/H: 7,5/3,5 cm

Models:
■ stone grey
■ anthracite

Item no.:
LI230364
LI230365

Lamp options [excl.]:
LED

Material:
Aluminium/glass

LED UPGRADE:
LED GX53, 3W, 120°
3000K, 250lm, EEC=A++
3kWh/1000h
LI551372



SITRA 6x 1W LED

EEC= A-A++ 230V- 350 mA (LED) LED 1 Module 30000 45° 1,15 IP44

± Premium LED

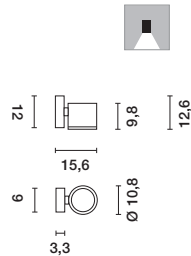

Lamp [incl.]:
LED PowerLED, 6x 1W
Total consumption: 8,9W

Models:
3000K, 580lm, CRI>80
■ silver-grey

Item no.:
LI230332

Material:
Aluminium/glass

Accessories/Included:
LED driver [incl.]

LED INSIDE





MYRALED WALL



- + Premium LED
- + Lamp head individually adjustable



Lamp [incl.]:
 COB LED, 5W
 Total consumption: 6,8W

Material:
 Aluminium/glass

Accessories/Included:
 LED driver [incl.]

Models:
 3000K, 350lm, CRI 81
 silver-grey
 anthracite

Item no.:
 LI233204
 LI233205



Recommended accessory:
 Frame for surface mounting, aluminium
 Product W/H/D: 9,2/11,6/1,8 cm
 Weight: 1,08 kg
 LI233214
 LI233215



NEW MYRA WALL
 Wall light, 1 Spot



- + Lamp head individually adjustable

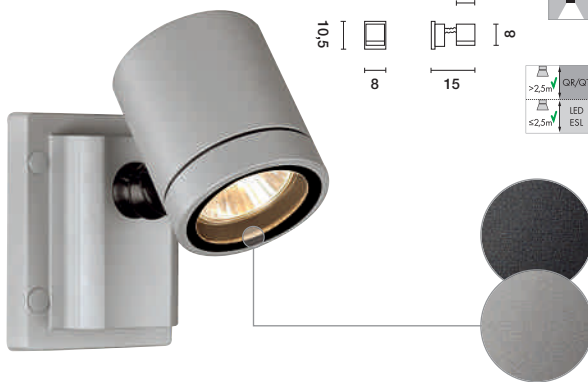

Socket/Lamp [excl.]:
 GU10 / QPAR51, 50W max.
 up to max. Ø/H: 5/5,7 cm

Lamp options [excl.]:

Material:
 Aluminium/glass

Recommended accessory:
 Frame for surface mounting, aluminium
 Product W/H/D: 9,2/11,6/1,8 cm
 Weight: 1,08 kg
 LI233214
 LI233215

Models:
 silver-grey
 anthracite

Item no.:
 LI233104
 LI233105

LED UPGRADE:
PHILIPS Corepro LED Spot 3,5W, 36°
 3000K, 245lm, EEC=A+
 4kWh/1000h
 LI560084



NEW MYRA WALL
 Wall light, 2 Spots



- + Lamp heads individually adjustable



Socket/Lamp [excl.]:
 GU10 / QPAR51, 2x 50W max.
 up to max. Ø/L: 5/5,7 cm

Lamp options [excl.]:

Material:
 Aluminium/glass

Dimensions:
 W/H/D: 14,6/9,8/14,4 cm
 Head Ø/L: 6,8/7,8 cm
 Canopy W/H/D: 11,8/8/3,5 cm

Models:
 silver-grey
 anthracite

Item no.:
 LI233094
 LI233095

LED UPGRADE:
PHILIPS Corepro LED Spot 3,5W, 36°
 3000K, 245lm, EEC=A+
 4kWh/1000h
 LI560084



NEW MYRA
 Wall light, Up-Down



- + Lamp head individually adjustable

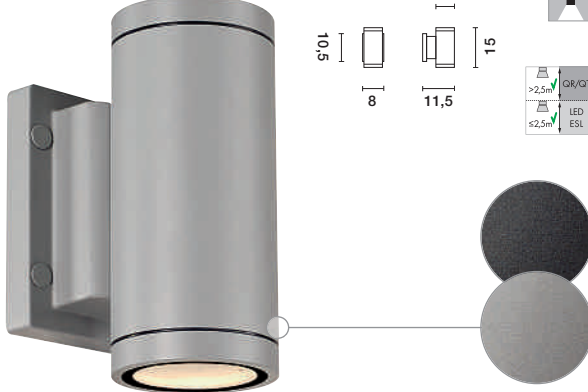

Socket/Lamp [excl.]:
 GU10 / QPAR51, 2x 35W max.
 up to max. Ø/H: 5/5,7 cm

Lamp options [excl.]:

Material:
 Aluminium/glass

Recommended accessory:
 Frame for surface mounting, aluminium
 Product W/H/D: 9,2/11,6/1,8 cm
 Weight: 1,08 kg
 LI233214
 LI233215

Models:
 silver-grey
 anthracite

Item no.:
 LI233114
 LI233115

LED UPGRADE:
PHILIPS Corepro LED Spot 3,5W, 36°
 3000K, 245lm, EEC=A+
 4kWh/1000h
 LI560084







ENOLA_C OUT WL

† Premium LED



Lamp [incl.]:
 COB LED, 9W
 Total consumption: 11,2W

Material:
 Aluminium/glass

Dimensions:
 Ø/H/D: 10/11,8/14,5 cm
 Canopy W/H: 8,2/10,5 cm

Accessories/Included:
 LED driver [incl.]

Models:
 3000K, 750lm, CRI>80
 white
 anthracite

Item no.:
 LI228511
 LI228515



Recommended accessory:
 Frame for surface mounting, aluminium
 Product W/H/D: 9,2/11,6/1,8 cm
 Weight: 1,08 kg
 LI233214
 LI233215



ENOLA_C OUT UP-DOWN

† Premium LED



Lamp [incl.]:
 COB LED, 2x 9W
 Total consumption: 22,3W

Material:
 Aluminium/glass

Dimensions:
 Ø/H/D: 10/23,2/14,5 cm
 Canopy W/H: 8,2/10,5 cm

Accessories/Included:
 LED driver [incl.]

Models:
 3000K, 1500lm, CRI>80
 white
 anthracite

Item no.:
 LI228521
 LI228525



Recommended accessory:
 Frame for surface mounting, aluminium
 Product W/H/D: 9,2/11,6/1,8 cm
 Weight: 1,08 kg
 LI233214
 LI233215



ROX PRO G8,5

† Quick installation system
 † For professional application: lamp
 with luminous flux up to 4000lm

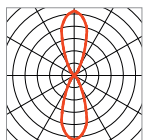

Socket/Lamp [excl.]:
 G8,5 / HIT-TC, 2x 35W

Material:
 Aluminium/glass

Dimensions:
 Ø/H/D: 14/40,5/20 cm
 Canopy W/H/D: 5/12,5/5,5 cm

Accessories/Included:
 Conventional ballast [incl.]

Models:
 white
 anthracite

Item no.:
 LI227881
 LI227885

Recommended lamp:
PHILIPS 35W,
 3000K, 3000lm, EEC=A
 41kWh/1000h
 LI507035







DELWA CURVE

EEC= A-A++ 100V-240V- 350mA (LED) LED 8 pcs. 25000 25° IP44



Lamp [incl.]:
 LED PowerLED, 2x 4x 1W
 Total consumption: 10,5W

Models:
 4000K, 620lm, CRI 80
 ■ silver-grey

Item no.:
 LI227290

Material:
 Aluminium/glass

Accessories/Included:
 LED driver [incl.]

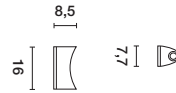

TENDA LED

EEC= A-A++ 100V-240V- 350mA (LED) LED 2 pcs. 60000 Beam 4° Flood 120° IP44

Special light effect

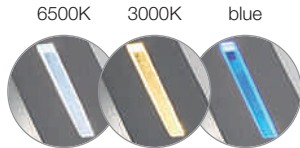

6500K 3000K blue



Lamp [incl.]:
 LED COB LED
 2x 3,3W
 2x 340lm
 Total consumption: 8W

Models:
 ■ alu brushed
 Flood & Beam
 6500K, CRI>80

Item no.:
 LI229641

Material:
 Aluminium/glass

Flood & Beam
 3000K, CRI>80

Item no.:
 LI229642

Accessories/Included:
 LED driver [incl.]

Flood 6500K, CRI>80 /
 Beam blue

Item no.:
 LI229647

■ anthracite
 Flood & Beam
 3000K, CRI>80

Item no.:
 LI229652

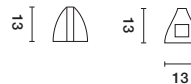

UFO BEAM

EEC= D-A+ 230V- IP44



Socket/Lamp [excl.]:
 G9 / QT14, 42W max.

Models:
 ■ silver-grey
 Polycarbonate white
 Polycarbonate blue

Item no.:
 LI151751
 LI151757

Material:
 Aluminium
 Lenses: glass and polycarbonate

Recommended lamp:
 33W ± 40W
 2700K, 460lm, EEC=D
 33kWh/1000h
 LI1519451

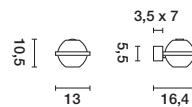



+ Premium LED **+** **QUAD 2 XL**

+ Premium LED

NEW



Lamp [incl.]:
LED COB LED
 Total consumption: 8,6W



Material:
 Aluminium/glass



Accessories/Included:
 LED driver [incl.]

Models:
 3000K, 580lm, CRI 80
 white **LI232441**

3000K, 520lm, CRI 80
 anthracite **LI232445**



+ Premium LED **+** **QUAD 2**

+ Premium LED



Lamp [incl.]:
LED PowerLED, 2x 3W
 Total consumption: 6,8W



Material:
 Aluminium/glass



Accessories/Included:
 LED driver [incl.]

Models:
 3000K, 175lm, CRI 80
 white **LI232471**

3000K, 140lm, CRI 80
 anthracite **LI232475**





QUAD 1

± Premium LED

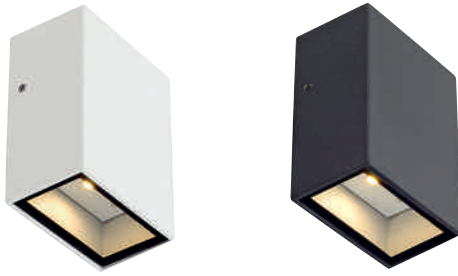

Lamp [incl.]:
 PowerLED, 3W
 Total consumption: 4,6W

Material:
 Aluminium/glass

Accessories/Included:
 LED driver [incl.]

Models:
 3000K, 100lm, CRI 80
 white **LI232461**
 3000K, 80lm, CRI 80
 anthracite **LI232465**

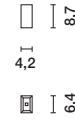

QUAD 1 XL

± Premium LED



Lamp [incl.]:
 LED
 Total consumption: 4,5W

Material:
 Aluminium/glass

Dimensions:
 W/H/D: 8,4/11/5,4 cm

Accessories/Included:
 LED driver [incl.]

Models:
 3000K, 290lm, CRI 80
 white **LI232431**
 3000K, 260lm, CRI 80
 anthracite **LI232435**

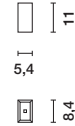

BIG QUAD

± Premium LED



Lamp [incl.]:
 PowerLED, 2x 3x1W
 Total consumption: 8,8W

Material:
 Aluminium/glass

Accessories/Included:
 LED driver [incl.]

Models:
 3000K, 480lm, CRI 80
 white **LI232451**
 anthracite **LI232455**

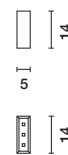



LOGS WALL



- + Indirect light emission
- + Premium LED



Lamp [incl.]:
 COB LED, 6W
 Total consumption: 8W

Material:
 Aluminium

Accessories/Included:
 LED driver [incl.]

Models:
 3000K, 450lm, CRI>80

<input type="checkbox"/> white	LI232101
<input type="checkbox"/> silver-grey	LI232104
<input type="checkbox"/> anthracite	LI232105

Item no.:

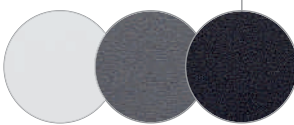
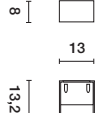



DELWA WIDE

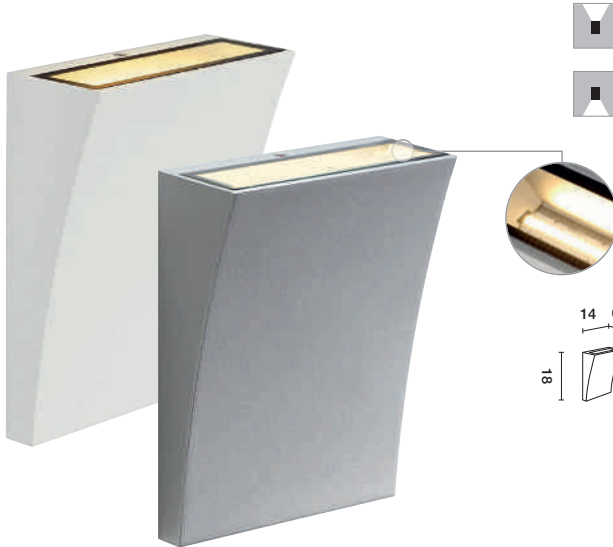

Lamp [incl.]:
 SMD LED, 6,5W
 Total consumption: 8,8W

Material:
 Aluminium/glass

Accessories/Included:
 LED driver [incl.]

Models:
 3000K, 620lm, CRI 80
 white
 silver-grey

Item no.:
 LI230791
 LI230794



DELWA



Lamp [incl.]:
 PowerLED, 4,5W
 Total consumption: 6,3W

Material:
 Aluminium/glass

Models:
 3000K, 245lm, CRI 80
 white
 silver-grey

Item no.:
 LI231902
 LI231912





LED DOWNUNDER ROUND

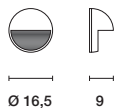
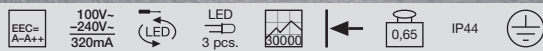

Lamp [incl.]:
 LED PowerLED, 3x 1W
 Total consumption: 5W

Material:
 Aluminium/acrylic glass

Accessories/Included:
 LED driver [incl.]

Note:
 Safety class IP44 only when installed with downwards-directed light emission.

Models:
 3000K, 100lm, CRI 80
 ■ anthracite

Item no.:
LI230862



LED DOWNUNDER SQUARE

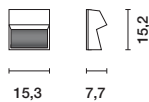
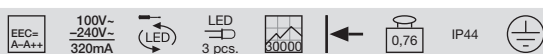

Lamp [incl.]:
 LED PowerLED, 3x 1W
 Total consumption: 5W

Material:
 Aluminium/acrylic glass

Accessories/Included:
 LED driver [incl.]

Note:
 Safety class IP44 only when installed with downwards-directed light emission.

Models:
 3000K, 100lm, CRI 80
 ■ anthracite

Item no.:
LI230872





KYKLOP WALL



555



Lamp [incl.]:
LED PowerLED, 3x 1W
 Total consumption: 5,3W

Material:
 Aluminium/glass

Dimensions:
 W/H/D: 13,5/8,3/10,6 cm

Accessories/Included:
 LED driver [incl.]

Models: Glass frosted
 3000K, 130lm, CRI 80
 white **LI231481**
 anthracite **LI231485**

Item no.:



PEMA LED WALL LIGHT



Premium LED



Lamp [incl.]:
LED PowerLED
 Total consumption: 4,2W

Material:
 Aluminium/glass

Dimensions:
 Ø/D: 9/4,2 cm

Note:
 Safety class IP44 only when installed with downwards-directed light emission.

Models: 3000K, CRI 80
 white 120lm **LI231010**
 anthracite 110lm **LI231015**
 silver-grey 120lm **LI231012**





WL 172 GX53

EEC= B-A++ 230V~ 0,51 IP44

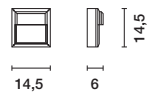

Socket/Lamp [excl.]:
GX53 / Ø TCR-TSE, 11W max.
up to max. Ø/H: 7,5/2,7 cm

Models:
■ silver-grey
■ anthracite

Item no.:
LI229904
LI229905

Lamp options [excl.]:
LED

Material:
Aluminium/polycarbonate

Note:
Safety class IP44 only when installed with downwards-directed light emission.

LED UPGRADE:
LED GX53, 3W, 120°
3000K, 250lm, EEC=A++
3kWh/1000h
LI551372



QUADRASYL 44D

EEC= B-A++ 230V~ 0,45 IP44

↕ Cover: stainless steel
595
700



Socket/Lamp [excl.]:
GX53 / Ø TCR-TSE, 9W max.
up to max. Ø/H: 7,5/2,7 cm

Models:
Cover stainless steel
■ silver-grey

Item no.:
LI111482

Lamp options [excl.]:
LED

Material:
Aluminium
Cover stainless steel 304

Dimensions:
W/H/D: 11/11/4,5 cm

LED UPGRADE:
LED GX53, 3W, 120°
3000K, 250lm, EEC=A++
3kWh/1000h
LI551372





DACU UP-DOWN LED BEAM

Premium LED

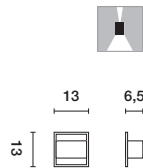

Lamp [incl.]:
 LED PowerLED, 2x 1W
 Total consumption: 3,8W

Models:
 2700K, 73lm, CRI>80
 ■ silver-grey

Item no.:
 LI227252

Material:
 Aluminium

Accessories/Included:
 LED driver [incl.]



DACU UP-DOWN LED

Premium LED

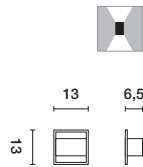

Lamp [incl.]:
 LED PowerLED, 2x 1W
 Total consumption: 3,8W

Models:
 2700K, 110lm, CRI>80
 ■ silver-grey

Item no.:
 LI227262

Material:
 Aluminium

Accessories/Included:
 LED driver [incl.]



DACU UP-DOWN

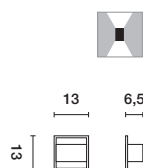

Socket/Lamp [excl.]:
 G9 / QT14, 40W max.
 up to max. Ø/L: 1,4/4,3 cm

Models:
 ■ silver-grey

Item no.:
 LI227132

Lamp options [excl.]:
 LED Perfectfit

Material:
 Aluminium

Recommended lamp:
 33W ± 40W
 2700K, 460lm, EEC=D
 33kWh/1000h
 LI519451







BIG THEO WALL OUT GX53



230V~



IP44

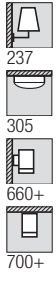

13,5
13
10,2

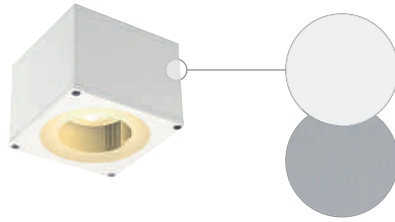

Socket/Lamp [excl.]:
GX53 / TCR-TSE, 11 max.
up to max. Ø/L: 7,5/4 cm

Lamp options [excl.]:
LED

Material:
Aluminium/glass

Models:
Glass partially frosted
□ white
■ silver-grey

Item no.:
▼ LI229991
▼ LI229994

LED UPGRADE:
SMD LED 7,5W, 25°
3000K, 450lm, EEC=A
8kWh/1000h
LI550082



BIG THEO UP-DOWN OUT GX53



230V~



IP44

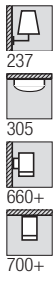

13,5
13
16

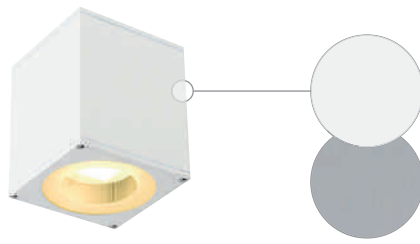

Socket/Lamp [excl.]:
GX53 / TCR-TSE, 2x 11 max.
up to max. Ø/L: 7,5/3,5 cm

Lamp options [excl.]:
LED

Material:
Aluminium/glass

Models:
Glass partially frosted
□ white
■ silver-grey

Item no.:
▼ LI229541
▼ LI229544

LED UPGRADE:
SMD LED 7,5W, 25°
3000K, 450lm, EEC=A
8kWh/1000h
LI550082



BIG THEO WALL OUT



230V~



IP44

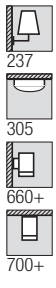

13,5
13
13,5

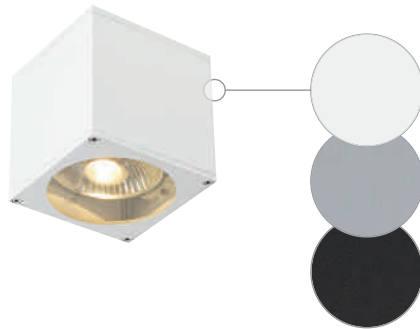

Socket/Lamp [excl.]:
GU10 / QPAR111, 75W max.

Lamp options [excl.]:
LED

Material:
Aluminium/glass

Models:
□ white
■ silver-grey
■ anthracite

Item no.:
LI229561
LI229564
LI229565 ^{SEN}

LED UPGRADE:
LED ES111, 17,5W, 30°
dimming
2700K, 880lm, EEC=A
18kWh/1000h
LI551642



BIG THEO UP-DOWN OUT



230V~



IP44

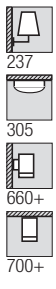

13,5
13
27,5

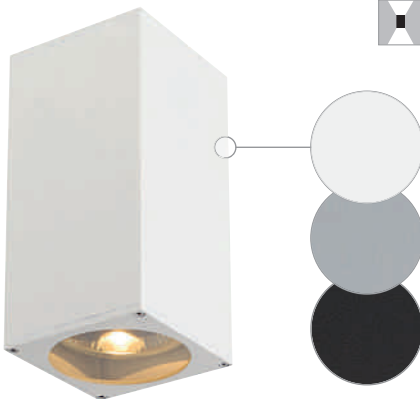

Socket/Lamp [excl.]:
GU10 / QPAR111, 2x 75W max.

Lamp options [excl.]:
LED

Material:
Aluminium/glass

Models:
□ white
■ silver-grey

Item no.:
LI229571
LI229574

■ anthracite **LI229575** ^{SEN}

LED UPGRADE:
LED ES111, 17,5W, 30°
dimming
2700K, 880lm, EEC=A
18kWh/1000h
LI551642



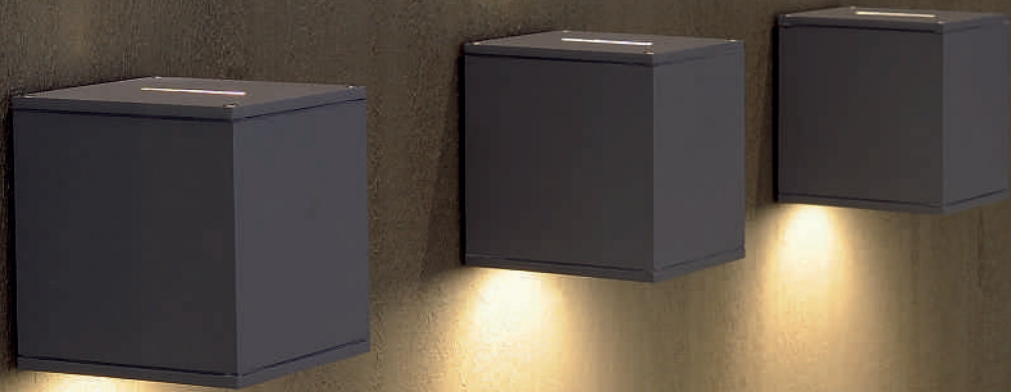

BIG THEO BEAM

EEC= D-A+ 230V~ 0,82 IP44

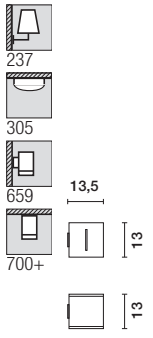

Socket/Lamp [excl.]:
G9 / QT14, 60W max.

Lamp options [excl.]:
Perfectfit

Material:
Aluminium/glass



Models:
Glass frosted
□ white
■ silver-grey

Item no.:
LI229601
LI229604

Recommended lamp:
48W ≈ 60W
2800K, 740lm, EEC=D
48kWh/1000h
LI519452





THEO UP-DOWN OUT

EEC= E-A++ 230V~ 0,79 IP44

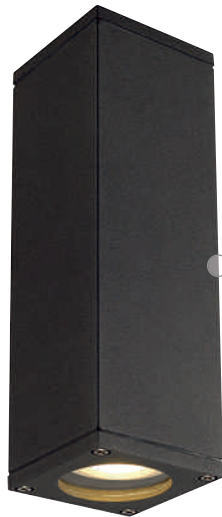
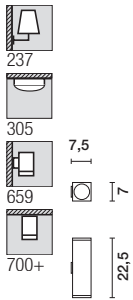

Socket/Lamp [excl.]:
GU10 / QPAR51, 2x 35W max.

Lamp options [excl.]:
LED

Material:
Aluminium/glass

Models:
 white
 silver-grey
 anthracite

Item no.:
 LI229531
 LI229532
 LI229535

alu brushed **LI229536**

LED UPGRADE:

LED GU10 4,3W, 40°
 2700K, 245lm, EEC=A+
 5kWh/1000h
LI551252 | 14,90 €



THEO WALL OUT

EEC= E-A++ 230V~ 0,66 IP44

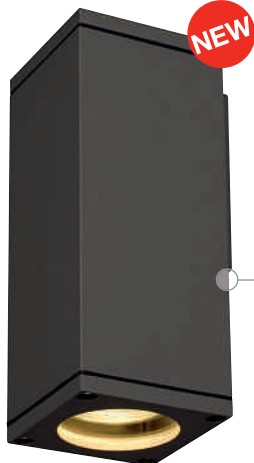
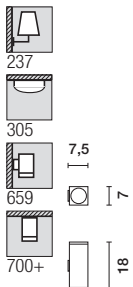

Socket/Lamp [excl.]:
GU10 / QPAR51, 35W max.

Lamp options [excl.]:
LED

Material:
Aluminium/glass

Models:
 white
 silver-grey
 anthracite

Item no.:
 LI229521
 LI229524
 LI229525

LED UPGRADE:

LED GU10 4,3W, 40°
 2700K, 245lm, EEC=A+
 5kWh/1000h
LI551252







+ **OUT-BEAM R7s**

+ Architectural/accentual lighting



EEC= D-C
230V~
Beam 2°
Flood 80°
2,2
IP44



Socket/Lamp [excl.]:
R7s 78mm / QT-DE12, 150W max.

Models:
■ silver-grey

Item no.:
LI227020

Material:
Aluminium/glass

Dimensions:
W¹/W²/H/D: 8/15/15/15,5 cm

Recommended lamp:

PHILIPS Plusline ES
80W ± 100W
2900K, 1415lm, EEC=D
80kWh/1000h
LI519231



+ **+** **OUT-BEAM G8,5**

+ Architectural/accentual lighting
+ For professional application

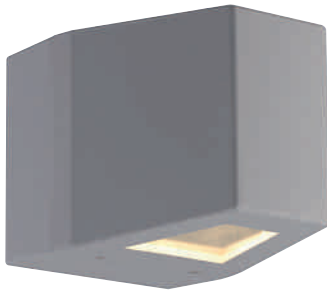

EEC= A++
230V~
Ballast EE=A3
Beam 2°
Flood 80°
3,7
IP44



Socket/Lamp [excl.]:
G8,5 / HIT-TC, 35W

Models:
■ silver-grey

Item no.:
LI227015

Material:
Aluminium/glass

Dimensions:
W¹/W²/H/D: 8/15/15/20,5 cm

Accessories/Included:
Conventional ballast [incl.]

Recommended lamp:

PHILIPS 35W,
3000K, 3000lm, EEC=A
41kWh/1000h
LI507035



+ **+** **OUT-BEAM LED**
Wall light, beam

+ Architectural/accentual lighting
+ Premium LED



Lamp [incl.]:
Beam: **LED** PowerLED
Flood: **LED** COB LED
Total consumption: 18W

Material:
Aluminium/glass

Dimensions:
W/H/D: 15/15/15,8 cm

Accessories/Included:
LED driver [incl.]

Models:
3000K, CRI 80
Beam 500lm
Flood 900lm
■ silver-grey
■ anthracite
■ rust

Item no.:
LI229664
LI229665
LI229667



+ **+** **OUT-BEAM LED**
Wall light, single

+ Architectural/accentual lighting
+ Premium LED



Lamp [incl.]:
LED PowerLED
Total consumption: 8,3W

Material:
Aluminium/glass

Dimensions:
W/H/D: 15/15/15,8 cm

Accessories/Included:
LED driver [incl.]

Models:
3000K, 500lm, CRI 80
■ silver-grey
■ anthracite
■ rust

Item no.:
LI229684
LI229685
LI229687



EEC= A++
120V~ -277V~ 500mA
LED 4 pcs.
LED 1 pcs.
25000
Beam 2°
Flood 80°
1,42
IP44



SQUARE TURN G9

+ Rotatable lamp head

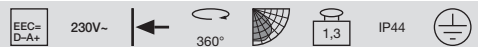

Socket/Lamp [excl.]:
G9 / QT14, 42W max.
up to max. Ø/L: 3,5/8 cm

Lamp options [excl.]:
Perfectfit

Material:
Aluminium/glass

Models:
■ silver-grey

Item no.:
L1230674

Recommended lamp:
33W ≈ 40W
2700K, 460lm, EEC=D
33kWh/1000h
LI519451





SLOTS WALL

EEC= A-A++ 220V- -240V- Module 1 COB LED 2500K ta 40° 0,85 IP44



- + Indirect illumination
- + Premium LED



NEW

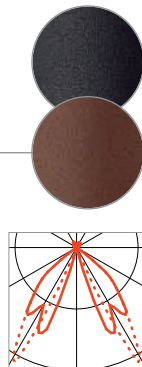

Lamp [incl.]:
 LED COB LED, 6,3W
 Total consumption: 6,3W

Material:
 Aluminium/glass

Dimensions:
 W/H/D: 9,3/21/11,3 cm

Models:
 3000K, 340lm, CRI>80
 ■ anthracite
 ■ rust

Item no.:
 LI231805
 LI231807



The LED module is integrated in the head piece of the wall light and radiates downwards so that a glare is reduced effectively.

OUT-BEAM G9

EEC= D-A+ 230V- 1,15 IP44



Socket/Lamp [excl.]:
 G9 / QT14, 60W max.

Lamp options [excl.]:
 Perfectfit

Material:
 Aluminium/glass

Dimensions:
 W/H/D: 8/8/15,3 cm

Models:
 ■ silver-grey
 ■ anthracite

Item no.:
 LI227064
 LI227065

Recommended lamp:
 33W ± 40W
 2700K, 460lm, EEC=D
 33kWh/1000h
 LI519451







SITRA CUBE

EEC= B-A++ 230V- 1,14 IP44



Socket/Lamp [excl.]:
GX53 / TCR-TSE, 2x 9W max.
up to max. Ø/H: 7,5/2,7 cm

Models:
 white
 anthracite

Item no.:
LI232531
LI232535



Lamp options [excl.]:
LED

rust

LI232537



Material:
Aluminium/glass

LED UPGRADE:
LED GX53, 3W, 120°
3000K, 250lm, EEC=A++
3kWh/1000h
LI551372



QUADRASYL WL 15

EEC= B-A++ 230V- 0,86 IP44

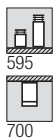

Socket/Lamp [excl.]:
GX53 / TCR-TSE, 11W max.
up to max. Ø/H: 7,5/2,7 cm

Models:
 silver-grey
 anthracite

Item no.:
LI232284
LI232285

Lamp options [excl.]:
LED

Material:
Aluminium/glass

Dimensions:
W/H/D: 12/5,5/15 cm

LED UPGRADE:
LED GX53, 3W, 120°
3000K, 250lm, EEC=A++
3kWh/1000h
LI551372







+ BOX-L E27

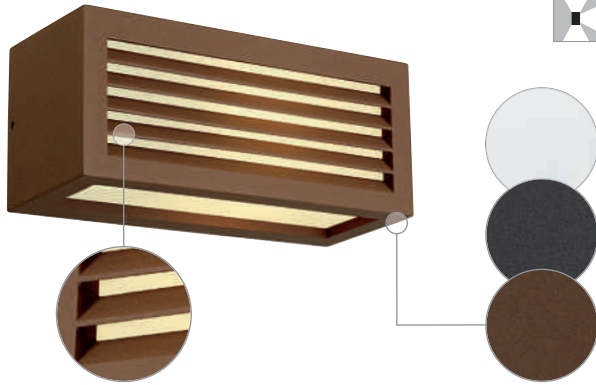

Socket/Lamp [excl.]:
E27 / TC(...)SE, 18W max.
up to max. length: 17,5 cm

Lamp options [excl.]:

Material:
Aluminium/acrylic

Dimensions:
W/H/D: 25/11/11 cm

Models:
Glass frosted
 white
 anthracite
 rust

Item no.:
LI232491
LI232495
LI232497

LED UPGRADE:

PHILIPS Corepro LED E27, 9,5W,
dimmable
2700K, 806lm, EEC=A+
10kWh/1000h
LI560161



+ BOX R7s

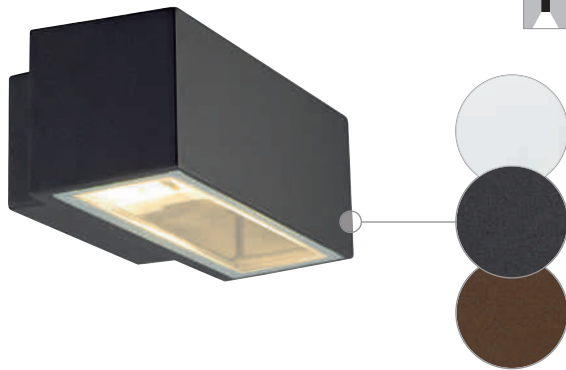

Socket/Lamp [excl.]:
R7s 78mm / QT-DE12, 80W max.

Material:
Aluminium/glass

Dimensions:
W/H/D: 22/9/12 cm

Models:
 white
 anthracite
 rust

Item no.:
LI232481
LI232485
LI232487

Recommended lamp:
PHILIPS Plusline ES
80W ± 100W
2900K, 1415lm, EEC=D
80kWh/1000h
LI519231



+ THEOS 101 E27

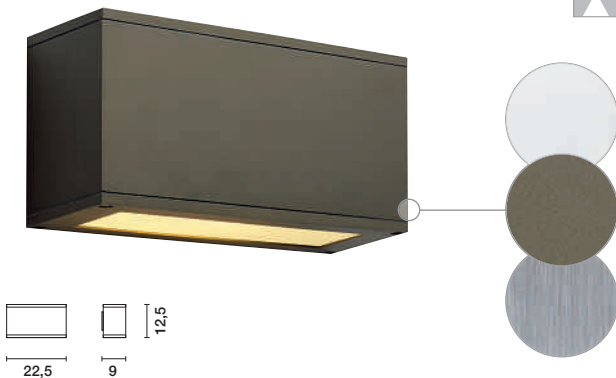

Socket/Lamp [excl.]:
E27 / TC(...)SE, 24W max.
up to max. length: 13 cm

Lamp options [excl.]:

Material:
Aluminium/glass

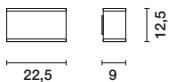

Models:
Glass frosted
 white
 bronze

Item no.:
LI229611
LI229618

alu brushed LI229616

LED UPGRADE:

PHILIPS Corepro LED E27, 5,5W,
2700K, 470lm, EEC=A+
6kWh/1000h
LI560160



+ THEOS 102 E27

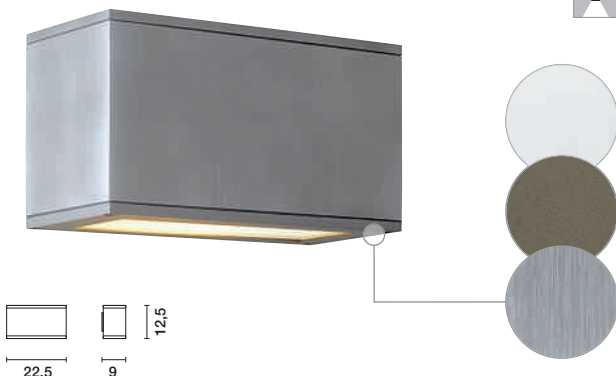

Socket/Lamp [excl.]:
E27 / TC(...)SE, 24W max.
up to max. length: 13 cm

Lamp options [excl.]:

Material:
Aluminium/glass

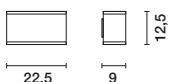

Models:
Glass frosted
 white
 bronze

Item no.:
LI229621
LI229628

alu brushed LI229626

LED UPGRADE:

PHILIPS Corepro LED E27, 5,5W,
2700K, 470lm, EEC=A+
6kWh/1000h
LI560160







PEMA®

+ For professional application



Socket/Lamp [excl.]:
G24d-2 / TC-D, 18W

Material:
Aluminium/glass

Dimensions:
W/H/D: 26/13/9 cm

Accessories/Included:
Low-loss ballast [incl.]

Note:
Safety class IP44 only when installed with downwards-directed light emission.

Models:
■ black
■ silver-grey

Item no.:
LI229890
LI229894

Recommended lamp:
18W, 2700K, 1200lm, EEC=B
22kWh/1000h
LI508218



PEMA® SQUARE



Socket/Lamp [excl.]:
E27 / TC(...),SE, 15W max.
up to max. Ø/L: 4,5/21 cm

Lamp options [excl.]:
LED

Material:
Aluminium/glass

Dimensions:
W/H/D: 28/10/9 cm

Note:
Safety class IP44 only when installed with downwards-directed light emission.

Models:
■ black
□ white
■ silver-grey

Item no.:
LI230030
LI230031
LI230034

Recommended lamp:
15W, 2700K, 800lm, EEC=A
15kWh/1000h
LI508415



NOVA WALL OUT



Socket/Lamp [excl.]:
R7s 78mm / QT-DE12,
100W max.

Material:
Aluminium/glass

Dimensions:
W/H/D: 18/9/9,5 cm

Note:
Safety class IP44 only when installed with downwards-directed light emission.

Models:
■ silver-grey

Item no.:
LI227032

Recommended lamp:
PHILIPS Plusline ES
80W ± 100W
2900K, 1415lm, EEC=D
80kWh/1000h
LI519231



NOVA LED



Lamp [incl.]:
PHILIPS
SMD LED
Total consumption: 7,9W

Material:
Aluminium/glass

Dimensions:
W/H/D: 18/8,5/10 cm

Accessories/Included:
LED driver [incl.]

Note:
Safety class IP44 only when installed with downwards-directed light emission.

Models:
3000K, 360lm, CRI 80
■ black
□ white
■ silver-grey

Item no.:
LI227050
LI227051
LI227054



EEC=B 230V~ Ballast EEL=B2 150° IP44 1,78

EEC=A-A++ 230V~ IP44 1,05

EEC=D-C 230V~ IP44 0,6

EEC=A-A++ 100V~ -240V~ 500mA (LED) LED 21 pcs. 20000 IP44 0,71



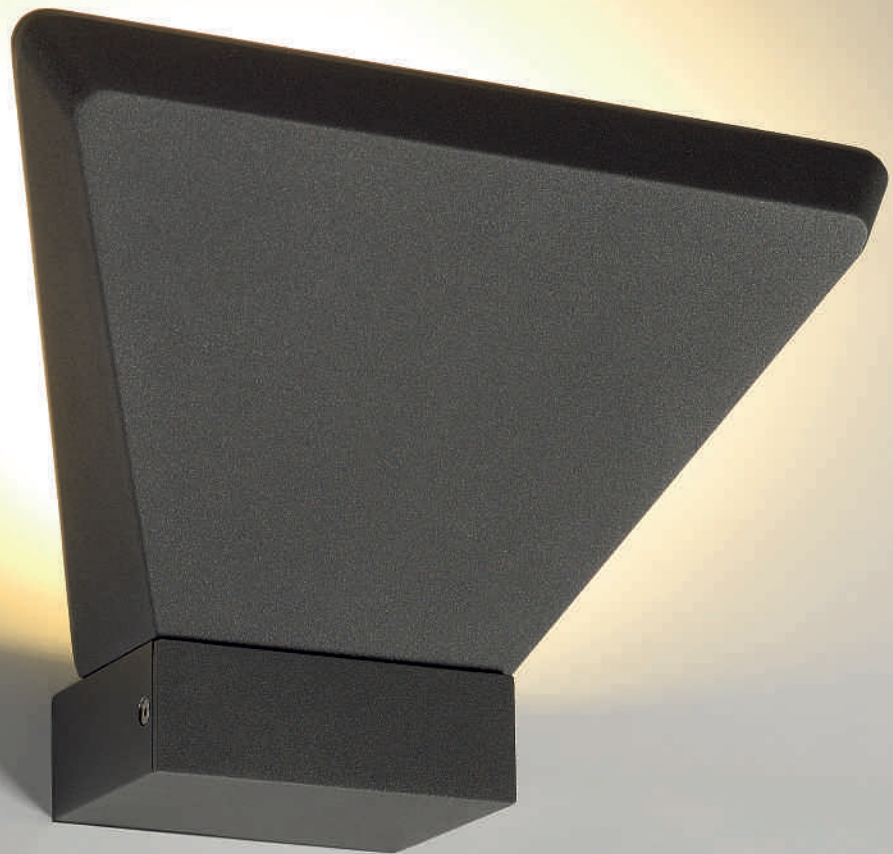

TRAPECCO WALL DOWN



Light effect directed downwards

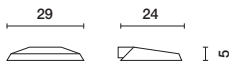

Lamp [incl.]:
 SMD LED
 Total consumption: 10W

Material:
 Aluminium

Dimensions:
 W/H/D: 29/5/24 cm

Models:
 3000K, 850lm, CRI 80
 ■ anthracite

Item no.:
 LI231745



TRAPECCO WALL UP



Light effect directed upwards

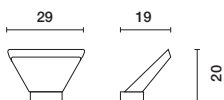

Lamp [incl.]:
 SMD LED
 Total consumption: 10W

Material:
 Aluminium

Dimensions:
 W/H/D: 29/20/19 cm
 Canopy W/H/D: 12/4/8,7 cm

Models:
 3000K, 850lm, CRI 80
 ■ anthracite

Item no.:
 LI231755



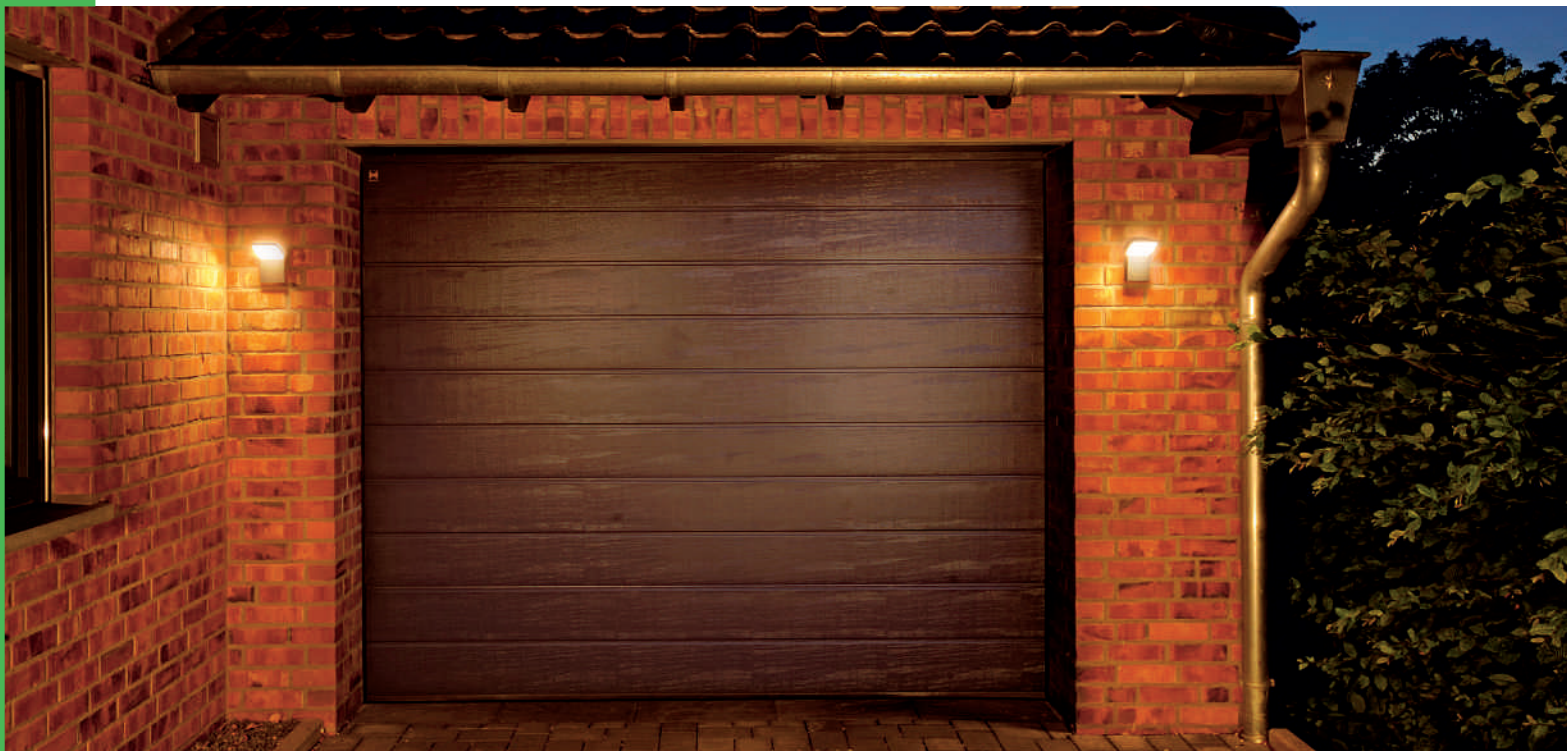

ORDI Wall light without sensor



220V~
-240V~



LED
48 pcs.



120°



0,37



Lamp [incl.]:

LED SMD LED
Total consumption: 9W

Material:
Aluminium

Dimensions:
W/H/D: 10/16,5/11 cm

Models:

3000K, 500lm, CRI 80
■ anthracite

Item no.:

LI232905



ORDI Wall light with sensor

+ With built-in infrared motion sensor



220V~
-240V~



LED
48 pcs.



120°



0,4



Lamp [incl.]:

LED SMD LED
Total consumption: 9W

Material:
Aluminium

Dimensions:
W/H/D: 10/16,5/11 cm



Models:

3000K, 500lm, CRI 80
■ anthracite

Item no.:

LI232915





ANGOLUX WALL



Lamp [incl.]:
 SMD LED, 6W
 Total consumption: 7,5W

Material:
 Aluminium/plastic

Dimensions:
 W/H/D: 17/8,6/13 cm

Accessories/Included:
 LED driver [incl.]

Note:
 To be installed with downwards-directed light emission only.

Models: 3000K, 500lm, CRI 80
 □ white **LI231351**
 ■ anthracite **LI231355**



IPERI WL



Lamp [incl.]:
 SMD LED, 4W
 Total consumption: 5W

Material:
 Aluminium/plastic

Note:
 To be installed with downwards-directed light emission only.

Models: 4000K, 320lm, CRI>70
 □ white **LI231311**
 ■ anthracite **LI231315**







+ WALLYX GU10

EEC= E-A++ 230V~ 0,67 IP44



Socket/Lamp [excl.]:
GU10 / QPAR51, 50W max.
up to max. length: 7,6 cm

Lamp options [excl.]:
LED

Material:
Aluminium/glass

Models:
 white
 silver-grey
 anthracite
 antique bronze

Item no.:
 LI227191
 LI227194
 LI227195
 LI227198

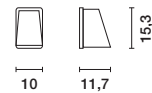

LED UPGRADE:
LED GU10 4,3W, 40°
2700K, 245lm, EEC=A+
5kWh/1000h
LI551252



+ TRICONE GU10

EEC= E-A++ 230V~ 0,7 IP44

↳ Suitable for longer lamps



Socket/Lamp [excl.]:
GU10 / QPAR51, 50W max.
up to max. length: 7,6 cm

Lamp options [excl.]:
LED

Material:
Aluminium/glass

Dimensions:
W/H/D: 12/18/13,8 cm
Canopy W/H: 6,5/9 cm

Models:
 white
 anthracite

Item no.:
 LI231701
 LI231705

LED UPGRADE:
PHILIPS Corepro LED Spot 3,5W, 36°
3000K, 245lm, EEC=A+
4kWh/1000h
LI560084





+ TERANG LED

↳ Ideal for useful lighting

EEC= A-A++
220V~ -240V~
(LED)
LED 1 Module
30000
↔
↕
↗
0,43
IP44
⊕

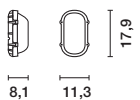

Lamp [incl.]:
 ↳ SMD LED
 Total consumption: 11W

Material:
 Aluminium/polycarbonate

Models:
 3000K, 680lm, CRI>80
 □ white
 ■ silver-grey
 ■ anthracite

Item no.:
 LI229921
 LI229924
 LI229925

■ rust **LI229927** NEW



↳ INSIDE

+ **+** TERANG 2

EEC= A-A++
220V~ -240V~
(LED)
LED 10 pcs.
20000
↔
↕
120°
↗
0,42
IP44
⊕

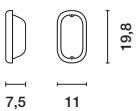

Lamp [incl.]:
 ↳ SMD LED
 Total consumption: 11W

Material:
 Aluminium/polycarbonate

Models:
 3000K, 680lm, CRI>80
 □ white
 ■ silver-grey
 ■ anthracite
 ■ rust

Item no.:
 LI229931
 LI229934
 LI229935
 LI229937



↳ INSIDE



+ **+** **TERANG 2 XL**



NEW

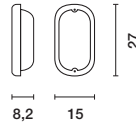

Lamp [incl.]:
 SMD LED
 Total consumption: 22W

Material:
 Aluminium/polycarbonate

Models:
 3000K, 1300lm, CRI>80

white
 silver-grey
 anthracite
 rust

Item no.:
 LI229941
 LI229944
 LI229945
 LI229947



+ **+** **GERMA**
 Wall light, single/double, 127 cm

- + Diffusor clip and mounting material stainless steel
- + Ideal for (underground) garages, car wash, warehouses



NEW

Socket/Lamp [excl.]:
 G13 / — T26
 36W [LI234101]
 2x 36W [LI234102]

Material:
 Polycarbonate/acrylic glass

Models:
 silver-grey

Item no.:
 Single LI234101
 Double LI234102

Dimensions:
 L/W/H: 126,5/9,2/9,9 cm [LI234101]
 L/W/H: 126,5/13,7/9,9 cm [LI234102]

LED UPGRADE:
 LED T8, 18W, 130°
 4000K, 1600lm, EEK=A+
 18kWh/1000h
 LI570074

Accessories/Included:
 Low-loss ballast [incl.]

LED UPGRADE:
 LED T8, 18W, 130°
 6500K, 1800lm, EEK=A+
 18kWh/1000h
 LI570076

+ **+** **GERMA**
 Wall light, single/double, 157 cm

- + Diffusor clip and mounting material stainless steel
- + Ideal for (underground) garages, car wash, warehouses



NEW

Socket/Lamp [excl.]:
 G13 / — T26
 58W [LI234111]
 2x 58W [LI234112]

Material:
 Polycarbonate/acrylic glass

Models:
 silver-grey

Item no.:
 Single LI234111
 Double LI234112

Dimensions:
 L/W/H: 156,5/9,2/9,9 cm [LI234111]
 L/W/H: 156,5/13,7/9,9 cm [LI234112]

LED UPGRADE:
 LED T8, 26W, 130°
 4000K, 2400lm, EEK=A+
 26kWh/1000h
 LI570084

Accessories/Included:
 Low-loss ballast [incl.]

LED UPGRADE:
 LED T8, 26W, 130°
 6500K, 2700lm, EEK=A+
 26kWh/1000h
 LI570086



MICRO FLAT

+ Triplex glass



EEC= B-A++ 230V~ 0,6 IP44

Socket/Lamp [excl.]:
GX53 / TCR-TSE, 9W max.

Lamp options [excl.]:

Material:
Aluminium/glass

Dimensions:
Ø/D: 8/13 cm

Models:
Glass frosted
■ silver-grey

Item no.:
LI229912

LED UPGRADE:

LED GX53, 3W, 120°
3000K, 250lm, EEC=A++
3kWh/1000h

LI551372



BULAN



EEC= E-A++ 230V~ 1,7 IP44

Socket/Lamp [excl.]:
E14 / C35, 60W max.
up to max. Ø/L: 4,8/13 cm

Lamp options [excl.]:
 QC35 / TC(...)/SE /

Material:
Aluminium/glass

Dimensions:
Ø/D: 27/7 cm

Models:
Glass frosted
 white

■ silver-grey

■ anthracite

Item no.:
LI229071

LI229072

LI229075

LED UPGRADE:

PHILIPS Corepro LED E14, 3W
2700K, 250lm, EEC=A+
3kWh/1000h

LI560222





BULAN GRID



230V~



IP44



Socket/Lamp [excl.]:

E27 / TC(...SE), 2x 25W max.
up to max. Ø/L: 5,2/17,3 cm

Lamp options [excl.]:



Material:

Aluminium/polycarbonate

Dimensions:

Ø/D: 27,5/8,5 cm

Models:

- white
- silver-grey
- anthracite
- rust

Item no.:

- LI229081**
- LI229084**
- LI229085**
- LI229087**

LED UPGRADE:

LED E27 Tube, 4,7W,
3000K, 380lm, EEC=A+
5kWh/1000h
LI551532







+ DRAGAN

For professional application

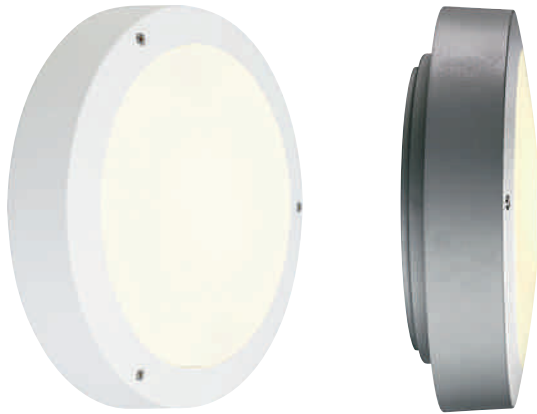

Socket/Lamp [excl.]:
G24d-3 / TC-D, 2x 26W

Material:
Aluminium/polycarbonate

Dimensions:
Ø/D: 35/10,5 cm

Accessories/Included:
Low-loss ballast [incl.]

Models:
 white
 silver-grey
 anthracite

Item no.:
LI230401
LI230404
LI230405

Recommended lamp:
26W, 2700K, 1800lm, EEC=B
32kWh/1000h
LI508226



+ DRAGAN Sensor

Motion sensor not visible
Connection of up to 6 additional fittings per sensor

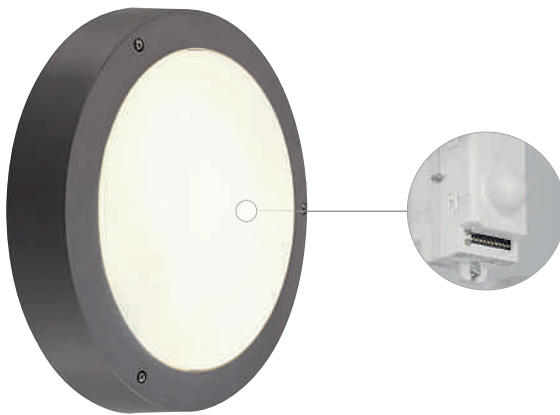

Socket/Lamp [excl.]:
E27 / TC(...)SE, 2x 24W max.
up to max. Ø/L: 5,2/15,2 cm

Lamp options [excl.]:
LED

Material:
Aluminium/polycarbonate

Dimensions:
Ø/D: 35/10,5 cm

Accessories/Included:
Microwave sensor [incl.]

Models:
 white
 silver-grey
 anthracite

Item no.:
LI232421
LI232424
LI232425

Recommended lamp:
PHILIPS Master Stairway ELT 20W
2700K, 1230lm, EEC=A
20kWh/1000h
LI508610



Note:
Coverage angle: 360°
Coverage distance: 2/5/8/10 m
The ambient brightness and time period activation can be set individually.

+ **+** INDIGLA

Asymmetrical reflector

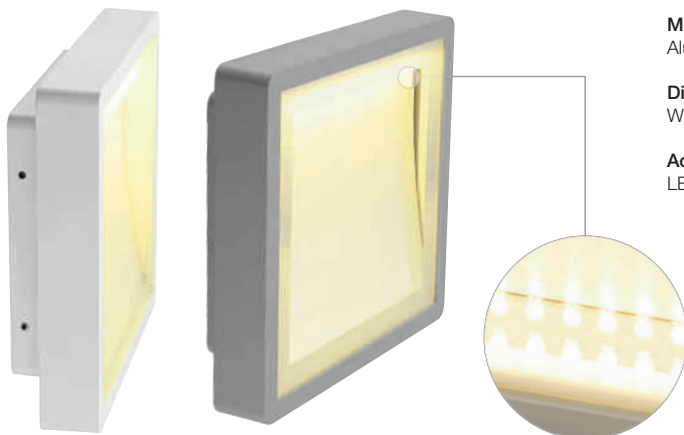

Lamp [incl.]:
SMD LED
Total consumption: 8,3W

Material:
Aluminium/glass

Dimensions:
W/H/D: 23,5/23,5/7 cm

Accessories/Included:
LED driver [incl.]

Models:
3000K, 430lm, CRI 80
 white
 silver-grey

Item no.:
LI230881
LI230884





 KERAS ELT

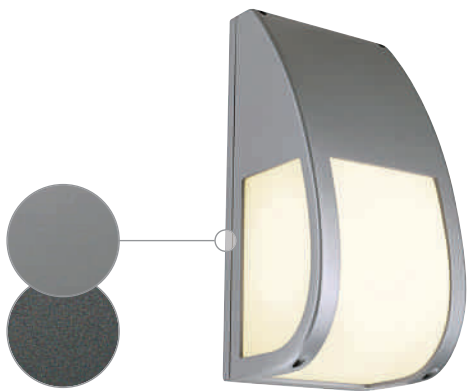

Socket/Lamp [excl.]:
E27 /  TC(...).SE, 25W max.
up to max. Ø/L: 7/17,5 cm

Lamp options [excl.]:

Material:
Aluminium/polycarbonate

Dimensions:
W/H/D: 13,5/29,5/12,8 cm

Models:
■ silver-grey
■ anthracite

Item no.:
LI227174
LI227176

LED UPGRADE:
PHILIPS Corepro LED E27, 9,5W,
dimmable
2700K, 806lm, EEC=A+
10kWh/1000h
LI560161





MERIDIAN 2

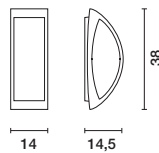
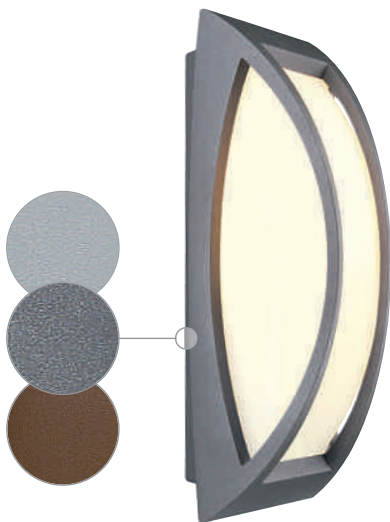

Socket/Lamp [excl.]:
E27 / TC(...), SE, 25W max.
up to max. Ø/L: 7/17,5 cm

Lamp options [excl.]:
LED

Material:
Aluminium/polycarbonate

Models:
■ silver-grey
■ anthracite

■ rust

Item no.:
LI230444
LI230445

LI230447

LED UPGRADE:

PHILIPS Corepro LED E27, 9,5W,
dimmable
2700K, 806lm, EEC=A+
10kWh/1000h
LI560161





MERIDIAN BOX with sensor



↳ Motion sensor not visible



Socket/Lamp [excl.]:
E27 / TC(...).SE, 25W max.
up to max. Ø/L: 7/17,5 cm

Models:
■ silver-grey
■ anthracite

Item no.:
L1230084
L1230085

Lamp options [excl.]:

■ rust

L1230087

Material:
Aluminium/polycarbonate

Accessories/Included:
Motion sensor with
MR technology [incl.]

LED UPGRADE:

PHILIPS Corepro LED E27, 9,5W,
dimmable
2700K, 806lm, EEC=A+
10kWh/1000h
L1560161



Note:
Coverage angle: 180°
Coverage distance: 1–5 m
The ambient brightness and time
period activation can be set indi-
vidually.
We recommend using switch-proof
lamps, such as Philips Stairway or
LED lamps.

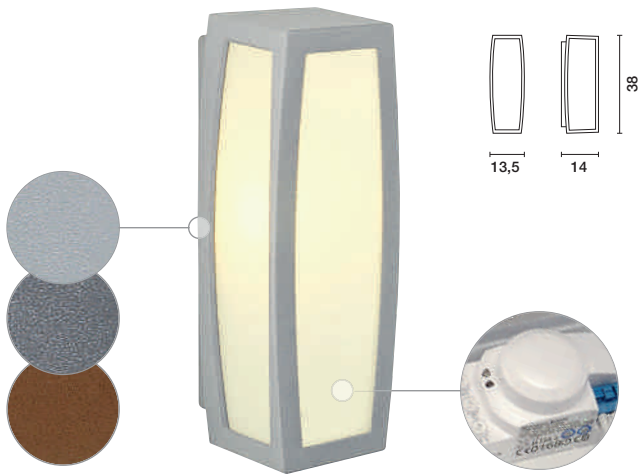

MERIDIAN BOX

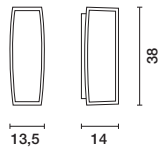

Socket/Lamp [excl.]:
E27 / TC(...).SE, 25W max.
up to max. Ø/L: 7/17,5 cm

Models:
■ silver-grey
■ anthracite

Item no.:
L1230044
L1230045

Lamp options [excl.]:

■ rust

L1230047

Material:
Aluminium/polycarbonate

LED UPGRADE:

PHILIPS Corepro LED E27, 9,5W,
dimmable
2700K, 806lm, EEC=A+
10kWh/1000h
L1560161

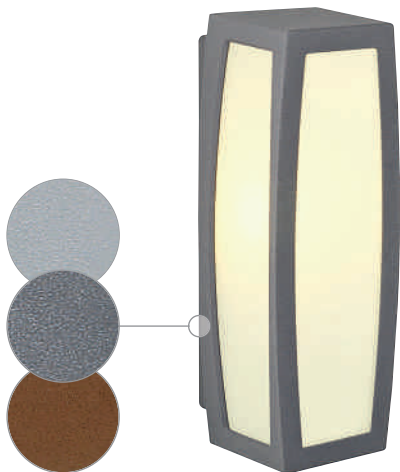



MERIDIAN 3

EEC= A-A++ 230V~ IP54

Socket/Lamp [excl.]:
E27 / TC(...), SE, 25W max.
up to max. Ø/L: 7/17,5 cm

- Models:**
- white
 - silver-grey
 - anthracite

Item no.:
LI230641
LI230644
LI230645

Lamp options [excl.]:

Material:
Aluminium/polycarbonate

Dimensions:
W/H/D: 13,5/37,5/14 cm

LED UPGRADE:
PHILIPS Corepro LED E27, 9,5W,
dimmable
2700K, 806lm, EEC=A+
10kWh/1000h
LI560161

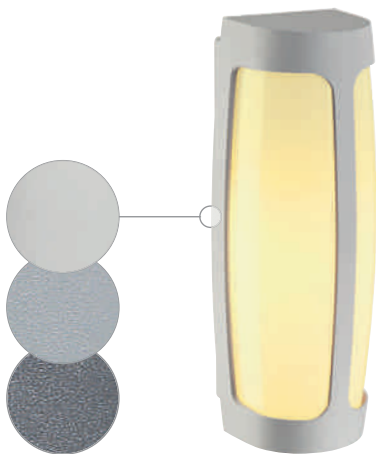

MERIDIAN BOX 2

EEC= A-A++ 230V~ IP54

Socket/Lamp [excl.]:
E27 / TC(...), SE, 25W max.
up to max. Ø/L: 7/17,5 cm

- Models:**
- anthracite
 - rust

Item no.:
LI230655
LI230657

Lamp options [excl.]:

Material:
Aluminium/polycarbonate





LED UPGRADE:
Vinta SMD LED E27, 4W,
2200K, 350lm, EEC=A+
4kWh/1000h
LI551761





NEW MYRA DISPLAY STRAIGHT

EEC= E-A++
230V-
←
↻
45°
0,69
IP55
⊕

-  603
-  606
-  645
-  707



>2,5mV
GR/GT

≤2,5mV
LED

ESL

Socket/Lamp [excl.]:
 GU10 / QPAR51, 50W max.
 up to max. Ø/H: 5/5,7 cm

Lamp options [excl.]:

Material:
 Aluminium

Dimensions:
 Product L: 50 cm
 Head Ø/L: 7/8 cm
 Canopy W/H/D: 8/10,5/5 cm

Models:
■ silver-grey
■ anthracite

Item no.:
■ L1233124
■ L1233125

LED UPGRADE:
PHILIPS Corepro LED 4,5W, 36°
 2700K, 345lm, EEC=A+
 5kWh/1000h
L1560182



Recommended accessory:
 Frame for surface mounting, aluminium
 Product W/H/D: 9,2/11,6/1,8 cm
 Weight: 1,08 kg
■ L1233214
■ L1233215



MYRA STRAIGHT

EEC= E-A++
230V-
←
↻
45°
0,65
IP55
⊕



>2,5mV
GR/GT

≤2,5mV
LED

ESL

Socket/Lamp [excl.]:
 GU10 / QPAR51, 50W max.

Lamp options [excl.]:

Material:
 Aluminium

Dimensions:
 Product L: 50 cm
 Head Ø/L: 7/8 cm
 Canopy W/H/D: 8/10,5/5 cm

Models:
■ silver-grey
■ anthracite

Item no.:
■ L1228842
■ L1228845

LED UPGRADE:
PHILIPS Corepro LED 4,5W, 36°
 2700K, 345lm, EEC=A+
 5kWh/1000h
L1560182



Recommended accessory:
 Frame for surface mounting, aluminium
 Product W/H/D: 9,2/11,6/1,8 cm
 Weight: 1,08 kg
■ L1233214
■ L1233215





ENOLA_C CURVED

- 563
- 647
- 703

± Premium LED



Lamp [incl.]:
 COB LED, 9W
 Total consumption: 11,2W

Material:
 Aluminium

Dimensions:
 Product L: ~70 cm
 Head L/Ø: 10/11,7 cm
 Canopy W/H/D: 8/10,5/5 cm

Accessories/Included:
 LED driver [incl.]

Models:
 3000K, 750lm, CRI>80
 white
 anthracite

Item no.:
 LI228531
 LI228535



Recommended accessory:
 Frame for surface mounting, aluminium
 Product W/H/D: 9,2/11,6/1,8 cm
 Weight: 1,08 kg
 LI233214
 LI233215



NEW MYRA DISPLAY CURVED

- 603
- 606
- 645
- 707



Socket/Lamp [excl.]:
 GU10 / QPAR51, 50W max.
 up to max. Ø/H: 5/5,7 cm

Lamp options [excl.]:

Material:
 Aluminium

Dimensions:
 Product L: 78 cm
 Head Ø/L: 7/8 cm
 Canopy W/H/D: 8/10,5/5 cm

Models:
 silver-grey
 anthracite

Item no.:
 LI233134
 LI233135

LED UPGRADE:

PHILIPS Corepro LED 4,5W, 36°
 2700K, 345lm, EEC=A+
 5kWh/1000h
 LI560182

Recommended accessory:
 Frame for surface mounting, aluminium
 Product W/H/D: 9,2/11,6/1,8 cm
 Weight: 1,08 kg
 LI233214
 LI233215



MYRA CURVED

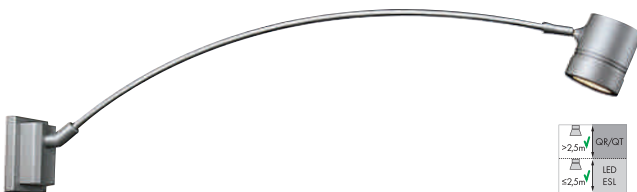

Socket/Lamp [excl.]:
 GU10 / QPAR51, 50W max.

Lamp options [excl.]:

Material:
 Aluminium

Dimensions:
 Product L: ~80 cm
 Head Ø/L: 7/8 cm
 Canopy W/H/D: 8/10,5/5 cm

Models:
 silver-grey
 anthracite

Item no.:
 LI228812
 LI228815

LED UPGRADE:

PHILIPS Corepro LED 4,5W, 36°
 2700K, 345lm, EEC=A+
 5kWh/1000h
 LI560182

Recommended accessory:
 Frame for surface mounting, aluminium
 Product W/H/D: 9,2/11,6/1,8 cm
 Weight: 1,08 kg
 LI233214
 LI233215







NAUTILUS SQUARE LED WL

EEC= A-A++ 100V-240V- 700mA LED 1 pce. 60000 180° 90° 45° IP54



± Premium LED



Lamp [incl.]:
 LED COB LED, 6,7W
 Total consumption: 9W

Models:
 3000K, 520lm, CRI 80
 ■ anthracite

Item no.:
 LI231045

Material:
 Aluminium/glass

Dimensions:
 Product W/H/D: 8/12,5/16 cm
 Head W/H/D: 8/7/8 cm
 Canopy W/H/D: 8/8/4 cm

Accessories/Included:
 LED driver [incl.]



BIG NAUTILUS SQUARE LED

EEC= A-A++ 100V-277V- 350mA LED 1 pce. 60000 180° 25° IP54



± Premium LED



Lamp [incl.]:
 LED COB LED
 Total consumption: 16,3W

Models:
 3000K, 950lm, CRI 80
 ■ anthracite

Item no.:
 LI231055

Material:
 Aluminium/glass

Dimensions:
 Product W/H/D: 10,5/15/18,7 cm
 Head W/H/D: 10,5/9,3/10,5 cm
 Canopy W/H/D: 10/10/4,3 cm

Accessories/Included:
 LED driver [incl.]



CV-SPOT WALL

EEC= A-A++ 230V- 180° IP44



± Stainless steel
 ± IP65

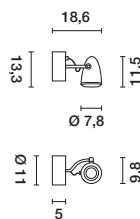

Socket/Lamp [excl.]:
 GU10 / LED GU10 51mm, 4W max.
 up to max. Ø/L: 5,1/5,7 cm

Material:
 Stainless steel 304

Models:
 ■ stainless steel brushed

Item no.:
 LI231662

Recommended lamp:
PHILIPS Corepro LED Spot 3,5W, 36°
 3000K, 245lm, EEC=A+
 4kWh/1000h
 LI560084



SITRA 360 WL

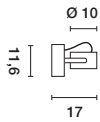
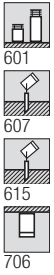

Socket/Lamp [excl.]:
GX53 / Ø TCR-TSE, 9W max.
up to max. Ø/H: 7,5/3,5 cm

Lamp options [excl.]:
LED

Material:
Aluminium/glass

Models:
■ stone grey
■ anthracite

Item no.:
LI231514
LI231515

LED UPGRADE:

LED GX53, 3W, 120°
3000K, 250lm, EEC=A++
3kWh/1000h
LI551372



LED UPGRADE:

LED GX53 4,2W, 35°
3000K, 200lm, EEC=A
5kWh/1000h
LI550092



EASYLITE® SPOT GU10

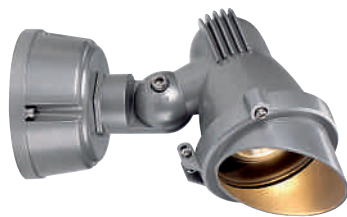

Socket/Lamp [excl.]:
GU10 / QPAR51, 50W max.

Lamp options [excl.]:
LED

Material:
Aluminium

Dimensions:
Product H: 20 cm
Head Ø/L: 10/15 cm
Base Ø/H: 10/5 cm

Models:
■ stone grey

Item no.:
LI230525

LED UPGRADE:

LED GU10 4,3W, 40°
2700K, 245lm, EEC=A+
5kWh/1000h
LI551252



Note:
The lamp head can be rotated by loosening the screw connection in the connection box.

NAUTILUS LED 304B

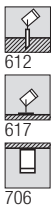

+ Stainless steel

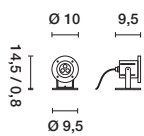

Lamp [incl.]:
LED PowerLED, 3x 1W
Total consumption: 4,5W

Material:
Stainless steel 304

Dimensions:
Connection lead L: 1,5 m

Accessories/Included:
LED driver [incl.]

Note:
Connection lead with open cable end.

Models:
3000K, 240lm, CRI 80
■ stainless steel brushed LI230802





MERVALED

± Premium LED



Lamp [incl.]:
 COB LED, 12W
 Total consumption: 14W

Models: 3000K, 750lm, CRI>80
 anthracite
Item no.: LI232415

Material:
 Aluminium/acrylic

Accessories/Included:
 LED driver [incl.]

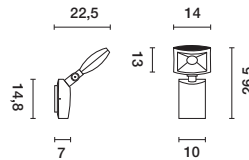

MERVALED S
 with motion sensor

± Premium LED



Lamp [incl.]:
 COB LED, 12W
 Total consumption: 14W

Models: 3000K, 750lm, CRI>80
 anthracite
Item no.: LI232405

Material:
 Aluminium/acrylic

Accessories/Included:
 LED driver [incl.]



Note:
 Coverage angle/distance: 140°/8 m
 Day/night mode
 Sensitivity and time period activation can be set individually.

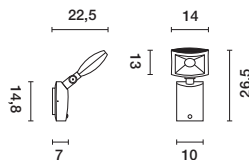



ROUND



SQUARE



SPOTS





BULAN

EEC= E-A++ 230V~ IP44



Socket/Lamp [excl.]:
E14 / C35, 60W max.
up to max. Ø/L: 4,8/13 cm

Models:
glass frosted
 white

Item no.:
LI229071

Lamp options [excl.]:
 QC35 / TC(...)SE /

silver-grey

LI229072

Material:
Aluminium/glass

anthracite

LI229075

Dimensions:
Ø/D: 27/7 cm

LED UPGRADE:

PHILIPS Corepro LED E14, 3W
2700K, 250lm, EEC=A+
3kWh/1000h
LI560222



BULAN GRID

EEC= E-A++ 230V~ IP44



Socket/Lamp [excl.]:
E27 / TC(...)SE, 2x 25W max.
up to max. Ø/L: 5,2/17,3 cm

Models:
 white
 silver-grey
 anthracite
 rust

Item no.:
LI229081
LI229084
LI229085
LI229087

Lamp options [excl.]:

Material:
Aluminium/polycarbonate

LED UPGRADE:

LED E27 Tube, 4,7W,
3000K, 380lm, EEC=A+
5kWh/1000h
LI551532





INDIGLA WING

- + Asymmetrical double reflector
- + Ideal for glare-free illumination of halls



EEC= A-A++
100V-277V-350mA
LED
72 pcs.
25000
2x45°
2,05
IP54

Lamp [incl.]:
 SMD LED, 6,13W
 Total consumption: 15W

Material:
 Aluminium/glass

Dimensions:
 W/H/D: 23,5/23,5/7 cm

Accessories/Included:
 LED driver [incl.]

Models:
 3000K, 2x 650lm, CRI 80
 white
 silver-grey

Item no.:
 LI230891
 LI230894



DRAGON Sensor

- + Motion sensor not visible
- + Up to 6 additional fittings can be connected to the sensor



EEC= A-A++
230V~
max. 250W
IP44

Socket/Lamp [excl.]:
 E27 / TC(...), 2x 24W max.
 up to max. Ø/L: 5,2/15,2 cm

Lamp options [excl.]:

Material:
 Aluminium/polycarbonate

Dimensions:
 Ø/D: 35/10,5 cm

Accessories/Included:
 Microwave sensor [incl.]

Note:
 Coverage angle: 360°
 Coverage distance: 2/5/8/10 m
 The ambiance brightness and time period activation can be set individually.

Models:
 white
 silver-grey
 anthracite

Item no.:
 LI232421
 LI232424
 LI232425

Recommended lamp:
PHILIPS Master Stairway ELT 20W
 2700K, 1230lm, EEC=A
 20kWh/1000h
 LI508610



DRAGON

- + For professional application



EEC= B
230V~
Ballast EEL=B2
IP44

Socket/Lamp [excl.]:
 G24d-3 / TC-D, 2x 26W

Material:
 Aluminium/polycarbonate

Dimensions:
 Ø/D: 35/10,5 cm

Accessories/Included:
 Low-loss ballast [incl.]

Models:
 white
 silver-grey
 anthracite

Item no.:
 LI230401
 LI230404
 LI230405

Recommended lamp:
 26W, 2700K, 1800lm, EEC=B
 32kWh/1000h
 LI508226



TERANG LED



+ Ideal for useful lighting

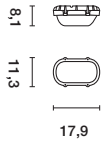

Lamp [incl.]:
 SMD LED
 Total consumption: 11W
Material:
 Aluminium/polycarbonate

Models:
 3000K, 680lm, CRI>80
 white
 silver-grey
 anthracite
 rust

Item no.:
 LI229921
 LI229924
 LI229925
 LI229927 **NEW**



TERANG 2

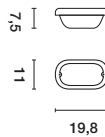
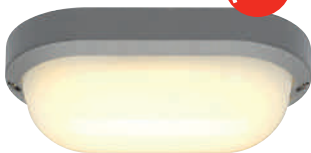

Lamp [incl.]:
 SMD LED
 Total consumption: 11W
Material:
 Aluminium/polycarbonate

Models:
 3000K, 680lm, CRI>80
 white
 silver-grey
 anthracite
 rust

Item no.:
 LI229931
 LI229934
 LI229935
 LI229937



TERANG 2 XL

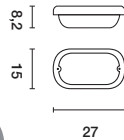
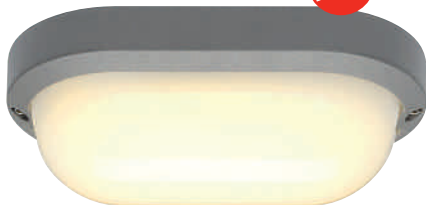

Lamp [incl.]:
 SMD LED
 Total consumption: 22W
Material:
 Aluminium/polycarbonate

Models:
 3000K, 1300lm, CRI>80
 white
 silver-grey
 anthracite
 rust

Item no.:
 LI229941
 LI229944
 LI229945
 LI229947





GERMA
Ceiling light, single/double, 127 cm

- + Diffusor clip and mounting material stainless steel
- + Ideal for (underground) garages, car wash, warehouses

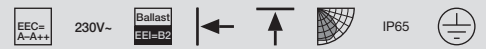

Socket/Lamp [excl.]:
G13 / — T26
36W [LI234101]
2x 36W [LI234102]

Models:
■ silver-grey
Single

Item no.:
LI234101

Material:
Polycarbonate/acrylic glass

Double

LI234102

Dimensions:
L/W/H: 126,5/9,2/9,9 cm [234101]
L/W/H: 126,5/13,7/9,9 cm [234102]

Accessories/Included:
Low-loss ballast [incl.]

LED UPGRADE:
LED T8, 18W, 130°
4000K, 1600lm, EEC=A+
18kWh/1000h
LI570074

LED UPGRADE:
LED T8, 18W, 130°
6500K, 1800lm, EEC=A+
18kWh/1000h
LI570076



GERMA
Ceiling light, single/double, 157 cm

- + Diffusor clip and mounting material stainless steel
- + Ideal for (underground) garages, car wash, warehouses

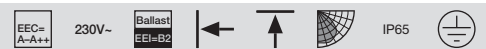

Socket/Lamp [excl.]:
G13 / — T26
58W [LI234111]
2x 58W [LI234112]

Models:
■ silver-grey
Single

Item no.:
LI234111

Material:
Polycarbonate/acrylic glass

Double

LI234112

Dimensions:
L/W/H: 156,5/9,2/9,9 cm [234111]
L/W/H: 156,5/13,7/9,9 cm [234112]

Accessories/Included:
Low-loss ballast [incl.]

LED UPGRADE:
LED T8, 26W, 130°
4000K, 2400lm, EEC=A+
26kWh/1000h
LI570084

LED UPGRADE:
LED T8, 26W, 130°
6500K, 2700lm, EEC=A+
26kWh/1000h
LI570086





+ QUADRASYL D

↳ Cover: stainless steel



EEC= B-A++ 230V~ IP23

Socket/Lamp [excl.]:
GX53 / Ø TCR-TSE, 9W max.
up to max. Ø/H: 7,5/2,1 cm

Lamp options [excl.]:

Material:
Aluminium/stainless steel 304

Dimensions:
W/H/D: 10,4/10,4/2,9 cm

Models:
■ stainless steel/
■ silver-grey **Item no.:**
LI111131

LED UPGRADE:

LED GX53, 3W, 120°
3000K, 250lm, EEC=A++
3kWh/1000h
LI551372



+ BIG THEO CEILING OUT GX53

- 237
- 305
- 659+
- 703



EEC= B-A++ 230V~ IP44

Socket/Lamp [excl.]:
GX53 / Ø TCR-TSE, 11 max.
up to max. Ø/L: 7,5/4 cm

Lamp options [excl.]:

Material:
Aluminium/glass

Dimensions:
W/H/D: 13/13/7 cm

Models:
Glass partially frosted
 white **Item no.:**
 silver-grey **▼ LI229981**
▼ LI229984

LED UPGRADE:

SMD LED 7,5W, 25°
3000K, 450lm, EEC=A
8kWh/1000h
LI550082



+ QUADRASYL 44D

↳ Cover: stainless steel



EEC= B-A++ 230V~ IP44

Socket/Lamp [excl.]:
GX53 / Ø TCR-TSE, 9W max.
up to max. Ø/H: 7,5/2,7 cm

Lamp options [excl.]:

Material:
Aluminium/glass
Cover: stainless steel 304

Dimensions:
W/H/D: 11/11/4,5 cm

Models:
Cover stainless steel
■ silver-grey **Item no.:**
LI111482

LED UPGRADE:

LED GX53, 3W, 120°
3000K, 250lm, EEC=A++
3kWh/1000h
LI551372





MICRO FLAT



Socket/Lamp [excl.]:
GX53 / TCR-TSE, 9W max.

Models:
Glass frosted
■ silver-grey

Item no.:
LI229912

Lamp options [excl.]:

Material:
Aluminium/glass

Dimensions:
Ø/H: 8/13 cm

LED UPGRADE:
LED GX53, 3W, 120°
3000K, 250lm, EEC=A++
3kWh/1000h
LI551372



ROX CEILING GX53 OUT

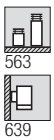

Socket/Lamp [excl.]:
GX53 / TCR-TSE, 11W max.
up to max. Ø/H: 7,5/3,5 cm

Models:
■ alu brushed

Item no.:
LI230726

Lamp options [excl.]:

Material:
Aluminium/glass

Dimensions:
Ø/H: 12,5/6 cm

LED UPGRADE:
SMD LED 7,5W, 25°
3000K, 450lm, EEC=A
8kWh/1000h
LI550082





ROX CEILING OUT

EEC= E-A++ 230V~ 0,8 IP44

-  255
-  563
-  639



Socket/Lamp [excl.]:
GU10 / QPAR111, 50W max.

Lamp options [excl.]:

Material:
Aluminium/glass

Dimensions:
Ø/H: 12,5/12,5 cm

Models:
■ alu brushed

Item no.:
L1229756

LED UPGRADE:
LED ES111, 17,5W, 30°
dimmable
2700K, 880lm, EEC=A
18kWh/1000h
L1551642





SITRA CEILING

EEC= B-A++ 230V~ 0,66 IP44

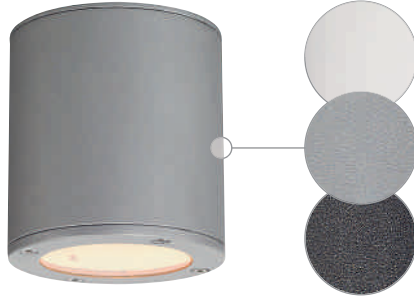
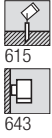

Socket/Lamp [excl.]:
GX53 / TCR-TSE, 9W max.

Lamp options [excl.]:
LED

Material:
Aluminium/glass

Dimensions:
Ø/H: 10/11 cm

Models:
 white
 stone grey
 anthracite

Item no.:
 LI231541
 LI231544
 LI231545

LED UPGRADE:
 LED GX53, 3W, 120°
 3000K, 250lm, EEC=A++
 3kWh/1000h
 LI551372



ENOLA_C OUT CL

EEC= A-A++ 100V~ -240V~ 500mA LED Module 4000K 35° IP55

+ Premium LED



Lamp [incl.]:
LED COB LED, 9W
Total consumption: 11,2W

Material:
Aluminium/glass

Dimensions:
Ø/H: 10/12,7 cm

Accessories/Included:
LED driver [incl.]

Models:
3000K, 750lm, CRI 80
 white
 anthracite

Item no.:
 LI228501
 LI228505



THEO CEILING OUT

EEC= E-A++ 230V~ 0,48 IP21

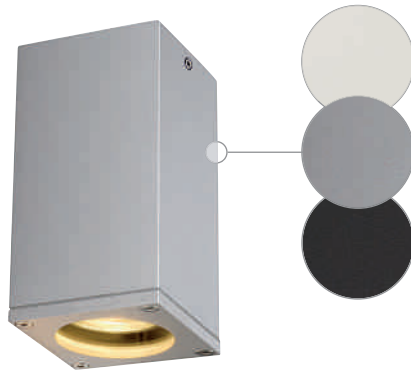
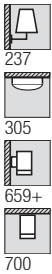

Socket/Lamp [excl.]:
GU10 / QPAR51, 35W max.
up to max. Ø/L: 5/5,8 cm

Lamp options [excl.]:
LED

Material:
Aluminium/glass

Dimensions:
L/W/H: 7/7/14 cm

Models:
 white
 silver-grey

Item no.:
 LI229581
 LI229584

anthracite **LI229585**

LED UPGRADE:
 LED GU10 4,3W, 40°
 2700K, 245lm, EEC=A+
 5kWh/1000h
 LI551252



BIG THEO CEILING OUT

EEC= E-A++ 230V~ 0,89 IP44

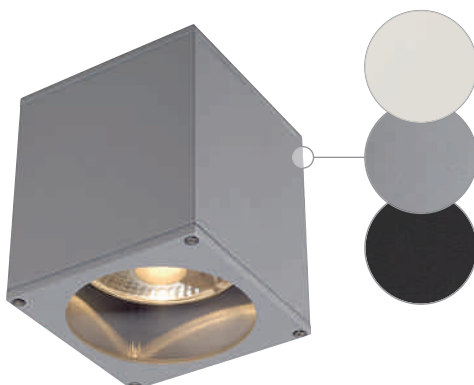
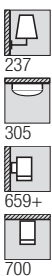

Socket/Lamp [excl.]:
GU10 / QPAR111, 75W max.

Lamp options [excl.]:
LED

Material:
Aluminium/glass

Dimensions:
W/H/D: 13/15/13 cm

Models:
 white
 silver-grey

Item no.:
 LI229551
 LI229554

anthracite **LI229555**

LED UPGRADE:
 LED ES111, 17,5W, 30°
 dimmable
 2700K, 880lm, EEC=A
 18kWh/1000h
 LI551642







LISENNE-0 Ceiling light

EEC= A-A++ 230V~ 2,6 IP44



Unobtrusive ceiling light with smoked glass appearance

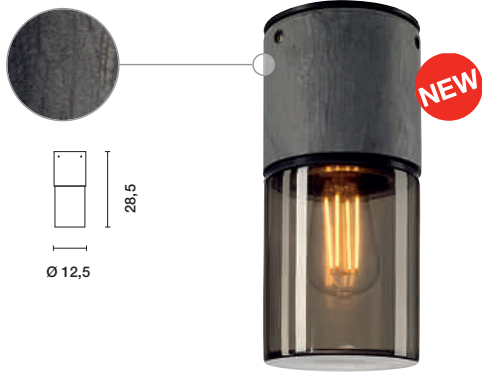

Socket/Lamp [excl.]:
E27 / TC(...)SE, 23W max.
up to max. Ø: 5,5 cm

Models:
■ stone grey

Item no.:
LI231361

Lamp options [excl.]:

Material:
Basalt

Dimensions:
Product Ø/H: 12/28,5 cm
Glass Ø/H: 12/15,5 cm
Base Ø/H: 12/12,5 cm

LED UPGRADE:
Vinta SMD LED E27, 4W,
2200K, 350lm, EEC=A+
4kWh/1000h
LI551761



GLOO PURE 27

EEC= A-A++ 230V~ 0,6 IP44

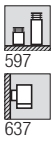

Genuine glass

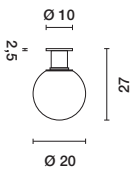

Socket/Lamp [excl.]:
E27 / TC(...)SE, 20W max.
up to max. Ø/L: 4,8/18 cm

Models:
■ Glass white
■ anthracite

Item no.:
LI232015

Lamp options [excl.]:

Material:
Steel/glass

Recommended lamp:
20W, 2700K, 1200lm, EEC=A
20kWh/1000h
LI508760



ROX ACRYL C

EEC= A-A++ 230V~ 0,7 IP44

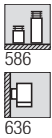

Alu brushed

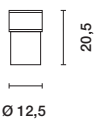

Socket/Lamp [excl.]:
E27 / TC(...)SE, 20W max.
up to max. Ø/L: 6/15 cm

Models:
■ alu brushed

Item no.:
LI230720

Lamp options [excl.]:

Material:
Aluminium/acrylic

Recommended lamp:
15W, 2700K, 970lm, EEC=A
15kWh/1000h
LI509012



SQUARE C

EEC= A-A++ 230V~ 10 1,3 IP44

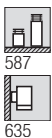

Alu brushed

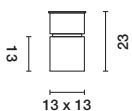

Socket/Lamp [excl.]:
E27 / TC(...)SE, 20W max.
up to max. Ø/H: 6/13 cm

Models:
■ alu brushed/lacquered

Item no.:
LI230716

Lamp options [excl.]:

Material:
Aluminium/acrylic

Recommended lamp:
15W, 2700K, 970lm, EEC=A
15kWh/1000h
LI509012



SITRA 360 WL

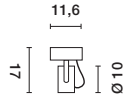
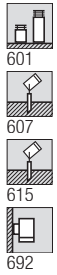

Socket/Lamp [excl.]:
GX53 / TCR-TSE, 9W max.
up to max. Ø/H: 7,5/3,5 cm

Lamp options [excl.]:
LED

Material:
Aluminium/glass

Models:
■ stone grey
■ anthracite

Item no.:
LI231514
LI231515

LED UPGRADE:
LED GX53 4,2W, 35°
3000K, 200lm, EEC=A
5kWh/1000h
LI550092



EASYLITE® SPOT GU10

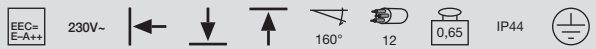

Lamp head can be adjusted and fixed using an allen key and can be tilted by loosening the screw joining in the connection box.

Socket/Lamp [excl.]:
GU10 / QPAR51, 50W max.

Lamp options [excl.]:
LED

Material:
Aluminium/glass

Dimensions:
Product H: 20 cm
Head Ø/L: 10/15 cm
Base Ø/H: 10/5 cm

Models:
■ stone grey

Item no.:
LI230525

LED UPGRADE:
LED GU10 4,3W, 40°
2700K, 245lm, EEC=A+
5kWh/1000h
LI551252



NAUTILUS LED 304B



✦ Stainless steel
✦ Premium LED

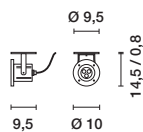

Lamp [incl.]:
LED PowerLED, 3x 1W
Total consumption: 4,5W

Material:
Stainless steel 304/glass

Dimensions:
Connection lead L: 1,5 m

Accessories/Included:
LED driver [incl.]

Note:
Connection lead with open cable end.

Models:
■ stainless steel brushed

Item no.:
3000K, 240lm, CRI 80 LI230802





MYRALED WALL



➤ Premium LED

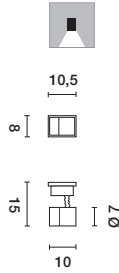

Lamp [incl.]:
 COB LED, 5W
 Total consumption: 6,8W

Material:
 Aluminium/glass

Accessories/Included:
 LED driver [incl.]

Models:
 3000K, 350lm, CRI 81
 silver-grey
 anthracite

Item no.:
 LI233204
 LI233205



Recommended accessory:
 Frame for surface mounting, aluminium
 Product W/H/D: 9,2/11,6/1,8 cm
 Weight: 1,08 kg
 LI233214
 LI233215



NEW MYRA WALL

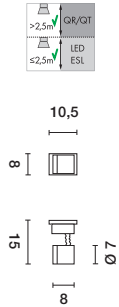
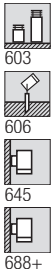

Socket/Lamp [excl.]:
 GU10 / QPAR51, 50W max.
 up to max. Ø/L: 5/5,7 cm

Lamp options [excl.]:

Material:
 Aluminium/glass

Recommended accessory:
 Frame for surface mounting, aluminium
 Product W/H/D: 9,2/11,6/1,8 cm
 Weight: 1,08 kg
 LI233214
 LI233215

Models:
 silver-grey
 anthracite

Item no.:
 LI233104
 LI233105

LED UPGRADE:
PHILIPS Corepro LED Spot 3,5W, 36°
 3000K, 245lm, EEC=A+
 4kWh/1000h
 LI560084



NEW MYRA WALL
 2 spots



➤ Lamp heads can be adjusted individually

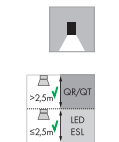

Socket/Lamp [excl.]:
 GU10 / QPAR51, 2x 50W max.
 up to max. Ø/L: 5/5,7 cm

Lamp options [excl.]:

Material:
 Aluminium/glass

Dimensions:
 W/H/D: 14,6/9,8/14,4 cm
 Head Ø/L: 6,8/7,8 cm
 Canopy W/H/D: 11,8/8/3,5 cm

Models:
 silver-grey
 anthracite

Item no.:
 LI233094
 LI233095

LED UPGRADE:
PHILIPS Corepro LED Spot 3,5W, 36°
 3000K, 245lm, EEC=A+
 4kWh/1000h
 LI560084





RECESSED WALL LIGHTS





BRICK MESH STAINLESS STEEL

↖ Cover: stainless steel 316

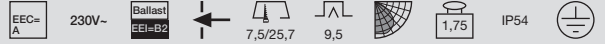
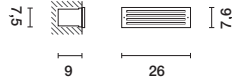

Socket/Lamp [excl.]:
G23 / TC-S, 9W

Models:
■ stainless steel

Item no.:
LI229250

Material:
Stainless steel 316/glass

Accessories/Included:
Low-loss ballast [incl.]

Recommended lamp:
9W, 2700K, 600lm, EEC=A
11kWh/1000h
LI508209



BRICK MESH STAINLESS STEEL LED

↖ Cover: stainless steel 316

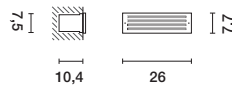

Lamp [incl.]:
SMD LED, 2,6W
Total consumption: 4W

Models:
3000K, 56lm, CRI 80
■ stainless steel

Item no.:
LI229110

Material:
Stainless steel 316/glass

Accessories/Included:
LED driver [incl.]



ALDA

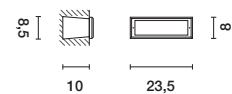

Socket/Lamp [excl.]:
G24d-2 / TC-D, 18W

Models:
■ stone grey

Item no.:
LI230415

Material:
Aluminium/plastic

Accessories/Included:
Low-loss ballast [incl.]
Installation pot [incl.]

Recommended lamp:
18W, 2700K, 1200lm, EEC=B
22kWh/1000h
LI508218





DOWNUNDER OUT LED S



Lamp [incl.]:
 SMD LED, 0,96W
 Total consumption: 1,7W

Material:
 Aluminium/plastic

Dimensions:
 W/H/D: 9/9/5 cm

Accessories/Included:
 Installation pot [incl.]
 LED driver [incl.]

Note:
 To be mounted with downwards-directed light emission only.

Models:	Item no.:
3000K, 40lm, CRI 80 <input type="checkbox"/> white	LI233601
3000K, 30lm, CRI 80 <input checked="" type="checkbox"/> silver-grey	LI233604
3000K, 25lm, CRI 80 <input checked="" type="checkbox"/> anthracite	LI233605



DOWNUNDER OUT LED L



Lamp [incl.]:
 SMD LED, 0,96W
 Total consumption: 3,3W

Material:
 Aluminium/plastic

Dimensions:
 W/H/D: 14/14/5 cm

Accessories/Included:
 Installation pot [incl.]
 LED driver [incl.]

Note:
 To be mounted with downwards-directed light emission only.

Models:	Item no.:
3000K, 155lm, CRI 80 <input type="checkbox"/> white	LI233611
3000K, 110lm, CRI 80 <input checked="" type="checkbox"/> silver-grey	LI233614
3000K, 85lm, CRI 80 <input checked="" type="checkbox"/> anthracite	LI233615



DOWNUNDER OUT LED M



Lamp [incl.]:
 SMD LED, 0,96W
 Total consumption: 3,3W

Material:
 Aluminium/plastic

Dimensions:
 W/H/D: 14/7/5 cm

Accessories/Included:
 Installation pot [incl.]
 LED driver [incl.]

Note:
 To be mounted with downwards-directed light emission only.

Models:	Item no.:
3000K, 155lm, CRI 80 <input type="checkbox"/> white	LI233621
3000K, 110lm, CRI 80 <input checked="" type="checkbox"/> silver-grey	LI233624
3000K, 85lm, CRI 80 <input checked="" type="checkbox"/> anthracite	LI233625





BRICK DOWNUNDER E14



Socket/Lamp [excl.]:
E14 / C35, 40W max.
up to max. Ø/L: 4,8/13 cm

Models: silver-grey **Item no.:** LI229062

Lamp options [excl.]:
 QC35 / TC(...)SE /

Material:
Aluminium/glass

LED UPGRADE:
PHILIPS Corepro LED E14, 3W
2700K, 250lm, EEC=A+
3kWh/1000h
LI560222

Note:
No installation pot required.

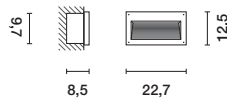

BRICK LED DOWNUNDER



Lamp [incl.]:
 SMD LED, 1W
Total consumption: 1,4W

Models: silver-grey **Item no.:**
 6500K, 35lm, CRI 80 **LI229701**
 3000K, 30lm, CRI 80 **LI229702**

Material:
Aluminium/glass

Dimensions:
W/H/D: 17/10,5/7 cm



Accessories/Included:
Installation pot [incl.]

BRICK LED DOWNUNDER VERTICAL



Lamp [incl.]:
 SMD LED, 0,7W
Total consumption: 1,2W

Models: silver-grey **Item no.:**
 3000K, 20lm, CRI 80 **LI229722**

Material:
Aluminium/glass

Dimensions:
W/H/D: 10,5/17/8,5 cm



Accessories/Included:
Installation pot [incl.]

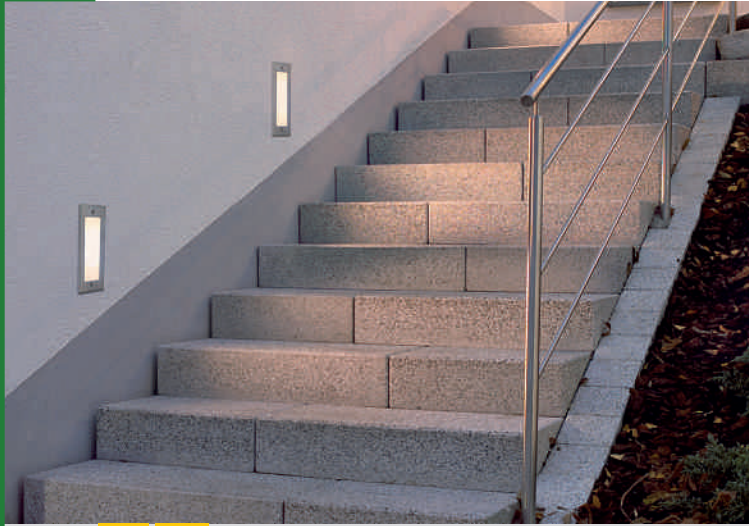

DOWNUNDER LED 14



230V~



LED
14 pcs.



11,5



7,2



max. 10



0,25



Lamp [incl.]:

LED SMD LED
Total consumption: 0,8W

Material:

Aluminium

Dimensions:

Ø/D: 12,5/6 cm
Installation pot Ø/D: 12/7,2 cm

Accessories/Included:

Installation pot [incl.]

Note:

IP44 with downwards-directed light emission only. Installation pot for application in brickwork only.

Models:

■ stone grey
6500K, 35lm, CRI>80

Item no.:

LI230201

3000K, 32lm, CRI>80

LI230202

■ alu brushed

6500K, 35lm, CRI>80

LI230301

3000K, 32lm, CRI>80

LI230302



DOWNUNDER LED 15



230V~



LED
15 pcs.



7,5/21



10



max. 10



0,45



Lamp [incl.]:

LED SMD LED
Total consumption: 0,9W

Material:

Aluminium

Dimensions:

W/H/D: 9/23/7,5 cm
Installation pot W/H/D: 9,5/23,5/9 cm

Accessories/Included:

Installation pot [incl.]

Note:

IP44 with downwards-directed light emission only. Installation pot for application in brickwork only.

Models:

■ stone grey
6500K, 38lm, CRI>80

Item no.:

LI230211

3000K, 35lm, CRI>80

LI230212

□ white

3000K, 35lm, CRI>80

LI230182

■ alu brushed

6500K, 38lm, CRI>80

LI230311

3000K, 35lm, CRI>80

LI230312



DOWNUNDER LED 27



230V~



LED
27 pcs.



16,5/21



10



max. 10



0,75



Lamp [incl.]:

LED SMD LED
Total consumption: 1,8W

Material:

Aluminium

Dimensions:

W/H/D: 18/23/7,5 cm
Installation pot W/H/D: 18,5/23,5/9 cm

Accessories/Included:

Installation pot [incl.]

Note:

IP44 with downwards-directed light emission only. Installation pot for application in brickwork only.

Models:

■ stone grey
6500K, 68lm, CRI>80

Item no.:

LI230221

3000K, 63lm, CRI>80

LI230222

□ white

3000K, 63lm, CRI>80

LI230192





DOWNUNDER OUT TC-D

For professional application

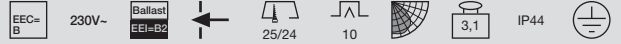
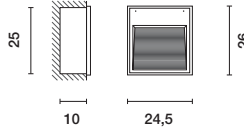

Socket/Lamp [excl.]:
G24d-3 / TC-D, 26W

Models:
■ silver-grey

Item no.:
LI230424

Material:
Aluminium/glass

Accessories/Included:
Low-loss ballast [incl.]
Installation pot [incl.]

Recommended lamp:
26W, 2700K, 1800lm, EEC=B
32kWh/1000h
LI508226



Note:
To be mounted with downwards-directed light emission only.



BRICK 16 LED STAINLESS STEEL

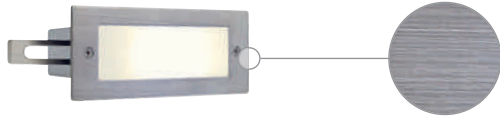

Lamp [incl.]:
SMD LED
Total consumption: 1W

Models:
■ stainless steel brushed
6500K, 30lm, CRI>80 LI230231
3000K, 30lm, CRI>80 LI230232

Material:
Stainless steel 304/plastic

Dimensions:
W/H/D: 17/6,8/8 cm

Accessories/Included:
Installation pot [incl.]



FRAME OUTDOOR 16 LED

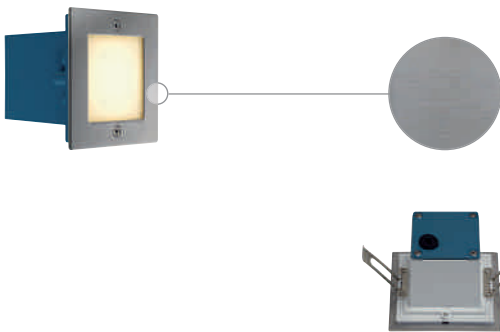

Lamp [incl.]:
SMD LED, 0,9W
Total consumption: 1,5W

Models:
■ stainless steel brushed
6500K, 40lm, CRI>80 LI230131
3000K, 40lm, CRI>80 LI230132

Material:
Stainless steel 304/plastic

Dimensions:
W/H/D: 10,5/10,5/8,2 cm
Installation pot W/H/D: 9,6/9,6/8,9 cm

Accessories/Included:
Installation pot [incl.]
Power supply unit [incl.]

Note:
Material thickness wall: 10–40 mm



BRICK 24 LED STAINLESS STEEL



Lamp [incl.]:
SMD LED
Total consumption: 1,6W

Models:
■ stainless steel brushed
6500K, 105lm, CRI 80 LI229121
3000K, 105lm, CRI 80 LI229122

Material:
Stainless steel 304/glass

Dimensions:
W/H/D: 16,5/10,5/7,5 cm

Accessories/Included:
Installation pot [incl.]





RECESSED CEILING LIGHTS





DOLIX OUT MR16
Clip springs – low-voltage

EEC=C-A+ 12V~ 7 13 IP65



+ Suitable for moist rooms

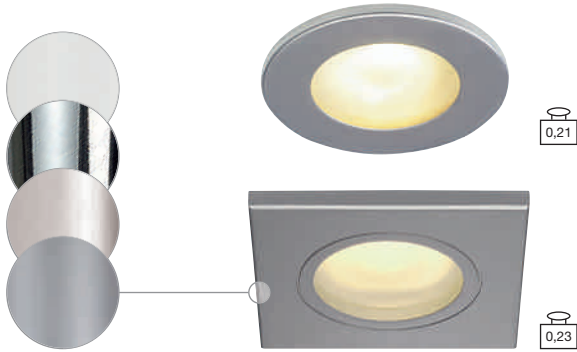

Socket/Lamp [excl.]:
GX5,3 / QR-C51, 35W max.

Models:
Glass frosted

Item no.:

Lamp options [excl.]:

Cover
 white

LI111001

Material:
Aluminium/glass

chrome

LI111002

Dimensions:
Material thickness ceiling: 20 mm max.

titanium
 silver-grey

LI111007
LI111008

Accessories/Included:
Transformer [excl.]

Cover
 white

LI111121

chrome

LI111122

titanium
 silver-grey

LI111127
LI111128

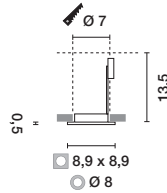

Recommended connection:
IP44 conventional transformer,
60VA/12V~
LI227160



Recommended lamp:
35W, 35°, 2900K, 450lm, EEC=C
38kWh/1000h
LI536338



DOLIX OUT GU10
Clip springs – high-voltage

EEC=E-A++ 230~ 7 13 IP44



+ Suitable for moist rooms



Socket/Lamp [excl.]:
GU10 / QPAR51, 35W max.

Models:
Glass frosted

Item no.:

Lamp options [excl.]:

Cover
 white

LI111021

Material:
Aluminium/glass

chrome

LI111022

Dimensions:
Material thickness ceiling: 15 mm max.

silver-grey
 titanium

LI111024
LI111027

Cover
 white

LI111141

chrome

LI111142

silver-grey
 titanium

LI111144
LI111147

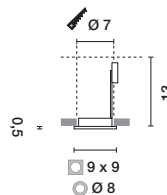

LED UPGRADE:

LED GU10 4,3W, 40°
2700K, 245lm, EEC=A+
5kWh/1000h
LI551252





OUT 65 round/square
Clip springs – high-voltage

- + High IP safety class (protection glass)
- + Premium LED



Lamp [incl.]:
1 COB LED
Total consumption: 12W

Material:
Aluminium/glass

Accessories/Included:
LED driver [incl.]

Note:
Material thickness ceiling: 20 mm

Models:	Item no.:
Glass frosted 3000K, 460lm, CRI 80	
○ Cover	
■ black	LI114460
□ white	LI114461
■ silver-grey	LI114464
■ titanium	LI114467
○ Cover	
■ black	LI114470
□ white	LI114471
■ silver-grey	LI114474
■ titanium	LI114477

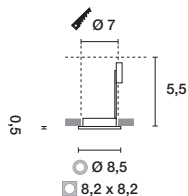



OUT 65
Low-voltage

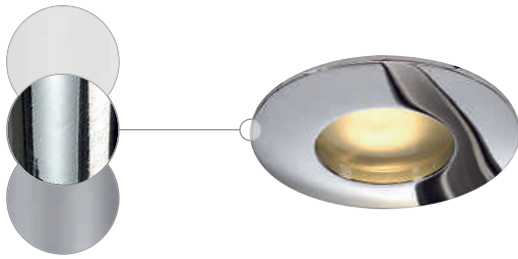

Socket/Lamp [excl.]:
GX5,3 / Φ QR-C51, 35W max.

Models:
Glass frosted
 white

Item no.:
LI111011

Lamp options [excl.]:

chrome

LI111018

Material:
Aluminium/glass

silver-grey

LI111019

Accessories/Included:
Transformer [excl.]

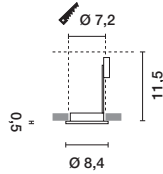

Recommended connection:
IP44 conventional transformer,
60VA/12V-
LI227160



Recommended lamp:
35W, 35°, 2900K, 450lm, EEC=C
38kWh/1000h
LI536338



PATTA-F
Ceiling recessed light, round/square

- + High IP safety class (protection glass)
- + For ceiling thickness up to 20 mm
- + Clip springs
- + Premium LED



Lamp [incl.]:
 COB LED
Total consumption: 12W

Models:
3000K, CRI 80
 Cover
 black
 white

Item no.:
630lm LI114440
765lm LI114441

Material:
Aluminium/glass

Dimensions:
 Φ /H: 8,3/6,2 cm
 L/W/H: 8,3/8,3/6,2 cm
Material thickness ceiling: 20 mm max.

Cover
 black
 white
630lm LI114450
765lm LI114451

Accessories/Included:
LED driver [incl.]

Note:
Protection glass covers front completely.

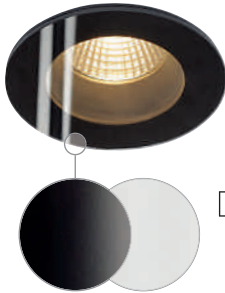

PATTA-I
Ceiling recessed light, round/square

- + High IP safety class (protection glass)
- + For ceiling thickness up to 25 mm
- + Clip springs
- + Premium LED



Lamp [incl.]:
 COB LED
Total consumption: 12W

Models:
3000K, CRI 80
 Cover
 black
 white

Item no.:
775lm LI114420
800lm LI114421

Material:
Aluminium/glass

Dimensions:
 Φ /H: 8/4,5 cm
 L/W/H: 8/8/4,5 cm
Material thickness ceiling: 25 mm max.

alu brushed
800lm LI114426

Accessories/Included:
LED driver [incl.]

Cover
 black
 white
 alu brushed
775lm LI114430
800lm LI114431
800lm LI114436





[L1228244] | page 739

TELESCOPE



729



735



ROUND



SQUARE - WINDOW ROUND



SQUARE - WINDOW SQUARE

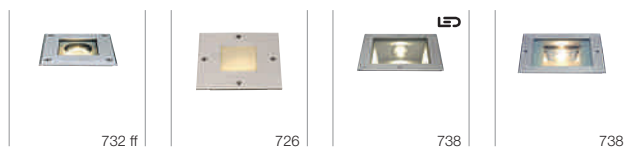

PROFILES





DASAR LED HV



230V~



LED
3 pcs.



25000



8,2



10,2



44,8°C



1 t



5 J



40°



0,53

IP67

- + Cover: stainless steel 316
- + Premium LED

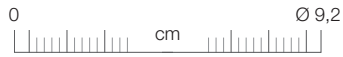

Lamp [incl.]:

LED PowerLED, 5W
Total consumption 5,5W

Material:

Aluminium/stainless steel 316

Dimensions:

Product Ø/D: 9,2/9,4 cm
Cover Ø/D: 9,2/0,4 cm
Connection lead L: 1,5 m

Accessories/Included:

Installation pot [incl.]
LED driver [incl.]

Note:

Connection lead: open cable end.

Models:

■ stainless steel brushed
3000K, 300lm, CRI 80 **LI233520**

Item no.:



DASAR LED HV PRO



230V~



LED
3 pcs.



25000



8,2



10,2



44,8°C



1 t



5 J



40°



0,73

IP67

- + Housing and cover: stainless steel 316
- + Premium LED



Lamp [incl.]:

LED PowerLED, 5W
Total consumption 5,5W

Material:

Stainless steel 316

Dimensions:

Product Ø/D: 9,2/9,4 cm
Cover Ø/D: 9,2/0,4 cm
Connection lead L: 1,5 m

Accessories/Included:

Installation pot [incl.]
LED driver [incl.]

Note:

Connection lead: open cable end.

Models:

■ stainless steel brushed
3000K, 300lm, CRI 80 **LI233530**

Item no.:





DASAR LED LV



12V= or 24V=



LED 3 pcs.



Cover: stainless steel 316



NEW



Lamp [incl.]:

LED PowerLED, 6W

Material:

Aluminium/stainless steel 316

Dimensions:

Product Ø/D: 9,2/6 cm
Cover Ø/D: 9,2/0,4 cm
Connection lead L: 1,5 m

Accessories/Included:

Installation pot [incl.]
Power supply unit [excl.]

Note:

Connection lead: open cable end.

Models:

■ stainless steel brushed
3000K, 360lm, CRI 80

Item no.:

LI233500



Recommended connection:

LED power supply 12W, 24V=
LI470502



Recommended connection:

LED power supply 12W, 12V=
LI470507



Recommended accessory:

Transformer box IP67
L/W/H: 29,5/4,5/6,0 cm
LI229261



DASAR LED LV PRO



12V= or 24V=



LED 3 pcs.



Housing and cover: stainless steel 316



NEW



Lamp [incl.]:

LED PowerLED, 6W

Material:

Stainless steel 316

Dimensions:

Product Ø/D: 9,2/6 cm
Cover Ø/D: 9,2/0,4 cm
Connection lead L: 1,5 m

Accessories/Included:

Installation pot [incl.]
Power supply unit [excl.]

Note:

Connection lead: open cable end.

Models:

■ stainless steel brushed
3000K, 360lm, CRI 80

Item no.:

LI233510



Recommended connection:

LED power supply 12W, 24V=
LI470502



Recommended connection:

LED power supply 12W, 12V=
LI470507



Recommended accessory:

Transformer box IP67
L/W/H: 29,5/4,5/6,0 cm
LI229261







TRAIL-LITE

+ Cover: stainless steel 316



with frosted glass insert

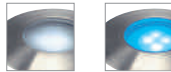

with prismatic diffuser



EEC=A-A++ 12V- LED 4 pcs. 4 7 28°C 0,15 IP65

Lamp [incl.]:
LED, 0,3W

Material:
Stainless steel 316/glass

Dimensions:
Fitting Ø/H: 3,6/6 cm
Cover Ø: 6 cm
Sleeve Ø/H: 4/7 cm
Connection lead L: 44 cm

Accessories/Included:
Installation sleeve [incl.]
Conventional transformer [excl.]

Note:
Operation with conventional transformer only.

Models:
■ stainless steel with frosted glass insert
6500K, 10lm, CRI>80 **LI227461**
3500K, 10lm, CRI>80 **LI227462**
with prismatic diffuser
6500K, 10lm, CRI>80 **LI227471**
3500K, 10lm, CRI>80 **LI227472**



Recommended connection:
IP44 transformer, 10VA/12V-
LI227140



POWER TRAIL-LITE round/square

+ Cover: stainless steel 316
+ PowerLED



Power Trail-Lite round



Power Trail-Lite square with installation sleeve



EEC=A-A++ 350mA LED 1 pce. 4 9 30°C 60° 0,3 IP67

Lamp [incl.]:
PowerLED, 1W

Material:
Stainless steel 316/glass

Dimensions:
○ Fitting Ø/H: 2,8/6,5 cm
○ Cover Ø: 4,1 cm

□ Fitting Ø/H: 2,8/6,7 cm
□ Cover L/W/H: 4,7/4,7/0,75 cm

Sleeve Ø/H: 3,9/9 cm
Connection lead L: 2 m

Accessories/Included:
Installation sleeve [incl.]
LED driver [excl.]

Note:
Operation with driver 350mA only.
Wiring of several PowerLEDs in series connection only.

Models:
■ stainless steel with frosted glass insert
○ Power Trail-Lite round
5700K, 60lm, CRI>70 **LI228331**
3000K, 45lm, CRI>80 **LI228332**
LED blue **LI228337**

□ Power Trail-Lite square
5700K, 60lm, CRI>70 **LI228341**
3000K, 45lm, CRI>80 **LI228342**



Recommended connection:
LED driver 3W, 350mA
LI464108



Recommended accessory:
Connection box round
2 inlets for thin wires
6-9,5 mm²
LI229260
Also suitable for intake of driver [LI464108/-200].



DASAR LED MINI

+ Stainless steel 316, entire housing
+ Slim collar- lamp stays back



NEW

EEC=A-A++ 12V= 24V= LED 1 Module 2500K 3 8 0,25 t 31° 0,33 IP67

Lamp [incl.]:
PowerLED, 2W

Material:
Stainless steel 316/glass

Dimensions:
○ Ø/H: 3,7/6,7 cm
□ L/W/H: 3,7/3,7/6,7 cm
Connection lead L: 1,5 m

Note:
Fitting is suitable for installation in wood.

Models:
■ stainless steel brushed
3000K, 120lm, CRI 80
○ Cover **LI233540**

□ Cover **LI233550**



Recommended connection:
LED power supply 12W, 24V=
LI470502



Recommended connection:
LED power supply 12W, 12V=
LI470507







DASAR® FLAT LED 230V



- + Cover: stainless steel
- + Particularly flat built



Lamp [incl.]:
 LED PowerLED Module
 Total consumption: 4,3W

Material:
 Cover: stainless steel 304
 Housing: alu diecasting

Dimensions:
 Ø/H: 8/5,8 cm
 Cover Ø: 8 cm
 Connection lead L: 1,5 m

Accessories/Included:
 Installation pot [incl.]

Models: ■ stainless steel brushed
 5000K, 150lm, CRI 80
 3000K, 140lm, CRI 80

Item no.:
LI228411
LI228412



DASAR® FLAT LED



- + Cover: stainless steel
- + Particularly flat built



Lamp [incl.]:
 LED, 0,8W

Material:
 Cover: stainless steel 304
 Housing: plastic

Dimensions:
 Ø/H: 8/4,8 cm
 Cover Ø: 8 cm
 Connection lead L: 2 m

Accessories/Included:
 Installation pot [incl.]
 Conventional transformer [excl.]

Note:
 Not to be walked on.
 Operation with conventional transformer only. When connection several fittings, please keep the total wattage in mind.

Models: ■ stainless steel brushed
 6500K, 25lm, CRI>80
 3000K, 25lm, CRI>80

Item no.:
LI228401
LI228402



Recommended connection:
 IP44 transformer, 10VA/12V~
LI227140

DASAR® 115 LED



- + Cover: stainless steel 316
- + Particularly flat built

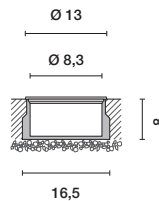

Lamp [incl.]:
 LED, 3,8W

Material:
 Stainless steel 316/aluminium

Accessories/Included:
 Installation pot [incl.]
 Conventional transformer [excl.]

Note:
 Operation with conventional transformer only. When connection several fittings, please keep the total wattage in mind.

Models: ■ stainless steel
 5000K, 55lm, CRI>80
 3000K, 50lm, CRI>80

Item no.:
LI229311
LI229312



Recommended connection:
 IP44 transformer, 10VA/12V~
LI227140

DASAR® GX53



- + Cover: stainless steel 316
- + Particularly flat built

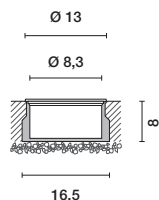

Socket/Lamp [excl.]:
 GX53 / Ø TCR-TSE, 9W max.
 up to max. Ø/L: 7,5/2,7 cm

Lamp options [excl.]:
 LED

Material:
 Stainless steel 304/aluminium

Accessories/Included:
 Installation pot [incl.]

Models: ■ stainless steel
Item no.:
LI229360

LED UPGRADE:
 LED GX53, 3W, 120°
 3000K, 250lm, EEC=A++
 3kWh/1000h
LI551372



WETSY LED DISK 300



230V~



Module 1 LED



+ Cover: stainless steel 316



Lamp [incl.]:

Module, 7,7W

Material:

Stainless steel 316/aluminium/glass

Dimensions:

Connection lead L: 1,4 m

Dimensions:

- Fitting H: 10 cm
- Cover Ø/H: 13,2/0,3 cm

□ Fitting H: 10 cm

□ Cover L/W/H: 13,2/13,2/0,75 cm

Accessories/Included:

Installation pot [incl.]

Models:

- Glass partially frosted
- stainless steel
- 2700K, 300lm, CRI 80
- Cover
- Cover

Item no.:

LI230170
LI230174



WETSY POWER LED



100V~
-240V~
320mA



LED 3 pcs.



+ Cover: stainless steel 316



Lamp [incl.]:

PowerLED, 3x 1W
Total consumption: 5W

Material:

Stainless steel 316/aluminium/glass

Dimensions:

Connection lead L: 1,4 m

Dimensions:

- Fitting H: 10 cm
- Cover Ø: 13,2 cm

□ Fitting H: 10 cm

□ Cover L/W: 13,2/13,2 cm

Accessories/Included:

Installation pot [incl.]
LED driver [incl.]

Models:

- Glass partially frosted
- Cover
- stainless steel
- 5700K, 295lm, CRI>70
- 3000K, 200lm, CRI>80

Item no.:

LI227421
LI227422

○ Cover

■ stainless steel

5700K, 295lm, CRI>70
3000K, 200lm, CRI>80

LI227431
LI227432



WETSY

+ Cover: stainless steel 316

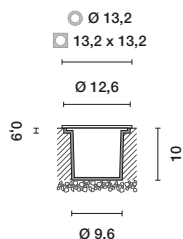

230V~



Socket/Lamp [excl.]:

GX53 / Ø TCR-TSE, 9W max.
up to max. Ø/L: 7,5/3,5 cm

Lamp options [excl.]:



Material:

Stainless steel 316/aluminium/glass

Dimensions:

Connection lead L: 1,4 m

Accessories/Included:

Installation pot [incl.]

Models:

- Glass frosted
- stainless steel
- Cover

Item no.:

LI227485

□ Cover

Window round
Window square

LI227490
LI227495

UPGRADE:

LED GX53, 3W, 120°
3000K, 250lm, EEC=A++
3kWh/1000h
LI551372



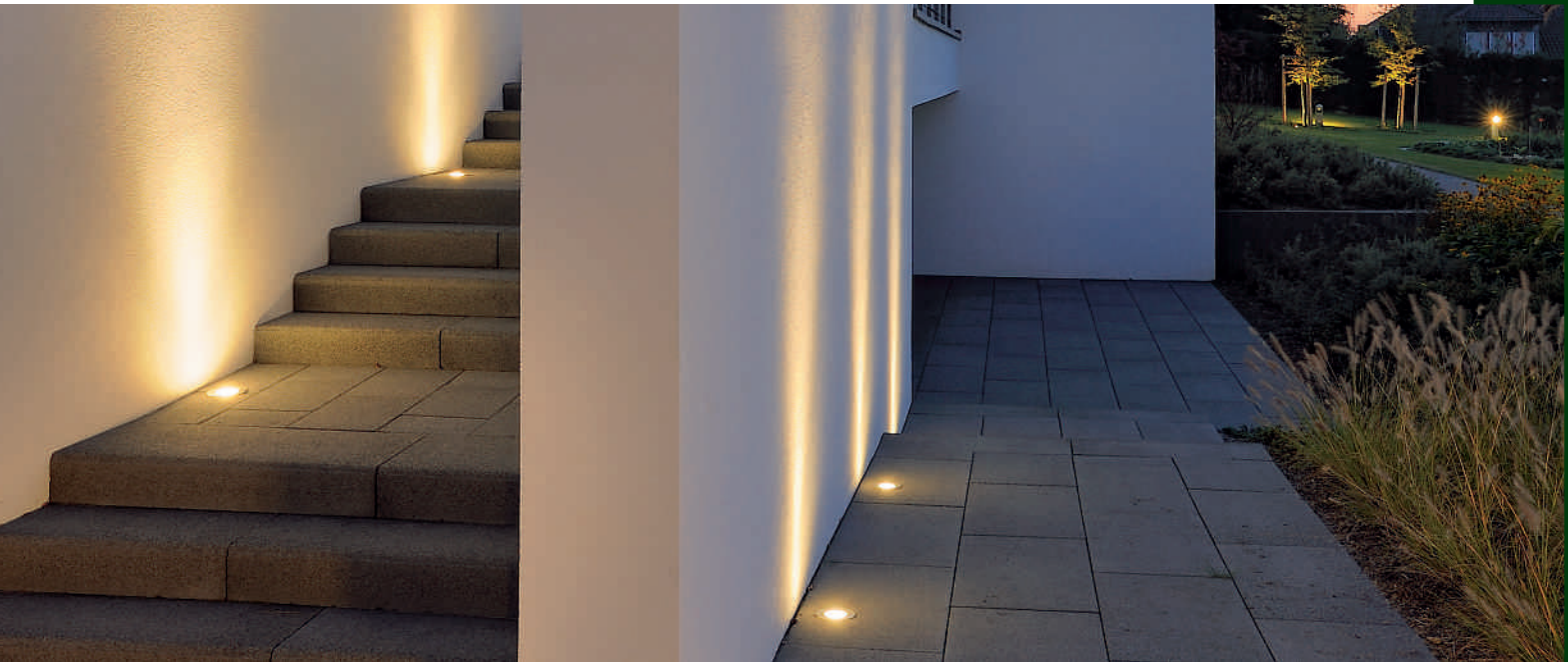

+ + + **DASAR® MODUL LED**
EEC= A-A++
230V~
↓
20
18
11
40°C
2 t
5 J
120°
3,35
IP67
⊕

- + Cover: stainless steel 316
- + For professional application



Socket/Lamp [excl.]:
PHJ65-d/ LED Twistable Module, 20W max.

Material:
Stainless steel 316/aluminium/glass

Dimensions:
 Fitting H: 16 cm
 Cover Ø/H: 21,6/0,4 cm
 Fitting H: 16 cm
 Cover L/W/H: 21,6/21,6/0,4 cm

Accessories/Included:
Installation pot [incl.]

Models:
 stainless steel
 Cover **LI230160**
 Cover **LI230164**

LED UPGRADE:
PHILIPS SMD LED, 1100lm, EEC=A
 dimmable
 15W, 4000K, 15kWh/1000h
LI560201
 16W, 3000K, 16kWh/1000h
LI560202

+ + + **ROCCI**
EEC= A-A++
200V~ -240V~ 700mA
LED
Module 1 COB LED
80000
↓
11,3
12,3
7-13
120°
IP67
⊕

- + Cover: stainless steel 316



Lamp [incl.]:
LED COB LED, 6W
Total consumption: 9,8W

Material:
Stainless steel 316/aluminium/glass

Dimensions:
 Fitting Ø/H: 12,5/11,7 cm
 Cover Ø/H: 12,5/0,4 cm
 Fitting L/W/H: 12,6/12,6/11,7 cm
 Cover L/W/H: 12,6/12,6/0,4 cm

Accessories/Included:
Installation pot [incl.]
LED driver [incl.]

Models:
 stainless steel
 Cover **LI227600**
 Cover **LI227604**

LED INSIDE





AQUADOWN MICRO



Socket/Lamp [excl.]:
G4 / \leq QR-CBC35, 20W max.

Lamp options [excl.]:
LED

Material:
Aluminium

Dimensions:
Cover \varnothing : 9,3 cm
Fitting H: 9,2 cm
Installation pot \varnothing /H: 12/10 cm
Connection lead L: 1,5 m

Accessories/Included:
Installation pot [incl.]
Transformer [excl.]

Models:
1 slot
4 slots

Item no.:
LI228301
LI228304

Recommended connection:
IP44 conventional transformer,
60VA/12V-
LI227160

GIMBLE OUT 90



- † To be tilted
- † Rotatable



Socket/Lamp [excl.]:
GX5,3 / \leq QR-CBC51, 35W max.

Lamp options [excl.]:
\leq QR-C51 / LED

Material:
Aluminium/glass

Dimensions:
 \varnothing /H: 15/21 cm
Cover \varnothing : 15 cm
Tilting range: 12 cm max.

Accessories/Included:
Installation pot [incl.]
Transformer [excl.]

Note:
Not to be walked on.
Adjustable during installation.

Models:
■ alu brushed
■ anthracite

Item no.:
LI228360
LI228365

LED UPGRADE:
LED MR16 3,8W
2700K, 225lm, EEC=A+
5kWh/1000h
LI551242

Recommended connection:
IP44 conventional transformer,
60VA/12V-
LI227160

Recommended connection:
IP44 transformer, 10VA/12V-
LI227140



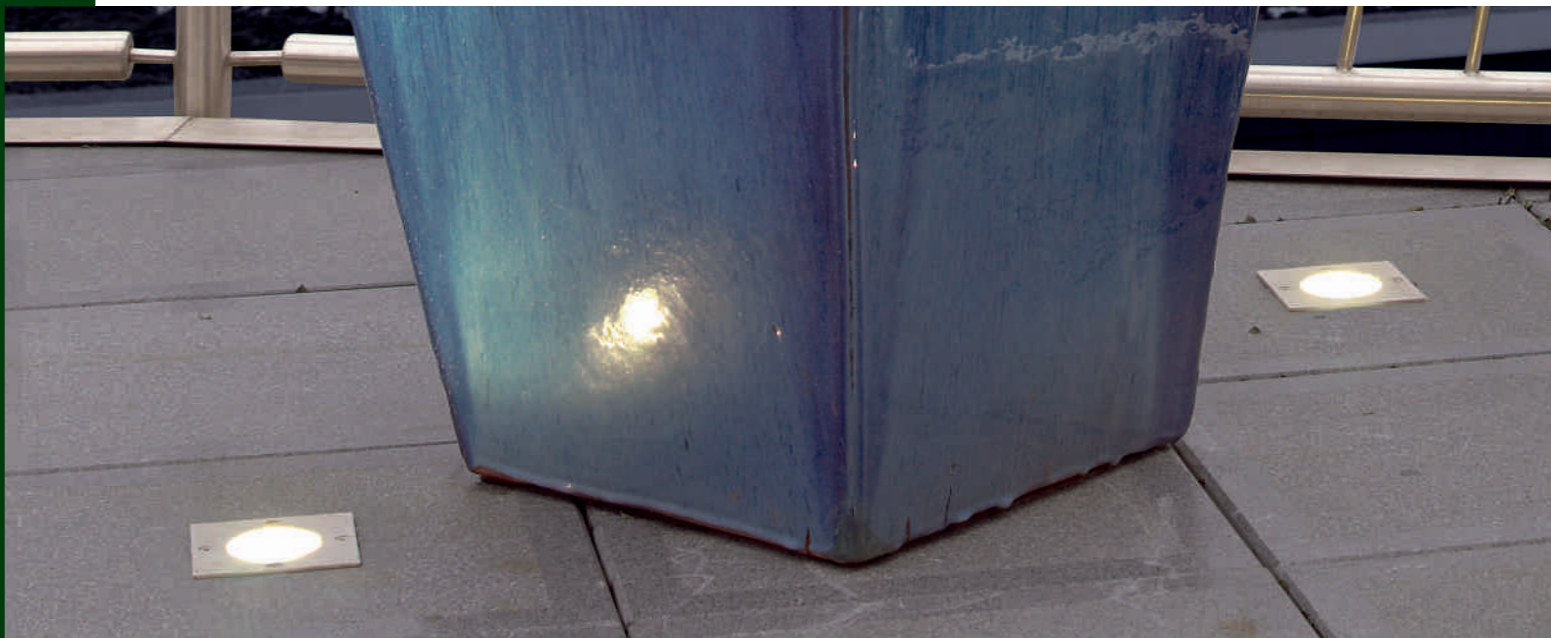

N-TIC PRO MR16 stainless steel



- + Housing and cover: stainless steel 316
- + Extremely resistant to corrosion

Socket/Lamp [excl.]:
GU5,3 / QR-CBC51, 35W max.

Lamp options [excl.]:
 QR-C51 /

Material:
Stainless steel 316/glass

Accessories/Included:
Installation pot [incl.]
Transformer [excl.]

Note:
The entire housing of N-tic Pro is made of **stainless steel cast 316** and thus also suitable for professional application.

Models:
 stainless steel brushed
 Cover **LI230900**
 Cover **LI230904**

UPGRADE:

LED MR16 3,8W
2700K, 225lm, EEC=A+
5kWh/1000h
LI551242



Recommended connection:

IP44 conventional transformer,
60VA/12V~
LI227160



Further transformer options on request.



SOLASTO



- + Cover: stainless steel 304

NEW



Socket/Lamp [excl.]:
GU10 / GU10, 6W
51mm max.

Material:
Stainless steel 304/glass/plastic

Accessories/Included:
Installation pot [incl.]

Dimensions:
 Fitting Ø/H: 12/13,6 cm
 Cover Ø/H: 12/4 cm

Fitting L/W/H: 12/12/13,6 cm
 Cover L/W/H: 12/12/4 cm

Note:
To be walked on. **Not** to be driven on.

Models:
 stainless steel
 Cover **LI227680**

Cover **LI227684**

UPGRADE:

LED GU10 4,3W, 40°
2700K, 245lm, EEC=A+
5kWh/1000h
LI551252





DASAR® 115 MR16, rigid



↑ Cover: stainless steel 316



Socket/Lamp [excl.]:
GX5,3 / \llcorner QR-CBC51, 35W max.

Lamp options [excl.]:
\llcorner QR-C51 / LED

Material:
Stainless steel 316/aluminium/glass

Accessories/Included:
Installation pot [incl.]
Transformer [excl.]

Recommended connection:
IP44 conventional transformer,
60VA/12V~
LI227160

Models:
■ stainless steel
○ Cover
□ Cover

Item no.:
LI229340
LI229344

LED UPGRADE:
LED MR16 3,8W
2700K, 225lm, EEC=A+
5kWh/1000h
LI551242

Recommended connection:
IP44 conventional transformer
150VA/12V~
LI227150

DASAR® 115 MR16, adjustable

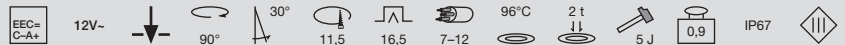

↑ Cover: stainless steel 316

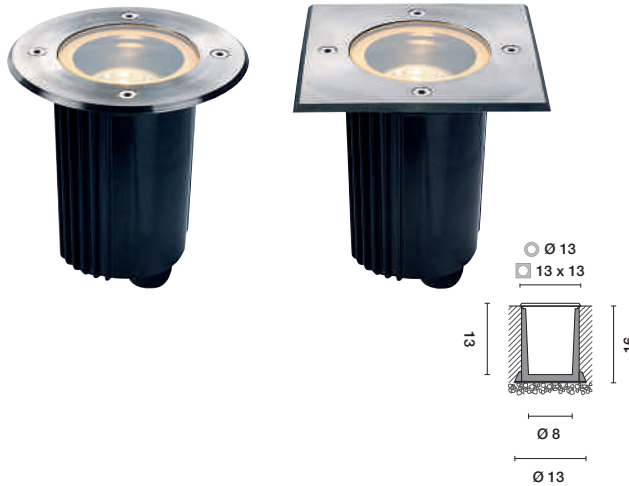

Socket/Lamp [excl.]:
GU5,3 / \llcorner QR-CBC51, 35W max.

Lamp options [excl.]:
\llcorner QR-C51 / LED

Material:
Stainless steel 316/aluminium/glass

Accessories/Included:
Installation pot [incl.]
Transformer [excl.]

Recommended connection:
IP44 conventional transformer,
60VA/12V~
LI227160

Models:
Glass partially frosted
■ stainless steel
○ Cover
□ Cover

Item no.:
LI229330
LI229334

LED UPGRADE:
LED MR16 3,8W
2700K, 225lm, EEC=A+
5kWh/1000h
LI551242

Recommended connection:
IP44 conventional transformer
150VA/12V~
LI227150

DASAR® EXACT MR16

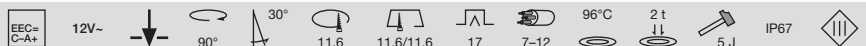

↑ Cover: stainless steel 316
↑ Installation at ground level



Socket/Lamp [excl.]:
GU5,3 / \llcorner QR-CBC51, 35W max.

Lamp options [excl.]:
\llcorner QR-C51 / LED

Material:
Stainless steel 316/aluminium/glass

Accessories/Included:
Installation pot [incl.]
Transformer [excl.]

Note:
The Dasar® Exact fitting can be installed with the cover at ground level.

Recommended connection:
IP44 conventional transformer,
60VA/12V~
LI227160

Models:
Glass partially frosted
■ stainless steel brushed
○ Cover
□ Cover

Item no.:
LI228420
LI228424

LED UPGRADE:
LED MR16 3,8W
2700K, 225lm, EEC=A+
5kWh/1000h
LI551242

Recommended connection:
IP44 conventional transformer
150VA/12V~
LI227150

When connection several fittings, please keep the total wattage in mind. Further transformer options on request. The transformers are splashwater-proof according to safety class IP44, but not suitable for underwater-application.

N-TIC PRO GU10 stainless steel



- + Housing and cover: stainless steel 316
- + Extremely resistant to corrosion

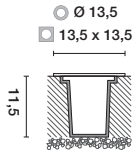

Socket/Lamp [excl.]:
GU10 / QPAR51, 35W max.
up to max. Ø/L: 5/5,7 cm

Lamp options [excl.]:
LED

Material:
Stainless steel 316/glass

Accessories/Included:
Installation pot [incl.]

Note:
The entire housing of N-tic Pro is made of **stainless steel cast 316** and thus suitable for professional application.

Models:
Glass partially frosted
■ stainless steel brushed
○ Cover
□ Cover

Item no.:
L1230910
L1230914

LED UPGRADE:
PHILIPS Corepro LED Spot 3,5W, 36°
3000K, 245lm, EEC=A+
4kWh/1000h
L1560084



ADJUST GU10

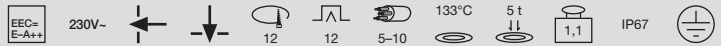

- + Cover: stainless steel 304

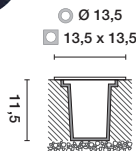

Socket/Lamp [excl.]:
GU10 / QPAR51, 35W max.
up to max. Ø/L: 5/5,7 cm

Lamp options [excl.]:
LED

Material:
Stainless steel 304/aluminium/glass

Accessories/Included:
Installation pot [incl.]

Models:
Glass partially frosted
■ stainless steel
○ Cover
□ Cover

Item no.:
L1228210
L1228214

LED UPGRADE:
PHILIPS Corepro LED Spot 3,5W, 36°
3000K, 245lm, EEC=A+
4kWh/1000h
L1560084



ADJUST QUADRO GU10

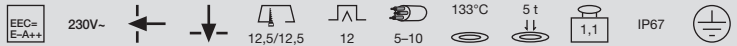

- + Cover: stainless steel 304



Socket/Lamp [excl.]:
GU10 / QPAR51, 35W max.
up to max. Ø/L: 5/6 cm

Lamp options [excl.]:
LED

Material:
Stainless steel 304/aluminium/glass

Dimensions:
L/W/H: 13/13/12 cm
Glass insert L/W: 7/7 cm

Accessories/Included:
Installation pot [incl.]

Models:
Glass partially frosted
■ stainless steel

Item no.:
L1228218

LED UPGRADE:
PHILIPS Corepro LED Spot 3,5W, 36°
3000K, 245lm, EEC=A+
4kWh/1000h
L1560084





DASAR® 115 GU10

† Cover: stainless steel 316

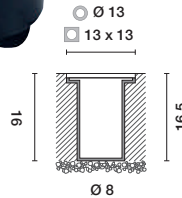
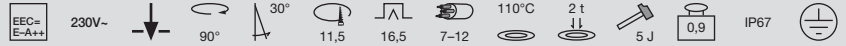

Socket/Lamp [excl.]:
GU10 / QPAR51, 35W max.
up to max. Ø/L: 5/6 cm

Lamp options [excl.]:
LED

Material:
Stainless steel 316/aluminium/glass

Accessories/Included:
Installation pot [incl.]

Models:
Glass partially frosted
■ stainless steel
○ Cover
□ Cover

Item no.:
LI229320
LI229324

LED UPGRADE:
PHILIPS Corepro LED Spot 3,5W, 36°
3000K, 245lm, EEC=A+
4kWh/1000h
LI560084



DASAR® EXACT GU10

† Cover: stainless steel 316
† Installation at ground level

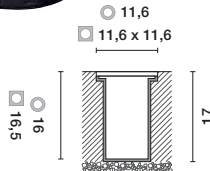

Socket/Lamp [excl.]:
GU10 / QPAR51, 35W max.
up to max. Ø/L: 5/6 cm

Lamp options [excl.]:
LED

Material:
Stainless steel 316/aluminium/glass

Accessories/Included:
Installation pot [incl.]

Note:
The Dasar® Exact fitting can be installed with the cover at ground level.

Models:
Glass partially frosted
■ stainless steel brushed
○ Cover
□ Cover

Item no.:
LI228430
LI228434

LED UPGRADE:
PHILIPS Corepro LED Spot 3,5W, 36°
3000K, 245lm, EEC=A+
4kWh/1000h
LI560084



DASAR® SQUARE GU10

† Cover: stainless steel 304

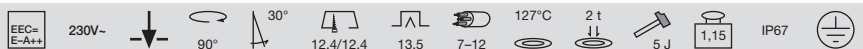

Socket/Lamp [excl.]:
GU10 / QPAR51, 35W max.
up to max. Ø/L: 5/6 cm

Lamp options [excl.]:
LED

Material:
Stainless steel 304/aluminium/glass

Dimensions:
Ø/H: 7/12 cm
Cover L/W: 13/13 cm

Accessories/Included:
Installation pot [incl.]

Models:
Glass partially frosted
■ stainless steel

Item no.:
LI229374

LED UPGRADE:
PHILIPS Corepro LED Spot 3,5W, 36°
3000K, 245lm, EEC=A+
4kWh/1000h
LI560084







ADJUST QRB111



† Cover: stainless steel 304



Socket/Lamp [excl.]:
G53 / QR111, 50W max.

Lamp options [excl.]:
LED

Material:
Stainless steel 304/aluminium/glass

Dimensions:
 ○ Ø/H: 19/13,5 cm
 □ L/W/H: 19/19/13,5 cm

Accessories/Included:
 Installation pot [incl.]
 Conventional transformer [incl.]

Models:
 Glass partially frosted
 ■ stainless steel
 ○ Cover
 □ Cover

Item no.:
 LI227090
 LI227092

LED UPGRADE:
 PowerLED 15W, 30°
 2700K, 810lm, EEC=A
 16kWh/1000h
 LI551602



DASAR® BULLSEYE QRB111



† Cover: stainless steel 316
 † To be tilted out

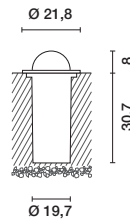

Socket/Lamp [excl.]:
G53 / QR111, 50W max.

Lamp options [excl.]:
LED

Material:
Stainless steel 316/glass/aluminium

Accessories/Included:
 Installation pot [incl.]
 Conventional transformer [incl.]

Models:
 ■ stainless steel

Item no.:
 LI228370

LED UPGRADE:
 PowerLED 15W, 30°
 2700K, 810lm, EEC=A
 16kWh/1000h
 LI551602



DASAR® ES111



† Cover: stainless steel 316



Socket/Lamp [excl.]:
GU10 / QPAR111, 75W max.

Lamp options [excl.]:
LED

Material:
Stainless steel 316/aluminium/glass

Dimensions:
 ○ Ø/H: 21,5/16 cm
 □ L/W/H: 21,5/21,5/16 cm

Accessories/Included:
 Installation pot [incl.]
 Diffuser insert [excl.]

Models:
 ■ stainless steel
 ○ Cover
 □ Cover

Item no.:
 LI229230
 LI229234

LED UPGRADE:
 LED ES111, 17,5W, 30°
 dimmable
 2700K, 880lm, EEC=A
 18kWh/1000h
 LI551642





DASAR® 260 UNI

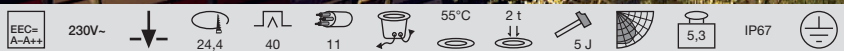

± Cover: stainless steel 316



Socket/Lamp [excl.]:
E27 / TC(...)SE, 24W max.
up to max. Ø/L: 5,2/17,3 cm

Lamp options [excl.]:
LED

Material:
Stainless steel 316/aluminium/glass

Dimensions:
○ Ø/H: 27/31,5 cm
□ L/W/H: 27/27/31,5 cm

Accessories/Included:
Installation pot [incl.]

Models:
■ stainless steel
○ Cover
□ Cover

Item no.:
L1229210
L1229214

Recommended lamp:
11W, 2700K, 600lm, EEC=A
11kWh/1000h
L1508211



DASAR® 215 UNI



± Cover: stainless steel 316



Socket/Lamp [excl.]:
E27 / TC(...)SE, 11W max.
up to max. Ø/L: 4,5/13,4 cm

Lamp options [excl.]:
◀ PAR30 / ▶ PAR38 / ▶ QPAR30 /
◀ QPAR38 / ▶ TCPAR30-SE /
◀ TCPAR38-SE / LED

Material:
Stainless steel 316/aluminium/glass

Dimensions:
○ Ø/H: 21,5/22,5 cm
□ L/W/H: 21,5/21,5/22,5 cm

Accessories/Included:
Installation pot [incl.]
Diffuser insert [excl.]

Models:
■ stainless steel
○ Cover
□ Cover

Item no.:
L1229200
L1229204

Recommended lamp:
11W, 2700K, 600lm, EEC=A
11kWh/1000h
L1508211



***Surface temperature:**
EnergySaver = 48°C
PAR30 = 119°C
PAR38 = 108°C



DASAR® T5-14

EEC=A-A+ 230V~ Ballast EE=E2 68/12,5 11 7-12 30°C 2 t 90° 5,7 IP67

- + Cover: stainless steel 316
- + High-efficient lamp

Socket/Lamp [excl.]:
G5 / — T16, 14W

Models:
■ stainless steel

Item no.:
LI230100

Material:
Stainless steel 316/aluminium/glass

Dimensions:
L/W/H: 70/12/9,7 cm
Cover L/W: 70/12 cm

Recommended lamp:
14W, 3000K, 1200lm, EEC=A+
16kWh/1000h
LI548014

Accessories/Included:
Inground profile [incl.]
Electronic ballast [incl.]

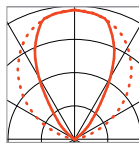
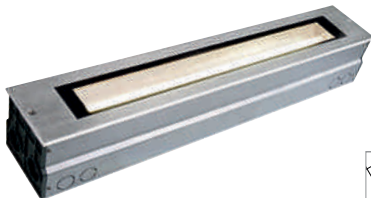

DASAR® T5-21

EEC=A-A+ 230V~ Ballast EE=E2 98/12,5 11 7-12 30°C 2 t 90° 8,3 IP67

- + Cover: stainless steel 316
- + High-efficient lamp

Socket/Lamp [excl.]:
G5 / — T16, 21W

Models:
■ stainless steel

Item no.:
LI230110

Material:
Stainless steel 316/aluminium/glass

Dimensions:
L/W/H: 100/12/9,7 cm
Cover L/W: 100/12 cm

Recommended lamp:
21W, 3000K, 1900lm, EEC=A+
23kWh/1000h
LI548021

Accessories/Included:
Inground profile [incl.]
Electronic ballast [incl.]

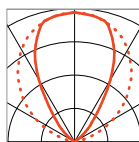



DASAR® LED SQUARE
asymmetrical

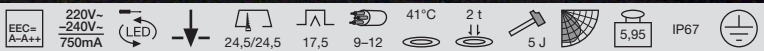

- ✦ Cover: stainless steel 316
- ✦ For professional application
- ✦ Low installation depth
- ✦ Asymmetrical reflector



Lamp [incl.]:

PHILIPS
SLM LED Module, 28W
Total consumption: 34W

Models:

■ stainless steel
4000K, 1620lm, CRI>80

Item no.:

L1229381

3000K, 1620lm, CRI 80 **L1229383**

Material:

Stainless steel 316/aluminium/glass

Dimensions:

L/W/H: 25,5/25,5/14,5 cm

Accessories/Included:

LED driver [incl.]
Installation pot [incl.]

Note:

Asymmetrical reflector

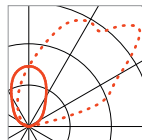

DASAR® HQI SQUARE 70W
asymmetrical



- ✦ Cover: stainless steel 316
- ✦ For professional application
- ✦ Low installation depth
- ✦ Asymmetrical reflector



Socket/Lamp [excl.]:

Rx7s / HIT-DE, 70W

Models:

■ stainless steel

Item no.:

L1229294

Material:

Stainless steel 316/aluminium/glass

Dimensions:

L/W/H: 25,5/25,5/15,5 cm

Accessories/Included:

Installation pot [incl.]
Conventional ballast [incl.]

Note:

Asymmetrical reflector

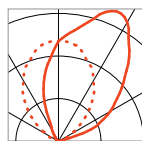

Recommended lamp:

PHILIPS 70W,
4200K, 5600lm, EEC=A
78kWh/1000h
L150701





ADJUST HIT 70

EEC=A-A+ 230V~ Ballast EEL=A3 26 22 15° 12 101°C 5 t IP67

† Cover: stainless steel 304



Socket/Lamp [excl.]:
G12 / HIT-CE, 70W

Material:
Stainless steel 304/aluminium/glass

Dimensions:
 ○ Ø/H: 26,5/20 cm
 □ L/W/H: 26,5/26,5/20 cm

Accessories/Included:
 Installation pot [incl.]
 Conventional ballast [incl.]

Models:
 ■ stainless steel
 ○ Cover
 □ Cover

Item no.:
 LI228240
 LI228244

Recommended lamp:
PHILIPS 70W,
 3000K, 6600lm, EEC=A
 80kWh/1000h
 LI507130



Recommended lamp:
PHILIPS 70W,
 3000K, 7500lm, EEC=A+
 80kWh/1000h
 LI507430



DASAR® HIT-T 70W

EEC=A-A+ 230V~ Ballast EEL=A3 24,4 40 25° 12 120°C 2 t IP67

† Cover: stainless steel 316
 † For professional application



Socket/Lamp [excl.]:
G12 / HIT-CE, 70W

Material:
Stainless steel 316/aluminium/glass

Dimensions:
 ○ Ø/H: 26/30 cm
 □ L/W/H: 27/27/32 cm

Accessories/Included:
 Installation pot [incl.]
 Conventional ballast [incl.]

Models:
 ■ stainless steel
 ○ Cover
 □ Cover

Item no.:
 LI229270
 LI229274

Recommended lamp:
PHILIPS 70W,
 3000K, 6600lm, EEC=A
 80kWh/1000h
 LI507130



Recommended lamp:
PHILIPS 70W,
 3000K, 7500lm, EEC=A+
 80kWh/1000h
 LI507430





LED PROFILES



Applications: Diverse

Whether you are looking for functional solutions for stairway lighting, want to set interior lighting accents, or need an individual profile solution – our portfolio of LED profiles opens a broad range of possibilities, and sets your imagination free.



Quality: Premium

What makes our LED profiles so outstanding are their high-end materials, durable drivers, energy saving LED strips and – as with all of the products in this catalogue – their "German engineering." And we gave quite a bit of thought to some other things as well – you can find recommendations for putting together all the right accessories for our profiles on the following pages.





 **Fully assembled LED Profiles:
Sheer comfort**

We don't just want to offer you a wide range of LED profiles, we also want to make your life easier. How is that supposed to work? Simple: You tell us what your ideal solution would be, and give us the dimensions. We cut the profile to your exact measurements, put together the right components, and deliver the finished LED profile assembly to your doorstep.



LIGHT BARS
PAGE 744



FUNCTIONAL
PROFILE SOLUTIONS
PAGE 746



PROFESSIONAL
PROFILE SOLUTIONS
PAGE 756





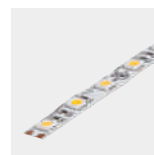





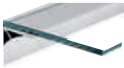





DECORATIVE
PROFILE SOLUTIONS
PAGE 768







LED STRIPS
PAGE 774

ALL SLV PROFILES AT A GLANCE

FUNCTIONAL PROFILES		Installation			
		Recessed	Partially recessed	Surface-mounted	Pendant
	GLENOS Shelf profile 60 / 100 / 200			X	
	GLENOS Corner profile 100 / 200			X	
	GLENOS Wall recessed profile asymmetrical 4026			X	
	GLENOS Baseboard 100 / 200			X	
	GLENOS Step profile UP 100 / 200			X	
	GLENOS Step profile DOWN 100 / 200			X	
	GLENOS Wall profile 2330-200			X	
	GLENOS Wall profile UP / DOWN 200			X	

PROFESSIONAL PROFILES		Installation			
		Recessed	Partially recessed	Surface-mounted	Pendant
	GLENOS Professional wall mounting bracket profile 20 / 100			X	
	GLENOS Professional profile 2020-100 / 2020-200	X	X	X	
	GLENOS Professional profile 2609-100 / 2609-200 / 2609-300	X	X	X	
	GLENOS Professional profile 3030-100 / 3030-200 / 3030-300	X	X	X	X
	GLENOS Professional profile 4970-100 / 4970-200	X	X	X	X
	GLENOS Professional recessed profile 8832-100 / 8832-200	X			

DECORATIVE PROFILES		Installation			
		Recessed	Partially recessed	Surface-mounted	Pendant
	GLENOS Linear profile 1809-100 / 1809-200	X		X	
	GLENOS Linear profile 1107-100 / 1107-200	X		X	
	GLENOS Linear profile 1612-100	X		X	
	GLENOS Linear recessed profile 2212-100	X			
	GLENOS Linear recessed profile 2508-100 / 2508-200	X			



Section	Beam angle	Item no.	Page
		LI13534 / LI213544 / LI213554 / LI213531 / LI213541 / LI213551	746
		LI213904 / LI213914 / LI213901 / LI213911	748
		LI213401 / LI213404	750
		LI214004 / LI214014 / LI214000 / LI214010 / LI214011	751
		LI213581 / LI213582	752
		LI213591 / LI213592	753
		LI213312	754
		LI213352	755



Section	Beam angle	Item no.	Page
		LI213664 / LI213674 / LI213660 / LI213661	756
		LI213430 / LI213440 / LI213450 / LI213431 / LI213441 / LI213434 / LI213444 / LI213451 / LI213454 / LI213459	758
		LI213700 / LI213710 / LI213720 / LI213701 / LI213711 / LI213721 / LI213704 / LI213714 / LI213724	760 / 761
		LI213610 / LI213620 / LI213630 / LI213611 / LI213621 / LI213631 / LI213614 / LI213624 / LI213634	762
		LI213461 / LI213471 / LI213464 / LI213474	764
		LI213501 / LI213511 / LI213504 / LI213514	766



Section	Beam angle	Item no.	Page
		LI213804 / LI213814 / LI213800 / LI213810 / LI213801 / LI213811	768
		LI213944 / LI213954 / LI213940 / LI213950 / LI213941 / LI213951	770
		LI213342	771
		LI213332	772
		LI213861 / LI213862	773





PADI LED 600 Light bar



Decorative basic lighting | Profile with already built-in LED strip, for easy installation with installation clips

Description	LED colour	Wattage [W]	LED distance [cm]	LEDs per bar	Luminous flux	Colour rendering	Dimensions [cm]	Weight [kg]	Item no.	Recomm. power supply
Padi LED 600 Light Bar	3000K	4	1	48	360lm	CRI>80	60,6 / 1,6 / 0,8	0,12	LI111732	LI470502
	4000K	4	1	48	370lm	CRI>80	60,6 / 1,6 / 0,8	0,12	LI111730	LI470502

Please keep the total wattage in mind when connection several light bars | Installation clips (3 pcs., stainless steel) incl. | Further power supplies in the Accessories chapter



DELFC PRO Light bar

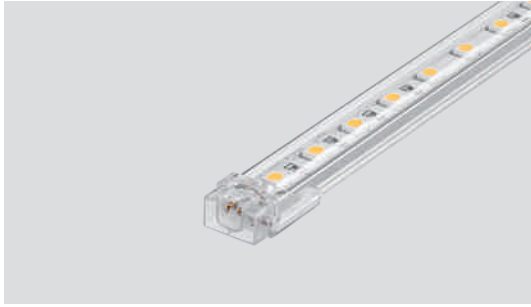

Recommended accessory



Feed-in cable 50W



Flex connector 50W



Installation clips



Installation clips 45° angle

Description	Item no.
Feed-in cable (50W max., cable L: 1,5 m)	LI631470
Flex connector (50W max., cable L: 12 cm)	LI631471
Installation clips (10 pcs.)	LI631472
Installation clips 45° angle (10 pcs., stainless steel)	LI631475

 Decorative basic lighting | Profile with already built-in LED strip, for easy installation with installation clips

Description	LED colour	Wattage [W]	LED distance [cm]	LEDs per bar	Luminous flux	Colour rendering	Dimensions [cm]	Weight [kg]	Item no.	Recomm. power supply
Delf C 100 Pro	3000K	1,2	1,1	6	80lm	CRI>80	10,0 / 2,0 / 1,5	0,02	LI631432	LI470502
Delf C 200 Pro	3000K	2,1	1,1	12	150lm	CRI>80	20,0 / 2,0 / 1,5	0,04	LI631442	LI470502
Delf C 500 Pro	3000K	4,9	1,1	30	450lm	CRI>80	50,0 / 2,0 / 1,5	0,12	LI631452	LI470502
Delf C 500 Pro	5700K	4,9	1,1	30	450lm	CRI>80	50,0 / 2,0 / 1,5	0,12	LI631451	LI470502
Delf C 1000 Pro	3000K	11,6	1,1	60	900lm	CRI>80	100,0 / 2,0 / 1,5	0,23	LI631462	LI470502
Delf C 1000 Pro	5700K	11,6	1,1	60	900lm	CRI>80	100,0 / 2,0 / 1,5	0,23	LI631461	LI470502
Delf C 1200 Pro	3000K	12,5	1,1	72	1050lm	CRI>80	120,0 / 2,0 / 1,5	0,24	LI631482	LI470542

Please keep the total wattage in mind when connection several light bars | Further power supplies in the Accessories chapter

DELFC PRO RGB Light bar



Recommended accessory



Feed-in cable 50W



Flex connector 50W

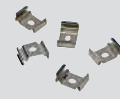

Installation clips



Installation clips 45° angle

Description	Item no.
Feed-in cable (50W max., cable L: 1,5 m)	LI631473
Flex connector (50W max., cable L: 12 cm)	LI631474
Installation clips (10 pcs.)	LI631472
Installation clips 45° angle (stainless steel, 10 pcs.)	LI631475

 Decorative basic lighting | Profile with already built-in LED strip, for easy installation with installation clips

Description	LED colour	Wattage [W]	LED distance [cm]	LEDs per bar	Dimensions [cm]	Weight [kg]	Item no.	Recomm. power supply
Delf C 500 RGB Pro	RGB	7,5	1,1	30	50 / 2,0 / 1,5	0,12	LI631453	LI470581
Delf C 1000 RGB Pro	RGB	14,6	1,1	60	100 / 2,0 / 1,5	0,23	LI631463	LI470581

Please keep the total wattage in mind when connection several light bars | Further power supplies in the Accessories chapter

Control components



Power LIM²2 RGB Master controller



Power LIM²2 RGB Slave controller



Remote control for Power LIM²2 Master controller

Description	Item no.
Power LIM²2 RGB Master controller (60W max., 24V=, built-in power supply 60W incl.)	LI470581
Power LIM²2 RGB Slave controller (60W max., 24V=, built-in power supply 60W incl.)	LI470582
Remote control for Power LIM²2 Master controller (IR receiver incl.)	LI470520

Further information in the Accessories chapter



 **GLENOS Shelf profile 60**

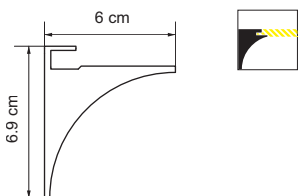

Recommended accessory



GLENOS
End caps for shelf profile

Description	Dimensions [cm]	Colour	Item no.
<input type="checkbox"/> GLENOS End caps for shelf profile	6,9 / 6,0 / 0,14	white matt	LI213571
<input type="checkbox"/> (2 pcs., each 1 x right and left, plastic)		silver	LI213574



For installation of glass plates, thickness 0,8 cm, with LED strip fixed underneath | Light effect through refraction in glass

Description	Installation		Length [cm]	Weight [kg]	Colour	Item no.	Recommendation	
	Surface-mounted	Recessed					LED strip	power supply
<input type="checkbox"/> <input type="checkbox"/> GLENOS shelf profile 60	X		60	0,76	white matt alu anodised	LI213531 LI213534	LI552402/03/05 LI552532/33/35	LI470502 LI470502
Max. width LED strip 10 mm Mounting with 3 counter-sunk screws Glass plate thickness exactly 0,8 cm to plug into the profile Max. width 18 cm Max. load 10 kg								



GLENOS Shelf profile 100

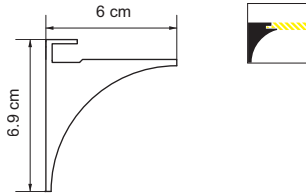
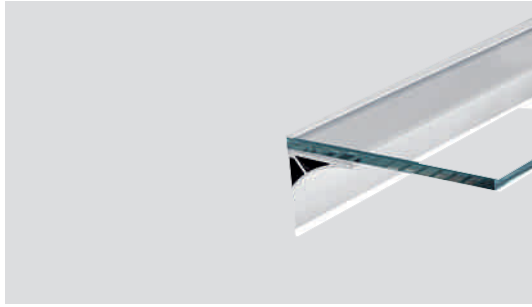

Recommended accessory



GLENOS
End caps for shelf profile

Description	Dimensions [cm]	Colour	Item no.
<input type="checkbox"/> GLENOS End caps for shelf profile	6,9 / 6,0 / 0,14	white matt	LI213571
<input type="checkbox"/> (2 pcs., each 1 x right and left, plastic)		silver	LI213574



For installation of glass plates, thickness 0,8 cm, with LED strip fixed underneath | Light effect through refraction in glass

Description	Installation		Length [cm]	Weight [kg]	Colour	Item no.	Recommendation	
	Surface-mounted	Recessed					LED strip	power supply
<input type="checkbox"/> GLENOS Shelf profile 100	X		100	1,26	white matt	LI213541	LI552402/03/05	LI470502
<input type="checkbox"/>					alu anodised	LI213544	LI552532/33/35	LI470502
Max. width LED strip 10 mm Mounting with 4 counter-sunk screws Glass plate thickness exactly 0,8 cm to plug into the profile Max. width 18 cm Max. load 10 kg								

GLENOS Shelf profile 200

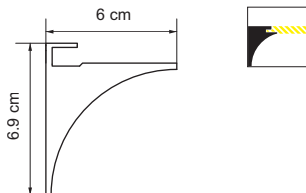
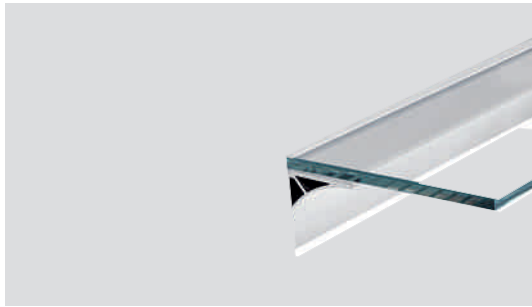

Recommended accessory



GLENOS
End caps for shelf profile

Description	Dimensions [cm]	colour	Item no.
<input type="checkbox"/> GLENOS End caps for shelf profile	6,9 / 6,0 / 0,14	white matt	LI213571
<input type="checkbox"/> (2 pcs., each 1 x right and left, plastic)		silver	LI213574



For installation of glass plates, thickness 0,8 cm, with LED strip fixed underneath | Light effect through refraction in glass

Description	Installation		Length [cm]	Weight [kg]	Colour	Item no.	Recommendation	
	Surface-mounted	Recessed					LED strip	power supply
<input type="checkbox"/> GLENOS Shelf profile 200	X		200	2,53	white matt	LI213551	LI552412/13/15	LI470502
<input type="checkbox"/>					alu anodised	LI213554	LI552542/43/45	LI470544
Max. width LED strip 10 mm Mounting with 8 counter-sunk screws Glass plate thickness exactly 0,8 cm to plug into the profile Max. width 18 cm Max. load 10 kg								



GLENOS Corner profile 100

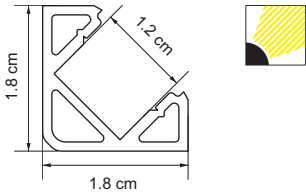

Recommended accessory



GLENOS
Cover 1 m for
corner profile 100



GLENOS
End caps for corner profile



GLENOS
Installation spring for
corner profile

	Description	Dimensions [cm]	Colour	Item no.
<input type="checkbox"/>	GLENOS cover 100 for corner profile 100 (plastic)	100	white	LI213821
<input type="checkbox"/>	GLENOS end caps for corner profile (2 pcs., plastic)	2,6 / 1,8	white matt silver-grey	LI213931 LI213934
<input type="checkbox"/>	GLENOS installation spring for corner profile (2 pcs., stainless steel)	2,4 / 2,1 / 2,0	stainless steel	LI213939

+ Ideal for installation in corners or on ceilings, for installation under cabinets or application in booth construction

Description	Installation		Length [cm]	Weight [kg]	Colour	Item no.	Recomm.	
	Surface-mounted	Recessed					LED strip	power supply
<input type="checkbox"/> GLENOS Corner profile 100	X		100	0,27	white matt	LI213901	LI552532/33/35	LI470502
					alu anodised	LI213904	LI552472/73/75	LI470544
							LI552402/03/05	LI470502
							LI552532/33/35	LI470502

Mounting with installation springs | Max. width LED strip 10 mm | Cover excl.

GLENOS Corner profile 200

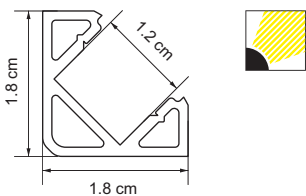

Recommended accessory



GLENOS
Cover 2 m for
corner profile 200



GLENOS
End caps for corner profile



GLENOS
Installation spring for
corner profile

	Description	Dimensions [cm]	Colour	Item no.
<input type="checkbox"/>	GLENOS cover 200 for corner profile 200 (plastic)	200	white	LI213822
<input type="checkbox"/>	GLENOS end caps for corner profile (2 pcs., plastic)	2,6 / 1,8	white matt silver-grey	LI213931 LI213934
<input type="checkbox"/>	GLENOS installation spring for corner profile (2 pcs., stainless steel)	2,4 / 2,1 / 2,0	stainless steel	LI213939

+ Ideal for installation in corners or on ceilings, for installation under cabinets or application in booth construction

Description	Installation		Length [cm]	Weight [kg]	Colour	Item no.	Recomm.	
	Surface-mounted	Recessed					LED strip	power supply
<input type="checkbox"/> GLENOS Corner profile 200	X		200	0,54	white matt	LI213911	LI552442/43/45	LI470544
					alu anodised	LI213914	LI552542/43/45	LI470544

Mounting with installation springs | Max. width LED strip 10 mm | Cover excl.





 **GLENOS** Wall recessed profile asymmetrical 4026-200

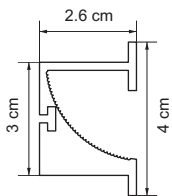
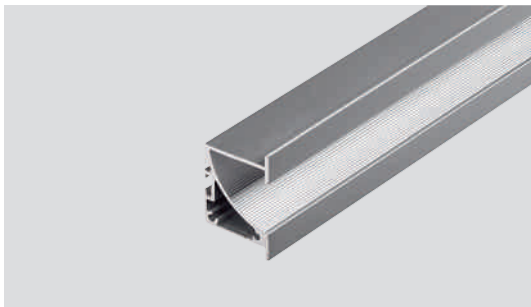

Recommended accessory



GLENOS
End caps set for
alu wall profile
4026-200 (2 pcs.)



GLENOS
Installation spring
and accessories,
4026-200 (5 pcs.)



GLENOS
Connector for
alu wall recessed profile
4026-200

Description	Dimensions [cm]	Colour	Item no.
<input type="checkbox"/> GLENOS end caps set for alu wall profile 4026-200 (2 pcs. each 1 x right and left, plastic)	1,0 / 4,0 / 2,6	white matt	LI213411
<input type="checkbox"/> GLENOS end caps set for alu wall profile 4026-200 (2 pcs. each 1 x right and left, plastic)		silver-grey	LI213414
<input type="checkbox"/> GLENOS installation spring and accessories, 4026-200 (5 pcs., steel)	4,3 / 3,0 / 1,0	chrome	LI213421
<input type="checkbox"/> GLENOS connector for alu wall recessed profile 4026-200 (1 pce., steel)	6,0 / 0,15 / 0,75	chrome	LI213422



For accent lighting on walls | Indirect illumination through the downwards-directed LED strip | Light points not visible

Description	Installation			Length [cm]	Weight [kg]	Colour	Item no.	Recommendation		
	Surface-mounted	Recessed						LED strip	power supply	feed-in cable
<input type="checkbox"/> GLENOS Wall recessed profile asymmetrical 4026-200		X		200	1,12	white matt	LI213401	LI552542/43/45	LI470544	LI550412
						silver-grey	LI213404	LI552482/83/85	LI470506	LI550413
								LI552442/43/45	LI470544	LI550413
								LI552542/43/45	LI470544	LI550412

Mounting with installation springs | For installation of flexible LED strips with a max. width of 18 mm | Installation depth with installation spring 3,5 cm



GLENOS Baseboard 100

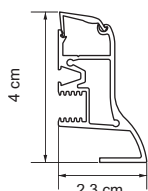

Recommended accessory



GLENOS Inner connector for Baseboard 90°



GLENOS Outer connector for Baseboard 90°



GLENOS End caps for Baseboard



GLENOS Plugs for Baseboard 100

Description	Dimensions [cm]	Colour	Item no.
GLENOS Inner connector for Baseboard 90° (plastic)	3,4 / 4,2	black matt	LI214040
		white matt	LI214041
		silver-grey	LI214044
GLENOS Outer connector for Baseboard 90° (plastic)	3,4 / 4,1	black matt	LI214050
		white matt	LI214051
		silver-grey	LI214054
GLENOS End caps for Baseboard (2 pcs., plastic)	2,5 / 4,2	black matt	LI214060
		white matt	LI214061
		silver-grey	LI214064
GLENOS Plugs for Baseboard 100 (2 pcs., plastic, for brickwork)	3,7	blue	LI214068

Special light effect on the wall

Description	Installation		Length [cm]	Weight [kg]	Colour	Item no.	Recommendation	
	Surface-mounted	Recessed					LED strip	power supply
GLENOS Baseboard 100 incl. cover	X		100	0,47	black matt	LI214000	LI552432/33/35	LI470502
					white matt	LI214001	LI552532/33/35	LI470502
					alu anodised	LI214004	LI552402/03/05	LI470502
Max. width LED strip 12 mm Plugs suitable for mounting on brickwork (Ø drill hole 6 mm) For mounting on dry walls we recommend hybrid-polymer-based glue							LI552532/33/35	LI470502

GLENOS Baseboard 200

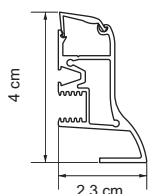
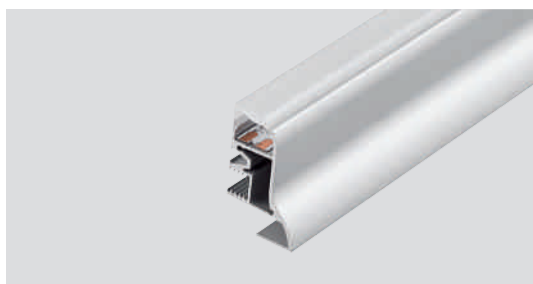

Recommended accessory



GLENOS Inner connector for Baseboard 90°



GLENOS Outer connector for Baseboard 90°



GLENOS End caps for Baseboard



GLENOS Plugs for Baseboard 200

Description	Dimensions [cm]	Colour	Item no.
GLENOS Inner connector for Baseboard 90° (plastic)	3,4 / 4,2	black matt	LI214040
		white matt	LI214041
		silver-grey	LI214044
GLENOS Outer connector for Baseboard 90° (plastic)	3,4 / 4,1	black matt	LI214050
		white matt	LI214051
		silver-grey	LI214054
GLENOS End caps for Baseboard (2 pcs., plastic)	2,5 / 4,2	black matt	LI214060
		white matt	LI214061
		silver-grey	LI214064
GLENOS Plugs for Baseboard 200 (2 pcs., plastic, for brickwork)	3,7	blue	LI214068

Special light effect on the wall

Description	Installation		Length [cm]	Weight [kg]	colour	Item no.	Recomm.	
	Surface-mounted	Recessed					LED strip	power supply
GLENOS Baseboard 200 incl. cover	X		200	0,94	black matt	LI214010	LI552542/43/45	LI470544
					white matt	LI214011	LI552482/83/85	LI470506
					alu anodised	LI214014	LI552442/43/45	LI470544
Max. width LED strip 12 mm Plugs suitable for mounting on brickwork (Ø drill hole 6 mm) For mounting on dry walls we recommend hybrid-polymer-based glue							LI552482/83/85	LI470506
							LI552542/43/45	LI470544



 **GLENOS Step profile UP 100 / 200**

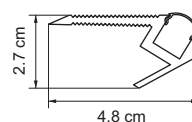

Turns stairs into a special eye-catcher and makes for orientation and a safe step

Description	Installation		Length [cm]	Weight [kg]	Colour	Item no.
	Surface-mounted	Recessed				
■ GLENOS Step profile UP 100 incl. cover	X		100	0,59	alu anodised	LI213581
Max. width LED strip 9,8 mm Illumination: upwards						

Recommendation	
LED strip	power supply
LI552602/03/04	LI470502
LI552502/03/05	LI470502

Description	Installation		Length [cm]	Weight [kg]	Colour	Item no.
	Surface-mounted	Recessed				
■ GLENOS Step profile UP 200 incl. cover	X		200	1,18	alu anodised	LI213582
Max. width LED strip 9,8 mm Illumination: upwards						

Recommendation	
LED strip	power supply
LI552612/13/14	LI470542
LI552512/13/15	LI470542



GLENOS Step profile DOWN 100

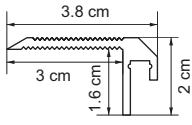

Recommended accessory



GLENOS Cover 100 for step profile DOWN 100



GLENOS End caps for step profile DOWN

	Description	Dimensions [cm]	Colour	Item no.
<input type="checkbox"/>	GLENOS Cover 100 for step profile DOWN 100	100	white	LI213594
<input checked="" type="checkbox"/>	GLENOS End caps for step profile DOWN (2 pcs., left and right, aluminium)	3,9 / 2,0	silver-grey	LI213599

+ Turns stairs into a special eye-catcher and makes for orientation and a safe step

Description	Installation		Length [cm]	Weight [kg]	Colour	Item no.	Recommendation	
	Surface-mounted	Recessed					LED strip	power supply
<input checked="" type="checkbox"/> GLENOS Step profile DOWN 100	X		100	0,32	alu anodised	LI213591	LI552602/03/04	LI470502
Max. width LED strip 4,8 mm Illumination: downwards								

GLENOS Step profile DOWN 200

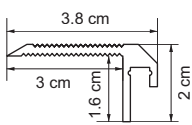

Recommended accessory



GLENOS Cover 200 for step profile DOWN 200



GLENOS End caps for step profile DOWN

	Description	Dimensions [cm]	Colour	Item no.
<input type="checkbox"/>	GLENOS Cover 200 for step profile DOWN 200	200	white	LI213595
<input checked="" type="checkbox"/>	GLENOS End caps for step profile DOWN (2 pcs., left and right, aluminium)	3,9 / 2,0	silver-grey	LI213599

+ Turns stairs into a special eye-catcher and makes for orientation and a safe step

Description	Installation		Length [cm]	Weight [kg]	Colour	Item no.	Recommendation	
	Surface-mounted	Recessed					LED strip	power supply
<input checked="" type="checkbox"/> GLENOS Step profile DOWN 200	X		200	0,64	alu anodised	LI213592	LI552612/13/14	LI470502
Max. width LED strip 4,8 mm Illumination: downwards								



 **GLENOS** Wall profile 2330-200

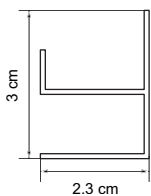

Recommended accessory



GLENOS
Installation holder for
wall profile 2330-200



GLENOS
End caps for wall profile 2330-200,
right and left

Description	Dimensions [cm]	Colour	Item no.
-------------	-----------------	--------	----------

<ul style="list-style-type: none"> GLENOS Installation holder for wall profile 2330-200 (3 pcs., aluminium, incl. screws and plugs) 	4,0 / 0,8 / 1,1	alu anodised	LI213320
--	-----------------	--------------	----------

<ul style="list-style-type: none"> GLENOS End caps for wall profile 2330-200 (2 pcs., left and right, plastic) 	2,3 / 3,0	silver-grey	LI213321
---	-----------	-------------	----------



Indirect illumination

Description	Installation			Length [cm]	Weight [kg]	Colour	Item no.	Recommendation		
	Surface-mounted	Recessed						LED strip	power supply	feed-in cable
<ul style="list-style-type: none"> GLENOS Wall profile 2330-200 	X			200	0,58	alu anodised	LI213312	LI552412/13/15	LI470502	LI550412
Mounting with installation holders Max. width LED strip 1,9 cm								LI552542/43/45	LI470506	LI550412



 **GLENOS** Wall profile UP / DOWN 200

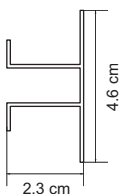
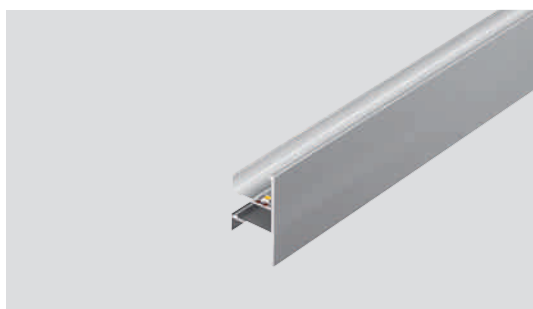

Recommended accessory



GLENOS
Installation holder for
wall profile UP / DOWN 200



GLENOS
End caps for
wall profile UP / DOWN 200

Description	Dimensions [cm]	Colour	Item no.
<ul style="list-style-type: none"> GLENOS Installation holder for wall profile UP / DOWN 200 (3 pcs., aluminium) 	4,0 / 0,8 / 1,1	alu anodised	LI213320
<ul style="list-style-type: none"> GLENOS End caps for wall profile UP / DOWN 200 (2 pcs., left and right, plastic) 	0,2 / 2,3 / 4,6	silver-grey	LI213361

 Indirect illumination up/down

Description	Installation		Length [cm]	Weight [kg]	Colour	Item no.	Recommendation		
	Surface-mounted	Recessed					LED strip	power supply	feed-in cable
<ul style="list-style-type: none"> GLENOS Wall profile UP / DOWN 200 	X		200	0,73	alu anodised	LI213352	LI552542/43/45 (x2)	LI470506	LI550412 (x2)
Mounting with installation holders Max. width LED strip 1,9 cm For up/down effect equip with 2 strips							LI552482/83/85 (x2)	LI470500	LI550413 (x2)



GLENOS Professional wall mounting bracket profile 20

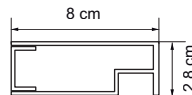

To house profiles | For surface-mounting a display light | Illumination optionally up- or downwards-directed

Description	Installation		Length	Weight [kg]	Colour	Item no.
	Surface-mounted	Recessed				
 GLENOS Professional wall mounting bracket profile 20 incl. end caps	X		20	0,25	black	LI213660
					white matt	LI213661
					alu anodised	LI213664

Max. dimensions ballast: 45 x 23 mm (WxH) | Suitable for profiles: LI213430 / LI213440 / LI213431 / LI213441 / LI213434 / LI213444 – please note the instructions regarding installation and equipment

Recommendation for items 213660/61/64		
LED strip	power supply	feed-in cable
LI552532/33/35	LI470502	LI550412
LI552472/73/75	LI470502	LI550413
LI552402/03/05	LI470502	LI550412
LI552532/33/35	LI470502	LI550412
LI552432/33/35	LI470502	LI550412
LI552532/33/35	LI470502	LI550412

Only for LED strips of max. 20 cm (if used without profile insert)

GLENOS Professional wall mounting bracket profile 100

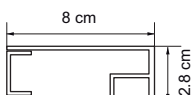

To house profiles | Illumination optionally up- or downwards-directed

Description	Installation		Length [cm]	Weight [kg]	Colour	Item no.
	Surface-mounted	Recessed				
 GLENOS Professional wall mounting bracket profile 100, incl. end caps	X		100	1,23	alu anodised	LI213674

Max. dimensions ballast: 45 x 23 mm (WxH) | Suitable for profiles: LI213430 / LI213440 / LI213431 / LI213441 / LI213434 / LI213444 – please note the instructions regarding installation and equipment

Recommendation		
LED strip	power supply	feed-in cable
LI552432/33/35	LI470502	LI550413
LI552532/33/35	LI470502	LI550412

Only for LED strips of max. 100 cm (if used without profile insert)





GLENOS Professional profile 2020-100

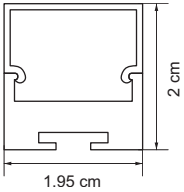
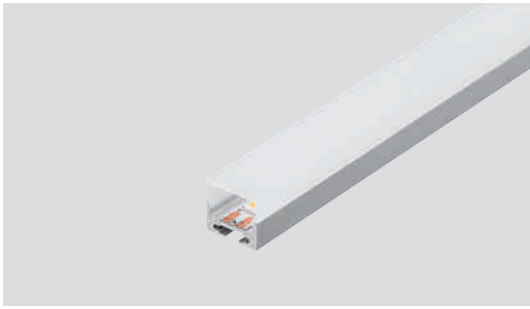

Recommended accessory

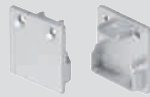

GLENOS End caps for professional profile 2020



GLENOS Long connector for professional profile 2020

Description	Dimensions [cm]	Colour	Item no.
GLENOS End caps for professional profile 2020 (2 end caps, aluminium; 4 mounting screws)	2,0 / 0,2 / 2,0	black	LI213450
		white	LI213451
		silver	LI213454
GLENOS Long connector for professional profile 2020 (aluminium)	20,0 / 1,3 / 0,254	alu anodised	LI213459
Profile for building a lamp – suits the GLENOS professional wall mounting bracket profile 2020-100/200 Booth and store construction Furniture Technical lighting			

Description	Installation		Length [cm]	Weight [kg]	Colour	Item no.
	Surface-mounted	Recessed				
GLENOS Professional profile 2020-100	X	X	100	0,28	black	LI213430
					white/white	LI213431
					alu anodised/white	LI213434
Price incl. cover Max. width LED strip 16 mm						

Recommendation		
LED strip	power supply	feed-in cable
LI552402/03/05	LI470502	LI550412
LI552532/33/35	LI470502	LI550412
LI552532/33/35	LI470502	LI550412
LI552427/73/75	LI470544	LI550413
LI552532/33/35	LI470502	LI550412
LI552432/33/35	LI470502	LI550412

GLENOS Professional profile 2020-200

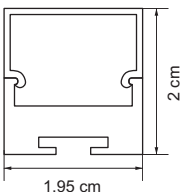
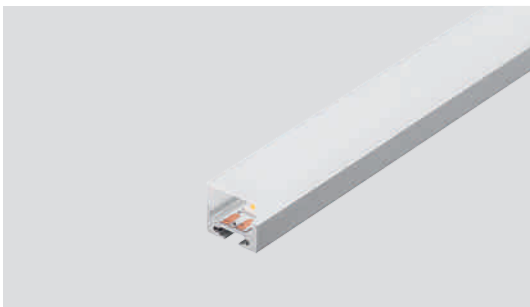

Recommended accessory



GLENOS End caps for professional profile 2020



GLENOS Long connector for professional profile 2020

Description	Dimensions [cm]	colour	Item no.
GLENOS End caps for professional profile 2020 (2 end caps, aluminium; 4 mounting screws)	2,0 / 0,2 / 2,0	black	LI213450
		white	LI213451
		silver	LI213454
GLENOS Long connector for professional profile 2020	20,0 / 1,3 / 0,254	alu anodised	LI213459
Profile for building a lamp – suits the GLENOS professional wall mounting bracket profile 2020-100/200 Booth and store construction Furniture Technical lighting			

Description	Installation		Length [cm]	Weight [kg]	Colour	Item no.
	Surface-mounted	Recessed				
GLENOS Professional profile 2020-200	X	X	200	0,56	black	LI213440
					white/white	LI213441
					alu anodised/white	LI213444
Price incl. cover Max. width LED strip 16 mm						

Recommendation		
LED strip	power supply	feed-in cable
LI552442/43/45	LI470544	LI550413
LI552542/43/45	LI470544	LI550412
LI552412/13/15	LI470502	LI550412
LI552542/43/45	LI470544	LI550412
LI552482/83/85	LI470506	LI550413
LI552542/43/45	LI470544	LI550412



GLENOS Professional profile 2020 black matt



GLENOS Professional profile 2020 white matt



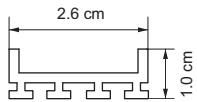

Recommended accessory



Description	Dimensions [cm]	Colour	Item no.
<input checked="" type="checkbox"/> GLENOS End caps, flat, for professional profile 2609 (2 pcs., plastic)	2,6 / 1,0	black matt	LI213770
		white matt	LI213771
		silver	LI213774
<input checked="" type="checkbox"/> GLENOS End caps, curved, for professional profile 2609 (2 pcs., plastic)	2,6 / 2,7	black matt	LI213780
		white matt	LI213781
		silver	LI213784
<input checked="" type="checkbox"/> GLENOS End caps, square, for professional profile 2609 (2 pcs., plastic)	2,6 / 2,7	black matt	LI213790
		white matt	LI213791
<input type="checkbox"/> GLENOS Acrylic cover, flat, for professional profile 2609-100	100 / 2,3 / 0,4	white	LI213741
<input type="checkbox"/> GLENOS Acrylic cover, flat, for professional profile 2609-200	200 / 2,3 / 0,4	white	LI213742
<input type="checkbox"/> GLENOS Acrylic cover, flat, for professional profile 2609-300	300 / 2,3 / 0,4	white	LI213743
<input type="checkbox"/> GLENOS Acrylic cover, curved, for professional profile 2609-100	100 / 2,5 / 2,1	white	LI213751
<input type="checkbox"/> GLENOS Acrylic cover, curved, for professional profile 2609-200	200 / 2,5 / 2,1	white	LI213752
<input type="checkbox"/> GLENOS Acrylic cover, curved, for professional profile 2609-300	300 / 2,5 / 2,1	white	LI213753
<input type="checkbox"/> GLENOS Acrylic cover, square, for professional profile 2609-100	100 / 2,5 / 2,0	white	LI213761
<input type="checkbox"/> GLENOS Acrylic cover, square, for professional profile 2609-200	200 / 2,5 / 2,0	white	LI213762
<input type="checkbox"/> GLENOS Acrylic cover, square, for professional profile 2609-300	300 / 2,5 / 2,0	white	LI213763
<input checked="" type="checkbox"/> GLENOS installation spring for professional profile 2609 (3 pcs., stainless steel)	6,8 / 2,8 / 1,5	stainless steel	LI213799



Booth and store construction | Furniture | Technical lighting



GLENOS Professional profile 2609 silver



GLENOS Professional profile 2609 acrylic cover flat



GLENOS Professional profile 2609 white matt



GLENOS Professional profile 2609 acrylic cover curved



GLENOS Professional profile 2609 black matt



GLENOS Professional profile 2609 acrylic cover square

Description	Installation		Length [cm]	Weight [kg]	Colour	Item no.
	Surface-mounted	Recessed				
<input checked="" type="checkbox"/> GLENOS Professional profile 2609-100	X	X	100	0,19	black matt	LI213700
					white matt	LI213701
					silver	LI213704

Max. width LED strip 21 mm

Recommendation		
LED strip	power supply	feed-in cable
LI552432/33/35	LI470502	LI550413
LI552502/03/05	LI470502	LI550412
LI552402/03/05	LI470502	LI550412
LI552532/33/35	LI470502	LI550412
LI552472/73/75	LI470544	LI550413
LI552532/33/35	LI470502	LI550412



Description	Installation		Length [cm]	Weight [kg]	Colour	Item no.
	Surface-mounted	Recessed				
■ GLENOS □ Professional profile 2609-200 ■	X	X	200	0,38	black matt	LI213710
					white matt	LI213711
					silver	LI213714
Max. width LED strip 21 mm						

Recommendation		
LED strip	power supply	feed-in cable
LI552442/43/45	LI470544	LI550413
LI552542/43/45	LI470544	LI550412
LI552412/13/15	LI470544	LI550412
LI552532/33/35	LI470502	LI550412
LI552482/83/85	LI470506	LI550413
LI552512/13/15	LI470502	LI550412

Description	Installation		Length [cm]	Weight [kg]	Colour	Item no.
	Surface-mounted	Recessed				
■ GLENOS □ Professional profile 2609-300 ■	X	X	300	0,57	black matt	LI213720
					white matt	LI213721
					silver	LI213724
Max. width LED strip 21 mm						

Recommendation		
LED strip	power supply	feed-in cable
LI552442/43/45	LI470544	LI550413
LI552542/43/45	LI470544	LI550412
LI552412/13/15	LI470542	LI550412
LI552542/43/45	LI470544	LI550412
LI552442/43/45	LI470544	LI550413
LI552542/43/45	LI470544	LI550412

GLENOS Professional profile 3030-100 / 200 / 300

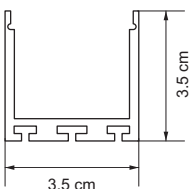

Recommended accessory



GLENOS Cover 100 for professional profile 3030-100

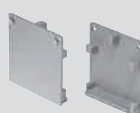

GLENOS End caps for professional profile 3030



GLENOS Suspension set pendant L 2,5 m

Description	Dimensions [cm]	Colour	Item no.
<input type="checkbox"/> GLENOS Cover 100 for professional profile 3030-100	100	white	LI213641
<input type="checkbox"/> GLENOS Cover 200 for professional profile 3030-200	200	white	LI213642
<input type="checkbox"/> GLENOS Cover 300 for professional profile 3030-300	300	white	LI213643
<input checked="" type="checkbox"/> GLENOS End caps for professional profile 3030 (2 pcs.)	3,5 / 3,5 / 0,2	black matt	LI213650
		white matt	LI213651
		silver	LI213654
GLENOS Suspension set	Pendant L 2,5 m		LI213488



Can be converted to a pendant with the optionally available suspension set, item no. LI213488

Description	Installation			Length [cm]	Weight [kg]	Colour	Item no.
	Surface-mounted	Recessed					
<input checked="" type="checkbox"/> GLENOS Professional profile 3030-100 <input type="checkbox"/> <input type="checkbox"/>	X	X	100	0,7	black matt	LI213610	
					white matt	LI213611	
					silver	LI213614	
					Max. width LED strip 30mm		

Recommendation		
LED strip	power supply	feed-in cable
LI552432/33/35	LI470502	LI550413
LI552532/33/35	LI470502	LI550412
LI552402/03/05	LI470502	LI550412
LI552532/33/35	LI470502	LI550412
LI552472/73/75	LI470544	LI550413
LI552532/33/35	LI470502	LI550412

Description	Installation			Length [cm]	Weight [kg]	Colour	Item no.
	Surface-mounted	Recessed					
<input checked="" type="checkbox"/> GLENOS Professional profile 3030-200 <input type="checkbox"/> <input type="checkbox"/>	X	X	200	1,4	black matt	LI213620	
					white matt	LI213621	
					silver	LI213624	
					Max. width LED strip 30mm		

Recommendation		
LED strip	power supply	feed-in cable
LI552442/43/45	LI470544	LI550413
LI552542/43/45	LI470544	LI550412
LI552412/13/15	LI470544	LI550412
LI552532/33/35	LI470502	LI550412
LI552482/83/85	LI470506	LI550413
LI552512/13/15	LI470502	LI550412

Description	Installation			Length [cm]	Weight [kg]	Colour	Item no.
	Surface-mounted	Recessed					
<input checked="" type="checkbox"/> GLENOS Professional profile 3030-300 <input type="checkbox"/> <input type="checkbox"/>	X	X	300	2,1	black matt	LI213630	
					white matt	LI213631	
					silver	LI213634	
					Max. width LED strip 30mm		

Recommendation		
LED Strip	power supply	feed-in cable
LI552472/73/75	LI470544	LI550413
LI552542/43/46	LI470544	LI550412
LI552412/13/15	LI470542	LI550412
LI552542/43/45	LI470544	LI550412
LI552472/73/75	LI470506	LI550413
LI552542/43/46	LI470544	LI550412



GLENOS Professional profile 4970-100

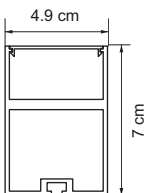

Recommended accessory



GLENOS End caps for professional profile 4970



GLENOS Suspension for professional profile 4970

Description	Dimensions [cm]	colour	Item no.
<input type="checkbox"/> GLENOS End caps for professional profile 4970 (2 pcs.)	7,0 / 4,9 / 0,8	white	LI213481
<input type="checkbox"/> GLENOS End caps for professional profile 4970 (2 pcs.)	7,0 / 4,9 / 0,8	alu anodised	LI213484
GLENOS Suspension for professional profile 4970	250		LI213488



Can be converted to a pendant with the optionally available suspension set, item no. LI213488

Description	Installation		Length [cm]	Weight [kg]	Colour	Item no.	Recommendation	
	Surface-mounted	Recessed					LED strip	power supply
<input type="checkbox"/> GLENOS Professional profile 4970-100	X	X	100	1,5	white	LI213461	LI552572/73/74	LI977399
<input type="checkbox"/> GLENOS Professional profile 4970-100	X	X	100	1,5	alu anodised	LI213464	LI552572/73/74	LI977399

Price incl. cover | Max. width LED strip 37 mm

GLENOS Professional profile 4970-200

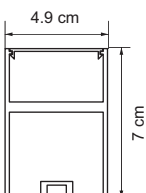

Recommended accessory



GLENOS End caps for professional profile 4970



GLENOS Suspension for professional profile 4970

Description	Dimensions [cm]	Colour	Item no.
<input type="checkbox"/> GLENOS End caps for professional profile 4970 (2 pcs.)	7,0 / 4,9 / 0,8	white	LI213481
<input type="checkbox"/> GLENOS End caps for professional profile 4970 (2 pcs.)	7,0 / 4,9 / 0,8	alu anodised	LI213484
GLENOS Suspension for professional profile 4970	250		LI213488



Can be converted to a pendant with the optionally available suspension set, item no. LI213488

Description	Installation		Length [cm]	Weight [kg]	Colour	Item no.	Recommendation	
	Surface-mounted	Recessed					LED strip	power supply
<input type="checkbox"/> GLENOS Professional profile 4970-200	X	X	200	3,0	white	LI213471	LI552582/83/84	LI977399 (x2)
<input type="checkbox"/> GLENOS Professional profile 4970-200	X	X	200	3,0	alu anodised	LI213474	LI552582/83/84	LI977399 (x2)

Price incl. cover | Max. width LED strip 37 mm

1 power supply per meter

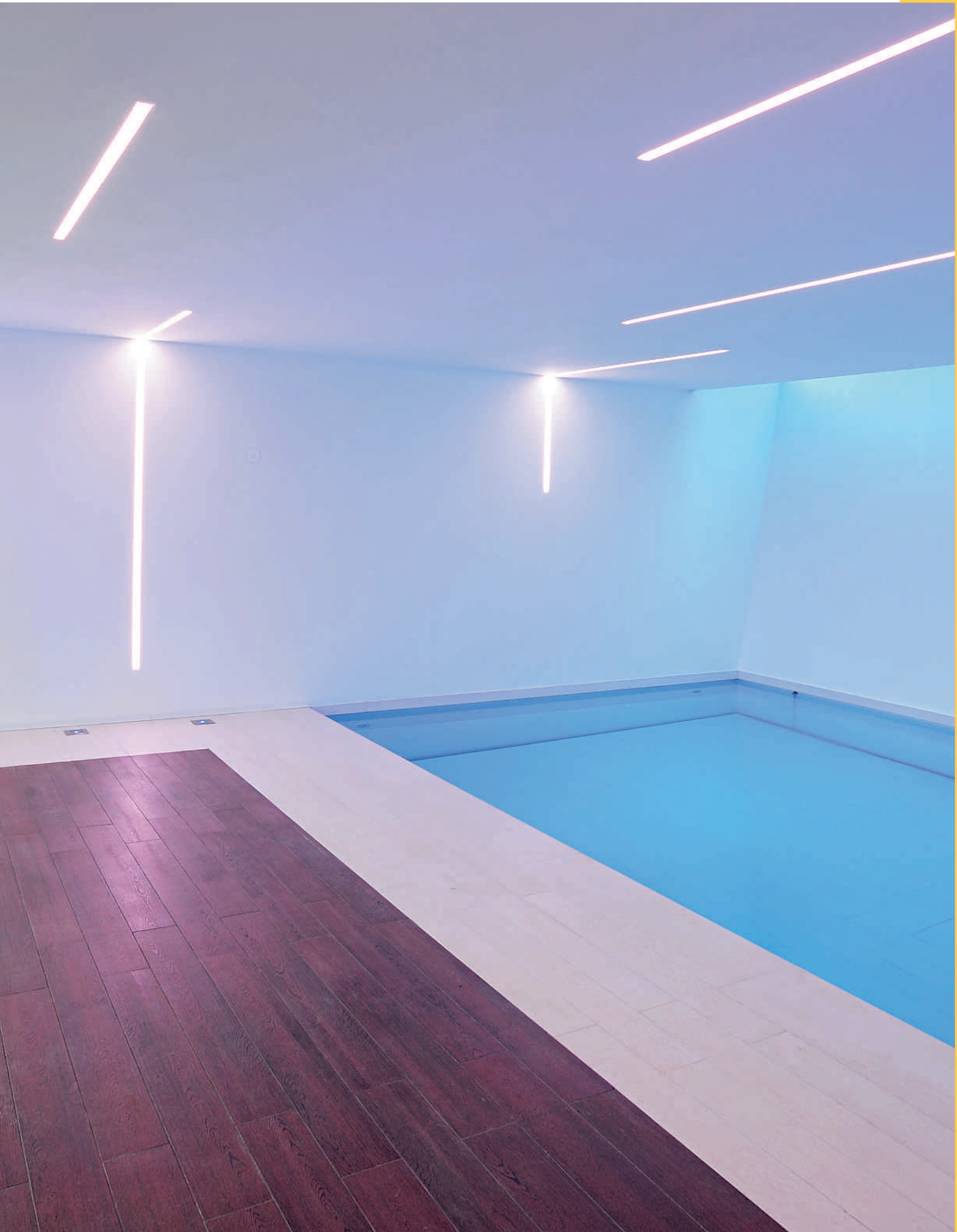

GLENOS Professional recessed profile 8832-100

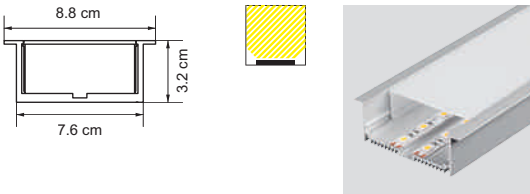

Recommended accessory

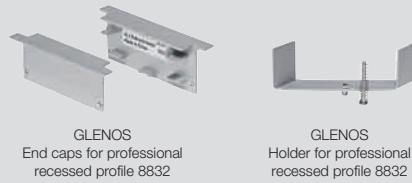

Description	Dimensions [cm]	Colour	Item no.
<input type="checkbox"/> GLENOS End caps for professional recessed profile 8832 (2 pcs.)	3,2 / 8,8 / 1,7	white	LI213521
<input type="checkbox"/> GLENOS End caps for professional recessed profile 8832 (2 pcs.)		alu anodised	LI213524
GLENOS Holder for professional recessed profile 8832 (2 pcs.)	11,2 / 2,0 / 4,0		LI213529



Application in wall or ceiling | Suitable to apply 2 parallel LED strips | Asymmetrical light effect when applying one LED strip

Description	Installation				Colour	Item no.
	Surface-mounted	Recessed	Length [cm]	Weight [kg]		
<input type="checkbox"/> GLENOS Professional recessed profile 8832-100	X		100	1,15	white	LI213501
<input type="checkbox"/> GLENOS Professional recessed profile 8832-100		X			alu anodised	LI213504

Price incl. cover | Suitable for material thickness ceiling/wall: max. 24 mm | In order to ensure cooling, do not glue strip in centre

Recommendation		
LED strip	power supply	feed-in cable
LI552532/33/35 (x2)	LI470544	LI550412 (x2)
LI552472/73/75 (x2)	LI470506	LI550413 (x2)
LI552532/33/35 (x2)	LI470544	LI550412 (x2)
LI552432/33/35 (x2)	LI470542	LI550413 (x2)

Recommendation of 2 strips and 2 feed-ins each

GLENOS Professional recessed profile 8832-200

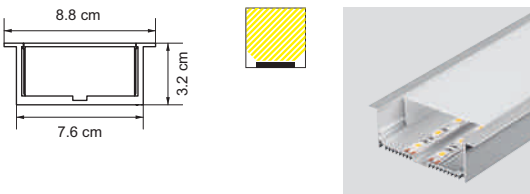

Recommended accessory

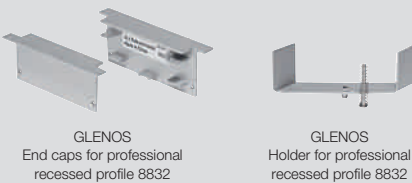

Description	Dimensions [cm]	Colour	Item no.
<input type="checkbox"/> GLENOS End caps for professional recessed profile 8832 (2 pcs.)	3,2 / 8,8 / 1,7	white	LI213521
<input type="checkbox"/> GLENOS End caps for professional recessed profile 8832 (2 pcs.)		alu anodised	LI213524
GLENOS Holder for professional recessed profile 8832 (2 pcs.)	11,2 / 2,0 / 4,0		LI213529



Application in wall or ceiling | Suitable for application of 2 parallel LED strips | Asymmetrical light effect when applying one LED Strip

Description	Installation				Colour	Item no.
	Surface-mounted	Recessed	Length [cm]	Weight [kg]		
<input type="checkbox"/> GLENOS Professional recessed profile 8832-200	X		200	2,3	white	LI213511
<input type="checkbox"/> GLENOS Professional recessed profile 8832-200		X			alu anodised	LI213514

Price incl. cover | Suitable for material thickness ceiling/wall: max. 24 mm | In order to ensure cooling, do not glue strip in centre

Recommendation		
LED strip	power supply	feed-in cable
LI552582/83/85 (x2)	LI470500	LI550413 (x2)
LI552532/33/35 (x2)	LI470506	LI550412 (x2)
LI552542/43/45 (x2)	LI470506	LI550412 (x2)
LI552542/43/45 (x2)	LI470506	LI550413 (x2)

Recommendation of 2 strips and 2 feed-ins each



GLENOS Linear profile 1809-100 / 200



Recommended accessory



	Description	Dimensions [cm]	colour	Item no.
<input type="checkbox"/>	GLENOS Cover 100 for linear profile 1809-100	100	white	LI213821
<input type="checkbox"/>	GLENOS Cover 200 for linear profile 1809-200	200	white	LI213822
<input checked="" type="checkbox"/>	GLENOS End caps for linear profile 1809 (2 pcs., plastic)	1,7 / 0,8	black matt	LI213830
<input type="checkbox"/>			white matt	LI213831
<input type="checkbox"/>			silver	LI213834
<input checked="" type="checkbox"/>	GLENOS 90° connector for linear profile 1809 (2 pcs., plastic)	4,1 / 2,0 / 0,7	black matt	LI213840
<input type="checkbox"/>			white matt	LI213841
<input type="checkbox"/>			silver	LI213844
<input checked="" type="checkbox"/>	GLENOS 90° Holder for linear profile 1809 (2 pcs., stainless steel)	1,8 / 1,0 / 0,8	stainless steel	LI213849



For wall and ceiling installation

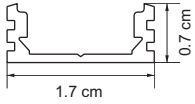

Description	Installation		Length [cm]	Weight [kg]	Colour	Item no.
	Surface-mounted	Recessed				
<input checked="" type="checkbox"/> <input type="checkbox"/> <input type="checkbox"/> GLENOS Linear profile 1809-100	X	X	100	0,13	black matt	LI213800
					white matt	LI213801
					alu anodised	LI213804
Max. width LED strip 12 mm						

Recommendation	
LED strip	power supply
LI552432/33/35	LI470502
LI552532/33/35	LI470502
LI552502/03/05	LI470502
LI552472/73/75	LI470544
LI552402/03/05	LI470502
LI552532/33/35	LI470502

Description	Installation		Length [cm]	Weight [kg]	Colour	Item no.
	Surface-mounted	Recessed				
<input checked="" type="checkbox"/> <input type="checkbox"/> <input type="checkbox"/> GLENOS Linear profile 1809-200	X	X	200	0,26	black matt	LI213810
					white matt	LI213811
					alu anodised	LI213814
Max. width LED strip 12 mm						

Recommendation	
LED strip	power supply
LI552412/13/15	LI470542
LI552542/43/45	LI470544
LI552542/43/45	LI470544
LI552482/83/85	LI470506
LI552442/43/45	LI470544
LI552542/43/45	LI470544





GLENOS Linear profile 1107-100 / 200



Recommended accessory



GLENOS Cover 100 / 200 for profile 1107-100 / 200
GLENOS End caps for linear profile 1107

Description	Dimensions [cm]	Colour	Item no.
<input type="checkbox"/> GLENOS Cover 100 for profile 1107-100	100	white	LI213961
<input type="checkbox"/> GLENOS Cover 200 for profile 1107-200	200	white	LI213962
<input checked="" type="checkbox"/> GLENOS End caps for linear profile 1107 (2 pcs., plastic)	1,1 / 0,6	black matt	LI213970
		white matt	LI213971
		silver	LI213974



For wall and ceiling installation

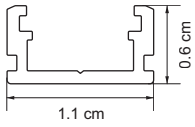

Description	Installation		Length [cm]	Weight [kg]	Colour	Item no.	Recommendation	
	Surface-mounted	Recessed					LED strip	power supply
<input checked="" type="checkbox"/> <input type="checkbox"/> <input type="checkbox"/> GLENOS Linear profile 1107-100	X	X	100	0,07	black matt	LI213940	LI552502/03/05	LI470502
					white matt	LI213941	LI552532/33/35	LI470502
					alu anodised	LI213944	LI552502/03/05	LI470502
Max. width LED strip 7,6 mm							LI552532/33/35	LI470502

Description	Installation		Length [cm]	Weight [kg]	Colour	Item no.	Recommendation	
	Surface-mounted	Recessed					LED strip	power supply
<input checked="" type="checkbox"/> <input type="checkbox"/> <input type="checkbox"/> GLENOS Linear profile 1107-200	X	X	200	0,14	black matt	LI213950	LI552612/13/14	LI470502
					white matt	LI213951	LI552512/13/15	LI470502
					alu anodised	LI213954	LI552612/13/14	LI470502
Max. width LED strip 7,6 mm							LI552512/13/15	LI470502



GLENOS Linear profile 1612-100

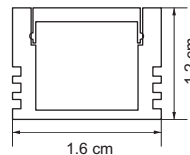

Homogenous illumination | For wall and ceiling installation

Description	Installation					Recommendation		
	Surface-mounted	Recessed	Length [cm]	Weight [kg]	Colour	Item no.	LED strip	power supply
GLENOS Linear profile 1612-100	X		100	0,17	alu anodised	LI213342	LI552502/03/05 LI552532/33/35	LI470502 LI470502
Price incl. cover Max. width LED strip 11 mm								





 **GLENOS** Linear recessed profile 2212-100

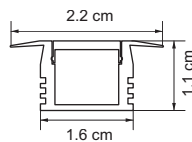

For wall and ceiling installation | Overlying rim to cover inaccuracies in the cutout

Description	Installation					Recommendation		
	Surface-mounted	Recessed	Length [cm]	Weight [kg]	Colour	Item no.	LED strip	power supply
 GLENOS Linear recessed profile 2212-100		X	100	0,18	alu anodised	LI213332	LI552472/73/75 LI552532/33/35	LI470544 LI470502
Price incl. cover Max. width LED strip 11 mm								



GLENOS Linear recessed profile 2508-100

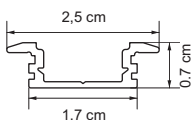

Recommended accessory



Description	Dimensions [cm]	Colour	Item no.
<input type="checkbox"/> GLENOS Cover 100 for linear recessed profile 2508-100	100	white	LI213821
<input type="checkbox"/> GLENOS End caps for linear recessed profile 2508 (2 pcs., plastic)	2,4 / 0,5 / 0,8	silver	LI213874

+ Overlaying rim to cover inaccuracies in the cutout

Description	Installation		Length [cm]	Weight [kg]	Colour	Item no.
	Surface-mounted	Recessed				
<input checked="" type="checkbox"/> GLENOS Linear recessed profile 2508-100		X	100	0,29	alu anodised	LI213861

Max. width LED strip 12 mm

Recommendation	
LED strip	power supply
LI552502/03/05	LI470502
LI552532/33/35	LI470502

GLENOS Linear recessed profile 2508-200

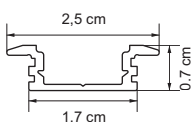

Recommended accessory



Description	Dimensions [cm]	Colour	Item no.
<input type="checkbox"/> GLENOS Cover 200 for linear recessed profile 2508-200	200	white	LI213822
<input type="checkbox"/> GLENOS End caps for linear recessed profile 2508 (2 pcs., plastic)	2,4 / 0,5 / 0,8	silver	LI213874

+ Overlaying rim to cover inaccuracies in the cutout

Description	Installation		Length [cm]	Weight [kg]	Colour	Item no.
	Surface-mounted	Recessed				
<input checked="" type="checkbox"/> GLENOS Linear recessed profile 2508-200		X	200	0,58	alu anodised	LI213862

Max. width LED strip 12 mm

Recommendation	
LED strip	power supply
LI552542/43/45	LI470544
LI552482/83/85	LI470506

LED STRIPS.

—

Light is incredibly manifold. It creates security, leads the way, triggers emotions, sets highlights or provides rooms with a very special atmosphere.

With LED strips you can apply light as a design element individually for any private or professional application and in a great variety of colours for any mood.

LED strips in warm white, neutral white or cold white make for comfortable, technical or daylight-like lighting. With LED strips in RGB, colour moods in red, green or blue as well as a mix of those three colours can be created. With RGB/W strips pastel shades can also be created by mixing white with the red/green/blue colours, or just white light. With dimmable solutions, that can comfortably also be controlled via remote control, or control via e.g. LIM devices there are almost no limits to the possible effects.

The advantages of LED strips:

- Flexibility – since they can be shortened and bent, LED strips can be applied almost anywhere, whether in straight application, curved or installed around the corner
- Effect – LED strips for basic or effect lighting or for decorative purposes
- Play with colours – strips in warm white, cold white, or RGB and RGB/W make for the right colour and mood in any ambiance – dimmable and comfortable, also via remote control
- Wide portfolio – rigid or flexible strips or strips (IP44 / IP65)
- Easy installation due to adhesive surface on the rear side
- Sustainability – LED strips are energy-efficient and thanks to their flexibility easy to shorten and adjust

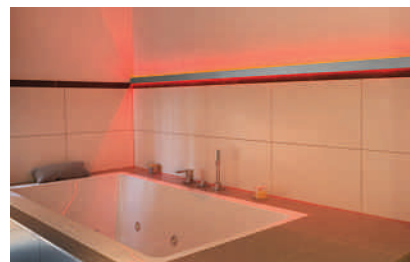
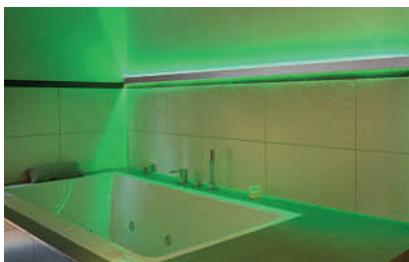
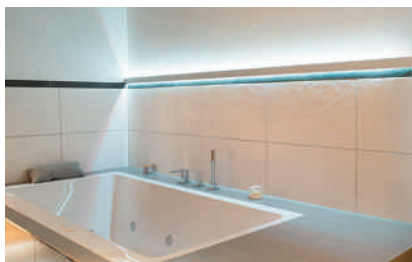
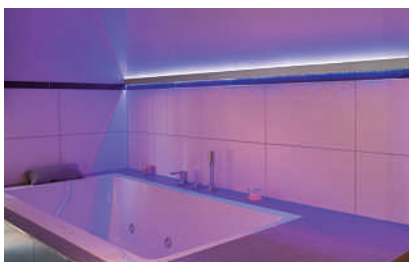
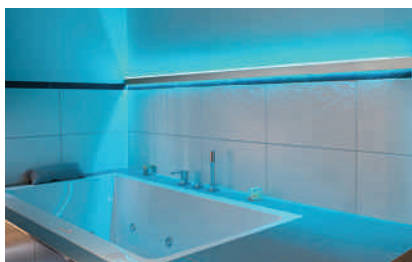

LED wiki:

—

LED

English „light-emitting diode“, produces light by converting electrical energy into visible electro-magnetic radiation.

RGB

Stands for the colours red, green and blue and describes colour-changing products that are used to provide rooms with individual colour moods.

RGBW

Stands for the colours red, green, blue and white and describes colour-changing products that are used to provide rooms with individual, dynamic colour moods or achieve white basic lighting.

Kelvin (K)

Measuring unit for indicating a light source's colour temperature.

Warm white (WW)

Light colour <3300 Kelvin – yellow-white to white light for a comfortable, warm mood, especially in living areas.

Neutral white

Light colour 3300 to 5300 Kelvin – white light for a neutral atmosphere.

Cold white (KW) / daylight white

Light colour >5300 Kelvin – daylight-like light for technical lighting, daylight-like conditions.

Colour rendering index Ra (CRI)

A light source's colour rendering index is indicated with the colour rendering index Ra (English: CRI). The colour rendering index describes the level of accordance of the visible surface colour with its appearance under a specific reference light source.



LED STRIPS 24V=

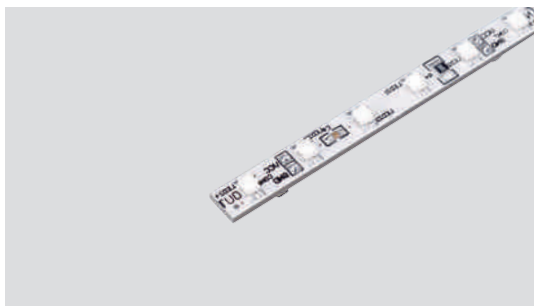

Recommended accessory

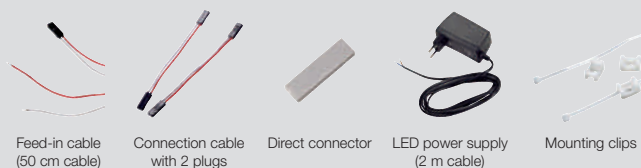

Feed-in cable (50 cm cable) Connection cable with 2 plugs (10 cm cable) Direct connector LED power supply (2 m cable) Mounting clips

Description	Item no.
Feed-in cable (50 cm cable, 2 pcs., 50W max.)	LI550192
Connection cable with 2 plugs (10 cm cable, 10 pcs., 50W max.)	LI550190
Direct connector (10 pcs., 50W max.)	LI550193
LED power supply (2 m Kabel, 16W, 24V=)	LI470571
Mounting clips (100 pcs.)	LI550191

Description	LED colour	Wattage [W]	LED distance [cm]	LEDs per Strip	LEDs/m	Colour rendering	Dimensions [cm]	Seperability [cm]	Weight [kg]	Item no.	Recomm. power supply
LED strips 24V=	6500K	2,2	1,3	24	78	CRI>80	30,5 / 0,7 / 0,7	7,6	0,01	▼ LI550181	LI470542
	3000K	2,2	1,3	24	78	CRI>80	30,5 / 0,7 / 0,7	7,6	0,01	▼ LI550182	LI470506

For a wattage >50W the feed-in must be renewed | When connecting several strips, please keep the total wattage in mind | Further power supplies in the Accessories chapter

FLEXSTRIP LED 24V/DC



Recommended accessory



Clip connector/feed-in (1 pce.) Feed-in with 30 cm cable for strip width up to 8 mm Direkt connector for strip width up to 8 mm

Description	Item no.
Clip connector/feed-in (1 pce., 10A max., 12V=/24V=)	LI550560
Feed-in (30 cm cable, for strip width up to 8 mm)	LI550412
Direct connector (2 pcs., for strip width up to 8 mm)	LI550415

 3Step Mac Adam - particularly suitable for applications that require high colour homogeneity

Description	LED colour	Wattage [W]	LED distance [cm]	LEDs per Strip	LEDs/m	Colour rendering	Dimensions [cm]	Seperability [cm]	Weight [kg]	Item no.	Recomm. power supply
Flexstrip LED 24V/DC	2700K	5	1,7	60	60	CRI>80	100 / 0,8 / 0,12	10	0,03	LI552402	LI470502
	3000K									LI552403	LI470502
	5000K									LI552405	LI470502
	2700K	15	1,7	180	60	CRI>80	300 / 0,8 / 0,12	10	0,09	LI552412	LI470542
	3000K									LI552413	LI470542
	5000K									LI552415	LI470542
2700K	25	1,7	300	60	CRI>80	500 / 0,8 / 0,12	10	0,15	LI552422	LI470544	
3000K									LI552423	LI470544	
5000K									LI552425	LI470544	

In order to ensure constant light output for greater lengths, the strips should not be fed in from both sides | Minimum bending radius 1,3 cm | Separable every 10 cm | Rear sides with adhesive tape | Ta max. +40°C | From a length of 5 m the feed-in must be renewed

FLEXSTRIP LED PRO 24V/DC



Recommended accessory



Clip connector/
feed-in (1 pce.)



Feed-in
with 30 cm cable for strip
width up to 10 mm



Direct connector
for strip width
up to 10 mm

Description	Item no.
Clip connector/feed-in (1 pce., 10A max., 12V=/24V=)	LI550560
Feed-in (30 cm cable, for strip width up to 10 mm)	LI550413
Direct connector (2 pcs., for strip width up to 10 mm)	LI550416



3Step Mac Adam - particularly suitable for applications that require high colour homogeneity

Description	LED colour	Wattage [W]	LED distance [cm]	LEDs per Strip	LEDs/m	Colour rendering	Dimensions [cm]	Seperability [cm]	Weight [kg]	Item no.	Recomm. power supply
Flexstrip LED Pro 24V/DC	2700K	10	1,7	60	60	CRI>80	100 / 1,0 / 0,2	10	0,04	LI552432	LI470502
	3000K									LI552433	LI470502
	5000K									LI552435	LI470502
	2700K	30	1,7	180	1,7	CRI>80	300 / 1,0 / 0,2	10	0,12	LI552442	LI470544
	3000K									LI552443	LI470544
	5000K									LI552445	LI470544

In order to ensure constant light output for greater lengths, the strips should not be fed in from both sides | Minimum bending radius 1,3 cm | Separable every 10 cm | To be operated with 24V/DC power supplies, such as LI470502 | Rear sides with adhesive tape | Ta max. +40°C | From a length of 5 m the feed-in must be renewed

FLEXSTRIP LED HIGH LUMEN 25W/m



Recommended accessory



Clip connector/
feed-in (1 pce.)



Feed-in
with 30 cm cable for strip
width up to 10 mm



Direct connector
for strip width
up to 10 mm

Description	Item no.
Clip connector/feed-in (1 pce., 10A max., 12V=/24V=)	LI550560
Feed-in (30 cm cable, for strip width up to 10 mm)	LI550413
Direct connector (2 pcs., for strip width up to 10 mm)	LI550416



High proximity of LEDs makes for homogenous illumination

Description	LED colour	Wattage [W]	LED distance [cm]	LEDs per Strip	LEDs/m	Colour rendering	Dimensions [cm]	Seperability [cm]	Weight [kg]	Item no.	Recomm. power supply
Flexstrip LED, High Lumen, 25W/m	2700K	21	0,8	120	120	CRI>80	100 / 1,0 / 0,12	10	0,04	LI552472	LI470544
	3000K									LI552473	LI470544
	5000K									LI552475	LI470544
	2700K	42	0,8	240	120	CRI>80	200 / 1,0 / 0,12	10	0,08	LI552482	LI470506
	3000K									LI552483	LI470506
	5000K									LI552485	LI470506

In order to ensure constant light output for greater lengths, the strips should not be fed in from both sides | Minimum bending radius 1,3 cm | Separable every 10 cm | Rear sides with adhesive tape | Ta max. +40°C | From a length of 2 m the feed-in must be renewed



FLEXSTRIP LED RGB/W



Recommended accessory



Feed-in for LED strip RGB/W



Flexible connector for LED strip RGB/W



Direct connector for LED strip RGB/W

Description	Item no.
Feed-in for LED strip RGB/W	LI552460
Flexible connector for LED strip RGB/W	LI552461
Direct connector for LED strip RGB/W	LI552462

 6Step Mac Adam - particularly suitable for applications that require high colour homogeneity

Description	LED colour	Wattage [W]	LED distance [cm]	LEDs per Strip	LEDs/m	Dimensions [cm]	Seperability [cm]	Weight [kg]	Item no.	Recomm. power supply
FLEXSTRIP LED RGB/W	RGBW	16	1,7	60	60	100 / 1,2 / 0,2	10	0,04	LI552451	LI470542
		48	1,7	180	60	300 / 1,2 / 0,2	10	0,12	LI552453	LI470506

In order to achieve full light output, the strip should be fed in from both sides | Luminous flux per meter for warm white: 450lm | for RGBW: 780lm | for RGB: 340lm | Minimum bending radius 1,3 cm | Separable every 10 cm | Rear sides with adhesive tape | Ta max. +40°C | From a length of 3 m the feed-in must be renewed | Please find further recommendations in the Accessories chapter

Color Control.

Your total color lighting system.

Your mood sets the tone: Green light in the morning, red at night? Or dimmable white base lighting? With Color Control you can individually set the colors of your interior RGB/W devices however you feel – via radio control, wall panel, or Bluetooth extension. Our Color Control System operates on a master/slave principle and can be expanded at any time.

Installation example „Plug & Play“

The perfect solution for small scale applications. Example: mood lighting in the bathroom – where RGB/W LED strips around the tub, Lipsy Ceiling Lights, or COLO Lamps can all be remotely controlled.



MASTER CONTROLLER INCL. REMOTE CONTROL & RGB/W LED STRIP



1 LIPSY FITTING (SLAVE)

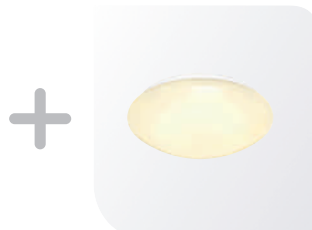

BY THE WAY: EACH MASTER VERSION CAN BE EXTENDED WILL ALL SLAVE VERSIONS.

MORE INFO FROM PAGE 797.

FLEXSTRIP LED 3D 24V/DC, 4W, 60 pcs/m



Recommended accessory



Clip connector/
feed-in (1 pce.)



Feed-in
with 30 cm cable
for strip width up to 8 mm



Direct connector
for strip width up to 8 mm

Description	Item no.
Clip connector/feed-in (1 pce., 10A max., 12V=/24V=)	LI550560
Feed-in (30 cm cable, for strip width up to 8 mm)	LI550412
Direct connector (2 pcs., for strip width up to 8 mm)	LI550415



Flexible strip, can be bent up to 90°

Description	LED colour	Wattage [W]	LED distance [cm]	LEDs per Strip	LEDs/m	Colour rendering	Dimensions [cm]	Seperability [cm]	Weight [kg]	Item no.	Recomm. power supply
FLEXSTRIP LED 3D, 24V/DC, 4W, 60 pcs/m	2700K	4	1,6	60	60	CRI>80	100 / 0,6 / 0,13	10	0,02	LI552502	LI470502
	3000K									LI552503	LI470502
	5000K									LI552505	LI470502
	2700K	12	1,6	180	60	CRI>80	300 / 0,6 / 0,13	10	0,06	LI552512	LI470502
	3000K									LI552513	LI470502
	5000K									LI552515	LI470502
2700K	20	1,6	300	60	CRI>80	500 / 0,6 / 0,13	10	0,1	LI552522	LI470542	
3000K									LI552523	LI470542	
5000K									LI552525	LI470542	

In order to ensure constant light output for greater lengths, the strips should be fed in from both sides | PCB flexible | Strip can be bent more than 90° | Separable every 10 cm | Rear sides with adhesive tape | Ta max. +40°C | From a length of 5 m the feed-in must be renewed

FLEXSTRIP LED 3D 24V/DC, 10W, 60 pcs/m



Recommended accessory



Clip connector/
feed-in (1 pce.)



Feed-in
with 30 cm cable
for strip width up to 8 mm



Direct connector
for strip width up to 8 mm

Description	Item no.
Clip connector/feed-in (1 pce., 10A max., 12V=/24V=)	LI550560
Feed-in (30 cm cable, for strip width up to 8 mm)	LI550412
Direct connector (2 pcs., for strip width up to 8 mm)	LI550415



Flexible strip, can be bent up to 90°

Description	LED colour	Wattage [W]	LED distance [cm]	LEDs per Strip	LEDs/m	Colour rendering	Dimensions [cm]	Seperability [cm]	Weight [kg]	Item no.	Recomm. power supply
FLEXSTRIP LED 3D, 24V/DC, 10W, 60 pcs/m	2700K	10	1,7	60	60	CRI>80	100 / 0,8 / 0,2	10	0,03	LI552532	LI470502
	3000K									LI552533	LI470502
	5000K									LI552535	LI470502
	2700K	30	1,7	180	60	CRI>80	300 / 0,8 / 0,2	10	0,09	LI552542	LI470544
	3000K									LI552543	LI470544
	5000K									LI552545	LI470544

In order to ensure constant light output for greater lengths, the strips should be fed in from both sides | PCB flexible | Strip can be bent more than 90° | Separable every 10 cm | Rear sides with adhesive tape | Ta max. +40°C | From a length of 3 m the feed-in must be renewed



FLEXSTRIP LED PROFESSIONAL 24V/DC



High luminous flux 3700lm – makes for ideal illumination of professional applications

Description	LED colour	Wattage [W]	LED distance [cm]	LEDs per Strip	LEDs/m	Colour rendering	Dimensions [cm]	Seperability [cm]	Weight [kg]	Item no.	Recomm. power supply
Flexstrip LED Professional, 24V/DC	2700K	40	-	180	180	CRI>80	100 / 3,5 / 0,2	5	0,05	LI552572	LI470506 (x1)
	3000K									LI552573	LI470506 (x1)
	4000K									LI552574	LI470506 (x1)
	2700K	80	-	360	180	CRI>80	200 / 3,5 / 0,2	5	0,1	LI552582	LI470506 (x2)
	3000K									LI552583	LI470506 (x2)
	4000K									LI552584	LI470506 (x2)
2700K	120	-	540	180	CRI>80	300 / 3,5 / 0,2	5	0,15	LI552592	LI470506 (x3)	
3000K									LI552593	LI470506 (x3)	
4000K									LI552594	LI470506 (x3)	

In order to ensure constant light output for greater lengths, the strips should be fed in from both sides | Minimum bending radius 1,3 cm | Separable every 5 cm | Rear sides with adhesive tape | Ta max. +40°C | From a length of 1 m the feed-in must be renewed

FLEXSTRIP LED 4,8 mm



Particularly slim strip

Description	LED colour	Wattage [W]	LED distance [cm]	LEDs per Strip	LEDs/m	Colour rendering	Dimensions [cm]	Seperability [cm]	Weight [kg]	Item no.	Recomm. power supply
LED Flexstrip 4,8 mm	2700K	4	1,6	60	60	CRI>80	100 / 0,48 / 0,12	10	0,02	LI552602	LI470502
	3000K									LI552603	LI470502
	4000K									LI552604	LI470502
	2700K	12	1,6	180	60	CRI>80	300 / 0,48 / 0,12	10	0,06	LI552612	LI470502
	3000K									LI552613	LI470502
	4000K									LI552614	LI470502

In order to ensure constant light output for greater lengths, the strips should be fed in from both sides | Minimum bending radius 1,3 cm | Separable every 10 cm | Rear sides with adhesive tape | Ta max. +40°C | From a length of 5 m the feed-in must be renewed



FLEXLED ROLL 24V



Recommended accessory



Clip connector/
feed-in

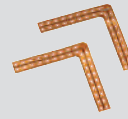

90° solder
corners



Feed-in
with 30 cm cable for strip
width up to 10 mm



Direct connector
for strip width
up to 10 mm

Description	Item no.
Clip connector/feed-in (1 pce., 10A max., 12V=/24V=)	LI550560
90° solder corners (2 pcs., 2A max.)	LI550570
Feed-in (30 cm cable, for strip width up to 10 mm)	LI550413
Direct connector (2 pcs., for strip width up to 10 mm)	LI550416

Description	LED colour	Wattage [W]	LED distance [cm]	LEDs per Strip	LEDs/m	Colour rendering	Dimensions [cm]	Seperability [cm]	Weight [kg]	Item no.	Recomm. power supply
3SDCM LED Flex Strip, 3528, 24V/DC	2700K	5	1,7	60	60	CRI>80	100 / 1,0 / 0,15	10	0,02	LI552100	LI470502
	3000K	5	1,7	60	60	CRI>80	100 / 1,0 / 0,15	10	0,02	LI552102	LI470502
	5700K	5	1,7	60	60	CRI>80	100 / 1,0 / 0,15	10	0,02	LI552101	LI470502
	blue	5	1,7	60	60		100 / 1,0 / 0,15	10	0,02	LI552107	LI470502
	2700K	14	1,7	180	60	CRI>80	300 / 1,0 / 0,15	10	0,05	LI552110	LI470542
	3000K	14	1,7	180	60	CRI>80	300 / 1,0 / 0,15	10	0,05	LI552112	LI470542
	5700K	14	1,7	180	60	CRI>80	300 / 1,0 / 0,15	10	0,05	LI552111	LI470542
	blue	14	1,7	180	60		300 / 1,0 / 0,15	10	0,05	LI552117	LI470542
	2700K	20	1,7	300	60	CRI>80	500 / 1,0 / 0,15	10	0,09	LI552120	LI470542
	3000K	20	1,7	300	60	CRI>80	500 / 1,0 / 0,15	10	0,09	LI552122	LI470542
	5700K	20	1,7	300	60	CRI>80	500 / 1,0 / 0,15	10	0,09	LI552121	LI470542
	blue	20	1,7	300	60		500 / 1,0 / 0,15	10	0,09	LI552127	LI470542

FLEXLED ROLL PRO 24V



Recommended accessory



Clip connector/
feed-in

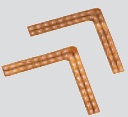

90° solder
corners



Feed-in
with 30 cm cable for strip
width up to 10 mm



Direct connector
for strip width
up to 10 mm

Description	Item no.
Clip connector/feed-in (1 pce., 10A max., 12V=/24V=)	LI550560
90° solder corners (2 pcs., 2A max.)	LI550570
Feed-in (30 cm cable, for strip width up to 10 mm)	LI550413
Direct connector (2 pcs., for strip width up to 10 mm)	LI550416

Description	LED colour	Wattage [W]	LED distance [cm]	LEDs per Strip	LEDs/m	Colour rendering	Dimensions [cm]	Seperability [cm]	Weight [kg]	Item no.	Recomm. power supply
FlexLED Roll Pro 24V	2700K	12	1,7	60	60	CRI>80	100 / 1,0 / 0,2	10	0,04	LI552130	LI470502
	3000K									LI552132	LI470502
	5000K									LI552131	LI470502
	2700K	36	1,7	180	60	CRI>80	300 / 1,0 / 0,2	10	0,12	LI552140	LI470544
	3000K									LI552142	LI470544
	5000K									LI552141	LI470544

FLEXLED ROLL RGB 24V

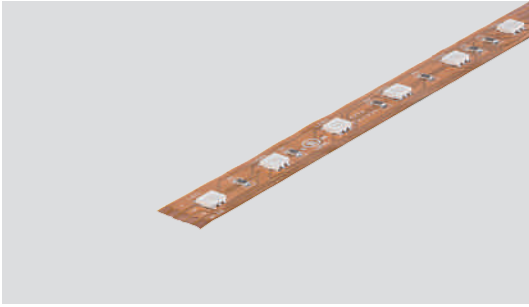

Recommended accessory



Description	Item no.
Feed-in (50 cm cable, max. strip width 15 mm, max. 50W)	LI550418
Direct connector, (1 pce., 15 mm, max. 50W)	LI550419
Coloured light control with Easy LIM® Master controller	LI470650
Easy LIM® RF Slave controller	LI470651

Description	LED colour	Wattage [W]	LED distance [cm]	LEDs per Strip	LEDs/m	Dimensions [cm]	Seperability [cm]	Weight [kg]	Item no.	Recomm. power supply
FlexLED Roll RGB 24V	RGB	12	2,1	48	48	100 / 1,5 / 0,2	12,5	0,04	LI552103	LI470502
		30		300 / 1,5 / 0,2		0,07		LI552113	LI470544	
		41		500 / 1,5 / 0,2		0,10		LI552123	LI470506	

Rear side with adhesive tape | Minimum bending radius: 1,3 cm, ta max. +40°C | Cannot be extended | From a length of 5 m the feed-in must be renewed | Not suitable for general household illumination | When connecting several strips, please keep the total wattage in mind

Connection example 1 for 3 m max.



Power supply 36W, 24V= [LI470544] + Easy LIM® Master controller [LI470650] + FlexLED Roll RGB 24V= [LI552113]

Connection example 2 for 5 m max.



Power supply 60W, 24V= [LI470506] + Easy LIM® Master controller [LI470650] + FlexLED Roll RGB 24V= [LI552123]

Connection example 3 for 2x 5 m max.



Power supply 100W, 24V= [LI470500] + Easy LIM® Master controller [LI470650] + 2x FlexLED Roll RGB 24V= [LI552123]





IP FLEXLED ROLL 24V



Description	LED colour	Wattage [W]	LED distance [cm]	LEDs per Strip	LEDs/m	Colour rendering	Dimensions [cm]	Seperability [cm]	Weight [kg]	Item no.	Recomm. power supply
IP FlexLED Roll 24V	3000K	15	1,7	180	60	CRI>80	300 / 1,3 / 0,5	10	0,20	LI552263	LI470542
	5000K									LI552265	LI470542
	3000K	25	1,7	300	60	CRI>80	500 / 1,3 / 0,5	10	0,33	LI552273	LI470544
	5000K									LI552275	LI470544

Rear side with adhesive tape | Connection lead L: 50 cm | Strip embedded in plastic | Minimum bending radius: 3,75 cm, ta max. -30°C to +40°C | Cannot be extended | From a length of 5 m the feed-in must be renewed | When connecting several strips, please keep the total wattage in mind

IP FLEXLED ROLL RGB 24V



Description	LED colour	Wattage [W]	LED distance [cm]	LEDs per Strip	LEDs/m	Dimensions [cm]	Seperability [cm]	Weight [kg]	Item no.	Recommendation LED controller incl. power supply
IP FlexLED Roll 24V	RGB	30	2,1	144	48	300 / 1,8 / 0,5	12,5	0,30	LI552269	LI470581
		50		240		500 / 1,8 / 0,5		0,50	LI552279	LI470581

Installation optionally with adhesive strips or mounting clips, item no. 550191



LED STRIP OUTDOOR



Recommended accessory



Connection cable IP67
(1 m cable)



Feed-in cable IP67
(5 m cable)



Holding clamp
(10 pcs.)

Description	Item no.
Connection cable IP67 (1 m cable, 50W max.)	LI552331
Feed-in cable IP67 (5 m cable, 50W max.)	LI552330
Holding clamp (10 pcs.)	LI552332

Description	LED colour	Wattage [W]	LED distance [cm]	LEDs per Strip	LEDs/m	Colour rendering	Dimensions [cm]	Weight [kg]	Item no.	Recomm. power supply
LED Strip Outdoor	4000K	6,3	0,7	72	144	CRI>80	51,3 / 2,5 / 2,0	0,25	LI552310	LI470502
	4000K	12	0,7	144	144	CRI>80	101 / 2,5 / 2,0	0,45	LI552320	LI470542

From 50W the feed-in must be renewed





LED PENLIGHT® PRO 230V



Recommended accessory

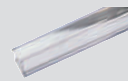

Track (1 m)



End cap (1 pce.)



Feed-in set for LED PenLight® Pro



Mounting clips (100 pcs.)



Gutter clips (10 pcs.)



Long connector (1 pcs.)



Turbo Glue 100

Description	Item no.
Track (1 m)	LI232661
End cap (1 pce., IP44 after glueing with Turbo Glue 100)	LI232691
Feed-in set for LED PenLight® Pro (IP44 after glueing with Turbo Glue 100; end cap, mains plug, rectifier, Turbo Glue 100 [incl.])	LI232700
Mounting clips (100 pcs.)	LI232651
Gutter clips (10 pcs.)	LI232681
Long connector (1 pce., IP44 after glueing with vinegar-free silicone)	LI232641
Turbo Glue 100	LI232600

Description	LED colour	Wattage [W/m]	LED distance [cm]	LEDs per Strip	LEDs/m	Colour rendering	Dimensions [m]	Seperability [cm]	Weight [kg]	Item no.
LED PenLight® Pro 230V	6500K	4,6/1,5	2,77	378	54 / 1,5 m	CRI>65	10,5 / 0,013	150	2,08	LI232711
	2700K									LI232712
	6500K	4,6/1,5	2,77	1458	54 / 1,5 m	CRI>65	40,5 / 0,013	150	6,4	LI232741
	2700K									LI232742

Minimum bending radius: 1,3 cm, ta max. +40°C | From a length of 40,5 m the feed-in must be renewed | Not suitable for general household illumination





RADIO CONTROL

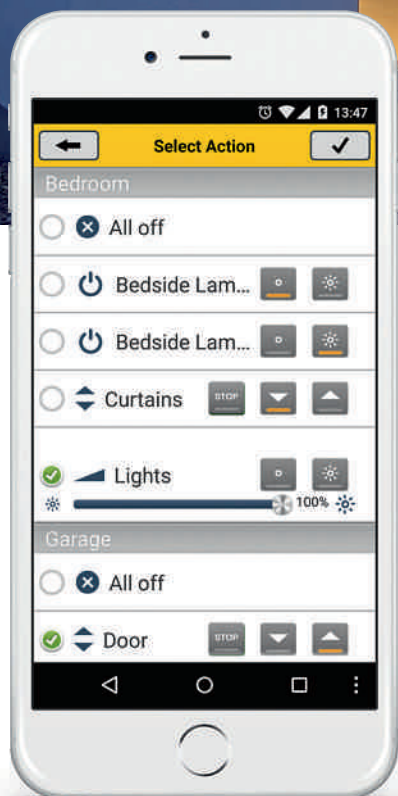

The smart solution for controlling lights, blinds, and much more.

Comfortably control lights and blinds remotely? Move switches to suit different needs after they've already been installed? Connect new appliances to existing systems? All without having to open up walls, or install new wiring? Yes, it's all possible with our radio control solutions. You'll quickly see the advantages, especially when renovating your own home.

All of our transmitters also use a radio frequency (433 MHz) that is specially coded for our receivers. Other wireless appliances – such as routers, telephones, or baby-phones – have different codes and/or frequencies. Why is that important? In order to insure that our receivers cannot be accidentally turned on or off.



More Flexibility

Here today, there tomorrow: Unlike conventional switches, radio switches can be easily moved – with no mess, and no noise. So you can use spaces differently, whenever you want. And new components can be easily added to our wireless SLV CONTROL system at any time.

More Comfort

Switch or dim from wherever you want, whether at home, or out and about? With SLV CONTROL it's easy to do. For instance, via remote control, or with your smartphone, tablet, or computer using our App and Internet Control Station.

More Security

Turn on lights automatically without having to touch a switch? Such as when you are on the basement stairs, or on your way from the garage to the house at night? Not a problem with our radio motion sensors. Our radio solutions provide security advantages as well – with our timers you can simulate home presence and keep burglars away.

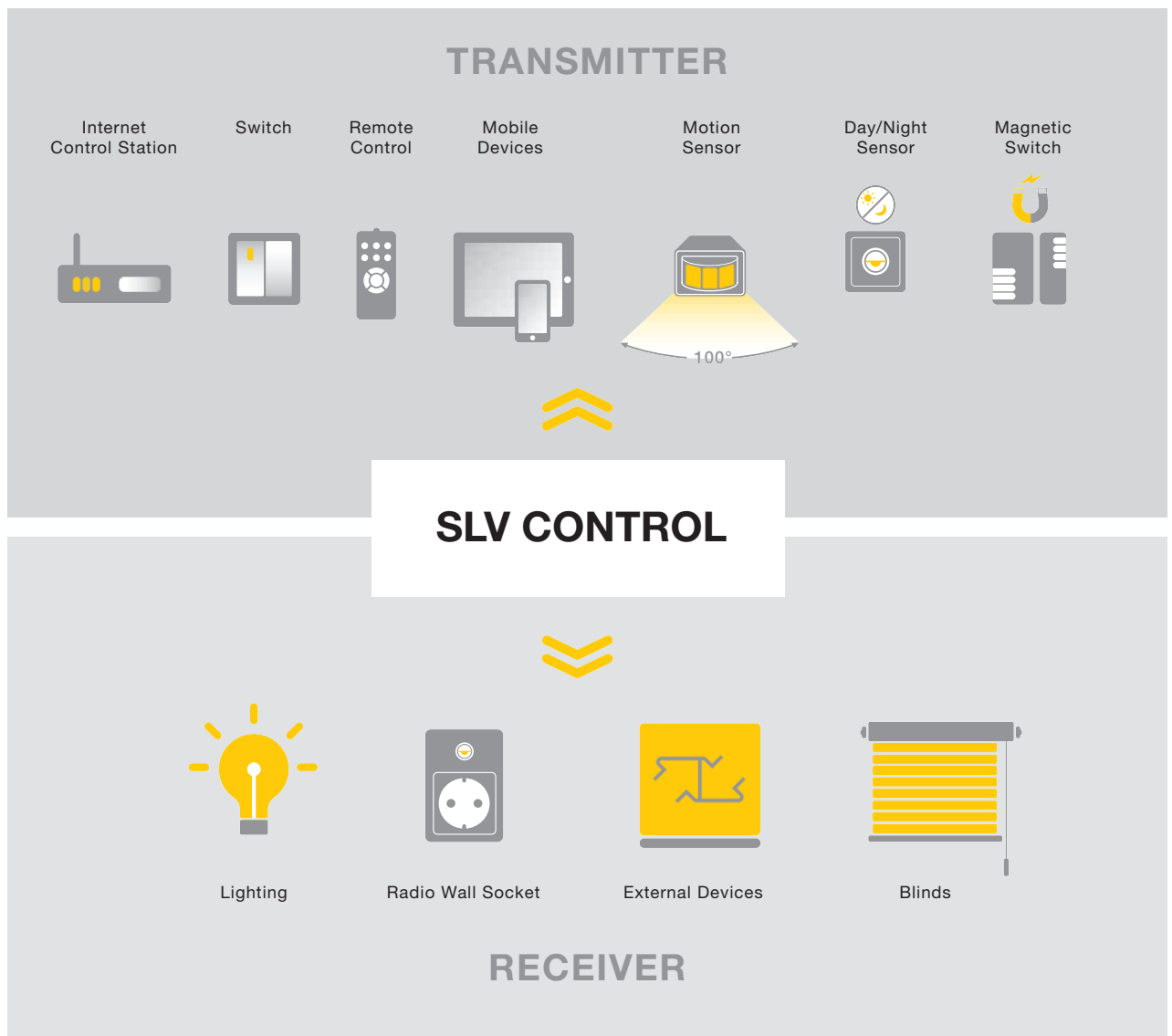



INSTALLATION EXAMPLE 1 Outdoor Lighting



Our transmitters and receivers can be easily combined in any configuration, and thus offer a wide range of possible usages.

For example, outdoor lighting: First, attach the 3-channel radio receiver module to the IP56 connection housing. Then connect the lamps of your choice – built in spots, ceiling and wall lights, or floor stands – to the individual outputs (out 1/2/3). One lamp can be connected for each channel. To link more than one lamp on each channel, simply add a junction box, or IP68 connection box (see accessories).

Now, simply plug everything into a 230 V power source and connect it with our radio transmitter – and you're done.

By the way: With a radio socket switch, mobile lights can also be easily controlled via radio remote control.

Transmitter



Receiver





INSTALLATION EXAMPLE 2 Floor Stands



With our radio wall switches and radio socket switches you can easily expand existing installations and turn lights on and off from anywhere you like. If that's not enough: you can use this set up to remotely control other devices.

Transmitter



Receiver



INSTALLATION EXAMPLE 3 Blinds



Do you know the feeling? You've just taken off, then you suddenly realize that you forgot to lower the shutters and blinds. Now, with the SLV Control App you can use your smartphone to access your SLV Internet Controller at home and close your shutters via radio control. SLV Control – practical security solutions for your home.

Transmitter



Receiver



INTERNET CONTROL STATION



Description	RF coverage in m [indoor]	Width in cm	Height in cm	Depth in cm	Item no.
Internet Control Station	30,0 max.	16,5	3,3	13,0	LI470801



Note: With the free SLV app for iOS or Android all pre-programmed light scenes/sources/circuits can be comfortably and wirelessly controlled. You can download the app for iOS or Android for free in the Apple/Google Play Store. Can also be controlled via web browser. For single fittings and/or light sequences different timers can be set. Operation of up to 48 independent lamps or devices. Set interval timers for automatic switching of you fittings or devices. Create sequences in which you can operate several lamps or devices in a set order with just one button. Sunrise/sunset function. Several tablets/smartphones can be connected to the Internet Control Station. Incl. power supply unit and network cable.

RADIO REMOTE CONTROL, 16-channel



Description	RF frequency in MHz	RF coverage in m [indoor]	RF coverage in m [outdoor]	Length in cm	Width in cm	Height in cm	Item no.
Radio Remote Control, 16-channel	433,92	30,0 max.	70,0 max.	13,0	3,4	1,2	LI470800

Accessories/Included: 1x 3V Lithium battery CR2032 [incl.]
Note: Automatic code system. 16 channels with group function. For controlling the receiver modules.

RADIO OUTDOOR MOTION SENSOR

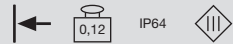

Description	RF frequency in MHz	RF coverage in m [indoor]	RF coverage in m [outdoor]	Width in cm	Height in cm	Depth in cm	Item no.
Radio Outdoor Motion Sensor	433,92	30,0 max.	70,0 max.	8,4	9,0	9,9	LI470809

Accessories/Included: Battery operation: 2x 1,5V AAA [excl.]
Note: Coverage angle (horizontal): 20°-110°
 Coverage angle (vertical): 65°
 Coverage distance: max. 7 m
 Switching off delay: 5s, 1min, 5min, 10min
 Ambiance brightness activation: H = always active; - M = active if ambiance brightness <20lux; - L = active if ambiance brightness <10lux

RADIO INDOOR MOTION SENSOR



Description	RF coverage in m [indoor]	Width in cm	Height in cm	Depth in cm	Item no.
Radio Indoor Motion Sensor	30,0 max.	8,0	8,0	2,7	LI470813

Accessories/Included: Battery operation: 2x 1,5V AAA [excl.]
Note: Coverage angle (horizontal): 20°-80°
 Coverage angle (vertical): 65°
 Coverage distance: max. 7m
 Switching off delay: 5s, 1min, 5min, 10min
 Ambiance brightness activation: H = always active; - M = active if ambiance brightness <20lux; - L = active if ambiance brightness <10lux
 Can be fixated or glued on smooth surfaces.

RADIO WALL SWITCH, single



Description	RF coverage in m [indoor]	Width in cm	Height in cm	Depth in cm	Item no.
Radio Wall Switch, single	30,0 max.	7,9	7,9	1,7	LI470812

Accessories/Included: Battery CR2032 [incl.]
Note: Switching off delay: 5s, 30s, 2min, 10min, 30min, 1h, 3h or non-stop operation/manually switching on and off. Can be fixated or glued on smooth surfaces.



RADIO WALL SWITCH, double



Description	RF coverage in m [indoor]	Width in cm	Height in cm	Depth in cm	Item no.
Radio Wall Switch, double	30,0 max.	7,9	7,9	1,7	LI470819

Accessories/Included: Battery CR2032 [incl.]
Note: Switching off delay: 5s, 30s, 2min, 10min, 30min, 1h, 3h or non-stop operation/manually switching on and off.
 Can be fixated or glued on smooth surfaces.

BRIGHTNESS SENSOR



Description	RF coverage in m [indoor]	RF coverage in m [outdoor]	Width in cm	Height in cm	Depth in cm	Item no.
Radio Day/Night Sensor	30,0 max.	70,0 max.	5,9	8,8	2,7	LI470815

Accessories/Included: Battery operation: 2x 1,5V AAA [excl.]
Note: Switching off delay: 2/3/4/5/6/7/8h, or without switching off delay: Light turns off automatically in the morning as soon as the ambient brightness reaches the same value.
 Saving the current brightness as level for on/off switching.

RADIO MAGNET SWITCH



Description	RF coverage in m [indoor]	Width in cm	Height in cm	Depth in cm	Item no.
Radio Magnet Switch	30,0 max.	2,9	7,4	1,7	LI470814
		1,6	7,4	1,7	

Accessories/Included: Battery CR2032 [incl.]
Note: Switching off delay: 2/4/6/8/10/15/20min or manually switching on and off.

3-CHANNEL RADIO RECEIVER MODULE



Description	RF frequency in MHz	RF coverage in m [indoor]	RF coverage in m [outdoor]	Total wattage	Length in cm	Width in cm	Height in cm	Item no.
3-Channel Radio Receiver Module	433,92	30,0 max.	70,0 max.	3500W max.	9,8	3,0	6,1	LI470803

Note: Radio coverage up to 30 m indoors (depending on the local conditions).
 Radio coverage up to 70 m outdoors (given ideal conditions).
 Up to 6 radio transmitters can be taught per channel.
 Compatible with incandescent lamps, halogen lamps, compact fluorescent lights, LED lamps and fluorescent tubes with electronic ballast.
 Not compatible with fluorescent tubes with conventional ballasts.

IP56 OUTDOOR HOUSING, for 3-channel receiver module



Description	Ø Connection lead in mm	Length in cm	Width in cm	Height in cm	Item no.
IP56 Outdoor Housing, for 3-channel receiver module	7-12	16,4	4,8	10,9	LI470804

Accessories/Included: Screws [incl.], 4 cable screw connections [incl.]
 For IP-safe outdoor installation of the receiver [LI470803].



Connection box with 3-channel receiver module

RADIO SOCKET SWITCH



Description	RF coverage in m [indoor]	RF coverage in m [outdoor]	Total wattage	Width in cm	Height in cm	Depth in cm	Item no.
Radio Socket Switch	30,0 max.		3500W max.	5,3	9,8	6,9	LI470805

Note: Up to 6 radio transmitters can be taught.

RADIO SOCKET OUTDOOR

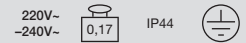

Description	RF frequency in MHz	RF coverage in m [indoor]	RF coverage in m [outdoor]	Total wattage	Length in cm	Width in cm	Height in cm	Item no.
Radio Socket Outdoor	433,92	30,0 max.	70,0 max.	3500W max.	12,3	8,3	3,7	LI470808

Note: Up to 6 radio transmitters can be taught.

RADIO RECESSED MULTIDIMMER, with 6 memory addresses



Description	RF coverage in m [indoor]	RF coverage in m [outdoor]	Total wattage	Width in cm	Height in cm	Depth in cm	Item no.
Radio Recessed Multidimmer, with 5 memory addresses	30,0 max.	70,0 max.	200W max. LED & ESL 24W max.	6,9	5,4	2,9	LI470807

Note: Up to 6 radio transmitters can be taught.

Compatible with incandescent lamps, halogen lamps, compact fluorescent lights and LED lamps.

Not compatible with fluorescent tubes with conventional ballasts.

For halogen lamps use only one transformer per receiver.

RADIO RECESSED SWITCH, with 6 memory addresses

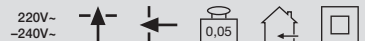

Description	RF coverage in m [indoor]	RF coverage in m [outdoor]	Total wattage	Width in cm	Height in cm	Depth in cm	Item no.
Radio Recessed Switch, with 6 memory addresses	30,0 max.	70,0 max.	1000W max.	6,8	5,3	2,5	LI470806

Note: Up to 6 radio transmitters can be taught.

Compatible with incandescent lamps, halogen lamps, compact fluorescent lights, LED lamps and fluorescent tubes with electronic ballast.

Not compatible with fluorescent tubes with conventional ballasts.

SIGNAL AMPLIFIER



Description	RF coverage in m [indoor]	RF coverage in m [outdoor]	Width in cm	Height in cm	Depth in cm	Item no.
Signal Amplifier	30,0 max.	70,0 max.	10,0	10,0	4,0	LI470810

Accessories/Included: Battery operation: 2x 1,5V AA [excl.]

Note: Up to 6 radio transmitters can be taught. Extends the reception range.



RECEIVER, for controlling blinds



Description	RF coverage in m [indoor]	Total wattage	Width in cm	Height in cm	Depth in cm	Item no.
Receiver, for controlling blinds	30,0 max.	500W max.	6,8	5,3	2,5	LI470816

Note: Up to 6 radio transmitters can be taught.

RADIO SWITCH MODULE, for outlet socket installation



Description	RF coverage in m [indoor]	Total wattage	Width in cm	Height in cm	Depth in cm	Item no.
Radio Switch Module, for outlet socket installation	30,0 max.	30-230W	4,2	4,5	1,4	LI470817

Note: Up to 6 radio transmitters can be taught.

Compatible with incandescent lamps, 230V halogen lamps, 12V halogen lamps with electronic transformer, compact fluorescent lamps, LED lamps and fluorescent tubes with electronic ballasts.

RADIO SWITCH MODULE, for outlet socket installation, with neutral conductor

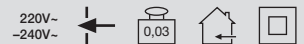

Description	RF coverage in m [indoor]	Total wattage	Width in cm	Height in cm	Depth in cm	Item no.
Radio Switch Module, for outlet socket installation, with neutral conductor	30,0 max.	300W max. LED & ESL 120W max.	4,1	4,7	1,7	LI470818

Note: Up to 6 radio transmitters can be taught.

Switch light on/off with radio transmitter or existing switch.

RADIO DIMMER MODULE, for outlet socket installation



Description	RF coverage in m [indoor]	Total wattage	Width in cm	Height in cm	Depth in cm	Item no.
Radio Dimmer Module for outlet socket installation	30,0 max.	20-250W max. LED & ESL 3-24W max.	4,2	4,5	1,4	LI470811

Note: Up to 6 radio transmitters can be taught.

Not compatible with dimmable lamps and fittings.

RADIO SWITCH MODULE, for switching flush sockets



Description	RF coverage in m [indoor]	Total wattage	Width in cm	Height in cm	Depth in cm	Item no.
Radio Switch Module, for switching flush sockets	30,0 max.	3500W max.	4,0	4,1	1,5	LI470820

Note: Up to 6 radio transmitters can be taught.

Any electronic device (Ohmic loads) with connection lead can be controlled.



COLOR CONTROL

YOUR TOTAL COLOR LIGHTING SYSTEM.

Your mood sets the tone: Green light in the morning, red at night? Or dimmable white base lighting? With Color Control you can individually set the colors of your interior RGB/W

devices however you feel – via radio control, wall panel, or Bluetooth extension. Our Color Control System operates on a master/slave principle and can be expanded at any time.



SLV COLOR CONTROL APP

Color Control not only offers maximum flexibility, it also affords you maximal comfort. This system allows you to set up three different colour zones in any number of rooms, as well as the possibility of adding as many light sources as you like within a 15 meter radius. Depending on your needs and design tastes, the system can be completed with our Lipsy fittings and RGB/W LED Strips, or expanded further still with COLO Lamp equipped table lamps, stands, and pendants.

It's also good to know that the integrated WiFi system that serves as the master/slave connector – providing synchronized color shifts without the need for additional wiring – operates independently of existing WiFi networks and is not susceptible to interference from these. And if your installation needs require covering distances greater than 15 meters, a signal amplifier will insure continually flawless system performance.



INSTALLATION EXAMPLE Plug & Play

The perfect solution for small scale applications. Example: mood lighting in the bathroom – where RGB/W LED strips

around the tub, Lipsy Ceiling Lights, or COLO Lamps can all be remotely controlled.

MASTER CONTROLLER INCL. REMOTE CONTROL & RGB/W LED STRIP



1 LIPSY FITTING (SLAVE)



1 COLO LAMP (SLAVE)

OR



INSTALLATION EXAMPLE large scale use

The perfect solution for anyone who wants to create several colour schemes with a number of different fittings in one large room, or several adjacent rooms, and also wants a wide range of control options (remote control, central wall panel

and smartphone App). Example: RGB/W LED strips illuminate a built-in shelf, COLO Lamps are fitted in table lamps, pendants and stands, and a Lipsy is installed as a wall light in the living and dining room.

REMOTE CONTROL

WALL CONTROL PANEL + OPTIONAL BLUETOOTH MODULE FOR CONTROL VIA APP



LIPSY FITTINGS [ANY NUMBER]

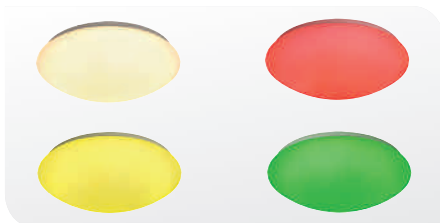

COLO LAMPS [ANY NUMBER]



RGB/W LED STRIP & SLAVE CONTROLLER



OPTIONAL:
SIGNAL AMPLIFIER
FOR INSTALLATIONS
EXCEEDING A 15 METER RADIUS

ALSO: EVERY MASTER VERSION CAN
BE EXPANDED WITH EVERY SLAVE
VERSION.

MORE INFORMATION ON PAGE 797.

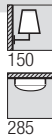

LIPSY 36 / 50 M COLOR CONTROL

Wall and ceiling light, Master



230V~

RGB LED
24 pcs.

130°



- Full set for coloured light control
- Can be combined with all items of the Color Control range – page 794 ff
- Synchronisation by built-in independent WLAN network
- Different static and dynamic colours as well as colour and white mode can be set

NEW

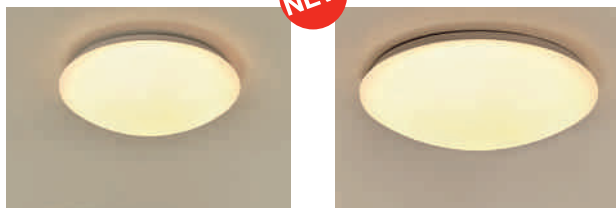
W LED
182 pcs.

0,86

W LED
210 pcs.

1,54

**Lamp [incl.]:**

SMD LED

Total consumption: 41W [L1133749]

Total consumption: 46W [L1133759]

Material:

Steel/acrylic glass

Dimensions:

Ø/H: 35/11 cm [L1133749]

Ø/H: 48,5/13,5 cm [L1133759]

Accessories/Included:

Power supply unit [incl.]

Controller [incl.]

Radio remote control [incl.]

Note:

RGBW fitting with built-in Master controller and radio remote control. Can be extended with Slave fitting [L1133748] or [L1133758]. Coverage remote control and WLAN about 15 m, depending on the local conditions. Coverage can be extended with repeater [L1470674].

Models:

Lipsy 36 M Color Control

RGB + 3000K, 2060lm, CRI 80

□ white

Item no.:

L1133749

Lipsy 50 M Color Control

RGB + 3000K, 3400lm, CRI 80

□ white

L1133759

Coming soon: January 2016

LIPSY 36 / 50 M COLOR CONTROL

Wall and ceiling light, Slave



230V~

RGB LED
24 pcs.

130°

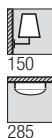

- Full set for coloured light control
- Can be combined with all items of the Color Control range – page 794 ff
- Synchronisation by built-in independent WLAN network

NEW

W LED
182 pcs.

0,86

W LED
210 pcs.

1,54

Lamp [incl.]:

SMD LED

Total consumption: 41W [L1133749]

Total consumption: 46W [L1133758]

Material:

Steel/acrylic glass

Dimensions:

Ø/H: 35/11 cm [L1133749]

Ø/H: 48,5/13,5 cm [L1133758]

Accessories/Included:

Power supply unit [incl.]

Controller [incl.]

Note:

RGBW fitting with built-in Slave controller for operation with Master fitting [L1133749, L1133759] or wall panel [L1470670].

Models:

Lipsy 36 M Color Control

RGB + 3000K, 2060lm, CRI 80

□ white

Item no.:

L1133748

Lipsy 50 M Color Control

RGB + 3000K, 3400lm, CRI 80

□ white

L1133758

Coming soon: January 2016



COLOR CONTROL, Wall control panel



NEW

Description	Wattage	Wattage standby	Width in cm	Height in cm	Depth in cm	Cover depth in cm	Installation Ø in cm	Installation depth in cm	Item no.
RGBW Controller	<2W	<0,5W	8,6	8,6	5	1	5,5	4	LI470670

Touchpanel with glass front to trigger Slave Controller [LI470672], Slave Bulb [LI470673]. Coverage of the touch panel can be extended with WLAN signal amplifier [LI470674]; transmission frequency WLAN 2,4-2,48GHz; coverage about 15 m, depending on the local conditions. Bluetooth Module [LI4706754] for operation via smartphone/tablet app can be upgraded. 34 pre-set programmes, 10 speed levels, 30 pre-set static colours, 5 brightness levels for RGB, 10 brightness levels for white. Optionally controllable with remote control [LI470677].

Suitable for installation in outlet sockets with a min. 40 mm depth.

Accessories/Included: Surface-mounted housing [incl.]



COLOR CONTROL, Master controller + remote control

12V=
or
24V=



NEW

Description	Voltage primary in DC	Voltage secondary in DC	Output power per channel	Length in cm	Width in cm	Height in cm	Connection lead L in cm	Item no.
RGBW Master Control with Remote Control	12V	12V	max. 18W	8,6	2,1	0,85	12	LI470671
	24V	24V	max. 36W					

Master Controller with remote control to connect LED Strips 12-24VDC or trigger Slave Bulb [LI470673], can be extended with Slave Controller [LI470672]. Coverage of the controller can be extended with WLAN Sync. Signal amplifier [LI470674]; transmission frequency WLAN 2,4-2,48GHz; coverage about 15 m, depending on the local conditions. Coverage can be extended with Repeater [LI470674]. 34 pre-set programmes, 10 speed levels, 30 pre-set static colours, 5 dimming levels for RGB, 10 dimming levels for white. Protected against reverse current, overload, short circuit and overheating.

Accessories/Included: Remote control incl. [L/W/H: 11,4/5,6/2,4], Connection lead L: 12 cm, 2 batteries AAA 1,5V [excl.]

COLOR CONTROL, Slave controller

12V=
or
24V=



NEW

Description	Voltage primary in DC	Voltage secondary in DC	Output power per channel	Length in cm	Width in cm	Height in cm	Connection lead L in cm	Item no.
RGBW Slave Controller	12V	12V	max. 18W	8,6	2,1	0,85	12	LI470672
	24V	24V	max. 36W					

Slave Controller for extending the Master Controller [LI470670, LI470671] and Master Bulb [LI470676]; reception frequency WLAN 2,4-2,48GHz; Protected against reverse current, overload, short circuit and overheating.

COLOR CONTROL, Signal amplifier

12V=



NEW

Description	Operating voltage in DC	Total wattage	Length in cm	Width in cm	Height in cm	Item no.
Repeater	12V	2W	8	8	2	LI470674

Signal amplifier for extending the coverage of the Wall Touch Panel [LI470670], the Master Controller [LI470671] and the RGBW Master Bulb [LI470676]; Coverage: 200m max., depending on the local conditions. Reception/transmission frequency WLAN 2,4-2,48GHz. Protected against reverse current, overload, short circuit and overheating.

Accessories/Included: Power supply unit incl. [prim. 100-240V/50-60Hz, sec. 12Vdc/500mA]

COLOR CONTROL, Bluetooth adapter



NEW

Description	Operating voltage in DC	Total wattage	Item no.
Adapter	4,1V	0,5W	LI470675

Optional Bluetooth Module for installation in the Wall Panel [LI470670], to be operated via smartphone or tablet with Bluetooth V2.1 or higher; App iOS, Android are available for download, Windows in preparation. Communication coverage 10 m, depending on the local conditions.

Accessories/Included: App for iOS/Android [incl.]

COLOR CONTROL, Remote control



NEW

Description	Length in cm	Width in cm	Height in cm	Item no.
Remote Control	11,4	5,6	2,4	LI470677

Remote control as optional controller for the RGBW Touch Controller Wall Panel [LI470670]; replacement controller for Master Controller [LI470671] and Master Bulb [LI470676]; transmission frequency: 433,92MHz.

Accessories/Included: 2 batteries AAA 1,5V [excl.]



PERFECT DIMMING SYSTEM



SLV's new Perfect Dimming System is indeed the perfect solution for anyone who may ever want to dim LED downlights – flicker free, from 10% to 100%.

The trick: Unlike previous solutions, our system can be easily integrated into existing installations – with absolutely no rewiring. The only things that you need are your downlights, the right LED driver, and an SLV inverter.

Then, just connect the inverter to the existing wiring in the switch box – and you're finished.

That makes our new Perfect Dimming System the ideal upgrade solution. To put it another way: there is no quicker, more reliable, or more economical way to dim your LED downlights. You can find a complete list of Perfect Dimming System compatible downlights online.

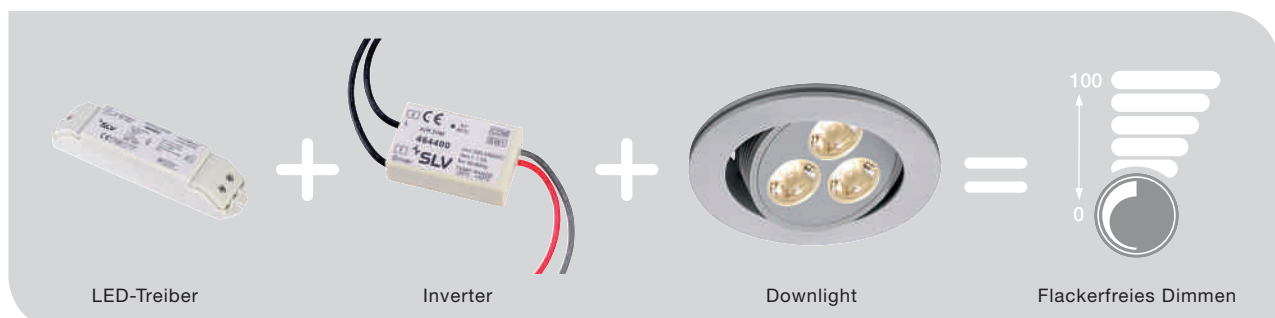



PERFECT DIMMING SYSTEM
Electronic ballast – Inverter



Easy integration into existing installation, no additional lines required. Flicker-free dimming.
Cost-saving since switch only has to be exchanged with sensing device, no expensive dimming switch required.



Description	Output current	Specification	Length in cm	Width in cm	Height in cm	Item no.
Perfect Dimming Electronic Ballast	1,5A	ta: 50°C/tc: 80°C	4,5	2,8	1,3	LI464400

Inverter for operation in combination with Perfect Dimming LED drivers LI464401/-2/-3; for controlling max. 14 PERFECT DIMMING LED drivers; Installation of the inverter in standard outlet sockets.

PERFECT DIMMING SYSTEM
Electronic ballast – LED driver 350mA, 18W



Description	Output power	Output current	Specification	Power factor	Length in cm	Width in cm	Height in cm	Item no.
Perfect Dimming Electronic ballast	18W	350mA	ta: 50°C/tc: 80°C	0,9 λ	16,7	3,9	3,0	LI464401

Dimmable LED driver for operation in combination with Perfect Dimming Inverter LI464400; output voltage 8,5–51Vdc; standby wattage <0,5W; dimming range between 10% and 100%; independent converter; short-circuit-proof

PERFECT DIMMING SYSTEM
Electronic ballast – LED driver 500mA, 18W



Description	Output power	Output current	Specification	Power factor	Length in cm	Width in cm	Height in cm	Item no.
Perfect Dimming Electronic ballast	18W	500mA	ta: 50°C/tc: 80°C	0,9 λ	16,7	3,9	3,0	LI464402

Dimmable LED driver for operation in combination with Perfect Dimming Inverter LI464400; output voltage 6–36Vdc; standby wattage <0,5W; dimming range between 10% and 100%; independent converter; short-circuit-proof







PERFECT DIMMING SYSTEM
Electronic ballast – LED driver 700mA, 18W



Description	Output power	Output current	Specification	Power factor	Length in cm	Width in cm	Height in cm	Item no.
Perfect Dimming Electronic ballast	18W	700mA	ta: 50°C/tc: 80°C	0,9 λ	16,7	3,9	3,0	LI464403

Dimmable LED driver for operation in combination with Perfect Dimming Inverter LI464400; output voltage 4,3–25Vdc; standby wattage <0,5W; dimming range between 10% and 100%; independent converter; short-circuit-proof

LED ACCESSORIES

Converters, Dimmers	 803	LED Controllers	 803-805	LED Power Supply Units	 806-807	LED Drivers	 807-811
Multi-way Connectors	 811	Cable Extensions	 811	Distributors for LED spots in series connection	 812		

BALLASTS, TRANSFORMERS

Ballasts Conventional/Electronic	 812	Transformers Conventional	 813	IP Transformers Conventional	 813-814	Transformers Electronic	 815-816
----------------------------------	--	---------------------------	--	------------------------------	---	-------------------------	--

CONNECTION BOXES

Connection Boxes	 816	Transformer Boxes	 817	Connection Boxes	 817
------------------	--	-------------------	--	------------------	---

GENERAL ACCESSORIES

Motion Sensors	 818	Multiple Sockets	 818	Coloured Cables for pendants	 818	Sockets	 819
LV Distributor Box	 819	Lamp Pliers	 819	Sticker Sets to individualize plaster fittings	 801		



NEW

STICKER SETS

To individualize plaster fittings

Description	Number	Colour	Width in cm	Height in cm	Item no.
Sticker Totem Owl	00	black	17	140	L1155980
	01	white			L1155990
Sticker Totem Cat	10	black	10	37	L1155981
	11	white			L1155991
Sticker Totem Bear	20	black	10	35	L1155982
	21	white			L1155992
Sticker Totem Dog	30	black	10	47	L1155983
	31	white			L1155993
Sticker Totem Fox	40	black	10	32	L1155984
	41	white			L1155994

Description	Number	Colour	Width in cm	Height in cm	Item no.
Sticker Totem Skull	50	black	11	79	L1155985
	51	white			L1155995
Sticker Totem Frog	60	black	11	66	L1155986
	61	white			L1155996
Sticker Bones	70	black	54	10	L1155987
	71	white			L1155997
Sticker Fairytale	80	black	51	10	L1155988
	81	white			L1155998
Sticker Space	90	black	53	10	L1155989
	91	white			L1155999

SCHEMATIC DIAGRAMS

Parallel connection for high wattages.
At a wattage >50W the feed-in must be renewed.

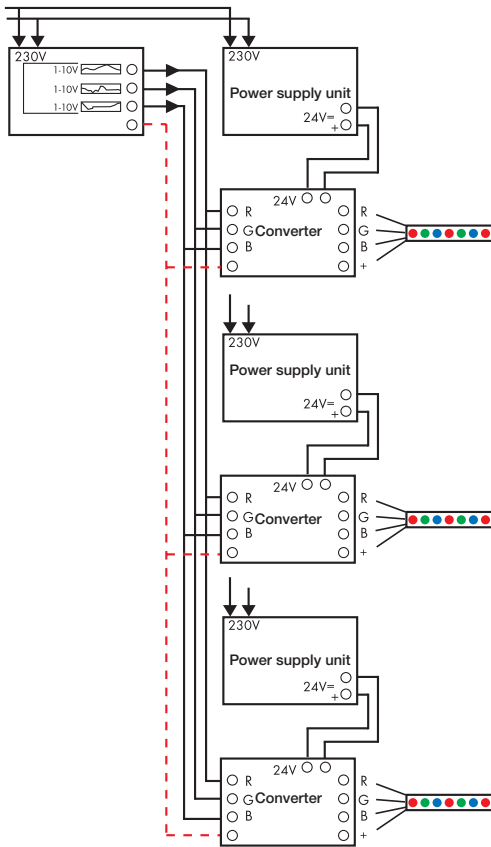

Application with LIM®2 controller, power supply unit 100W and 3-channel converter.
Connection of max. 50 converters possible.

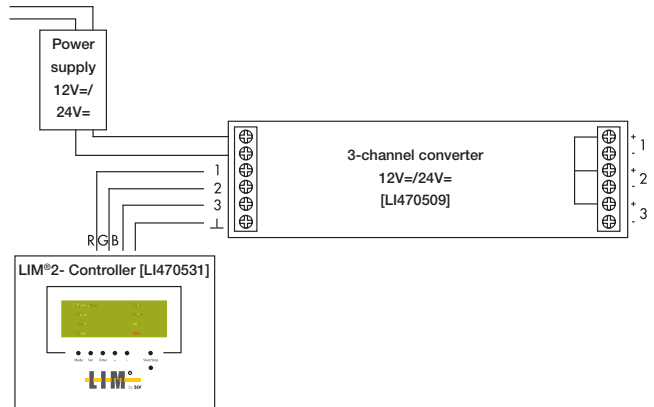

Application with EP1 dimmer 1-10V and 3-channel converter.

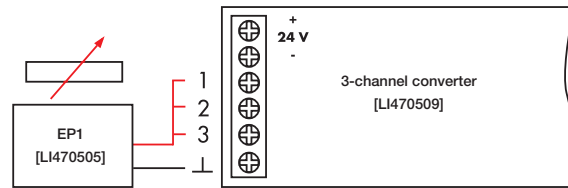

Close-up LIM®2 Controller

The LIM®2 4-channel controller enables setting and call of light colour or lighting level on keystroke.

Four groups of fittings with digital controllers for a control voltage of 1-10 Volt [e.g. fluorescent lamps, low-voltage halogen or LED applications] can be controlled.

Four sequence programmes are already pre-programmed in the system. Four additional programmes with eight lighting scenes can be programmed at will.

Due to the selectable holding and cross-fade times, dynamic cycles of the set lighting scenes are possible. Further features are a panic set-up, external gate input, variable time intervals and many more.

A convenient system that does not require system knowledge and can easily be handled by laymen.

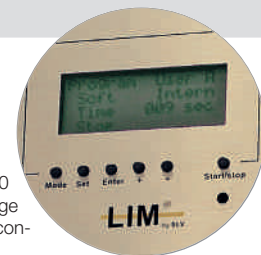

PWM CONVERTER 1-CHANNEL 12V=/24V=



Description	Voltage primary	Voltage secondary	Output wattage	Specification	Length in cm	Width in cm	Height in cm	Item no.
PWM-Converter 1-channel	12V=	12V=	50W max.	ta: 50°C/tc: 70°C	17,0	4,0	3,0	LI470550
	24V=	24V=	100W max.					

For dimming 12V= and 24V= single-colour strip applications. Independent converter.
Control voltage: 1-10V. Output: 4,1A

PWM CONVERTER 3-CHANNEL 12V=/24V=



Description	Voltage primary	Voltage secondary	Output wattage	Specification	Length in cm	Width in cm	Height in cm	Item no.
PWM-Converter 3-channel	12V=	12V=	16,6W	ta: 50°C/tc: 70°C	17,0	4,0	3,0	LI470509
	24V=	24V=	33,3W					

For controlling 12V= und 24V=, among others for RGB strips. Independent converter.
Control voltage: 3x 1-10V. Output: 3x 1,4A max.

EP1 DIMMER 1-10V

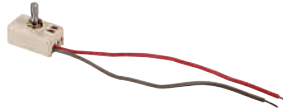

Description	Wattage	Length in cm	Width in cm	Height ¹ in cm	Height ² in cm	Axis Ø in cm	Weight in kg	Item no.
EP1 Dimmer 1-10V	10W max.	2,3	3,9	2,0	3,6	0,6	0,04	LI470505

For connecting with controllers with 1-10V control voltage.

LIM[®]2 CONTROLLER



Description	Voltage	Control voltage	Width in cm	Height in cm	Depth in cm	Colour	Item no.
LIM [®] 2 Controller	230V~	4x 1-10V	11,7	3,7	9,7	alu natural	LI470531

Accessories/Included: Flush-mounted housing [incl.], IR receiver on housing front [incl.].
With LCD display. Optionally controllable via remote control [LI470530]. Flush-mounted installation possible. Short-circuit-proof.

REMOTE CONTROL for LIM[®]2 Control



Description	Accessories/Included	Length in cm	Width in cm	Height in cm	Item no.
Remote Control	2x AA 1,5V batteries [excl.]	17,8	4,3	2,0	LI470530

Infrared remote control for controlling the LIM[®]2 Controller [LI470531].

LED POWER SUPPLY UNIT 60W, 12V=, dimmable



Description	Voltage secondary	Output wattage per channel	Specification	Length in cm	Width in cm	Height in cm	Item no.
LED power supply unit 60W dimmable	12V=	3x 20W	ta: 50°C/tc: 75°C	19,0	13,0	3,5	LI470539

Dimmable with EP1 dimmer [LI470505] or LIM[®]2 Controller [LI470531]. Dimming range: 0%-100%.
Control voltage: 3x 1-10V. Output: 3x 1,66A max.

LED POWER SUPPLY UNIT 100W, 24V=, dimmable



Description	Voltage primary	Voltage secondary	Output wattage per channel	Specification	Length in cm	Width in cm	Height in cm	Item no.
LED power supply unit 100W dimmable	230V~	24V=	33W	ta: 50°C/tc: 70°C	19,0	13,0	3,5	LI470540

Dimmable with EP1 dimmer [LI470505] or LIM[®]2 Controller [LI470531]. Dimming range: 0%-100%.
Control voltage: 3x 1-10V. Output: 3x 1,4A max.

POWER LIM®2 RGB MASTER CONTROL 24V=



Description	Voltage primary	Voltage secondary	Output wattage per channel	Specification	Power factor	Length in cm	Width in cm	Height in cm	Item no.
Master Control	230V~	24V=	3x 20W	ta: 50°C/tc: 60°C	0,95	18,5	13,0	3,5	LI470581

Accessories/Included: Built-in power supply unit 60W [incl.]. Secondary connection lead L: 30 m max.
Can be extended with up to 9 Slave controls.

All constant voltage and constant current devices of this range are compatible and connectable.

POWER LIM®2 RGB SLAVE CONTROL 24V=



Description	Voltage primary	Voltage secondary	Output wattage per channel	Specification	Power factor	Length in cm	Width in cm	Height in cm	Item no.
Slave Control	230V~	24V=	3x 20W	ta: 50°C/tc: 60°C	0,95	18,5	13,0	3,5	LI470582

Accessories/Included: Built-in power supply unit 60W [incl.]. Control connection lead: 1,2 m [incl.] Secondary connection lead L: 30 m max.
Control connection lead cannot be extended. For expansion of the Master Control [LI470581].

All constant voltage and constant current devices of this range are compatible and connectable.

POWER LIM®2 RGB MASTER CONTROL 350mA



Description	Voltage primary	Constant current secondary	Output wattage per channel	Specification	Power factor	Length in cm	Width in cm	Height in cm	Item no.
Master Control	230V~	350mA	3x 7W	ta: 50°C/tc: 60°C	0,95	18,5	13,0	3,5	LI470583

Accessories/Included: Built-in controller for 1W PowerLED, 21W max. [incl.]. Secondary connection lead L: 20 m max.
Can be extended with up to 9 Slave controls.

The first 2 Slave controls can be fed with the power supply of the Master device.

All constant voltage and constant current devices of this range are compatible and connectable.

POWER LIM®2 RGB SLAVE CONTROL 350mA



Description	Voltage primary	Constant current secondary	Output wattage per channel	Specification	Power factor	Length in cm	Width in cm	Height in cm	Item no.
Slave Control	24V=	350mA	3x 7W	ta: 50°C/tc: 65°C	0,95	17,5	7,8	3,5	LI470584

Accessories/Included: Power supply unit [excl.], control connection lead L: 1,2 m [incl.]. Secondary connection lead L: 20 m max.
Control connection lead cannot be extended. For expansion of the Master Control [LI470583].

All constant voltage and constant current devices of this range are compatible and connectable.

Max. 5x 1W PowerLED, max. 21W.

REMOTE CONTROL for Power LIM®2 Master control



Description	Length in cm	Width in cm	Height in cm	Item no.
Remote Control	17,8	4,8	1,9	LI470520

Accessories/Included: IR receiver [incl.], batteries [excl.]

Infrared remote control for controlling the Power LIM®2 Master controls [LI470581/-3].

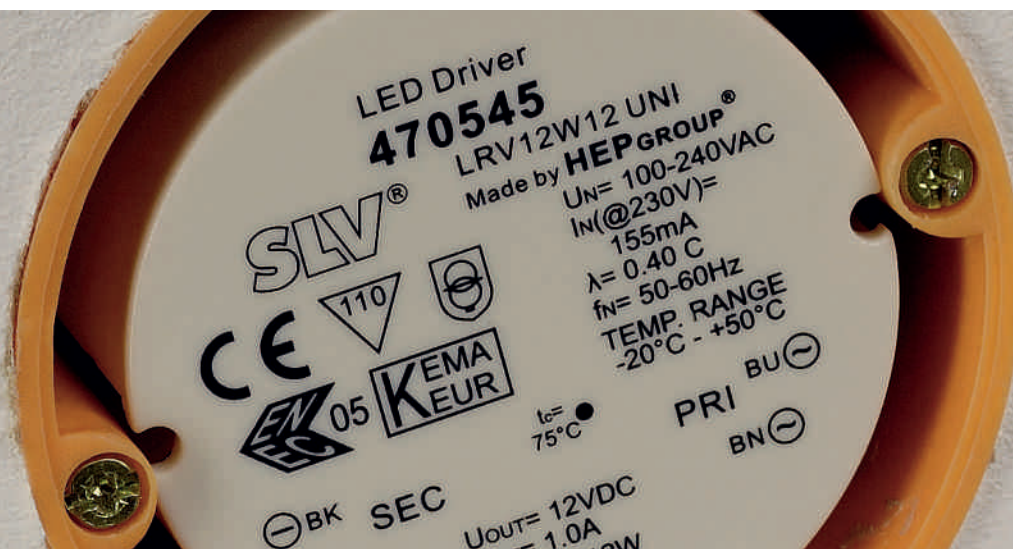

SCHEMATIC DIAGRAM

Application with Easy LIM® and power supply unit.

Easy LIM® LED controller with built-in PWM controller, 8 pre-set programmes and times, memory function, connection for external keys, connection to 12V= or 24V= power supply unit for LED. Max. load 4A total. For a wattage >50W the feed-in must be renewed.

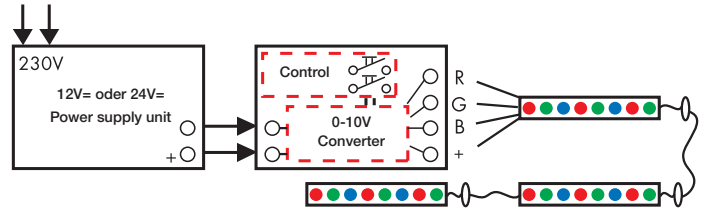

EASY LIM® RF MINI RGB MASTER CONTROL

Radio, 12V=/24V=, 3-channel

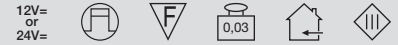

Description	Voltage primary	Voltage secondary	Output wattage per channel	Specification	Length in cm	Width in cm	Height in cm	Item no.
RGB Master Control Radio	12V=	12V=	16,5W	ta: 50°C/tc: 70°C	3,3	1,2	0,5	LI470650
	24V=	24V=	33W					

Accessories/Included: Remote control incl. [L/W/H: 8,6/4,0/0,65 cm], coverage 15 m. Battery CR2025 [excl.]
19 pre-set programmes, 20 pre-set static colours, 5 dimming stages, 10 speed levels, stand-by function.

EASY LIM® RF MINI RGB SLAVE

Radio, 12V=/24V=, 3-channel



Description	Voltage primary	Voltage secondary	Output wattage per channel	Specification	Length in cm	Width in cm	Height in cm	Item no.
RGB Slave Control Radio	12V=	12V=	16,5W	ta: 50°C/tc: 70°C	3,3	1,2	0,5	LI470651
	24V=	24V=	33W					

To extend the Easy LIM® RF Mini Master Control [LI470650].

EASY LIM® RF MINI SINGLE-COLOUR MASTER CONTROL

Radio, 12V=/24V=



Description	Voltage primary	Voltage secondary	Output wattage per channel	Specification	Length in cm	Width in cm	Height in cm	Item no.
Single-Colour Dimmer, Master Control Radio	12V=	12V=	50W	ta: 50°C/tc: 70°C	3,3	1,2	0,5	LI470660
	24V=	24V=	100W					

Accessories/Included: Remote control incl. [L/W/H: 8,6/4,0/0,65 cm], coverage 15 m. Battery CR2025 [excl.]
8 pre-set dynamic programmes, 10 speed levels, 10 brightness levels, stand-by function.

EASY LIM® RF MINI SINGLE-COLOUR SLAVE

Radio, 12V=/24V=, 1-channel

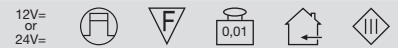

Description	Voltage primary	Voltage secondary	Output wattage per channel	Specification	Length in cm	Width in cm	Height in cm	Item no.
Single-Colour Dimmer, Slave Control Radio	12V=	12V=	50W	ta: 50°C/tc: 70°C	3,3	1,2	0,5	LI470661
	24V=	24V=	100W					

To extend the Easy LIM® RF Mini Single-Colour Master Control [LI470660].

LED POWER SUPPLY UNIT SOCKET INSTALLATION

12W, 12V= / 24V=



Description	Voltage secondary	Output wattage	Specification	Power factor	Ø in cm	Height in cm	Item no.
LED Power Supply Unit Socket Installation 12W	12V=	0-12W	ta: 50°C/tc: 80°C	0,4	5,5	2,2	LI470545
	24V=						LI470546

Suitable for installation in sockets with Ø 68 mm. Short-circuit-proof.
Primary connection lead L: 12,5 cm/secondary connection lead L: 14,5 cm

LED WALL POWER SUPPLY

16W, 24V=



Description	Voltage secondary	Output wattage	Specification	Length in cm	Width in cm	Height in cm	Item no.
LED Wall Power Supply 16W	24V=	16W	ta: 50°C/tc: 70°C	8,8	4,2	9,1	LI470571

LED POWER SUPPLY UNIT 12W, 12V=/24V=

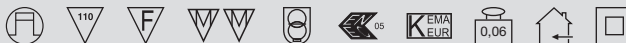

230V~
12V=
230V~
24V=

Description	Voltage secondary	Output wattage	Specification	Power factor	Length in cm	Width in cm	Height in cm	Item no.
LED Power Supply Unit 12W	12V=	0-12W	ta: 50°C/tc: 85°C	0,4	8,5	4,0	2,2	LI470507
	24V=						2,3	

LED POWER SUPPLY UNIT 20W, 12V=/24V=



230V~
12V=
230V~
24V=

Description	Voltage secondary	Output wattage	Specification	Power factor	Length in cm	Width in cm	Height in cm	Item no.
LED Power Supply Unit 20W	12V=	0-20W	ta: 50°C/tc: 75°C	0,95	16,7	3,9	3,0	LI470541
	24V=						LI470542	

LED POWER SUPPLY UNIT 36W, 12V=/24V=



230V~
12V=
230V~
24V=

Description	Voltage secondary	Output wattage	Specification	Power factor	Length in cm	Width in cm	Height in cm	Item no.
LED Power Supply Unit 36W	12V=	0-36W	ta: 50°C/tc: 80°C	0,9	12,9	7,5	3,2	LI470543
	24V=		ta: 50°C/tc: 70°C					LI470544

LED POWER SUPPLY UNIT 60W, 12V=/24V=



230V~
12V=
230V~
24V=

Description	Voltage secondary	Output wattage	Specification	Power factor	Length in cm	Width in cm	Height in cm	Item no.
LED Power Supply Unit 60W	12V=	0-60W	ta: 50°C/tc: 70°C	0,95	18,2	8,8	3,5	LI470508
	24V=		LI470506					

LED POWER SUPPLY UNIT 100W, 24V=



Description	Voltage secondary	Output wattage	Specification	Power factor	Length in cm	Width in cm	Height in cm	Item no.
LED Power Supply Unit 100W	24V=	0-100W	ta: 50°C/tc: 70°C	0,95	18,2	8,8	3,5	LI470500

LED POWER SUPPLY UNIT 150W, 24V=



± IP-protected



Description	Voltage secondary	Output wattage	Specification	Power factor	Length in cm	Width in cm	Height in cm	Item no.
LED Power Supply Unit 150W	24V=	0-150W	ta: 50°C/tc: 70°C	0,98	23,4	11,4	4,9	LI470548

Short-circuit-proof. Output: 1x 6,25A max.

LED POWER SUPPLY UNIT 60W, 12V=, dimmable



Description	Voltage secondary	Output wattage per channel	Specification	Length in cm	Width in cm	Height in cm	Item no.
LED Power Supply Unit 60W dimmable	12V=	3x 20W	ta: 50°C/tc: 75°C	19,0	13,0	3,5	LI470539

Dimmable with EP1 dimmer [LI470505] or LIM®2 Controller [LI470531]. Dimming range: 0%-100%.

Control voltage: 3x 1-10V. Output: 3x 1,66A max.

LED POWER SUPPLY UNIT
100W, 24V=, dimmable



Description	Voltage primary	Voltage secondary	Output wattage per channel	Specification	Length in cm	Width in cm	Height in cm	Item no.
LED Power Supply Unit 100W dimmable	230V~	24V=	33W	ta: 50°C/tc: 70°C	19,0	13,0	3,5	LI470540

Dimmable with EP1 dimmer [LI470505] or LIM#2 Controller [LI470531]. Dimming range: 0%–100%.
Control voltage: 3x 1–10V. Output: 3x 1,4A max.

TCI LED POWER SUPPLY UNIT
20W, 24V=, dimmable



Flat build



Description	Voltage primary	Voltage secondary	Output wattage per channel	Specification	Length in cm	Width in cm	Height in cm	Item no.
LED Power Supply Unit 20W dimmable	220–240V~	24V=	20W	ta: 50°C/tc: 80°C	14,6	5,5	1,9	LI470547

Dimmable with EP1 dimmer [LI470505].

LED DRIVER 3W, 350mA



Description	Constant current secondary	Wattage	Number of LEDs	Specification	Power factor	Length in cm	Width in cm	Height in cm	Item no.
LED driver 3W	350mA	1-3W	1-3 LED 1W	ta: 50°C/tc: 70°C	0,4	5,5	3,9	2,0	LI464108

With strain-relief. Fits in connection box [LI229260].

LED DRIVER 3W, 350mA, with mini socket

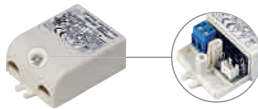

Description	Constant current secondary	Wattage	Number of LEDs	Specification	Power factor	Length in cm	Width in cm	Height in cm	Item no.
LED driver 3W	350mA	1-3W	1-3 LED 1W	ta: 50°C/tc: 70°C	0,4	5,6	3,9	2,0	LI464107

With socket for mini plug. With strain-relief. Fits in connection box [LI229260]. Recommended for fittings with mini plug.

LED DRIVER 3W, 700mA



Description	Constant current secondary	Wattage	Number of LEDs	Specification	Power factor	Length in cm	Width in cm	Height in cm	Item no.
LED driver 3W	700mA	1-3W	1 LED 3W	ta: 50°C/tc: 70°C	0,4	5,5	4,0	2,0	LI464200

With strain-relief. Fits in connection box [LI229260].

LED DRIVER 8W, 350mA



Description	Constant current secondary	Wattage	Number of LEDs	Specification	Power factor	Length in cm	Width in cm	Height in cm	Item no.
LED driver 8W	350mA	1-9W	1-6 LED 1W	ta: 50°C/tc: 70°C	0,4	8,5	4,1	2,2	LI464109

Independent converter. Short-circuit-proof.

LED DRIVER 8W, 480mA



Description	Constant current secondary	Wattage	Number of LEDs	Specification	Power factor	Length in cm	Width in cm	Height in cm	Item no.
LED driver 8W	480mA	1-8W	1 LED	ta: 50°C/tc: 70°C	0,4	8,5	4,04	2,2	LI464120

Diameter connection lead: 0,75-1,5 cm. Short-circuit-proof.

LED DRIVER 9W, 350mA



Description	Wattage	Specification	Power factor	Ø in cm	Height in cm	Item no.
LED driver 9W	5,6 - 9,1W	ta: 50°C/tc: 70°C	0,9	5,5	2,2	LI464130

Not dimmable. Short-circuit-proof.
Suitable for installation in switch sockets with Ø>68 mm.

LED DRIVER 9W, 500mA



Description	Constant current secondary	Wattage	Specification	Power factor	Length in cm	Width in cm	Height in cm	Item no.
LED driver 9W	500mA	6-9W	ta: 50°C/tc: 85°C	0,9	6,5	3,9	2	LI464091

Short-circuit-proof.

LED DRIVER 9W, 700mA



Description	Wattage	Specification	Power factor	Ø in cm	Height in cm	Item no.
LED driver 9W	5 - 8,9W	ta: 50°C/tc: 85°C	0,9	5,5	2,2	LI464132

Not dimmable. Short-circuit-proof.
Suitable for installation in switch sockets with Ø>68 mm.

LED DRIVER 10W, 700mA, dimmable



Description	Constant current secondary	Wattage	Specification	Power factor	Length in cm	Width in cm	Height in cm	Item no.
LED driver 10W dimmable	700mA	3-10W	ta: 50°C/tc: 80°C	0,95	12,0	4,5	2,0	LI464001

Dimming range: 25%-100%

LED DRIVER 12W, 350mA



Description	Constant current secondary	Wattage	Specification	Power factor	Length in cm	Width in cm	Height in cm	Item no.
LED driver 12W	350mA	6-12W	ta: 50°C/tc: 75°C	0,95	16,7	3,9	3,0	LI464110

With strain-relief. Fits in transformer box IP67 [LI229261]. With socket for mini plug [LI111850/-60].

LED DRIVER 12W, 700mA



Description	Constant current secondary	Wattage	Specification	Power factor	Length in cm	Width in cm	Height in cm	Item no.
LED driver 12W	700mA	6-12W	ta: 50°C/tc: 75°C	0,95	16,7	3,9	3,0	LI464202

With strain-relief. With socket for mini plug [LI111850/-60]

LED DRIVER 18W, 350mA



Description	Constant current secondary	Wattage	Specification	Power factor	Length in cm	Width in cm	Height in cm	Item no.
LED driver 18W	350mA	10-18W	ta: 50°C/tc: 70°C	0,95	15,3	6,7	3,5	LI464111

With strain-relief. With socket for mini plug [LI111850/-60]

LED DRIVER 18W, 700mA



Description	Constant current secondary	Wattage	Specification	Power factor	Length in cm	Width in cm	Height in cm	Item no.
LED driver 18W	700mA	10-18W	ta: 50°C/tc: 70°C	0,95	15,3	6,7	3,5	LI464201

With strain-relief. With socket for mini plug [LI111850/-60]

LED DRIVER 40W, 700mA



Description	Constant current secondary	Wattage	Specification	Power factor	Length in cm	Width in cm	Height in cm	Item no.
LED driver 40W	700mA	20 - 40W	ta: 50°C/tc: 85°C	0,9	16,7	4,6	3	LI464163

Independent converter. Short-circuit-proof.

LED DRIVER 40W, 700mA



Description	Constant current secondary	Wattage	Specification	Power factor	Length in cm	Width in cm	Height in cm	Item no.
LED driver 40W	700mA	40W	ta: 50°C/tc: 70°C	0,9	12,9	7,5	3,2	LI464168

Short-circuit-proof.

LED DRIVER 40W, 1000mA



Description	Constant current secondary	Wattage	Specification	Power factor	Length in cm	Width in cm	Height in cm	Item no.
LED driver 40W	1000mA	40W	ta: 50°C/tc: 70°C	0,9	12,9	7,5	3,2	LI464170

Short-circuit-proof.

LED DRIVER 40W, 700mA, dimmable



Description	Constant current secondary	Wattage	Specification	Power factor	Length in cm	Width in cm	Height in cm	Item no.
LED driver 40W	700mA	40W	ta: 50°C/tc: 70°C	0,9	12,9	7,5	3,2	LI464174

Short-circuit-proof. Dimmable with EP1 dimmer [LI470505].

LED DRIVER 40W, 1000mA, dimmable



Description	Constant current secondary	Wattage	Specification	Power factor	Length in cm	Width in cm	Height in cm	Item no.
LED driver 40W	1000mA	40W	ta: 50°C/tc: 70°C	0,9	12,9	7,5	3,2	LI464176

Short-circuit-proof. Dimmable with EP1 dimmer [LI470505].

LED DRIVER 36W, 700mA



Description	Constant current secondary	Wattage	Specification	Power factor	Length in cm	Width in cm	Height in cm	Item no.
LED driver 36W	700mA	36W	ta: 40°C/tc: 80°C	0,95	16,6	5,2	2,4	LI464803

LED DRIVER 40W, 1050mA, dimmable



Description	Constant current secondary	Wattage	Specification	Power factor	Length in cm	Width in cm	Height in cm	Item no.
LED driver 40W	1050mA	40W	ta: 50°C/tc: 80°C	0,95	16,6	5,2	2,4	LI464804

TCI LED DRIVER 0-50W, 350-1050mA, DALI dimmable



Description	Constant current secondary	Wattage	Specification	Power factor	Length in cm	Width in cm	Height in cm	Item no.	
	LED driver DALI dimmable	350mA							25W max.
		500mA							35W max.
		550mA							39W max.
		650mA							46W max.
700mA/750mA/850mA/900mA/1050mA		50W max.							

Constant current variably adjustable by toggle switch.

TCI LED DRIVER 11W, 700mA



↳ Slim build



Description	Constant current secondary	Wattage	Specification	Power factor	Length in cm	Width in cm	Height in cm	Item no.
LED driver 11W	700mA	11W	ta: 50°C/tc: 80°C	0,6	15,8	2,2	1,9	LI464030

TCI LED DRIVER 15W, 350mA



↳ Slim build



Description	Constant current secondary	Wattage	Specification	Power factor	Length in cm	Width in cm	Height in cm	Item no.
LED driver 15W	350mA	15W	ta: 50°C/tc: 80°C	0,6	15,8	2,2	1,9	LI464031

LED DRIVER 10W, 350mA, dimmable



Description	Constant current secondary	Wattage	Specification	Power factor	Length in cm	Width in cm	Height in cm	Item no.
LED driver 10W	350mA	5,95 - 10,15W	ta: 50°C/tc: 75°C	0,9	8,5	4,1	2,2	LI464140

Independent converter. Short-circuit-proof.
Dimmable with Triac dimmer, leading- or trailing-edge dimmer. We are happy to provide you with a dimmer compatibility list.

LED DRIVER 11W, 350mA, dimmable



Description	Constant current secondary	Wattage	Specification	Power factor	Length in cm	Width in cm	Height in cm	Item no.
LED driver 11W dimmable	350mA	1-11W	ta: 50°C/tc: 70°C	0,4	20,0	4,3	3,9	LI464112

With strain-relief. Dimmable with EP1 dimmer [LI470505].

LED DRIVER 15W, 350mA, dimmable



Description	Constant current secondary	Wattage	Specification	Power factor	Length in cm	Width in cm	Height in cm	Item no.
LED driver 15W	350mA	9,1 - 15W	ta: 50°C/tc: 80°C	0,9	8,5	4,1	2,2	LI464143

Independent converter. Short-circuit-proof.
Dimmable with Triac dimmer, leading- or trailing-edge dimmer. We are happy to send you a dimmer compatibility list.

LED DRIVER 15W, 500mA, dimmable



Description	Constant current secondary	Wattage	Specification	Power factor	Length in cm	Width in cm	Height in cm	Item no.
LED driver 15W	500mA	9 - 15W	ta: 50°C/tc: 80°C	0,9	8,5	4,1	2,2	LI464144

Independent converter. Short-circuit-proof.
Dimmable with Triac dimmer, leading- or trailing-edge dimmer. We are happy to send you a dimmer compatibility list.

LED DRIVER 18W, 350mA, dimmable



Description	Constant current secondary	Wattage	Specification	Power factor	Length in cm	Width in cm	Height in cm	Item no.
LED driver 18W	350mA	13 - 18W	ta: 50°C/tc: 70°C	0,9	15,3	6,7	3,1	LI464150

Independent converter. Short-circuit-proof.
Dimmable with Triac dimmer, leading- or trailing-edge dimmer. We are happy to send you a dimmer compatibility list.

LED DRIVER 30W, 700mA, dimmable



Description	Constant current secondary	Wattage	Specification	Power factor	Length in cm	Width in cm	Height in cm	Item no.
LED driver 30W dimmable	700mA	13-30W	ta: 50°C/tc: 85°C	0,95	18,0	4,5	2,8	LI464002

Dimming range: 25%–100%

MULTI-WAY CONNECTOR, 350mA 3 outlets

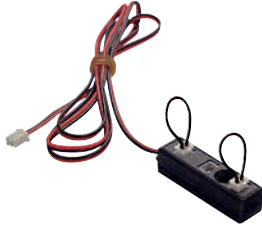

Description	Colour	Current load	Connection lead L in m	Length in cm	Width in cm	Height in cm	Item no.
Multi-way connector 3 outlets	black	350mA max.	1,0	5,2	1,4	1,3	LI111850

Series connection. 3 outlets incl. 2 bridges.

MULTI-WAY CONNECTOR, 350mA 6 outlets

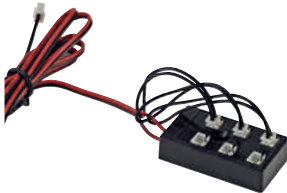

Description	Colour	Current load	Connection lead L in m	Length in cm	Width in cm	Height in cm	Item no.
Multi-way connector 6 outlets	black	350mA max.	1,5	5,2	3,0	1,3	LI111860

Series connection. 6 outlets incl. 3 bridges.

CABLE EXTENSION for products with 350mA plug



Description	Connection lead L in m	Wattage	Operation voltage	Weight in kg	Item no.
Cable Extension 350mA	1,0	350mA max.	determined by ballast	0,02	LI111861
	2,0			0,03	LI111862

Note: Max. length for the extension is 2 m.

MULTI-WAY CONNECTOR, 700mA 3 outlets

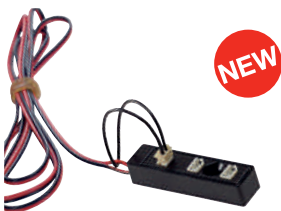
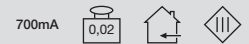

Description	Colour	Current load	Connection lead L in m	Length in cm	Width in cm	Height in cm	Item no.
Multi-way Connector, 700mA, 3 outlets	black	700mA max.	1,0	5,5	1,4	1,2	LI111830

Series connection. 3 outlets incl. bridge. 50V max.

MULTI-WAY CONNECTOR, 700mA 6 outlets

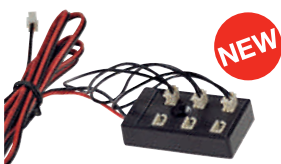

Description	Colour	Current load	Connection lead L in m	Length in cm	Width in cm	Height in cm	Item no.
Multi-way Connector, 700mA, 6 outlets	black	700mA max.	1,5	5,1	2,9	1,2	LI111831

Series connection. 6 outlets incl. 3 bridges. 50V max.

CABLE EXTENSION, 700mA 1m | 2m



Description	Connection lead L in m	Weight in kg	Item no.
Cable Extension, 700mA	1,0	0,01	LI111832
	2,0	0,02	LI111833

Extension of the connection cable of products which are operated at 700mA. 50V max.

JUNCTION BOX for LED spots in series connection

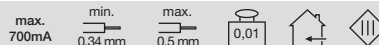

Description	Max. load		Voltage in DC	Connections in mm	Ø in cm	Height in cm	Permanent operation temperature in C	Item no.
Junction Box	0,34 mm ² /5A	0,5 mm ² /6A	60V max.	3x2/0,34-0,5	3,5	1,1	100° max.	LI410141

Series connection. 3 outlets [IN, OUT, LED]. Packaging unit: 2 pcs.

For easy connection of LED fittings with constant current max. 700mA to be connected in series.

ELECTRONIC BALLAST HID, 35W



Description	Voltage	Wattage	Specification	Power factor	Ignition voltage	Length in cm	Width in cm	Height in cm	Item no.
Electronic ballast 35W	230V~	35W	ta: 50°C/tc: 70°C	0,98	< 5 kv	20,0	4,3	3,9	LI470361

Secondary connection lead max. 2 m. For HID lamps 35W. To be used with HV connection leads only.

ELECTRONIC BALLAST HID, 2x 35W



35W

Description	Voltage	Wattage	Specification	Power factor	Ignition voltage	Length in cm	Width in cm	Height in cm	Item no.
Electronic ballast 2x 35W	230V~	2x 35W	ta: 55°C/tc: 80°C	0,95	< 4,5 kv	24,5	9,4	3,5	LI470200

For all HID lamps 2x 35W. Secondary connection lead L max. 1,5 m. To be used with HV connection leads only.

ELECTRONIC BALLAST HID, 35W, 70W, 150W

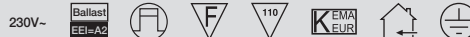

35W



70W



150W

Description	Voltage	Wattage	Specification	Power factor	Ignition voltage	Length in cm	Width in cm	Height in cm	Weight in kg	Item no.
Electronic ballast HID 35W	230V~	35W	ta: 50°C/tc: 70°C	0,95	< 5 kv	12,9	7,6	3,2	0,24	LI470360
Electronic ballast HID 70W		70W	ta: 50°C/tc: 75°C	0,98						LI470370
Electronic ballast HID 150W		150W	ta: 50°C/tc: 85°C	0,98						LI470380

Flicker-free light. Extension of the lamp's life span of up to 50%. Automatic shutdown in case of failing or missing lamp.

Secondary connection lead L max. 2 m. To be used with HV connection leads only.

CONNECTION LINE for HID applications



Description	Connection line L in m	Ignition-voltage-proof up to	Item no.
Connection Line HV	2,0	5 kv	LI961062

Note: For HID ballasts SO-2GMH2G-J 3x 1 mm².

Conventional transformers should be used to capacity by 80%. The transformers displayed here are to be dimmed with **leading-edge dimmers**. When being dimmed, a low operating sound may be audible. Please pay attention to the manufacturer's notes.

CONVENTIONAL TRANSFORMER MANTA 200, 300

230V~
12V~



200
VA

300
VA



Description	Voltage in AC/AC	Wattage	Secondary fuse	Ø in cm	Height in cm	Weight in kg	Colour	Item no.
Manta 200	230V/12V	200VA	1x 20A	20,0	8,0	2,75	chrome	LI455202
								silver-grey
Manta 300		300VA	2x 15A		9,0	3,9	chrome	LI455302
							silver-grey	LI455309

TRANSFORMER 105VA, 210VA

230V~
12V~



100
VA

200
VA



Description	Voltage in AC/AC	Wattage	Ø in cm	Height in cm	Weight in kg	Colour	Item no.
Toroidal transformer 100VA	230V/12V	105VA	12,5	9,5	1,7	chrome	LI138812
Toroidal transformer 200VA		210VA	13,5	11,5	2,7		LI138822

ARTE 300

230V~
12V~



300
VA



Description	Voltage in AC/AC	Wattage	Ø in cm	Height in cm	Colour	Item no.
Toroidal transformer Arte 300	230V/12V	300VA	16,0	9,5	chrome	LI167032
					silver-grey	LI167039

IP44 TRANSFORMER 10VA/12V~

230V~
12V~



10
VA



Description	Voltage in AC/AC	Wattage	Length in cm	Width in cm	Height in cm	Item no.
IP44 transformer 10VA	230V/12V	10VA	7,5	5	4,5	LI227140

Short-circuit-proof. Connection lead L: 2 m. No-load current 0,45A, no-load voltage 13,4V.

Accessories/ Included: Mains plug: Euro IP [incl.]

Primary connection lead L: 2 m, secondary connection lead L: 1 m

IP44 TRANSFORMER 60VA/12V~

230V~
12V~



60
VA



Description	Voltage in AC/AC	Wattage	Length in cm	Width in cm	Height in cm	Item no.
IP44 transformer 60VA	230V/12V	60VA	6,0	10,0	6,3	LI227160

Accessories/ Included: Mains plug: Euro IP [incl.]

Primary connection lead L: 2 m, secondary connection lead L: 1 m

IP44 TRANSFORMER 150VA/12V~

230V~
12V~



150
VA



Description	Voltage in AC/AC	Wattage	Length in cm	Width in cm	Height in cm	Item no.
IP44 transformer 150VA	230V/12V	150VA	8,0	11,0	7,5	LI227150

Accessories/ Included: Mains plug: Euro IP [incl.]

Primary connection lead L: 2 m, secondary connection lead L: 1 m

ROUND TRANSFORMER 20VA/12V~



Description	Voltage in AC/AC	Wattage	Specification	Ø in cm	Height in cm	Item no.
Round Transformer 20VA	230V/12V	20VA	ta: 40°C	5,0	6,5	LI451021

Primary connection lead L: 25 cm, secondary connection lead L: 25 cm. Short-circuit-proof.

ROUND TRANSFORMER 35VA/12V~



Description	Voltage in AC/AC	Wattage	Specification	Ø in cm	Height in cm	Item no.
Round Transformer 35VA	230V/12V	35VA	ta: 40°C	5,7	8,0	LI451022

Primary connection lead L: 30 cm, secondary connection lead L: 30 cm. Short-circuit-proof.

CONVENTIONAL TRANSFORMER 60VA/12V~



Description	Voltage in AC/AC	Wattage	Length in cm	Width in cm	Height in cm	Item no.
Conventional Transformer 60VA	230V/12V	60VA	6,0	10,0	6,3	LI451060

Accessories/Included: Primary fuse [incl.]

Primary connection lead L: 25 cm, secondary connection lead L: 25 cm

CONVENTIONAL TRANSFORMER 105VA/12V~



Description	Voltage in AC/AC	Wattage	Length in cm	Width in cm	Height in cm	Item no.
Conventional Transformer 105VA	230V/12V	105VA	11,0	7,5	8,0	LI451105

Accessories/Included: Primary fuse [incl.]

Primary connection lead L: 25 cm, secondary connection lead L: 25 cm

CONVENTIONAL TRANSFORMER 150VA/12V~



Description	Voltage in AC/AC	Wattage	Length in cm	Width in cm	Height in cm	Item no.
Conventional Transformer 150VA	230V/12V	150VA	8,0	11,0	8,0	LI451150

Accessories/Included: Primary fuse [incl.]

Primary connection lead L: 25 cm, secondary connection lead L: 25 cm

CONVENTIONAL TRANSFORMER 250VA/12V~



Description	Voltage in AC/AC	Wattage	Length in cm	Width in cm	Height in cm	Item no.
Conventional Transformer 250VA	230V/12V	250VA	9,0	13,0	10,5	LI451250

Accessories/Included: Primary fuse [incl.]

Primary connection lead L: 25 cm, secondary connection lead L: 25 cm

CONVENTIONAL TRANSFORMER 300VA/12V~



Description	Voltage in AC/AC	Wattage	Length in cm	Width in cm	Height in cm	Item no.
Conventional Transformer 300VA	230V/12V	300VA	9,0	13,0	11,0	LI451301

Accessories/Included: Primary fuse [incl.]

Primary connection lead L: 25 cm, secondary connection lead L: 25 cm

The electronic transformers displayed here are safety transformers in compact build. They are open-circuit- and short-circuit-proof as well as overload-protected. The electronic transformers in our range are to be dimmed with standard **trailing-edge dimmers**. Please pay attention to the manufacturers' notes. For electronic transformers a connection line length of 2 m must strictly not be exceeded because of stray radiation. Not suitable for rope systems.

MINI TRANSFORMER 1 60VA



Description	Voltage in AC/AC	Wattage	Specification	Power factor	Length in cm	Width in cm	Height in cm	Item no.
Mini Transformer 1	230V/12V	10-60VA	tc: 75°C/ta: 50°C	0,98 λ	10,5	3,3	2,2	LI461060

Reversible temperature rise switch. Secondary connection: 1 pair of screw terminals.

TCI ELECTRONIC TRANSFORMER 105VA



± Flat build



Description	Voltage in AC/AC	Wattage	Specification	Length in cm	Width in cm	Height in cm	Item no.
TCI Electronic Transformer	230V/12V	20-105VA	tc: 75°C/ta: 45°C	14,6	5,5	1,9	LI461320

ELECTRONIC TRANSFORMER 01 60VA



Description	Voltage in AC/AC	Wattage	Specification	Length in cm	Width in cm	Height in cm	Item no.
Electronic Transformer 01	230V/12V	10-60VA	tc: 70°C/ta: 50°C	15,1	3,6	2,7	LI461067

Reversible temperature rise switch. Secondary connection: 2 pairs of screw terminals.

ELECTRONIC TRANSFORMER 02 105VA



Description	Voltage in AC/AC	Wattage	Specification	Length in cm	Width in cm	Height in cm	Item no.
Electronic Transformer 02	230V/12V	20-105VA	tc: 80°C/ta: 50°C	16,6	3,9	3,3	LI461107

Reversible temperature rise switch. Secondary connection: 3 pairs of screw terminals.

ELECTRONIC TRANSFORMER 03 150VA



Description	Voltage in AC/AC	Wattage	Specification	Length in cm	Width in cm	Height in cm	Item no.
Electronic Transformer 03	230V/12V	50-150VA	tc: 85°C/ta: 50°C	16,6	3,9	3,3	LI461157

Reversible temperature rise switch. Secondary connection: 3 pairs of screw terminals.

ELECTRONIC TRANSFORMER 04 210VA



Description	Voltage in AC/AC	Wattage	Specification	Length in cm	Width in cm	Height in cm	Item no.
Electronic Transformer 04	230V/12V	50-210VA	tc: 75°C/ta: 50°C	20,0	4,3	3,9	LI461217

Reversible temperature rise switch. Secondary connection: 3 pairs of screw terminals.

PROFESSIONAL TRANSFORMER HOLE 70VA



Description	Voltage in AC/AC	Wattage	Specification	Power factor	Ø in cm	Depth in cm	Item no.
Professional Transformer Hole	230V/12V	10-70VA	tc: 70°C/ta: 50°C	0,98 λ	5,5	2,3	LI461050

Reversible temperature rise switch. Primary connection lead L: 15 cm/secondary connection lead L: 11 cm

OSRAM MOUSE 70VA



Description	Voltage in AC/AC	Wattage	Specification	Length in cm	Width in cm	Depth in cm	Item no.
Osram Mouse 70	230V/12V	20-70VA	tc: 80°C/ta: 50°C	10,8	5,2	3,3	LI461075

Secondary side: 1 pair of screw terminals, dimmable with trailing-edge and leading-edge dimmer.

OSRAM MOUSE 105VA



Description	Voltage in AC/AC	Wattage	Specification	Length in cm	Width in cm	Depth in cm	Item no.
Osram Mouse 105	230V/12V	35-105VA	tc: 85°C/ta: 50°C	10,8	5,2	3,3	LI461105

Secondary side: 2 pairs of screw terminals, dimmable with trailing-edge and leading-edge dimmer.

OSRAM MOUSE 150VA



Description	Voltage in AC/AC	Wattage	Specification	Length in cm	Width in cm	Depth in cm	Item no.
Osram Mouse 150	230V/12V	50-150VA	tc: 80°C/ta: 50°C	15,3	5,4	3,6	LI461155

Through-wiring, secondary side: 3 pairs of screw terminals, dimmable with trailing-edge and leading-edge dimmer.

CONNECTION BOX ROUND



Description	Cable Ø in mm	Ø in cm	Length in cm	Width in cm	Height in cm	Item no.
Connection Box round	9-14	11,5	15,5	15,5	4,6	LI229260

For outdoor wiring. Suitable for driver [LI464108/-200], see page 807.
2 outlets can be wired with thinner connection lines 6-9,5.

TRANSFORMER BOX IP67



Description	Cable Ø in mm	Length in cm	Width in cm	Height in cm	Item no.
Transformer Box IP67	6-13	29,5	4,5	6,0	LI229261

Suitable for electronic components with the dimensions: L/W/H: 18,5/4/3,5 cm, e.g. LED driver 12W [LI464110].

CONNECTION BOX IP68



Description	Cable Ø in mm	Ø in cm	Length in cm	Item no.
Connection Box IP68, 3-pole	6-12	2,7	11,5	LI228730
Connection Box IP68, 5-pole	8-17	3,2	13,0	LI228725

CONNECTION BOX IP67



Description	Cable Ø in mm	Length in cm	Width in cm	Height in cm	Item no.
Connection Box IP67	6-13	25,0	4,5	6,0	LI229262

IP68 CONNECTION BOX



Description	Cable Ø in mm	Length in cm	Width in cm	Height in cm	Item no.
Connection Box IP68	3x 6-11	11,0	6,4	3,0	LI228726

Connector for cables and connection lines, rated IP68.

IP68 CONNECTION BOX, 3-pole



Description	Cable Ø in mm	Ø in cm	Length in cm	Item no.
Connection Box IP68	2x 6-13	4,1	10,0	LI228724

Connector for cables and connection lines, rated IP68.

IP68 CONNECTION BOX FDM1, 4-pole



Description	Cable Ø in mm	Ø in cm	Length in cm	Item no.
Connection and Branch Tee IP68 FDM1	4x 5-14	7,2	16,0	LI229269

Connector for cables and connection lines, rated IP68.

Can be opened and re-used anytime. Completely waterproof - IP68.

Human acids- and corrosion-resistant. Can be applied for outdoor, duct and earth installations.



IP68 CONNECTION BOX FDM2, 4-pole



± Driver/transformer installation possible

Description	Cable Ø in mm	Ø in cm	Length in cm	Item no.
Connection and Branch Tee IP68 FDM2	4x 7-25	10,0	28,5	LI229268

Connector for cables and connection lines, rated IP68.

Can be opened and re-used anytime. Completely waterproof - IP68.

Human acids- and corrosion-resistant. Can be applied for outdoor, duct and earth installations.

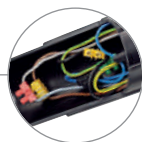

ENERGY PACK

230V~  IP54 



Description	Voltage in AC	Wattage	Length in cm	Width in cm	Height in cm	Earth spike L in cm	Item no.
Energy Pack, 4 safety sockets with flap lid	230V	16A max.	35,0	12,0	12,0	50,0	LI227000

Accessories/Included: Earth spike [incl.], mounting screws [incl.]
Transformers not suitable for outdoors can be placed in the energy pack.
3 outlets for metrical cable connections according to EN 50262 M 12 [cable Ø: 2,5–6,5 mm].
1 inlet for metrical cable connections according to EN 50262 M 25 [cable Ø: 9–17 mm].

4-OUTLET GARDEN SOCKET IP44, ready-to-plug

230V~    IP44 



Description	Voltage in AC	Connection lead length in m	Length in cm	Width in cm	Height in cm	Earth spike L in cm	Item no.
4 safety sockets with flap lid	230V	1,4	10,2	12,0	21,0	16,0	LI227001
		10					LI227002

Accessories/Included: Plastic earth spike [incl.], mains plug: IP safety plug [incl.]

MOTION SENSOR MICROWAVE IP44

230V~ t_a -15°C/+70°C   IP44 

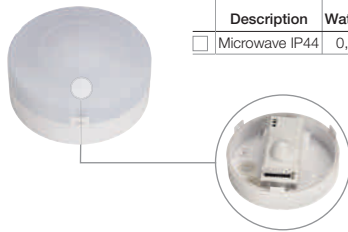

Description	Wattage	Ø in cm	Height in cm	Installation height in m	Power-on time in s/min	Coverage angle horizontal/vertical	Coverage distance in m	Material	Colour	Item no.
<input type="checkbox"/> Microwave IP44	0,5W	11,5	5,8	2,5-3,5	6/1, 3, 5, 10, 15	180°/180°	2/5/8/10	plastic	white	LI410871

Operating frequency: 5,8 GHz [ISM band], **Activation ambient brightness:** >10/100/300/2000 LUX
Nominal capacity: Incandescent lamp/halogen: 1200W/5A
Fluorescent lamp/LED: 300W/2,5A



MOTION SENSOR INFRARED IP44

230V~ t_a -10°C - +40°C    max. 11   IP44 



Description	Width in cm	Height in cm	Depth in cm	Power-on time	Coverage angle horizontal/vertical	Material	Colour	Item no.
<input type="checkbox"/> Motion Sensor Infrared IP44	6,5	9,5	10	10 s bis 4 min	180°/60°	plastic	white anthracite	LI410861 LI410865

Controllable twilight switch
Nominal capacity: Incandescent lamp/halogen: 1000W
Fluorescent lamp: 300W
LED: 100W



PVC CONNECTION LINE WITH TEXTILE COATING, 10 m



Description	Dimensions	Colour	Item no.
PVC Connection Line, H03VV-F, 3x 0,75 mm ²	10 m spool	black	LI961270
		white	LI961271
		orange	LI961274
		green	LI961275
		red	LI961276

Permissible ambient temperature: t_a 70°C



CLEAR CABLE, 10 m



Description	Dimensions	Item no.
Clear Cable isolated, PVC + PVC, 3x 0,75 mm ²	10 m spool	LI961250

STEEL ROPE SUSPENSION, incl. cable clips

230V~



Description	Ø in cm	Length in cm	Weight in kg	Item no.
Steel Rope Suspension	0,1	300,0	0,01	LI961036
		500,0	0,02	LI961037

mechanical load: 400N max.

STEEL ROPE, 0,75 mm²

Description	Ø in cm	Length in cm	Weight in kg	Item no.
Steel Rope, 0,75 mm ²	0,15	10000	0,5	LI961031

mechanical load: 40N max.

STOPPER for steel rope



Description	Ø in cm	Weight in kg	Item no.
Stopper	0,8	0,01	LI961034

Rope Ø: 2 mm max.

GU10 SOCKET

230V~





Description	Voltage	Connection lead L in cm	Weight in kg	Socket	Item no.
GU10 Socket 15	230V~	15,0	0,02	GU10	LI955135
GU10 Socket 60		60,0	0,035		LI955137

G6,35 HALOGEN SOCKET

12V~ 

Description	Ø in cm	Height in cm	Connection lead L in cm	Socket	Item no.
Halogen Socket 15	1,7	1,0	15,0	G6,35	LI955000
Halogen Socket 60			60,0		LI955020
Halogen Socket 120			120,0		LI955030

LV DISTRIBUTOR BOX 6-fold

12V~    

Description	Length in cm	Width in cm	Height in cm	Item no.
LV Distributor Box 6-fold	6,4	2,6	1,5	LI410140

50W max. per outlet. The max. load must, however, not exceed 250W.

LAMP PLIERS for MR16/GU10



Description	Material	Item no.
Lamp Pliers for MR16/GU10	stainless steel 304	LI470640



LAMPS

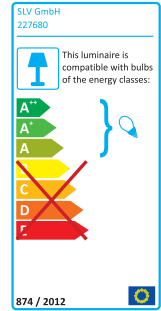
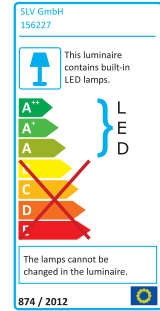

- The indicated energy efficiency categories comply with the European regulation No. 874/2012. The specification of the energy efficiency category for lamps is marked with EEC in this chapter. The energy labels regarding the individual items can be downloaded from www.slv.de.
- For the application of IRC or energy-saving lamps the maximum output of the fittings and the standard equivalent lamp must be noted. Tables can be found next to the lamps. Example: A fitting with a max. 50W standard lamp can only be equipped with a 35W energy-saving lamp.
- All lamps must be disposed of separately and do not belong in the domestic rubbish!
- Operation in open fittings without protection glass is permissible with low-pressure lamps only. Lamps with this sign  (standard IEC 357) are suitable for use in fittings without protection glass.
- Halogen lamps and metal-halide discharge lamps have a high operating temperature and can cause heating of the respective housing of fittings. The latter can therefore only be touched in cooled condition. Adjustable fittings or lamp heads which do not have an isolated adjustment handle or exceed the permissible housing temperature at the adjustment point during operation with a maximum lamp wattage must be mounted out of arm's reach. LED Retrofit lamps are available as low-temperature model to most of our halogen lamps. Suitable solutions can be found in this chapter.
- Low-voltage fittings can also be operated with LED Retrofit lamps in many cases. Due to specific transformer and LED technology not every combination of fittings with apparently suitable lamps is possible. If you have any questions regarding the compatibility, please find more information on www.slv.de or contact our sales team.
- The dimensions of the lamps always refer to the complete outward dimensions of a lamp, i.e. including the screw base.

HALOGEN LAMPS

<p>G4 QT9</p> <p>G6,35 QT12</p>	 822	<p>G9 QT14</p>	 822	<p>R7s 78 mm QT-DE12</p> <p>R7s 118 mm QT-DE12</p>	 822	<p>E14 C35 QC35 TC(...) SE</p>	 823
<p>GU5,3 QR-C51</p>	 823	<p>GU10 QPAR51 PAR20</p>	 823	<p>G53 QR111</p>	 824	<p>GU10 QPAR111</p>	 824



PROFESSIONAL LAMPS

<p>Precise™ ConstantColor™ GU5,3 QR-C51</p>  <p>823</p>	<p>Precise™ ConstantColor™ GX10 HIPAR51</p>  <p>826</p>	<p>Britespot GX10 QPAR111</p>  <p>826</p>	<p>GU6,5 HIT-TC Mini</p>  <p>825</p>
<p>G8,5 HIT-TC</p>  <p>825</p>	<p>G12 HIT-CE</p>  <p>825</p>	<p>Rx7s HIT-DE</p>  <p>826</p>	<p>E40 HIT-T</p>  <p>826</p>
<p>E27 HIE</p>  <p>826</p>	<p>E27 PAR20/-30/-38</p>  <p>824</p>		

LED LAMPS

<p>PHJ65-d Fortimo Twistable Octagon Top LED</p>  <p>827</p>	<p>G9 QT14</p>  <p>827</p>	<p>R7s 118 mm QT-DE12</p>  <p>827</p>	<p>GU5,3 QR-C51 GX5,3 QR-C51</p>  <p>828</p>
<p>GU10 QPAR51</p>  <p>828-830</p>	<p>G53 QR111</p>  <p>830-831</p>	<p>GU10 QPAR111</p>  <p>831-832</p>	<p>GX53 TCR-TSE</p>  <p>834</p>
<p>E14 C35</p>  <p>832</p>	<p>E27</p>  <p>827, 832-833</p>	<p>E27 PAR30</p>  <p>834</p>	<p>G13 T26</p>  <p>834</p>

ENERGY-SAVING LAMPS

<p>E14 TC(...) SE</p>  <p>835</p>	<p>E27 TC(...) SE PAR38</p>  <p>835</p>	<p>2G11 TC-L</p>  <p>836</p>	<p>G23 TC-S</p>  <p>836</p>	<p>G24d-1/-2/-3 TC-D</p>  <p>836</p>
<p>G24d-1/-2/-3 TC-D</p>  <p>836</p>	<p>G24Q-1/-2/-3 TC-DE</p>  <p>836</p>	<p>2G11 TC-L</p>  <p>836</p>	<p>G5 T16 G13 T26</p>  <p>837</p>	<p>2GX13 T16-R G10q T29-R</p>  <p>837</p>
		<p>GX53 TCR-TSE</p>  <p>836</p>		



PIN SOCKET LOW-PRESSURE G4 Halogen

12V-



Socket	Wattage	Energy consumption	Colour temperature	Luminous flux	Colour rendering	Energy efficiency class	Item no.
G4	5W	6kWh/1000h	2700K	50lm	CRI 100	EEC=C	LI512205
	10W	11kWh/1000h		120lm			LI512210
	20W	22kWh/1000h		330lm			LI512220

PIN SOCKET LOW-PRESSURE G6,35 Halogen

12V-



Socket	Wattage	Energy consumption	Colour temperature	Luminous flux	Colour rendering	Energy efficiency class	Item no.
G6,35	35W	38kWh/1000h	2700K	595lm	CRI 100	EEC=C	LI512235
	50W	53kWh/1000h		900lm			LI512250

OSRAM HALOPIN ECO QT Quartz halogen

230V-

OSRAM



Socket	Wattage	Energy consumption	Colour temperature	Luminous flux	Colour rendering	Energy efficiency class	Item no.	
G9	20W	± 25W	20kWh/1000h	2700K	235lm	CRI 100	EEC=D	LI519450
	33W	± 40W	33kWh/1000h		460lm			LI519451
	48W	± 60W	48kWh/1000h	2800K	740lm			LI519452

QT-DE 78 mm/118 mm PHILIPS PLUSLINE ES Quartz halogen

230V-

PHILIPS



Socket	Wattage	Energy consumption	Colour temperature	Luminous flux	Colour rendering	Energy efficiency class	Item no.	
R7s 78 mm	48W	± 60W	40kWh/1000h	2900K	750lm	CRI 100	EEC=D	LI519230
	80W	± 100W	80kWh/1000h		1415lm			LI519231
R7s 118 mm	120W	± 150W	120kWh/1000h	2900K	2220lm			CRI 100
	160W	± 200W	160kWh/1000h		3100lm	LI519241		

QT-DE 118 mm Quartz halogen

230V-



Socket	Wattage	Energy consumption	Colour temperature	Luminous flux	Colour rendering	Energy efficiency class	Item no.
R7s 118 mm	100W	100kWh/1000h	2900K	1800lm	CRI 100	EEC=D	LI519221



ECO-HALOGEN E14 Halogen



Socket	Wattage	Energy consumption	Ø in cm	Length in cm	Colour temperature	Luminosity	Luminous flux	Colour rendering	Energy efficiency class	Item no.
E14	30W	30kWh/1000h	3,5	10,4	2700K		405lm	CRI 100	EEC=D	LI519500

DIRECT BEAM MR16 Halogen



Socket	Wattage	Energy consumption	Ø in cm	Colour temperature	Luminosity	Luminous flux	Colour rendering	Beam angle	Energy efficiency class	Item no.	
GU5,3	10W	11kWh/1000h	5,0	2900K	260cd	90lm	CRI 100	35°	EEC=B	-	LI536138
	20W	22kWh/1000h			750cd	225lm		30°		BAB	LI536240
	35W	38kWh/1000h			1170cd	450lm		35°	EEC=C	FMW	LI536338
	50W	53kWh/1000h			2100cd	680lm		30°		EXN	LI536540

Metal-coated for minor heat development on rear side of reflector.

GU10 Quarz-Halogen



Socket	Wattage	Energy consumption	Ø in cm	Colour temperature	Luminosity	Luminous flux	Colour rendering	Beam angle	Energy efficiency class	Item no.	
GU10	35W	38kWh/1000h	5,0	2700K	500cd	180lm	CRI 100	25°	EEC=E	▼	LI575520
	50W	50kWh/1000h			1100cd	300lm				50°	EEC=D
					500cd					▼	LI575535

Reflector alu-coated.

GU10 ECO Quarz-Halogen



Socket	Wattage	Energy consumption	Ø in cm	Length in cm	Colour temperature	Luminosity	Luminous flux	Colour rendering	Energy efficiency class	Item no.	
GU10	25W	25kWh/1000h	5,0	5,5	2800K	750cd	150lm	CRI 100	EEC=D	▼	LI575360
	35W	35kWh/1000h				1200cd	280lm			▼	LI575370

PAR20 GU10 Quarz-Halogen



Socket	Wattage	Energy consumption	Ø in cm	Length in cm	Colour temperature	Luminosity	Luminous flux	Colour rendering	Energy efficiency class	Item no.
GU10	75W	75kWh/1000h	6,4	6,4	2700K	1750cd	680lm	CRI 100	EEC=D	▼ LI575682



HALOSPOT111 ECO Low-pressure halogen

12V-

OSRAM



Socket	Wattage	Energy consumption	Ø in cm	Colour temperature	Luminosity	Luminous flux	Colour rendering	Beam angle	Energy efficiency class	Item no.	
G53	35W	± 50W	11,1	2900K	2250cd	440lm	CRI 100	6°	EEC=B	LI545512	
					4200cd			24°		LI545522	
	50W	± 75W		53kWh/1000h	3000K	3300cd		650lm		6°	LI545751
						5500cd				24°	LI545752
				2000cd						40°	LI545753

QRB111 Low-pressure halogen

12V-



Socket	Wattage	Energy consumption	Ø in cm	Colour temperature	Luminosity	Luminous flux	Colour rendering	Beam angle	Energy efficiency class	Item no.				
G53	20W	22kWh/1000h	11,1	2900K	4210cd	147lm	CRI 100	8°	EEC=D	LI543208				
					1020cd	152lm		24°		LI543224				
					350cd			45°		LI543245				
	35W	38kWh/1000h			1100cd	540lm		1340cd	330lm	CRI 100	8°	EEC=C	LI543308	
								2440cd	340lm		24°		LI543324	
								650cd	350lm		45°		LI543345	
								1850cd	530lm		8°		LI543508	
	50W	53kWh/1000h			1100cd	540lm		3140cd	540lm	CRI 100	24°	EEC=C	LI543524	
													45°	LI543545

ES111 Quartz halogen

230V-

SYLVANIA



Socket	Wattage	Energy consumption	Ø in cm	Colour temperature	Luminosity	Luminous flux	Colour rendering	Energy efficiency class	Item no.
GU10	75W	75kWh/1000h	11,1	2800K	3500cd	520lm	CRI 100	EEC=D	LI1575540

Reflector alu-coated with shade.

ES111 Quartz halogen

230V-



Socket	Wattage	Energy consumption	Ø in cm	Colour temperature	Luminosity	Luminous flux	Colour rendering	Energy efficiency class	Item no.
GU10	50W	50kWh/1000h	11,1	2700K	1000cd	230lm	CRI 100	EEC=E	LI1575652
	75W	75kWh/1000h			1600cd	430lm			LI1575672

Reflector alu-coated with shade.

Socket	Wattage	Energy consumption	Ø in cm	Colour temperature	Luminosity	Luminous flux	Colour rendering	Energy efficiency class	Item no.
GU10	50W	50kWh/1000h	11,1	4000K	1100cd	250lm	CRI 100	EEC=E	LI1575651
	75W	75kWh/1000h			1750cd	460lm			LI1575671

Reflector alu-coated. Neutral white light in light core centre, surrounded by a dichroic effect.

PAR20 E27 / PAR30 E27 / PAR38 E27 Halogen

230V-



Type	Socket	Wattage	Energy consumption	Ø in cm	Length in cm	Colour temperature	Luminosity	Luminous flux	Colour rendering	Beam angle	Energy efficiency class	Item no.
PAR20	E27	50W	50kWh/1000h	6,5	8,2	2700K	890cd	350lm	CRI 100	34°	EEC=D	LI1519725
		75W	75kWh/1000h				1550cd	675lm				LI1519727
PAR30	E27	75W	75kWh/1000h	9,5	9,3	2700K	1325cd	625lm	CRI 100	40°	EEC=D	LI1519737
		150W	150kWh/1000h				2310cd	1580lm				LI1519739
PAR38	E27	80W	80kWh/1000h	12,4	13,6	2700K	1800cd	670lm	CRI 100	30°	EEC=D	LI1519760

PAR30
PAR38



HIT-TC MINI GU6,5 HIT halogen metal halide



PHILIPS



	Socket	Wattage	Energy consumption	Ø in cm	Length in cm	Colour temperature	Luminous flux	Colour rendering	Energy efficiency class	Life span	Item no.
Philips	GU6,5	20W	22kWh/1000h	1,3	5,7	3000K	1800lm	CRI 83	EEC=A	12000h	LI507020
		35W	41kWh/1000h			4200K	3900lm	CRI 90			LI507030
GE					5,2	4000K	3400lm			16000h	LI507031

Ceramic burner for high colour fidelity during the entire life span.

CDM-TC G8,5 HIT halogen metal halide



PHILIPS



	Socket	Wattage	Energy consumption	Ø in cm	Length in cm	Colour temperature	Luminous flux	Colour rendering	Energy efficiency class	Item no.
	G8,5	35W	41kWh/1000h	1,5	8,5	3000K	3000lm	CRI 81	EEC=A	LI507035
						4200K		CRI 85		LI507045
		70W	80kWh/1000h			3000K	6500lm	CRI 83		LI507037
						4200K	5900lm	CRI 89		LI507047

CDM-TC ELITE G8,5 HIT halogen metal halide



PHILIPS



	Socket	Wattage	Energy consumption	Ø in cm	Length in cm	Colour temperature	Luminous flux	Colour rendering	Energy efficiency class	Item no.
	G8,5	35W	42kWh/1000h	1,5	8,5	3000K	4000lm	CRI 90	EEC=A+	LI507400
		70W	80kWh/1000h				7650lm			LI507410

CDM-T ELITE G12 HIT halogen metal halide



PHILIPS



	Socket	Wattage	Energy consumption	Length in cm	Width in cm	Colour temperature	Luminous flux	Colour rendering	Energy efficiency class	Life span	Item no.
	G12	35W	42kWh/1000h	10,3	2,0	3000K	3700lm	CRI 90	EEC=A+	15000h	LI507420
		50W	55kWh/1000h				5400lm				LI507450
		70W	80kWh/1000h				7500lm				LI507430
		150W	163kWh/1000h	11,0	15000lm	CRI 92	12000h	LI507440			

CDM-T G12 HIT halogen metal halide



PHILIPS



	Socket	Wattage	Energy consumption	Length in cm	Width in cm	Colour temperature	Luminous flux	Colour rendering	Energy efficiency class	Item no.
	G12	35W	41kWh/1000h	10,3	2,0	3000K	3150lm	CRI 81	EEC=A	LI507120
						4200K	3300lm	CRI 84		LI507121
		70W	80kWh/1000h			3000K	6600lm	CRI 92		LI507130
						4200K				LI507131
		150W	165kWh/1000h			3000K	14000lm	CRI 88		LI507140
						4200K	12700lm	CRI 96		LI507141

Ceramic burner for high colour fidelity during the entire life span.



Rx7s HQI-TS HIT-DE halogen metal halide



OSRAM



Socket	Wattage	Energy consumption	Length in cm	Colour temperature	Luminous flux	Colour rendering	Energy efficiency class	Item no.
Rx7s	70W	86kWh/1000h	11,7	3300K	5925lm	CRI 70	EEC=A	LI509070
				4200K	6500lm	CRI 78		LI509071
	150W	165kWh/1000h	13,5	3200K	12000lm	CRI 70		LI509150
				4200K	12500lm	CRI 80		LI509151

Rx7s CDM-TD HIT-DE halogen metal halide



PHILIPS



Socket	Wattage	Energy consumption	Length in cm	Colour temperature	Luminous flux	Colour rendering	Energy efficiency class	Item no.
Rx7s	70W	78kWh/1000h	11,7	3000K	6000lm	CRI 82	EEC=A	LI507070
				4200K	5600lm	CRI 92		LI507071
	150W	161kWh/1000h	13,5	3000K	13250lm	CRI 88		LI507150
				4200K	14200lm	CRI 96		LI507151

Ceramic burner for high colour fidelity during the entire life span.

CMH MR16 PRECISE™ CONSTANTCOLOR™ GX10 HIPAR51



Socket	Wattage	Energy consumption	Ø in cm	Length in cm	Colour temperature	Luminosity	Luminous flux	Colour rendering	Beam angle	Energy efficiency class	Life span	Item no.	
GX10	20W	22kWh/1000h	5,1	5,45	3000K	2900cd	1000lm	CRI>80	25°	EEC=A	12000h	LI507220	
						1500cd			40°			LI507240	
GX10	35W	43kWh/1000h	5,1	5,45	3000K	5500cd	2200lm	CRI 90	25°	EEC=A	10000h	LI507320	
						3000cd			40°			LI507340	
					4200K	5500cd			CRI 92		25°	12000h	LI507321
						3000cd					40°		LI507341

Reflector alu-coated. To be operated with Electronic Ballast HID [470350] only.

Reflector alu-coated. To be operated with Electronic Ballast HID [LI470360] only.

BRITESPOT ES111 GX10 Halogen metal halide



SYLVANIA



Socket	Wattage	Energy consumption	Ø in cm	Colour temperature	Luminosity	Luminous flux	Colour rendering	Energy efficiency class	Item no.
GX10	35W	43kWh/1000h	11,1	3000K	10000cd	1800lm	CRI 90	EEC=A	LI506992
GX10	70W	83kWh/1000h	11,1	3000K	20000cd	3850lm	CRI 90	EEC=A	LI506982

Reflector alu-coated with shade. To be operated with Electronic Ballast HID [LI470360] only.

Reflector alu-coated with shade. To be operated with Electronic Ballast HID [LI470370] only.

HSI-MP E27 / -SX E40 HIE halogen metal halide



SYLVANIA



Socket	Wattage	Energy consumption	Ø in cm	Length in cm	Colour temperature	Luminous flux	Colour rendering	Energy efficiency class	Item no.
E27	70W	83kWh/1000h	5,4	14,2	2900K	5200lm	CRI 70	EEC=A	LI508170
					3800K	5500lm			LI508171
	150W	165kWh/1000h			2900K	12500lm			LI509170
					3800K	12500lm			LI509171
E40	250W	292kWh/1000h	9,0	22,7	4200K	20000lm	EEC=A+	LI509180	
	400W	468kWh/1000h	12,0	29,0		40000lm		LI509191	

Operation with ballast only.

HIT-T E40 HIT halogen metal halide



Socket	Wattage	Energy consumption	Ø in cm	Length in cm	Colour temperature	Luminous flux	Colour rendering	Energy efficiency class	Item no.
E40	400W	440kWh/1000h	4,7	27,5	4200K	42000lm	CRI 70	EEC=A+	LI510400

Operation with ballast only.



COLOR CONTROL COLO, Bulb, Master

220V~
-240V~

NEW



Socket	Wattage	Energy consumption	Ø in cm	Height in cm	LED colour	Luminous flux	Colour rendering	Energy efficiency class	Item no.
E27	8W	8kWh/1000h	6,4	12,2	RGB colour change + white (3000K)	white LED: 550lm	white LED: CRI>80	white LED: EEC=A	LI470676

Current draw: 70mA

Coming soon: January 2016

RGBW Master Bulb incl. remote control, can be extended with Slave Bulb [LI470673], transmitter coverage can be extended with WLAN Sync. Signal amplifier [LI470674], transmission frequency WLAN: 2,4-2,48GHz, coverage about 15 m, depending on the local conditions. 34 pre-set programmes,

30 pre-set static colours, 10 speed levels, 5 dimming stages RGB, 10 dimming stages for white,

2 „AAA“ 1,5 V batteries for remote control, not included. **Accessories/Included:** Remote control incl. [LI470677].

COLOR CONTROL COLO, Bulb, Slave

220V~
-240V~

NEW



Socket	Wattage	Energy consumption	Width in cm	Height in cm	LED colour	Luminous flux	Colour rendering	Energy efficiency class	Item no.
E27	8W	8kWh/1000h	6,4	12,2	RGB colour change + white (3000K)	white LED: 550lm	white LED: CRI>80	white LED: EEC=A	LI470673

Current draw: 70mA

Coming soon: January 2016

RGBW Slave Bulb for operation in connection with RGBW Master Bulb [LI470676], Master Controller [LI470671] or Touch Panel [LI470670] only, reception frequency WLAN 2,4-2,48GHz, max. distance to Master 15 m, depending on the local conditions.

FORTIMO LED TWISTABLE MODULE, Type SMD LED

230V~



PHILIPS



Socket	Wattage	Energy consumption	Ø in cm	Length in cm	Colour temperature	Luminous flux	Colour rendering	Energy efficiency class	Item no.
PHJ65-d	15W	15kWh/1000h	6,6	4,2	4000K	1100lm	CRI 80	EEC=A	▼ LI560201
	16W	16kWh/1000h			3000K				▼ LI560202

For application in: LI165204, LI230160/-4

Note: A compatibility list of the dimmers to be used is available on request.

LED G9, Typ SMD LED

230V~



Socket	Wattage	Energy consumption	Ø in cm	Length in cm	Colour temperature	Luminous flux	Colour rendering	Energy efficiency class	Item no.
G9	2,5W	3kWh/1000h	1,8	6	2700K	170lm	CRI 80	EEC=A+	▼ LI570022
	2W	2kWh/1000h	1,6	4,6	3000K	140lm			LI570023

LED R7s DESIGNBULB, 12W, dimmable

230V~



Socket	Wattage	Energy consumption	Length in cm	Width in cm	Height in cm	Colour temperature	Luminosity	Luminous flux	Colour rendering	Energy efficiency class	Item no.
R7s 118 mm	11W	11kWh/1000h	11,8	5,1	2,2	3000K	280cd	780lm	CRI 80	EEC=A+	LI551713

Current draw: 48mA

Dimmable with leading-edge dimmer. Please note the dimmer's utilised capacity.



LED MR16, 3,8W, Type SMD LED

12V- LED 3 pcs.



Socket	Wattage	Energy consumption	Ø in cm	Length in cm	Colour temperature	Luminosity	Luminous flux	Colour rendering	Energy efficiency class	Item no.
GU5,3	3,8W	5kWh/1000h	5,0	4,7	2700K	500cd	225lm	CRI 80	EEC=A+	LI551242
					3000K					LI551243
					4000K					LI551244

Current draw: 520mA. To be operated with a conventional transformer only.

LED MR16, 4,7W, Type COB LED

12V- LED 1 pcs. ta 40°



Socket	Wattage	Energy consumption	Ø in cm	Length in cm	Colour temperature	Luminosity	Luminous flux	Colour rendering	Beam angle	Energy efficiency class	Item no.
GU5,3	4,7W	5kWh/1000h	5,0	4,9	5000K	870cd	360lm	CRI 80	30°	EEC=A+	LI551301
					3000K						LI551302
					5000K	375cd					LI551311
					3000K						LI551312

Current draw: 660mA. To be operated with a conventional transformer only.

LED MR16, 7,3W, Type SMD LED

12V- LED 8 pcs.



Socket	Wattage	Energy consumption	Ø in cm	Length in cm	Colour temperature	Luminosity	Luminous flux	Colour rendering	Energy efficiency class	Item no.
GU5,3	7,3W	8kWh/1000h	5,0	5,0	3000K	1030cd	560lm	CRI 80	EEC=A+	LI551263

Current draw: 905mA. Suitable for open, ventilated fittings only. To be operated with a conventional transformer only.

MASTER LED MR16, 6,5W, Type SMD LED, dimmable

12V- LED 8 pcs.

PHILIPS



Socket	Wattage	Energy consumption	Ø in cm	Length in cm	Colour temperature	Luminosity	Luminous flux	Colour rendering	Energy efficiency class	Item no.
GU5,3	6,5W	7kWh/1000h	5,0	5,0	2700K	900cd	390lm	CRI 80	EEC=A	LI560172
					3000K	960cd	420lm		EEC=A+	LI560173

Current draw: 800mA. Suitable for open, ventilated fittings only. To be operated with an electronic or conventional transformer only.

MASTER LED MR16, 5W, Type SMD LED

12V- LED 10 pcs.

PHILIPS



Socket	Wattage	Energy consumption	Ø in cm	Length in cm	Colour temperature	Luminosity	Luminous flux	Colour rendering	Beam angle	Energy efficiency class	Item no.
GU5,3	5,5W	6kWh/1000h	4,7	4,9	2700K	1000cd	390lm	CRI 80	36°	EEC=A	LI560192

Current draw: 715mA. To be operated with a conventional transformer only.

LED MR16, 5W, Type COB LED

12V-

NEW



Socket	Wattage	Energy consumption	Ø in cm	Length in cm	Colour temperature	Luminous flux	Luminosity	Colour rendering	Energy efficiency class	Item no.
GU5,3	5W	6kWh/1000h	5,0	4,7	2700K	300lm	580cd	CRI 80	EEC=A+	LI551862

Current draw: 600mA. To be operated with a conventional transformer only.

Built-in temperature regulation: Overheating of the lamp is prevented by automatic reduction of the luminous flux.

LED GU10, 5W, Type SMD LED

220V-~240V-

NEW



Socket	Wattage	Energy consumption	Ø in cm	Length in cm	Colour temperature	Luminosity	Luminous flux	Colour rendering	Energy efficiency class	Item no.
GU10	5W	5kWh/1000h	5,0	5,6	2700K	670cd	360lm	CRI 80	EEC=A+	LI570052
					3000K	700cd	370lm			LI570053
					4000K	745cd	380lm			LI570054



LED GU10, 5,5W, Type SMD LED, dimmable

220V~
-240V~

40°



SYLVANIA

NEW



Socket	Wattage	Energy consumption	Ø in cm	Length in cm	Colour temperature	Luminosity	Luminous flux	Colour rendering	Energy efficiency class	Item no.
GU10	5,5W	6kWh/1000h	5,0	5,6	2700K	670cd	360lm	CRI 80	EEC=A+	LI570062
					3000K	700cd	370lm			LI570063
					4000K	745cd	380lm			LI570064

Current draw: 31mA

COREPRO LED SPOT GU10, Type PowerLED

230V~



36°



Suitable for closed fittings

PHILIPS



Socket	Wattage	Energy consumption	Ø in cm	Length in cm	Colour temperature	Luminosity	Luminous flux	Colour rendering	Energy efficiency class	Item no.
GU10	3,5W	4kWh/1000h	5,0	5,5	3000K	350cd	245lm	CRI 80	EEC=A+	LI560084

Current draw: 35mA

LED GU10, 4,3W, Type SMD LED

220V~
-240V~

40°



Socket	Wattage	Energy consumption	Ø in cm	Length in cm	Colour temperature	Luminosity	Luminous flux	Colour rendering	Energy efficiency class	Item no.
GU10	4,3W	5kWh/1000h	5,0	5,4	2700K	530cd	245lm	CRI 80	EEC=A+	LI551252
					3000K					LI551253
					4000K					LI551254

Current draw: 39mA

COREPRO LED GU10, 4,5W, Type SMD LED

220V~
-240V~

36°



PHILIPS



Socket	Wattage	Energy consumption	Ø in cm	Length in cm	Colour temperature	Luminosity	Luminous flux	Colour rendering	Energy efficiency class	Item no.
GU10	4,5W	5kWh/1000h	5	5,4	2700K	560cd	345lm	CRI 80	EEC=A+	LI560182

Current draw: 39mA

LED GU10, 5,6W, Type COB LED

230V~



ta 40°



Socket	Wattage	Energy consumption	Ø in cm	Length in cm	Colour temperature	Luminosity	Luminous flux	Colour rendering	Beam angle	Energy efficiency class	Item no.
GU10	5,6W	6kWh/1000h	5,0	5,7	5000K	920cd	380lm	CRI 80	30°	EEC=A+	LI551321
					3000K	895cd	370lm				LI551322
					5000K	395cd	380lm				LI551331
					3000K	385cd	370lm				LI551332

Current draw: 47mA

LED GU10, 6,5W, Type SMD LED

220V~
-240V~

36°



Socket	Wattage	Energy consumption	Ø in cm	Length in cm	Colour temperature	Luminosity	Luminous flux	Colour rendering	Energy efficiency class	Item no.
GU10	6,5W	7kWh/1000h	5,0	5,8	3000K	940cd	520lm	CRI 80	EEC=A+	LI551273

Current draw: 32mA. Suitable for open, ventilated fittings only.

LED GU10, 7W, Type COB LED

220V~
-240V~

38°



NEW



Socket	Wattage	Energy consumption	Ø in cm	Length in cm	Colour temperature	Luminosity	Luminous flux	Colour rendering	Energy efficiency class	Item no.
GU10	7W	7kWh/1000h	5,0	5,2	2700K	400lm	825cd	CRI 80	EEC=A	LI551872

Current draw: 49mA

Built-in temperature regulation: Overheating of the lamp is prevented by automatic reduction of the luminous flux.



MASTER LED GU10, 4,5W, Type SMD LED, dimmable

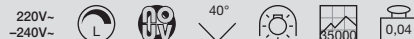

PHILIPS



Socket	Wattage	Energy consumption	Ø in cm	Length in cm	Colour temperature	Luminosity	Luminous flux	Colour rendering	Energy efficiency class	Item no.
GU10	3,5W	4kWh/1000h	5	5,5	2700K	600cd	355lm	CRI 80	EEC=A++	LI560122
					3000K		270lm			LI560123
					4000K		290lm			LI560124

Current draw: 20mA

MASTER LED GU10, 5,3W, Type SMD LED, dimmable

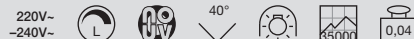

PHILIPS



Socket	Wattage	Energy consumption	Ø in cm	Length in cm	Colour temperature	Luminosity	Luminous flux	Colour rendering	Energy efficiency class	Item no.
GU10	4,5W	5kWh/1000h	5	5,5	2700K	800cd	355lm	CRI 80	EEC=A++	LI560142
					3000K		365lm			LI560143
					4000K		390lm			LI560144

Current draw: 23mA

LED GU10, 7W, Type SMD LED, dimmable



Socket	Wattage	Energy consumption	Ø in cm	Length in cm	Colour temperature	Luminosity	Luminous flux	Colour rendering	Energy efficiency class	Item no.
GU10	7W	7kWh/1000h	5,0	5,8	3000K	940cd	520lm	CRI 80	EEC=A+	LI51283

Dimmable with leading-edge and LED dimmer. Please note the dimmer's utilised capacity.
Current draw: 47mA. Suitable for open, ventilated fittings only.

PHILIPS LED AR111, Type PowerLED



PHILIPS



Socket	Wattage	Energy consumption	Ø in cm	Length in cm	Colour temperature	Luminosity	Luminous flux	Colour rendering	Beam angle	Energy efficiency class	Item no.
G53	10W	11kWh/1000h	11,1	5,6	2700K	3360cd	600lm	CRI 80	24°	EEC=A	LI560031
									40°		LI560032
					3000K	3470cd	620lm		24°		LI560033
									40°		LI560034

Current draw: 1100mA. Operation with electronic or conventional transformer. Please note the transformer's utilised capacity.

MEGAMAN LED AR111, 11W, Type COB LED



Socket	Wattage	Energy consumption	Ø in cm	Length in cm	Colour temperature	Luminosity	Luminous flux	Colour rendering	Beam angle	Energy efficiency class	Item no.
G53	11W	12kWh/1000h	11,1	5,8	2800K	3400cd	450lm	CRI 80	24°	EEC=A	LI570041
									45°		LI570042
					4000K	3400cd	450lm		24°		LI570043
									45°		LI570044

Current draw: 1000mA. Operation with electronic or conventional transformer. Please note the transformer's utilised capacity.

LED AR111, 15W, Type PowerLED



Socket	Wattage	Energy consumption	Ø in cm	Length in cm	Colour temperature	Luminosity	Luminous flux	Colour rendering	Beam angle	Energy efficiency class	Item no.
G53	15W	16kWh/1000h	11,0	6,0	2700K	1230cd	810lm	CRI 80	30°	EEC=A	LI551602
											4000K
					2700K	300cd	680lm		140°		LI551612
											4000K

Current draw: 1750mA. Operation with conventional transformer only.

MASTER LED AR111, 15W, Type PowerLED, dimmable



PHILIPS



Socket	Wattage	Energy consumption	Ø in cm	Length in cm	Colour temperature	Luminosity	Luminous flux	Colour rendering	Beam angle	Energy efficiency class	Item no.
G53	15W	16kWh/1000h	11,1	5,6	2700K	4750cd	800lm	CRI 80	24°	EEC=A	LI560131
									40°		LI560132
					3000K	4950cd	840lm		24°		LI560133
									40°		LI560134

Current draw: 1600mA. Operation with electronic or conventional transformer. Please note the transformer's utilised capacity.



LED QRB111, 19,5W, Type PowerLED, dimmable

12V~

LED
7 pcs.

Socket	Wattage	Energy consumption	Ø in cm	Length in cm	Colour temperature	Luminosity	Luminous flux	Colour rendering	Beam angle	Energy efficiency class	Housing colour	Item no.
G53	19,5W	21kWh/1000h	11,1	6,1	4000K	1730cd	1140lm	CRI 80	30°	EEC=A	silver-grey	LI551400
											black	LI570602
											green	LI570612
											red	LI570622
					2700K	420cd	950lm		140°		silver-grey	LI551410
											black	LI570632
											green	LI570642
											red	LI570652

Current draw: 1850mA. Operation with electronic or conventional transformer. Please note the transformer's utilised capacity.

LED AR111, 19W, Type PowerLED, dimmable

12V~

LED
7 pcs.

ta 40°



Socket	Wattage	Energy consumption	Ø in cm	Length in cm	Colour temperature	Luminosity	Luminous flux	Colour rendering	Beam angle	Energy efficiency class	Item no.
G53	19W	21kWh/1000h	11,0	6,0	4000K	1500cd	990lm	CRI 90	30°	EEC=A	LI551624
						1250cd	830lm		140°		LI551634

Current draw: 1830mA. Operation with electronic or conventional transformer. Please note the transformer's utilised capacity.

LED ES111, 9,6W, Type PowerLED

230V~

LED
6 pcs.

Socket	Wattage	Energy consumption	Ø in cm	Length in cm	Colour temperature	Luminosity	Luminous flux	Colour rendering	Beam angle	Energy efficiency class	Item no.
GU10	9,6W	10kWh/1000h	11,0	6,9	3000K	4250cd	650lm	CRI 82	20°	EEC=A+	LI550342
						1180cd			36°		LI550352

Current draw: 50mA

DOMELED ES111, 9W, Type PowerLED

230V~

LED
6 pcs.

Socket	Wattage	Energy consumption	Ø in cm	Length in cm	Colour temperature	Luminosity	Luminous flux	Colour rendering	Beam angle	Energy efficiency class	Item no.
GU10	9W	9kWh/1000h	11,0	7,8	3000K	420lm	230lm	CRI 80	25°	EEC=A	LI550382
						60°			LI550392		

Current draw: 45mA

LED ES111, 6,5W, Type PowerLED

220V~
-240V~

NEW



Socket	Wattage	Energy consumption	Ø in cm	Length in cm	Colour temperature	Luminosity	Luminous flux	Colour rendering	Energy efficiency class	Item no.
GU10	6,5W	7kWh/1000h	11,0	7,0	2700K	390lm	785cd	CRI 80	EEC=A+	LI551882

Current draw: 46mA.

Built-in temperature regulation: Overheating of the lamp is prevented by automatic reduction of the luminous flux.



832 | LED LAMPS

LED ES111, 17,5W, Type PowerLED, dimmable

230V~ LED 7 pcs. 0,19



Socket	Wattage	Energy consumption	Ø in cm	Length in cm	Colour temperature	Luminous flux	Luminosity	Colour rendering	Beam angle	Energy efficiency class	Housing colour	Item no.				
GU10	17,5W	18kWh/1000h	11,1	7,1	2700K	880lm	1340cd	CRI 80	30°	EEC=A	black	LI570502				
											green	LI570512				
											red	LI570522				
											silver-grey	LI551642				
											silver-grey	LI551644				
											silver-grey	LI551652				
					2700K	750lm	-	black	LI570532							
								green	LI570542							
								red	LI570552							
								red	LI551654							
								silver-grey	LI551664							
								silver-grey	LI551674							
4000K	950lm	-	-	-	-	-	-	-	-	-	-	-				
													870lm	1320cd	CRI 90	30°
													740lm	-		140°

Current draw: 78mA. Please note the dimmer's minimal utilised capacity.

LED ES111, 15,5W, Type PowerLED

230V~ 0,19



Socket	Wattage	Energy consumption	Ø in cm	Length in cm	Colour temperature	Luminous flux	Luminosity	Colour rendering	Beam angle	Energy efficiency class	Housing colour	Item no.							
GU10	15,5W	16kWh/1000h	11,1	7,1	2700K	680lm	1035cd	CRI 80	30°	EEC=A	black	LI570662							
											silver-grey	LI570672							
											green	LI570682							
											red	LI570692							
											black	LI570702							
											silver-grey	LI570712							
						590lm	-	-	-		-	-	-	-	-	-	-	black	LI570722
																		silver-grey	LI570732
																		green	LI570772
																		red	LI570782
																		red	LI570792
																		red	LI570732

Current draw: 119mA.

VINTA E14, 2W/4W, Type SMD LED

220V~ -240V~ 0,02



Socket	Wattage	Energy consumption	Ø in cm	Length in cm	Colour temperature	Luminous flux	Colour rendering	Energy efficiency class	Item no.
E14	2W	2kWh/1000h	3,6	10,0	2700K	200lm	CRI 80	EEC=A++	LI551812

Current draw: 16mA.

E14	4W	4kWh/1000h	3,6	10,0	2700K	370lm	CRI 80	EEC=A+	LI551822
-----	----	------------	-----	------	-------	-------	--------	--------	----------

Current draw: 30mA.

COREPRO LED CANDLE E14, 3W, Type SMD LED

220V~ -240V~ LED 7 pcs. 0,03

PHILIPS



Socket	Wattage	Energy consumption	Ø in cm	Length in cm	Colour temperature	Luminous flux	Colour rendering	Energy efficiency class	Item no.
E14	3W	3kWh/1000h	3,7	11,3	2700K	250lm	CRI 80	EEC=A+	LI560222

Current draw: 30mA

VINTA E27, 2,5W/4W, Typ SMD LED

220V~ -240V~ 0,04



Socket	Wattage	Energy consumption	Ø in cm	Length in cm	Colour temperature	Luminous flux	Colour rendering	Energy efficiency class	Item no.
E27	2,5W	3kWh/1000h	5,8	13,2	2200K	200lm	CRI 80	EEC=A+	LI551751

Current draw: 20mA.

E27	4W	4kWh/1000h	5,8	13,2	2200K	350lm	CRI 80	EEC=A+	LI551761
-----	----	------------	-----	------	-------	-------	--------	--------	----------

Current draw: 30mA.



VINTA E27, 5W, Type SMD LED

220V-
-240V-

NEW



Socket	Wattage	Energy consumption	Ø in cm	Length in cm	Colour temperature	Luminous flux	Colour rendering	Energy efficiency class	Item no.
E27	5W	5kWh/1000h	6,0	10,4	3000K	500lm	CRI 80	EEC=A+	LI51792

Current draw: 40mA.

VINTA E27, TOP MIRROR REFLECTOR LAMP, 5W, Type SMD LED

220V-
-240V-

NEW



Socket	Wattage	Energy consumption	Ø in cm	Length in cm	Colour temperature	Luminous flux	Colour rendering	Energy efficiency class	Item no.
E27	5W	5kWh/1000h	6,0	10,4	2700K	520lm	CRI 80	EEC=A++	LI551842

Current draw: 40mA.

E27 LED SMALL BALL, 4W / 6W, Type SMD LED

230V-



Socket	Wattage	Energy consumption	Ø in cm	Length in cm	Weight in kg	Colour temperature	Luminous flux	Colour rendering	Energy efficiency class	Item no.
E27	4W	4kWh/1000h	5,0	8,3	0,07	3000K	260lm	CRI 80	EEC=A+	LI551543

Current draw: 44mA.

E27	6W	6kWh/1000h	6,0	9,6	0,08	3000K	450lm	CRI 80	EEC=A+	LI551553
-----	----	------------	-----	-----	------	-------	-------	--------	--------	----------

Current draw: 50mA.

E27 TUBE LED, 4,7W, Type SMD LED

230V- ta 40°



Socket	Wattage	Energy consumption	Ø in cm	Length in cm	Colour temperature	Luminous flux	Colour rendering	Energy efficiency class	Item no.
E27	4,7W	5kWh/1000h	4,5	13,9	3000K	380lm	CRI 81	EEC=A+	LI551532

Current draw: 40mA. Specially for application in outdoor fittings with limited space for lamps, such as the Rusty range.

COREPRO LED E27, 5,5W, Type SMD LED

220V-
-240V-

PHILIPS



Socket	Wattage	Energy consumption	Ø in cm	Length in cm	Colour temperature	Luminous flux	Colour rendering	Energy efficiency class	Item no.
E27	5,5W	6kWh/1000h	5,6	10,3	2700K	470lm	CRI 80	EEC=A+	LI560160

Current draw: 50mA.

COREPRO LED E27, 9,5W, Type SMD LED, dimmable

220V-
-240V-

PHILIPS



Socket	Wattage	Energy consumption	Ø in cm	Length in cm	Colour temperature	Luminous flux	Colour rendering	Energy efficiency class	Item no.
E27	9,5W	10kWh/1000h	6,0	11,0	2700K	806lm	CRI 80	EEC=A+	LI560161

Current draw: 60mA.

MASTER LED E27, 13W / 18W, Type SMD LED, dimmable

220V-
-240V-

PHILIPS



Socket	Wattage	Energy consumption	Ø in cm	Length in cm	Colour temperature	Luminous flux	Colour rendering	Energy efficiency class	Item no.
E27	13W	13kWh/1000h	6,1	12,7	2700K	1055lm	CRI 80	EEC=A+	LI560150

Current draw: 62mA.

E27	18W	18kWh/1000h	6,6	12,3	2700K	1521lm	CRI 80	EEC=A+	LI560151
-----	-----	-------------	-----	------	-------	--------	--------	--------	----------

Current draw: 90mA.



MASTER LED PAR30 E27, 9,5W, Type PowerLED, dimmable

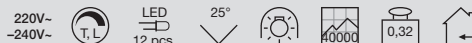

PHILIPS



Socket	Wattage	Energy consumption	Ø in cm	Length in cm	Colour temperature	Luminosity	Luminous flux	Colour rendering	Energy efficiency class	Item no.
E27	9,5W	10kWh/1000h	9,2	9,4	2700K	3500cd	650lm	CRI 80	EEC=A+	LI560212

Current draw: 46mA. Suitable for open, ventilated fittings only.

LED GX53, 4,2W, Type PowerLED



Socket	Wattage	Energy consumption	Ø in cm	Length in cm	Colour temperature	Luminosity	Luminous flux	Colour rendering	Energy efficiency class	Item no.
GX53	4,2W	5kWh/1000h	7,5	3,5	3000K	550cd	200lm	CRI 80	EEC=A	LI550092

Current draw: 41mA

LED GX53, 3W, Type SMD LED



Socket	Wattage	Energy consumption	Ø in cm	Length in cm	Colour temperature	Luminosity	Colour rendering	Energy efficiency class	Item no.
					6500K	260lm			
3000K	250lm	CRI 83	LI551372						

Current draw: 30mA

LED GX53, 7,5W, Type SMD LED



Socket	Wattage	Energy consumption	Ø in cm	Length in cm	Colour temperature	Luminosity	Luminous flux	Colour rendering	Energy efficiency class	Item no.
GX53	7,5W	8kWh/1000h	7,6	3,5	3000K	1235cd	450lm	CRI 82	EEC=A	LI550082

Current draw: 37mA

LED GX53, 8,2W, Type SMD LED

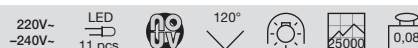

Socket	Wattage	Energy consumption	Ø in cm	Length in cm	Colour temperature	Luminosity	Colour rendering	Energy efficiency class	Item no.
					3000K	600lm			
4000K	620lm	LI550074							

Current draw: 62mA

T8-LED



Socket	Wattage	Energy consumption	Ø in cm	Length in cm	Weight in kg	Colour temperature	Luminous flux	Colour rendering	Energy efficiency class	Item no.
G13	18W	18kWh/1000h	2,8	120	0,34	4000K	1600lm	CRI 80	EEC=A+	LI570074
						6500K	1800lm			LI570076
	26W	26kWh/1000h		4000K	2400lm	LI570084				
				6500K	2700lm	LI570086				

Operation **without** ballast. Lamp surface frosted.

Current draw 18W: 82mA

Current draw 26W: 119mA



MINILYNX E14 Energy-saving lamp

230V~



SYLVANIA



Socket	Wattage	Energy consumption	Ø in cm	Length in cm	Colour temperature	Luminous flux	Colour rendering	Energy efficiency class	Item no.
E14	11W	11kWh/1000h	4,8	10,0	2700K	600lm	CRI 82	EEC=A	LI508630
				10,2	4000K		CRI 80		LI508631

Current draw: 80mA

MINILYNX E27 Energy-saving lamp

230V~



SYLVANIA



Socket	Wattage	Energy consumption	Ø in cm	Length in cm	Weight in kg	Colour temperature	Luminous flux	Colour rendering	Energy efficiency class	Item no.
E27	11W	11kWh/1000h	4,8	9,6	0,06	2700K	600lm	CRI 80	EEC=A	LI508730
						4000K		CRI 80		LI508731

Current draw: 85mA

E27	15W	15kWh/1000h	4,8	11,2	0,07	2700K	900lm	CRI 80	EEC=A	LI508740
						4000K		CRI 80		LI508741

Current draw: 110mA

E27	20W	20kWh/1000h	4,8	13,8	0,08	2700K	1200lm	CRI 80	EEC=A	LI508760
						4000K		CRI 80		LI508761

Current draw: 150mA

E27	23W	23kWh/1000h	4,8	15,0	0,08	2700K	1450lm	CRI 80	EEC=A	LI508770
						4000K		CRI 80		LI508771

Current draw: 185mA

ELD E27 Energy-saving lamp

230V~



PHILIPS



Socket	Wattage	Energy consumption	Ø in cm	Length in cm	Colour temperature	Luminous flux	Colour rendering	Energy efficiency class	Item no.
E27	11W	11kWh/1000h	4,4	11,7	2700K	600lm	CRI 80	EEC=A	LI508211

Current draw: 80mA

ELD E27 TC-TSE 2-turn, 15W, energy-saving lamp

230V~



Socket	Wattage	Energy consumption	Ø in cm	Length in cm	Colour temperature	Luminous flux	Colour rendering	Energy efficiency class	Item no.
E27	15W	15kWh/1000h	4,6	14,8	2700K	800lm	CRI 80	EEC=A	LI508415

Current draw: 108mA

MASTER STAIRWAY ELT E27 ELT 3-turn energy-saving lamp

230V~



PHILIPS



Socket	Wattage	Energy consumption	Ø in cm	Length in cm	Weight in kg	Colour temperature	Luminous flux	Colour rendering	Energy efficiency class	Item no.
E27	15W	15kWh/1000h	4,8	12,6	0,08	2700K	850lm	CRI 82	EEC=A	LI508600
	20W	20kWh/1000h		13,7	0,09		1230lm			LI508610

Suitable for application with motion sensors. Ignition time: 1 sec., start-on time: 20 sec., mercury content: < 1,41 mg.

ELT E27 ELT 3-turn energy-saving lamp

230V~



Socket	Wattage	Energy consumption	Ø in cm	Length in cm	Weight in kg	Colour temperature	Luminous flux	Colour rendering	Energy efficiency class	Item no.
E27	20W	20kWh/1000h	4,5	14,6	0,07	2700K	1185lm	CRI 82	EEC=A	LI508416
	23W	23kWh/1000h	5,1	15,1	0,09		1400lm			LI508417

Current draw: 180mA



E27 Energy-saving lamp



PHILIPS



Socket	Wattage	Energy consumption	Ø in cm	Length in cm	Weight in kg	Colour temperature	Luminous flux	Colour rendering	Energy efficiency class	Item no.
E27	12W	12kWh/1000h	4,75	9,4	0,05	2700K	741lm	CRI 82	EEC=A	LI509002
	15W	15kWh/1000h	5,15	10,75			970lm			LI509012
	23W	23kWh/1000h	6,15	11,85	0,08	1570lm	LI509022			

Current draw: 90 / 110 / 170 mA

PAR38 E27 Energy-saving lamp



PHILIPS



Socket	Wattage	Energy consumption	Ø in cm	Length in cm	Colour temperature	Luminosity	Luminous flux	Colour rendering	Energy efficiency class	Item no.
E27	18W	18kWh/1000h	12,2	14,0	2700K	280cd	945lm	CRI 81	EEC=A	LI519622

Current draw: 140mA

TC-S G23 TC-S 2-pin energy-saving lamp



PHILIPS

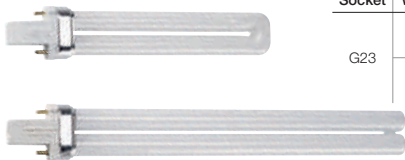

Socket	Wattage	Energy consumption	Ø in cm	Length in cm	Weight in kg	Colour temperature	Luminous flux	Colour rendering	Energy efficiency class	Item no.
G23	9W	11kWh/1000h	2,8	16,7	0,03	2700K	600lm	CRI 82	EEC=A	LI508209
				23,5		4000K				LI508309
	11W	15kWh/1000h	0,04	2700K	900lm	LI508310				
						4000K	LI508311			

TC-D G24D-1 / TC-D G24D-2 / TC-D G24D-3 TC-D 2-pin energy-saving lamp



PHILIPS



Socket	Wattage	Energy consumption	Ø in cm	Length in cm	Weight in kg	Colour temperature	Luminous flux	Colour rendering	Energy efficiency class	Life span	Item no.	
G24d-1	13W	17kWh/1000h	4,1	13,8	0,05	3000K	900lm	CRI 82	EEC=A	10000h	LI508213	
				15,1		4000K					LI508313	
G24d-2	18W	22kWh/1000h	15,1	0,06	2700K	1200lm	CRI 82			EEC=B	12000h	LI508218
					4000K							LI508318
G24d-3	26W	32kWh/1000h	17,1	0,06	2700K	1800lm		CRI 83	10000h		LI508226	
					4000K						LI508326	

TC-DE G24Q-1 / TC-DE G24Q-2 / TC-DE G24Q-3 TC-DE 4-pin energy-saving lamp



PHILIPS



Socket	Wattage	Energy consumption	Ø in cm	Length in cm	Weight in kg	Colour temperature	Luminous flux	Colour rendering	Energy efficiency class	Item no.
G24q-1	13W	15kWh/1000h	4,1	13,1	0,05	3000K	900lm	CRI 83	EEC=A	LI508212
						4000K		CRI 82		LI508312
G24q-2	18W	20kWh/1000h	14,3	0,06	3000K	1200lm	CRI 83	LI508220		
							4000K	CRI 82		LI508320
G24q-3	26W	29kWh/1000h	16,4	0,06	3000K	1760lm	CRI 83	LI508222		
							4000K	CRI 82		LI508322

TC-L 2G11 TC-L 2G11 4-pin energy-saving lamp



Socket	Wattage	Energy consumption	Length in cm	Width in cm	Height in cm	Weight in kg	Colour temperature	Luminous flux	Colour rendering	Energy efficiency class	Item no.
2G11	18W	20kWh/1000h	22,7	3,9	2,4	0,07	2700K	1200lm	CRI 82	EEC=A	LI508460
							4000K				LI508461
	24W	26kWh/1000h	32,2	0,08	2700K	1800lm	LI508440				
					4000K		LI508441				
	36W	40kWh/1000h	41,7	0,10	2700K	2900lm	LI590144				
					4000K		LI590145				
	55W	61kWh/1000h	54,2	0,13	3000K	4800lm	LI508450				
					4000K		LI508451				

MICROLYNX Energy-saving lamp



SYLVANIA



Socket	Wattage	Energy consumption	Ø in cm	Length in cm	Colour temperature	Luminous flux	Colour rendering	Energy efficiency class	Item no.
GX53	6W	6kWh/1000h	7,5	2,1	3000K	235lm	CRI 80	EEC=A	LI508421
					4000K				LI508422

Current draw: 45mA. Direct current operation possible.



GX53 Energy-saving lamp

230V~ 120°



Socket	Wattage	Energy consumption	Ø in cm	Length in cm	Colour temperature	Luminosity	Luminous flux	Colour rendering	Energy efficiency class	Item no.
GX53	9W	9kWh/1000h	7,5	2,7	2700K	100cd	260lm	CRI 80	EEC=A	LI508860
					4000K					LI508861

Current draw: 60mA. Direct current operation **not** possible.

RING TUBE T5 / T8 Energy-saving lamp

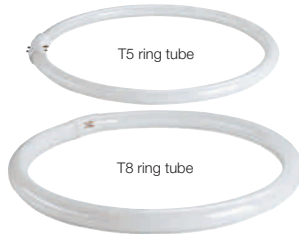

Socket	Wattage	Energy consumption	Ø in cm	Weight in kg	Colour temperature	Luminous flux	Colour rendering	Energy efficiency class	Life span	Item no.
2GX13	22W	25kWh/1000h	22,5	0,09	3000K	1800lm	CRI 82	EEC=A	10000h	LI548220
					4000K					LI548221
	40W	44kWh/1000h	30,0	0,12	3000K	3300lm				LI548240
					4000K					LI548241
G10q	32W	39kWh/1000h	30,0	0,21	3000K	2375lm	CRI 85	EEC=A	9000h	LI548230
					4000K					LI548231
	40W	48kWh/1000h	40,6	0,25	3000K	3200lm				LI548210
					4000K					LI548211

T5 / T5 COLOUR / T8 Energy-saving lamp



Socket	Wattage	Energy consumption	Ø in cm	Length in cm	Weight in kg	Colour temperature	Luminous flux	Colour rendering	Energy efficiency class	Life span	Item no.	
G5	8W	9kWh/1000h	1,6	28,8	0,03	3000K	400lm	CRI 53	EEC=A	10000h	LI591293	
				53,0	0,05	4000K		CRI 64			LI591294	
	13W	15kWh/1000h		53,0	0,05	3000K	950lm	CRI>80		EEC=A	12000h	LI591295
				54,9	0,04	4000K						LI591296
	14W	16kWh/1000h		54,9	0,04	3000K	1200lm	CRI 85		EEC=A+	24000h	LI548014
				85,0	0,08	4000K						LI548114
21W	-	-	85,0	0,08	blau	500lm	-	-	LI548167			

Packaging unit: 25 pcs. [Packagings of 3 available **without** extra charge. Please contact our sales team.]

G5	21W	23kWh/1000h	1,6	85,0	0,07	3000K	1900lm	CRI 85	EEC=A+	24000h	LI548021	
				56,3	0,04	4000K					LI548121	
	24W	26kWh/1000h		56,3	0,04	2700K	1750lm	CRI 85	EEC=A		24000h	LI548023
				55,0	0,04	3000K						LI548024
	28W	31kWh/1000h		115,0	0,08	4000K	2600lm	CRI 85	EEC=A+		24000h	LI548124
				115,0	0,08	3000K						LI548028
	35W	38kWh/1000h		145,0	0,10	4000K	3300lm	CRI 85	EEC=A+		24000h	LI548035
				145,0	0,10	3000K						LI548135
	39W	44kWh/1000h		85,0	0,07	4000K	3200lm	CRI 85	EEC=A+		24000h	LI548039
				115,0	0,08	3000K						LI548139
54W	60kWh/1000h	-	115,0	0,08	4000K	4450lm	-	-	LI548054			

Packaging unit: 10 pcs. [Packagings of 3 available **without** extra charge. Please contact our sales team.]

G13	18W	22kWh/1000h	2,6	59,0	0,08	4000K	1350lm	CRI 85	EEC=A	20000h	LI548201
						3000K					LI548202

Packaging unit: 25 pcs. [Packagings of 3 available **without** extra charge. Please contact our sales team.]

Please note:

In addition to the indicated packaging units, we also offer packagings of 3 **with no extra charge**. For technical reasons related to despatch, single lamps cannot be shipped.

- 1-circuit HV Set.....421
 1-circuit HV track, recessed409
 1-circuit HV track, surface-mounted.....410
 1-circuit pendant adapter.....057, 411, 424
 1 QRB MODULE
 for AIXLIGHT® PENDANT SYSTEM.....107
 2 QRB MODULE
 for AIXLIGHT® PENDANT SYSTEM.....107
 35W HIT MODULE
 for AIXLIGHT® PENDANT SYSTEM.....107
 4-turn garden socket.....818
 70W HIT MODULE
 for AIXLIGHT® PENDANT SYSTEM.....107
 90° connector for PROFILE 1808.....768
 90° solder corners for FLEXLED ROLL
 and FLEXLED ROLL PRO 12V/24V.....778
- A**
- ACCANTO LEDSPOT ROUND wall light ...177
 ACCANTO LEDspot wall light.....177
 Acrylic cover
 for LinearPROFILE 1107770
 ACRYLBOX DOUBLE ES111
 ceiling light315
 ACRYLBOX DOUBLE GU10
 ceiling light315
 ACRYLBOX DOUBLE QRB111
 ceiling light315
 ACRYLBOX SINGLE ES111 ceiling light ...315
 ACRYLBOX SINGLE GU10 ceiling light ...315
 ACRYLBOX SINGLE QRB111
 ceiling light315
 Acrylic cover
 for PROFILE 1808, 2508, 2720.....768, 773
 Acrylic cover, BRICK COVER
 for PROFILE 2609.....760
 Acrylic cover, DOME COVER
 for PROFILE 2609.....760
 Acrylic cover, FLAT COVER
 for PROFILE 2609.....760
 Adapter for 1-circuit HV track.....411
 ADEGAN floor stand545
 ADEGAN MANILA SL floor stand543
 ADEGAN MANILA TL table lamp.....543
 ADJUST GU10 recessed spot.....732
 ADJUST HQI 70 inground fitting739
 ADJUST QRB111 inground fitting735
 ADJUST QUADRO GU10
 recessed spot732
 AERO GU10 Spot, for 3-circuit401
 AERO GU10, for 1-circuit.....419
 AIR INDI 22 wall and ceiling light159
 AIR INDI 33 wall and ceiling light288
 AIR INDI display light.....193
 AITES LED ROUND.....535
 AIXLIGHT® DUO ES111 pendant125
 AIXLIGHT® FLAT DOUBLE ES111
 ceiling recessed light475
 AIXLIGHT® FLAT DOUBLE QRB111
 ceiling recessed light475
 AIXLIGHT® FLAT SINGLE ES111
 ceiling recessed light475
 AIXLIGHT® FLAT SINGLE QRB111
 ceiling recessed light475
 AIXLIGHT® KARDATRACK QRB111/4.....395
 AIXLIGHT® LONG ES111 pendant125
 AIXLIGHT® LONG GU10 pendant.....122
 AIXLIGHT® LONG QRB111 pendant123
 AIXLIGHT® PENDANT SYSTEM
 BASIC FRAME 1106
 BASIC FRAME 2106
 AIXLIGHT® PRO 1 FLAT FRAME ROUND
 installation frame479
 AIXLIGHT® PRO 1 FRAME installation frame
 478
 AIXLIGHT® PRO 1 FRAME ROUND
 installation frame478
 AIXLIGHT® PRO 1 FRAMELESS
 installation frame478
 AIXLIGHT® PRO 1 FRAMELESS ROUND
 installation frame478
 AIXLIGHT® PRO 2 FLAT FRAME ROUND
 installation frame479
 AIXLIGHT® PRO 2 FRAME
 installation frame478
 AIXLIGHT® PRO 2 FRAME ROUND
 installation frame478
 AIXLIGHT® PRO 2 FRAMELESS
 installation frame478
 AIXLIGHT® PRO 3 FRAME
 installation frame478
 AIXLIGHT® PRO 3 FRAMELESS
 installation frame478
 AIXLIGHT® PRO 50 1 FRAME
 installation frame483
 AIXLIGHT® PRO 50 1 FRAMELESS
 installation frame.....483
 AIXLIGHT® PRO 50 2 FRAME
 installation frame483
 AIXLIGHT® PRO 50 2 FRAMELESS
 installation frame483
 AIXLIGHT® PRO FLAT FRAMELESS 1
 ROUND installation frame.....479
 AIXLIGHT® PRO FLAT FRAMELESS 2
 ROUND installation frame.....479
 AIXLIGHT® R DUO HQI111 pendant100
 AIXLIGHT® R DUO QRB111 pendant.....100
 AIXLIGHT® R LONG QRB111 pendant.....101
 AIXLIGHT® R Office T5 39W pendant.....102
 AIXLIGHT® R OFFICE T5 54W, pendant...102
 AIXLIGHT® R WALL QRB111 wall light.....219
 AIXLIGHT® R2 DUO HQI111 pendant100
 AIXLIGHT® R2 DUO QRB111 pendant.....100
 AIXLIGHT® R2 LONG QRB111 pendant...101
 AIXLIGHT® R2 Office T5 39W pendant...103
 AIXLIGHT® R2 OFFICE T5 54W,
 pendant103
 AIXLIGHT® R2 SQUARE QRB111
 pendant101
 AIXLIGHT® R2 WALL QRB111 wall light...219
 AIXLIGHT® SQUARE ES111 pendant.....125
 AIXLIGHT® SQUARE GU10 pendant122
 AIXLIGHT® SQUARE QRB111 pendant...123
 ALDA wall recessed light.....709
 ALPA CONE 100 floor stand599
 ALPA CONE 75 floor stand599
 ALPA MUSHROOM 40 floor stand599
 ALPA MUSHROOM 75 floor stand599
 ALTRA DICE 2 ceiling light.....206, 345
 ALTRA DICE 3 ceiling light.....206, 345
 ALTRA DICE ceiling light.....305
 ALTRA DICE SPOT 1 ceiling light.....345
 ALTRA DICE SPOT 2 ceiling light.....345
 ALTRA DICE SPOT for 1-circuit423
 ALTRA DICE SPOT for 3-circuit401
 ALTRA DICE wall light231
 ALTRA DICE WDL-2 wall light239
 Aluminium deco cover
 for AIXLIGHT® PRO.....481
 Aluminium earth spike
 for ADEGAN and PLENUM floor stand...545
 Aluminium reflector
 for SLEEK SPOT G12389
 ANGOLUX WALL wall light674
 ANILA spot for EASYTEC® II.....433
 ANILA spot for EASYTEC® II.....433
 ANILA spot for WAVE.....445
 ANILA spot MR16 for LINUX LIGHT®441
 ANILA spot MR16 for LINUX LIGHT®441
 AQUADOWN MICRO729
 ARLINA T5 24 wall light.....268
 ARLINA T5 28 wall light.....268
 ARROCK ARC GU10, floor stand.....575
 ARROCK GRANITE 40 floor stand577
 ARROCK GRANITE 40 ROUND
 floor stand.....577
 ARROCK GRANITE 70 floor stand577
 ARROCK GRANITE 70 ROUND
 floor stand.....577
 ARROCK SAND 40 floor stand.....573
 ARROCK SAND 70 floor stand.....573
 ARROCK SLOT GU10 floor stand575
 ARROCK STONE LED.....573
 ARTE 300 toroidal transformer813
 ASSO LED 300 wall light.....225
 ASSO LED wall light.....225
 ASTINA OUT ESL.....641
 ASTINA STEEL GU 10, wall light641
 ASTINA STEEL LED, wall light641
 ASTINA UP/DOWN wall light.....253
 ASTO I wall and ceiling light.....205, 339
 ASTO II wall and ceiling light.....205, 339
 ASTO III wall and ceiling light205, 339
- ASTO IV wall and ceiling light205, 339
 ASTO TUBE 3 ROUND,
 wall and ceiling light347
 ASTO TUBE I
 wall and ceiling light201, 347
 ASTO TUBE II
 wall and ceiling light201, 347
 ASTO TUBE III
 wall and ceiling light201, 347
 ASTO TUBE wall light.....181
- B**
- BACCO 70 floor stand561
 BACCO 90 floor stand561
 BARRO 1 wall and ceiling light206, 340
 BARRO 2 wall and ceiling light206, 341
 BARRO ceiling light, CL-1307
 BARRO WL-1, UP/DOWN wall light.....253
 Base for NEW MYRA 1 & 2 lamp heads...603
 Baseboard751
 BASKET wall light163
 BEDSIDE wall light536
 Bending machine for EASYTEC® II431
 Bending machine for LINUX LIGHT®.....439
 BERRET G12 downlight511
 BERRA 30 floor stand597
 BERRA 50 floor stand597
 BERRA 70 floor stand.....597
 BIBA 3 pendant for EASYTEC® II.....437
 BIBA III pendant065
 BIG LIGHT EYE pendant071
 BIG NAILS 50 floor stand.....591
 BIG NAILS 80 floor stand.....591
 BIG NAILS PLUS 50 floor stand591
 BIG NAILS PLUS 80 floor stand591
 BIG NAILS PLUS wall light632
 BIG NAILS wall light633
 BIG NAUTILUS SQUARE LED, wall light...691
 BIG QUAD wall light651
 BIG SUN CEILING ceiling light.....281
 BIG SUN pendant071
 BIG THEO BEAM wall light.....660
 BIG THEO CEILING ceiling light305
 BIG THEO CEILING OUT ceiling light703
 BIG THEO CEILING OUT GX53
 ceiling light700
 BIG THEO UP/DOWN OUT GX53
 wall light659
 BIG THEO UP/DOWN OUT wall light.....659
 BIG THEO UP/DOWN wall light.....237
 BIG THEO WALL OUT GX53 wall light ...659
 BIG THEO WALL OUT wall light659
 BILAS ceiling recessed light510
 BILAS SPOT, double351
 BILAS SPOT, for 3-circuit.....387
 BILAS SPOT, single.....209, 351
 BILAS SPOT, triple351
 BILAS, single spot LED, for 1-circuit.....413
 BIMA 1 lamp head for EASYTEC® II435
 BIMA 2 lamp head for EASYTEC® II435
 BIMA display light.....188
 BIMA I lamp head, for 1-circuit.....419
 BIMA I lamp head, for 3-circuit.....397
 BIMA II lamp head, for 1-circuit.....419
 BIMA II lamp head, for 3-circuit.....397
 BISHADE PD-1 pendant079
 BISHADE SL-1 floor stand044
 BISHADE TL-1 table lamp025
 BOOKAT floor stand.....561
 BOOST IP44 9W downlight.....501
 BOWTOW GLASS shelf fitting267
 BOX R7s wall light.....669
 BOX-L E27 wall light669
 BRICK DOWNUNDER E14.....711
 BRICK LED 16 STAINLESS STEEL 304
 wall light.....713
 BRICK LED 24 STAINLESS STEEL 304
 wall light.....713
 BRICK LED 24 STAINLESS STEEL 304
 wall light.....713
 BRICK LED DOWNUNDER wall light.....711
 BRICK MESH LED STAINLESS STEEL 316
 wall recessed light.....709
 BRICK MESH STAINLESS STEEL 316
 wall recessed light.....709
 BULAN ceiling light680, 695
 BULAN GRID wall light.....681, 695
- C**
- C-POL floor stand.....581
 C-POL WALL wall light.....635
 Cable extension811
 Cable feed-in for WAVE.....444
 CAMARA DOUBLE IP44 wall light259
 CAMARA IP44 wall light259
 Canopy057
 Canopy127
 Canopy for 1-circuit411
 Canopy TRON106, 110, 115, 116
 Canopy with feed-in cable
 for AIXLIGHT® PENDANT SYSTEM.....107
 CARISO, wall light229
 Ceiling deflector for LV rope system449
 Ceiling suspension flexible
 for EASYTEC® II431
 for LINUX LIGHT®.....439
 Ceiling suspension
 for 1-circuit HV track411
 for EASYTEC® II431
 for inclined ceilings for LINUX LIGHT®439
 for LINUX LIGHT®.....439
 for WAVE444
 CEILING TRANSFORMER 105VA444
 CEILING TRANSFORMER 210VA444
 CHROMBO TC-S wall light.....221
 CL 101 GX53, ceiling light.....299
 CL 135 T16 R,
 wall and ceiling light157, 297
 CLEAR CABLE.....818
 COB LED MODULE
 for AIXLIGHT® PRO installation frame.....481
 COLOR CONTROL, EASY LIM WIFI
 RGBW BLUETOOTH ADAPTER797
 COLOR CONTROL, EASY LIM WIFI
 RGBW BULB827
 COLOR CONTROL, EASY LIM WIFI
 RGBW BULB with Master function.....827
 COLOR CONTROL, EASY LIM WIFI
 RGBW REPEATER797
 COLOR CONTROL, EASY LIM WIFI
 RGBW RF remote control.....797
 COLOR CONTROL, RGBW.....797
 COLOR CONTROL, wall panel.....797
 COMET rope light451
 COMMO PD-1 pendant061
 COMMO pendant, for 1-circuit.....425
 Concrete anchor
 for outdoor fittings.....599, 600, 603
 Concrete anchor for ROX PATHLIGHT,
 DELWA PATHLIGHT.....557, 563
 Concrete anchor for SQUARE POLE,
 ROX ACRYL POLE and ARCOLOS
 UP BEAM586, 587
 Concrete anchor for VAP.....585
 Concrete anchor set for VAP SLIM,
 BERRA and SITRA SL.....589, 597
 CONE GU10 wall light.....677
 CONE outdoor light.....555
 CONE SHADE Satin/Tinto pendant089
 CONNECTION BOX IP67817
 CONNECTION BOX IP68817
 CONNECTION BOX round816
 Connection lead for HID applications812
 Connection lead,
 for outdoor LED strips.....621, 783
 Connection screws
 for AIXLIGHT® PENDANT SYSTEM.....107
 Connection/feed-in box
 for AIXLIGHT® PENDANT SYSTEM.....107
 Connector (for FLEXLED ROLL
 MULTICOLOUR 24V).....775
 Connector for GLENOS
 wall recessed profile.....750
 CONTONE® downlight497
 CONVENTIONAL TRANSFORMER 12V ...814
 CONVENTIONAL TRANSFORMER
 MANTA 200813
 CONVENTIONAL TRANSFORMER
 MANTA 300813
 CODRA pendant079
 Corner connector 90°751
 Corner connector for 1-circuit HV track,
 recessed.....409
 surface-mounted.....410
 Corner connector for HANG UP110
 Corner profile748

CORONA CI-1 ceiling light	295	DEVIN SINGLE wall light	259	EASYTEC® II track.....	431	EUTRAC® end cap for 3-circuit track.....	371
COSMIC LAMP HOLDER.....	450	DIABO PD pendant, for 1-circuit	425	ECO LED SQUARE downlight	515	EUTRAC® feed-in.....	370
COUPA FLEXLED wall light	177	DIABO SPOT 1 ceiling light	340	ELECTRONIC BALLAST HID.....	812	EUTRAC® feed-in	
Cover for 1-circuit HV track, recessed.....	409	DIABO SPOT 2 ceiling light	341	Electronic transformer	815	for 3-circuit recessed track.....	369
CREST 1 wall light.....	163	DIABO Spot, for 1-circuit	419	Electronic transformer	815	EUTRAC® feed-in	
CREST 2 wall light.....	163	DIABO Spot, for 3-circuit	397	End cap for ALU PROFILE	764	for 3-circuit recessed track.....	369
CREST pendant	117	DIO FLEX PLATE LED wall light	183	End cap for ALU RECESSED PROFILE.....	766	EUTRAC® flex connector	371
CREST wall light.....	257	DIO FLEX PLATE wall light.....	183	End cap for aluminium baseboard profile		EUTRAC® joint connector	
CRYSTAL I downlight	526	DIO FLEX PLUG.....	185	for LED	751	for 3-circuit track.....	370
CRYSTAL II downlight	527	Direct connector (for FLEXLED ROLL		End cap for CORNER PROFILE	748	EUTRAC® L-connector.....	371
CRYSTAL VIII downlight	527	MULTICOLOUR 24V).....	775	End cap for EASYTEC® II	431	EUTRAC® L-connector	
CUBIX I floor light.....	541	Direct connector for		End cap for GLENOS		for 3-circuit recessed track.....	369
CUBIX II floor light	541	FLEXLED ROLL 24V and		wall recessed profile.....	750	EUTRAC® long connector	370
CV-SPOT 120 spike light.....	608	FLEXLED ROLL PRO 12V/24V.....	774, 775	End cap for LED PENLIGHT PRO 230V.....	785	EUTRAC® long connector	
CV-SPOT 40 spike light.....	608	Direct connector		End cap for linear profile 1107.....	770	for 3-circuit recessed track.....	369
CV-SPOT 80 spike light.....	608	for FLEXLED ROLL RGB 24V.....	782	End cap for linear profile 1808.....	768	EUTRAC® long connector	
CV-SPOT WALL GU10		Direct feed-in for WAVE.....	444	End cap for linear recessed profile 2508.....	773	with feed-in option	371
wall and ceiling light	691	DISPLAY ADL 50/GU10	187	End cap for PROFILE 2020	758	EUTRAC® middle feed-in.....	370
CYGNIS PD-1, pendant	119	DISTRIBUTOR for LED spots		End caps for PROFILE 2020 HV track,		EUTRAC® pendant clip	
CYGNIS table lamp	031	in series connection	812	recessed	409	for 3-circuit track.....	371
		DL 123 LED, ceiling recessed light	525	surface-mounted.....	411	EUTRAC® pendant suspension	
		DL 126 LED, downlight	524	for GLENOS WALL PROFILE	754, 755	for 3-circuit track.....	371
		DOLIX OUT GU10 downlight.....	495, 715	End caps		EUTRAC® spring clip	
		DOLIX OUT GU10 SQUARE		for GLENOS WALL PROFILE up/down	755	for 3-circuit recessed track.....	369
		downlight	495, 715	End caps for LINUX LIGHT®.....	439	EUTRAC® steel rope suspension	371
		DOLIX OUT MR16 downlight.....	495, 715	End caps for PROFILE 2609, BRICK.....	760	EUTRAC® T-connector.....	371
		DOLIX OUT MR16 SQUARE		End caps for PROFILE 2609, DOME.....	760	EUTRAC® track socket.....	370
		downlight	495, 715	End caps for PROFILE 2609, FLAT	760	EUTRAC® universal point outlet.....	370
		DOMELED spot, for 3-circuit.....	375	End caps for PROFILE 2609, X-connector.....	371	Extension rod	
		Double-sided adhesive tape 9 mm.....	446	End caps for WAVE.....	444	for NEW MYRA 1 & 2 lamp heads	603, 606
		DOWNUNDER 05,		End piece/earth spike		Extension rod	
		wall and ceiling recessed light	529	for NEW MYRA 1 & 2 lamp heads.....	606	for PLENUM FIX floor stands.....	600
		DOWNUNDER III		ENERGY PACK	818	EYEDOWN LED downlight	503
		wall and ceiling recessed light	529	ENOLA pendant.....	053		
		DOWNUNDER LED 14 wall light	712	ENOLA_B wall light torch	239		
		DOWNUNDER LED 14 wall light	712	ENOLA_B CL-1 ceiling light.....	307		
		DOWNUNDER LED 15 wall light	712	ENOLA_B double,			
		DOWNUNDER LED 15 wall light	712	wall and ceiling light	199, 341		
		DOWNUNDER LED 27 wall light	712	ENOLA_B PD-1 pendant	053		
		DOWNUNDER OUT LED L,		ENOLA_B pendant, for 1-circuit.....	425		
		wall recessed light.....	710	ENOLA_B single,			
		DOWNUNDER OUT LED M,		wall and ceiling light	199, 340		
		wall recessed light.....	710	ENOLA_B SPOT double,			
		DOWNUNDER OUT LED S,		wall and ceiling light	343		
		wall recessed light.....	710	ENOLA_B SPOT single,			
		DOWNUNDER OUT TC-D.....	713	wall and ceiling light	343		
		DOWNUNDER PUR recessed light.....	531	ENOLA_B UP/DOWN wall light	254		
		Downunder, RCL 101	528	ENOLA_C 18 Spot, for 3-circuit	374		
		DP 118 R7s, mirror light.....	263	ENOLA_C 9 Spot, for 3-circuit	374		
		DRAGAN SENSOR		ENOLA_C OUT CL LED ceiling light	305		
		wall and ceiling light	683, 697	ENOLA_C CURVED display light.....	689		
		DRAGAN wall and ceiling light.....	683, 697	ENOLA_C OUT POLE floor stand.....	563		
		DURANZ pendant	116	ENOLA_C OUT CL ceiling light.....	703		
				ENOLA_C OUT UP-DOWN wall light	647		
				ENOLA_C OUT WL wall light.....	647		
				ENOLA_C SPOT 1 LED ceiling light.....	349		
				ENOLA_C Spot, for 1-circuit	412		
				EP1 DIMMER 1-10V, max. 10W.....	803		
				ES111 MODULE			
				for AXILIGHT® PRO installation frame.....	480		
				EURO CUBE spot, for 3-circuit	373		
				EURO SPOT ELECTRONIC BALLAST			
				for 3-circuit	383		
				EURO SPOT ELECTRONIC BALLAST,			
				for 3-circuit	383		
				EURO SPOT ES111, for 1-circuit	415		
				EURO SPOT ES111, for 3-circuit	385		
				EURO SPOT G12, for 3-circuit	383		
				EURO SPOT GU10, for 1-circuit.....	415		
				EURO SPOT GU10, for 3-circuit.....	385		
				EURO SPOT LED DISK 800,			
				for 1-circuit	412		
				EURO SPOT LED DISK 800,			
				for 3-circuit	379		
				EURO SPOT LED, for 3-circuit	381		
				EURO SPOT QRB111, for 3-circuit	385		
				EUROSPOT INTEGRATED LED,			
				for 1-circuit	412		
				EUROSPOT INTEGRATED LED,			
				for 3-circuit	379		
				EUTRAC® 3-circuit recessed track	369		
				EUTRAC® 3-circuit track	370		
				EUTRAC® 3-circuit			
				track adapter.....	057, 370, 404		
				EUTRAC® end cap			
				for 3-circuit recessed track.....	369		

D

D-RECTION 70W G12 Spot,	
for 3-circuit	389
D-TECT E27 ceiling light.....	157, 284
D-TECT LED ceiling light	155, 284
DACU SPACE wall light	227
DACU UP-DOWN.....	657
DACU UP-DOWN LED BEAM wall light	657
DACU UP-DOWN LED wall light.....	657
DARIUS wall and ceiling light	163
DASAR 115 GU10 inground fitting	733
DASAR 115 LED inground fitting.....	725
DASAR 115 MR16.....	731
DASAR 215 UNI inground fitting.....	736
DASAR 260 UNI inground fitting.....	736
DASAR BULLSEYE QRB111	
inground fitting	735
DASAR ES111 inground fitting	735
DASAR EXACT GU10 inground fitting.....	733
DASAR EXACT MR16 inground fitting	731
DASAR FLAT LED inground fitting	725
DASAR GX53 inground fitting.....	725
DASAR HIT-T 70W inground fitting	739
DASAR HQI SQUARE 70W	
inground fitting	738
DASAR LED HV inground fitting	720
DASAR LED HV PRO inground fitting	720
DASAR LED LV inground fitting	721
DASAR LED LV PRO inground fitting.....	721
DASAR LED MINI, inground fitting.....	723
DASAR LED SQUARE inground fitting.....	738
DASAR MODULE LED inground fitting	727
DASAR SQUARE GU10,	
inground fitting	733
DASAR T5-14 FLOOR PROFILE.....	737
DASAR T5-21 FLOOR PROFILE.....	737
DEBASTO single spot, for 1-circuit.....	418
DEBASTO wall and ceiling light	199, 348
DEBASTO, 7W LED COB ceiling light.....	348
DEBASTO, for 3-circuit.....	399
Deco ring 51 for GU10, smooth	187, 189
Deco ring 51mm	
for GU10.....	067, 183, 185, 187, 207, 333
Deco ring for ENOLA_B	
.....	199, 239, 254, 307, 340, 341, 343
Deco ring for ES111 and QRB	187, 189
Deco ring for SLEEK SPOT G12.....	389
Deco ring with structured diffuser	
for ENOLA_C range	305, 349, 374, 412
Deflector for LV rope system	449
DEKLED recessed light	522
DELFC 100 PRO light bar	745
DELFC 1000 PRO light bar	745
DELFC 1000 RGB PRO light bar.....	745
DELFC 1200 PRO light bar	745
DELFC 200 PRO light bar	745
DELFC 500 PRO light bar	745
DELFC 500 RGB PRO light bar.....	745
DELWA CURVE wall light	649
DELWA PATHLIGHT floor stand	557
DELWA wall light	242, 653
DELWA WIDE wall light	242, 653
DENA I wall light.....	250
DENA II wall light	250
DETT outdoor light.....	551
DEVIN DOUBLE wall light.....	259

E

E27 SPOT, for 3-circuit.....	400
Earth spike for ARROCK ARC GU10.....	575
Earth spike	
for ARROCK SLOT GU10.....	573, 575
Earth spike for BACCO 70/90	561, 573
Earth spike for EASYLITE SPOT	
and display lights	618, 627
Earth spike for GRAFIT SL, RUSTY SLOT,	
LOGS40 and LOGS70	559, 571, 587
Earth spike for IPERI 50	557
Earth spike	
for outdoor fittings.....	599, 600, 603
Earth spike for ROX ACRYL POLE,	
ARCOLOS UP BEAM, SQUARE POLE	
and GLOO PURE	586, 587, 597
Earth spike for ROX PATHLIGHT,	
DELWA PATHLIGHT.....	557, 563
Earth spike for RUSTY	567
Earth spike for RUSTY CONE 40 / 70	569
Earth spike for RUSTY SQUARE,	
RUSTY PATHLIGHT, ARROCK 40/70.....	
.....	565, 569, 577
Earth spike for TRUST, NAILS,	
BIG NAILS, BIG NAILS PLUS	
and ENERGY PACK	591, 593
Earth spike for VAP SLIM, BERRA,	
SITRA 360 SL and SITRA SL.....	589, 597, 601
EASY LIM RF MINI RGB	805
EASY LIM RF MINI SINGLE COLOUR	805
EASYLITE SPIKE GU10.....	611
EASYLITE SPOT G12.....	627
EASYLITE SPOT GU10	618, 692, 706

F

F-POL floor stand.....	581
F-POL WALL wall light	635
Feed-in (for FLEXLED ROLL	
MULTICOLOUR 24V).....	775
Feed-in cable	
for DELFC PRO light bar	745
Feed-in cable,	
for outdoor LED strips.....	621, 783
Feed-in for 1-circuit HV track,	
recessed	409
surface-mounted.....	410
Feed-in for EASYTEC® II.....	431
Feed-in for FLEXLED ROLL 24V and	
FLEXLED ROLL PRO 12V/ 24V.....	774, 775
Feed-in for FLEXLED ROLL RGB 24V	782
Feed-in for LINUX LIGHT®.....	439
Feed-in for LV rope system.....	449
Feed-in set	
for LED PENLIGHT PRO 230V	785
Feed-in/long connector for GLU-TRAX®	446
FENDA ceiling light.....	277
FENDA cover	075, 277
FENDA lamp shade	021, 075, 277
FENDA pendant suspension	075
FENDA table lamp.....	021
FILU display light.....	189
FILU display light.....	187
FITU E27 pendant	057, 404, 424
FLAC BEAM floor light.....	627
FLAC BEAM LED	627
FLAT 121 wall light	267
FLAT 221 wall light	267
FLAT FRAME BASIC, recessed light.....	532
Flex connector for 1-circuit HV track	411
Flex connector	
for DELFC PRO light bar	745
Flex connector for EASYTEC® II	431
Flex connector L for LINUX LIGHT®.....	439
Flexible ceiling holder for roof slope	
for EASYTEC® II	431
Flexible long connector for GLU-TRAX®	446
FLEXLED ROLL	778
FLEXLED ROLL 3D.....	776
FLEXLED ROLL HIGH LUMEN	775
FLEXLED ROLL HIGHEND	777
FLEXLED ROLL MULTICOLOUR	775
FLEXLED ROLL SELECT	774
FLEXLED ROLL SLIM	777
FLOODI, (RF) flood light.....	622
Flush-mounted frame	
for DOWNUNDER 05	529

- Flush-mounted frame
for DOWNUNDER 2 and 3529
- Flush-mounted frame
for DOWNUNDER RCL 101528
- Flush-mounted frame for FOK LED, FRAME,
FLAT FRAME and BASIC LED range532
- Flush-mounted frame for GLENOS LED534
- MINI TRANSFORMER 1815
- FORCHINI M PD-1 pendant083
- FORCHINI M PD-2 pendant083
- FORCHINI M pendant, for 1-circuit429
- FORCHINI M pendant, for 3-circuit403
- FORCHINI PD-1 pendant083
- FORCHINI PD-2 pendant083
- FRAME BASIC LED recessed light533
- FRAME BASIC LED recessed light533
- FRAME BASIC, LED Set, downlight499
- FRAME CONNECTOR
for AXLIGHT® PENDANT SYSTEM107
- FRAME CURVE LED recessed light533
- FRAME OUTDOOR 16 LED
wall recessed light713
- G**
- G12 MODULE for AXLIGHT® PRO
installation frame481
- G6, 35 HALOGEN SOCKET819
- GALEN LED PROFILE621
- GERMA ceiling light679, 699
- GLALED wall light537
- GIMBLE OUT 90 floor light729
- GIMBLE PRO G12
ceiling recessed light511
- GL 100 SLOT, wall light235
- GL 101 E14, wall light241
- GL 102 CURVE, wall light222
- GL 103 T5, wall light223
- GL 104 E27, ceiling light293
- GL 105 E27, ceiling light293
- GL 108 INDI, recessed light498, 539
- GL 110 MR16,
ceiling recessed light498, 539
- GLASSA ROUND E27
ceiling light157, 287
- GLASSA SQUARE E27
ceiling light167, 287
- GLASSA SQUARE TC-DE
ceiling light167, 287
- Glenos acrylic cover
for Square PROFILE 3030762
- GLENOS acrylic cover
for STEP PROFILE DOWN753
- GLENOS ALU PROFILE 4970764
- GLENOS ALU RECESSED
PROFILE 8832766
- GLENOS end cap
for STEP PROFILE DOWN753
- GLENOS end caps for profile 3030762
- GLENOS end caps
for SHELF PROFILE746, 747
- GLENOS LED, wall recessed light534
- GLENOS professional profile 2020758
- GLENOS professional
wall bracket profile756
- GLENOS profile 2508775
- GLENOS profile 2609, 1m760
- GLENOS shelf profile746
- GLENOS square profile 3030, 1m762
- GLENOS STEP PROFILE DOWN753
- GLENOS STEP PROFILE UP752
- GLENOS WALL PROFILE754
- GLENOS WALL PROFILE up/down755
- GLENOS wall recessed profile
asymmetrical750
- GLOO PURE 27 floor stand597, 705
- GLOO PURE 44 floor stand597
- GLOO PURE 70 floor stand597
- GLOO PURE WALL wall light637
- GLU-TRAX® track446
- GRAFIT SL 30 floor stand587
- GRAFIT SL 60 floor stand587
- GRAFIT TORCH wall light632
- GRAFIT WL wall light635
- GU10 MODULE for AXLIGHT® PRO 50
installation frame483
- GU10 socket819
- GU10 SP downlight491
- GU10 SP SQUARE downlight491
- Gutter clips
for LED PENLIGHT PRO 230V785
- GX53 SPOT for EASYTEC® II432
- H**
- HANG UP grid light110
- HARI wall light223
- HIBIT display light187
- Holder for 1-circuit HV track, recessed409
- HORN -A GU10487
- HORN -T GU10487
- HORN 2 TURNO ES111 downlight489
- HORN 2 TURNO GU10
ceiling recessed light486
- HORN 2 TURNO MR16
ceiling recessed light484
- HORN 2 TURNO QRB111 downlight485
- HORN ES111 downlight489
- HORN GU10 downlight486
- HORN MR16 downlight484
- HORN QRB111 downlight485
- I**
- I-LINE TOUCH floor stand037
- I-PENDANT PRO LED PANEL
pendant127, 361
- I-RING FLOOR, floor stand039
- I-RING pendant058
- I-RING WALL, wall light158
- I-VIDUAL LED PANEL for grid ceilings518
- INDA SPOT GU10 wall and ceiling light335
- INDI REC 1S, downlight493
- INDI REC 2S, downlight493
- INDIGLA wall light167, 289, 683
- INDIGLA WING289, 697
- Installation box for BEDSIDE wall light536
- Installation box for FOK LED, FRAME,
FLAT FRAME and BASIC LED range532
- Installation frame
for DOWNUNDER PUR531
- Installation frame
for LED DOWNUNDER MINI530
- IP 68 T CONNECTION BOX817
- IP FLEXLED ROLL RGB783
- IP HORN487
- IP44 TRANSFORMER 10VA, 12V813
- IP44 TRANSFORMER 150VA, 12V813
- IP44 TRANSFORMER 60VA, 12V813
- IP68 CONNECTION BOX817
- IP68 connector 2, 5qmm817
- IPERI 50 floor stand557
- IPERI WL wall light675
- Isolation connector for LINUX LIGHT®439
- Isolation connector for LV rope system449
- ISTU pendant143
- IVED GOOSE CANOPY183
- IVED GOOSE RECESSED537
- K**
- KADUX LED triple DL set, 38°472
- KADUX 1 ES111 downlight471
- KADUX 1 GU10 downlight471
- KADUX 2 ES111 downlight471
- KADUX 2 GU10 downlight471
- KADUX 3 ES111 downlight471
- KADUX 3 GU10 downlight471
- KADUX LED double DL set, 30°473
- KADUX LED double DL set, 38°472
- KADUX LED single DL set, 30°473
- KADUX LED single DL set, 38°472
- KALU LED 4 Wide Line
wall and ceiling light216, 330
- KALU 1 QPAR ceiling light215, 329
- KALU 1 wall and ceiling light213, 325
- KALU 2 QPAR ceiling light215, 329
- KALU 2 wall and ceiling light213, 325
- KALU 3 QPAR ceiling light215, 329
- KALU 3 wall and ceiling light213, 327
- KALU FLOOR 1 floor stand038
- KALU FLOOR 2 floor stand038
- KALU II ES111 DOUBLE
wall and ceiling light211, 321
- KALU II ES111
wall and ceiling light211, 321
- KALU LED 1 FLOOR, floor stand039
- KALU LED 1 wall and ceiling light217, 331
- KALU LED 2 FLOOR, floor stand039
- KALU LED 2 wall and ceiling light217, 331
- KALU LED 3 wall and ceiling light217, 331
- KALU LED 4 long
wall and ceiling light217, 331
- KALU LED 4 square
wall and ceiling light216, 330
- KALU RECESSED 1 recessed light512
- KALU RECESSED 2 recessed light512
- KALU RECESSED 3 recessed light512
- KALU recessed light, 1 spot513
- KALU TRACK LEDDISK lamp head,
for 3-circuit377
- KALU TRACK LEDDISK spot,
for 1-circuit417
- KALU TRACK QPAR111 lamp head,
for 1-circuit417
- KALU TRACK QPAR111 lamp head,
for 3-circuit377
- KALU TRACK QRB111 spot,
for 1-circuit417
- KALU TRACK QRB111, for 3-circuit377
- KANO lamp head for EASYTEC® II433
- KARDAMOD SURFACE ROUND ES111
DOUBLE ceiling light313
- KARDAMOD SURFACE ROUND ES111
SINGLE ceiling light313
- KARDAMOD SURFACE ROUND QRB
DOUBLE ceiling light313
- KARDAMOD SURFACE ROUND QRB
SINGLE ceiling light313
- KARDAMOD SURFACE SQUARE ES111
DOUBLE ceiling light311
- KARDAMOD SURFACE SQUARE ES111
SINGLE ceiling light311
- KARDAMOD SURFACE SQUARE QRB
DOUBLE ceiling light311
- KARDAMOD SURFACE SQUARE QRB
SINGLE ceiling light311
- KASPO lamp head, for 1-circuit418
- KERAS ELT wall light684
- KUNO CEILING ceiling light363
- KUNO pendant115
- KYKLOP POLE floor stand555
- KYKLOP WALL wall light655
- L**
- L-LINE 120 wall and ceiling light265
- L-LINE 60 wall and ceiling light265
- Lamp adapter, mechanical370
- LAMP PLIERS819
- LASSON PD-1 pendant073
- LASSON PD-2 pendant051
- LASSON PD-3 pendant076
- LASSON WL-2 wall light171
- LASSON WL-3 wall light171
- LED ALUMINIUM downlight524
- LED DISK MODULE
for AXLIGHT® PRO installation frame481
- LED DISPLAY display light191
- LED downlight 14/3504
- LED downlight 14/4504
- LED downlight 30/3505
- LED downlight 30/4505
- LED downlight 36/3505
- LED downlight 36/4505
- LED downlight 60/3505
- LED downlight 60/4505
- LED DOWNUNDER MINI
wall recessed light530
- LED DOWNUNDER ROUND wall light654
- LED drivers807-810
- LED FLOOD LIGHT624
- LED LIGHTPOINT recessed light523
- LED OUTDOOR BEAM614, 623
- LED PANEL
ceiling recessed light127, 361, 519
- LED PANEL for grid ceilings127, 361, 519
- LED PANEL ROUND 60518
- LED PANEL ROUND, pendant139
- LED PENLIGHT PRO 230V785
- LED picture light STRIP195
- LED POWER SUPPLY UNIT806
- LED POWER SUPPLY UNIT 3x
dimable 1-10V803
- LED POWER SUPPLY UNIT SOCKET
INSTALLATION805
- LED RECESSED PROFILE 1612770
- LED RECESSED PROFILE 2212772
- LED SAIL 1 wall light249
- LED SAIL 2 wall light249
- LED SLIM LIGHT recessed light525
- LED SPOT for MINI ALU TRACK447
- LED strip clip connector774, 775, 776
- LED STRIP OUTDOOR621
- LED SURFACE-MOUNTED SPOT299
- LED WALL POWER SUPPLY805
- LEDDISK HORN DL downlight501
- LEDPANEL 100 downlight515
- LEDPANEL 100 SMD,
ceiling recessed light515
- LEDPANEL 100 SMD,
surface-mounted ceiling light301
- LEDPANEL 100 SMD,
surface-mounted ceiling light301
- LEFA 1 pendant061
- LEFA 1 wall and ceiling light197, 342
- LEFA 2 wall and ceiling light197, 342
- LEFA 4 pendant121
- LIGHT EYE 1 GU10
wall and ceiling light207, 333
- LIGHT EYE 2 GU10
wall and ceiling light207, 333
- LIGHT EYE BALL GU10 pendant067
- LIGHT EYE BALL wall light209
- LIGHT EYE ES111 SPOT
for EASYTEC® II435
- LIGHT EYE GU10 SPOT
for EASYTEC® II435
- LIGHT EYE GU10 Spot, for 1-circuit423
- LIGHT EYE pendant067
- LIGHT EYE PENDANT ES111
for EASYTEC® II436
- LIGHT EYE pendant ES111,
for 1-circuit423
- LIGHT EYE PENDANT
for EASYTEC® II436
- LIGHT EYE pendant GU10,
for 1-circuit422
- LIGHT EYE pendant,
for 3-circuit403
- LIGHT EYE SPOT MR16
for LINUX LIGHT®440
- LIGHT EYE SPOT, for 3-circuit401
- LIGHT EYE wall and ceiling light209, 333
- LIGHT EYE X3 pendant068
- LIGHTPOINT downlight523
- LIKA lamp head for LINUX LIGHT®443
- LIKA lamp head for LINUX LIGHT®443
- LIM 2 CONTROLLER803
- Linear profile 1107770
- Linear profile 1809768
- LIPSY® 30 LED ceiling light153, 283
- LIPSY® 36 M COLOR CONTROL
ceiling light150, 285, 796
- LIPSY® 36 S COLOR CONTROL
ceiling light150, 285, 796
- LIPSY® 40 LED ceiling light153, 283
- LIPSY® 50 LED ceiling light153, 283
- LIPSY® 50 M COLOR CONTROL
wall and ceiling light151, 285, 796
- LIPSY® 50 S COLOR CONTROL
wall and ceiling light151, 285, 796
- LIPSY® OUT FLOOR outdoor light551
- LISENNE-O, ceiling light705
- LISENNE-O, table lamp541
- LOGS 40 floor stand559
- LOGS 70 floor stand559
- LOGS IN wall light230
- LOGS WALL wall light652
- Long connector for 1-circuit HV track410
- Long connector for 1-circuit HV track,
surface-mounted409
- Long connector for EASYTEC® II431
- Long connector for HANG UP110
- Long connector
for LED PENLIGHT PRO 230V785
- Long connector for LINUX LIGHT®439
- Long connector for LINUX LIGHT®439
- Long connector for PROFILE 2020758
- Long connector for Q-LINE WALL113, 270
- Long connector isolated
for EASYTEC® II431

LONG GRILL CEILING, ceiling light	365
LONG GRILL pendant	109
LOUISSE 1 ceiling light	288
LUZO LED DISK, ceiling recessed ring	501
LV distributor box	819
LV rope, isolated	449
LYNAH LED pendant	099
LYNAH LED wall light	219
LYNAH, double, for 3-circuit	375
LYNAH, LED double spot, for 1-circuit	414
M	
MALANG ceiling light	281
MALANG LED pendant	141
MECANICA floor stand	037
MECANICA table lamp	031
MEDO 40 LED, ceiling light	135, 356
MEDO 40 LED, recessed	507
MEDO 40 LED, recessed, no visible frame	506
MEDO 60 LED, recessed, no visible frame	506
MEDO 60 LED, ceiling light	135, 356
MEDO 60 LED, recessed	507
MEDO 60 SQUARE ceiling light	131, 353
MEDO 60 SQUARE suspension set	131, 353, 355
MEDO ceiling light	297
MEDO LED, ceiling light	297
MEDO LED, pendant	143
MEDO pendant	143
MEDO PRO 40 ceiling light	133, 355
MEDO PRO 60 ceiling light	133, 355
MEDO PRO 60 suspension set	133, 135
MEDO PRO 90 ceiling light	133
MEDO PRO 90 ceiling light	133
MEDO PRO suspension set	135
MEDO RING 60, pendant	137
MEDO RING 90, pendant	137
MELAN ceiling light	155, 295
MERIDIAN 2 wall light	685
MERIDIAN 3 wall light	687
MERIDIAN BOX 2 outdoor light	687
MERIDIAN BOX outdoor light	686
MERIDIAN BOX wall light	686
MERVALED S wall light	693
MERVALED wall light	693
MIBO CURVE mirror light	263
MIBO STRAIGHT mirror light	263
MIBO WALL UP-DOWN	261
MICRO FLAT outdoor light	680, 701
MINI ALU TRACK feed-in	446
lead-through for shelves	446
long connector	446
mounting clips	446
track	446
MINI FRAME LED, recessed light	535
MOLDI 32 ceiling light	295
MOLDI 46 ceiling light	295
Motion sensor infrared IP44	818
Motion sensor microwave IP44	818
Mounting bracket for ALU RECESSED PROFILE	766
Mounting brackets for LED Strips Outdoor	621, 783
Mounting clips for DELF C PRO light bar	745
Mounting clips for GLU-TRAX® track	446
Mounting clips for LED PENLIGHT PRO 230V	785
MOUNTING CLIPS for PROFILE 1808	768
Mounting holder for GLENOS WALL PROFILE	754, 755
Mounting plate for MYRALED WALL, ENOLA_C OUT	645, 647, 688, 689, 707
Mounting spring for corner profile	748
Mounting spring for GLENOS wall recessed profile	750
MR16 MODULE for AXLIGHT® PRO 50 installation frame	483
Multi-way connector	811
MYRA CURVED display spot	689
MYRA STRAIGHT display spot	688
MYRALED WALL	645, 707
N	
N-TIC PRO GU10 recessed spot	732
N-TIC PRO MR16	730
N-TIC SPOT 230V wall and ceiling light	335
NAILS floor stand	593
NAILS SPIKE floor stand	610
NAILS wall light	633
NAPIA TWIN wall light	179
NAPIA wall light	178
NAUTILUS GX53 STAINLESS outdoor spot	619
NAUTILUS IP67	619
NAUTILUS LED 304B	617, 692, 706
NAUTILUS LED 304S	612
NAUTILUS MR16 STAINLESS STEEL 304	619
NAUTILUS PAR38 STAINLESS STEEL	618
NAUTILUS SPIKE	613
NAUTILUS SPIKE LED COMPACT	615
NAUTILUS SPIKE STAINLESS STEEL	613
NAUTILUS SPIKE XL	613
NAUTILUS SQUARE LED wall light	691
NEAT display light	188
NEAT FLEX CLAMP display light	189
NEOPAN wall and ceiling light	169, 357
NEPRO DISPLAY	191
NEPRO LINE wall light	271
NEW MYRA 1 lamp head	603, 606
NEW MYRA 2 lamp head	603, 606
NEW MYRA DISPLAY CURVE	689
NEW MYRA DISPLAY STRAIGHT	688
NEW MYRA UP/DOWN wall light	645
NEW MYRA WALL SPOT wall light	645, 707
NEW MYRA WALL wall light	645, 707
NEW POL outdoor fitting	585
NEW POL outdoor fitting	585
NEW SURA pendant for WAVE	445
NEW TRIA 2 DL SQUARE set	467
NEW TRIA 3 DL SQUARE set	467
NEW TRIA 68 GU10 ROUND	464
NEW TRIA 68 GU10 SQUARE	464
NEW TRIA 68 LED DL ROUND Set	465
NEW TRIA 68 LED DL SQUARE Set	465
NEW TRIA DL ROUND set, downlight	466
NEW TRIA DL SQUARE set, downlight	466
NEW TRIA DLMI ROUND downlight	468
NEW TRIA DLMI SQUARE downlight	468
NEW TRIA ES111 downlight	463
NEW TRIA GU10	460
NEW TRIA GU10 ROUND downlight	461
NEW TRIA I ES111	463
NEW TRIA I ES111	463
NEW TRIA I ES111 SQUARE	463
NEW TRIA I GU10 downlight	460
NEW TRIA I GU10 downlight	461
NEW TRIA I GU10 ROUND downlight	461
NEW TRIA I GU10 SQUARE downlight	461
NEW TRIA I MR16 downlight	457
NEW TRIA I MR16 downlight	456
NEW TRIA I MR16 downlight	457
NEW TRIA I MR16 downlight	457
NEW TRIA I QRB111 downlight	459
NEW TRIA I QRB111 SQUARE	459
NEW TRIA I QRB111 SQUARE	459
NEW TRIA II ES111	463
NEW TRIA II ES111 SQUARE	463
NEW TRIA II ES111 SQUARE	463
NEW TRIA II GU10 downlight	461
NEW TRIA II GU10 SQUARE downlight	461
NEW TRIA II MR16 downlight	457
NEW TRIA II MR16 downlight	457
NEW TRIA II MR16 downlight	459
NEW TRIA II QRB111 downlight	459
NEW TRIA II QRB111 SQUARE	459
NEW TRIA II QRB111 SQUARE	459
NEW TRIA III ES111	463
NEW TRIA III ES111 SQUARE	463
NEW TRIA III ES111 SQUARE	463
NEW TRIA III GU10 downlight	461
NEW TRIA III GU10 SQUARE downlight	461
NEW TRIA III MR16 downlight	457
NEW TRIA III MR16 downlight	457
NEW TRIA III MR16 downlight	459
NEW TRIA III QRB111 downlight	459
NEW TRIA III QRB111 SQUARE	459
NEW TRIA III QRB111 SQUARE	459
NEW TRIA LED 3W DL ROUND set, downlight	466
NEW TRIA LED 3W DL SQUARE set, downlight	466
NEW TRIA LED DISK downlight	468
NEW TRIA LED DISK ROUND	468
NEW TRIA LED DL ROUND set	469
NEW TRIA LED DL SQUARE set	469
NEW TRIA MINI DL ROUND SET, downlight	465
NEW TRIA MINI DL ROUND, downlight	465
NEW TRIA MINI DL SQUARE	465
NEW TRIA MINI DL SQUARE set	465
NEW TRIA MR16 ROUND downlight	457
NEW TRIA MR16 ROUND downlight	456
NEW TRIA MR16 ROUND downlight	457
NEW TRIA QRB111	459
NEW TRIA XL ROUND GU10 downlight	464
NEW TRIA XL SQUARE GU10 downlight	464
NOVA LED WALL OUT wall light	671
NOVA WALL OUT wall light	671
O	
OCCULDAS, ceiling recessed light	508
OCCULDAS, surface-mounted ceiling light	298
OPEN GRILL pendant	129
OPEN GRILL SINGLE TWIST, pendant	115
OPEN GRILL wall and ceiling light	169, 357
ORDI, wall light	674
ORION CONE pendant	088
ORION pendant for LINUX LIGHT®	443
ORION S pendant	088
OSRAM MOUSE	816
OSSA R7s 300 wall light	225
OSSA R7s wall light	225
OTOS GLASS floor stand	583
OTOS PL floor stand	583
OUT 65 downlight	717
OUT 65 LED DL ROUND set downlight	716
OUT 65 LED DL SQUARE set downlight	716
OUT BEAM G8, 5, wall light	663
OUT BEAM G9 wall light	665
OUT BEAM LED wall light	663
OUT BEAM R7s, wall light	663
OVIS wall light	253
OVO ES111 pendant	063
P	
PADI LED 600 light bar	744
PARA 380 reflector lamp	094
PARA CONE 14 pendant, for 1-circuit	427
PARA CONE 14 pendant, for 3-circuit	403
PARA CONE 20 pendant	091
PARA CONE 30 pendant	091
PARA CONE 40 pendant	091
PARA CONE 40 pendant	091
PARA DOME 2 HIE	097
PARA DOME 2 pendant	095
PARA LED pendant	095
PARA MULTI 406 BALLAST pendant	096
PARA MULTI 406 pendant	095
PARA MULTI DLMI pendant	096
PATTA-F, ceiling recessed light	499, 717
PATTA-I, ceiling recessed light	499, 717
PEMA LED wall light	160, 655
PEMA SQUARE wall light	671
PEMA wall light	671
Pendant adapter for EASYTEC® II	431
Pendant adapter for LINUX LIGHT®	439
PENTULI LED pendant 24	097
PENTULI LED pendant 38	096
PERFECT DIMMING SYSTEM, inverter	799
PERFECT DIMMING SYSTEM, LED driver	799
PHELIA pendant	059
Philips ELECTRONIC BALLAST HID	812
Philips LED DRIVER 10W	808
Philips LED DRIVER 30W	811
PHO wall light	537
Picture light 13W	195
Picture light 8W	195
PIKA downlight	494
PIPOFLEX wall light	183
PIRUS pendant	065
PL MODULE for AXLIGHT® PENDANT SYSTEM	106
PL SURFACE-MOUNTED SPOT	299
Plastic earth spike	622, 623, 624
PLASTRA BOX 1 ceiling light	303
PLASTRA BOX 2 ceiling light	303
PLASTRA BOX 3 ceiling light	303
PLASTRA CL-1, ceiling light	303
PLASTRA Cone, pendant	063
PLASTRA CUBE wall light	234
PLASTRA GL 104 ROUND, wall light	251
PLASTRA GL 105 TORCH, wall light	243
PLASTRA PD-1, pendant	069
PLASTRA SQUARE wall light	247
PLASTRA Tube, pendant	061
PLASTRA TUBE, wall light	251
PLASTRA WL-1, wall light	235
PLENUM FIX floor stand	600
PLENUM MOVE floor stand	547
PLENUM SWING pendant	547
PLUG STONE/CONCRETE for baseboard profile for LED	751
POLE PARC 150 floor stand	579
POLE PARC 200 floor stand	579
POWER LIM 2 RGB Master controller	804
POWER LIM 2 RGB Slave controller	804
POWER TRAIL-LITE	723
POWER-LED SPOT for GLU-TRAX®	447
Professional transformer HOLE	816
PROFUNO LED spot, for 1-circuit	413
PROFUNO, LED spot, for 3-circuit	373
PURI 1 ceiling light	203, 337
PURI 2 ceiling light	203, 337
PURI 3 ceiling light	203, 337
PURI lamp head, for 1-circuit	421
PURI lamp head, for 3-circuit	399
PURIA spot, for 1-circuit	418
PWM converter	803
Q	
Q-LINE DOUBLE pendant	113
Q-LINE SINGLE pendant	113
Q-LINE WALL wall light	270
QRB MODULE for AXLIGHT® PRO installation frame	480
QRB MODULE MOVE for AXLIGHT® PRO	480
QRB SPOT for LINUX LIGHT®	440
QRB SPOT for LINUX LIGHT®	440
QRB SPOT for WAVE	445
QUAD 1 wall light	233, 651
QUAD 1 XL, wall light	233, 651
QUAD 2 wall light	233, 651
QUAD 2 XL, wall light	233, 651
QUADRASYL 44D outdoor light	656, 700
QUADRASYL D outdoor light	700
QUADRASYL SL 75 floor stand	595
QUADRASYL WL 15 wall light	667
R	
Reflector cover 330 for PARA DOME 2 E27 and HQI	095, 097
Reflector cover 480 for PARA DOME 2 E40	097
Reflector for AXLIGHT® DUO and R2 DUO HQI	100
Reflector for BERET G12 and DIVIS G12 downlight	511
Reflector for D-RECTION 70W G12 and D-RECTION ELITE 50W G12 Spots	389
Reflector for GIMBLE PRO G12	511
Reflector for SUPROS	093, 349, 509
Reflector for WORK LIGHT FLOOR	033
Remote control for LIM 2 CONTROLLER	803
Remote control for POWER LIM 2 Master controllers	804
RETROSIX QRB 1 wall and ceiling light	317
RETROSIX QRB 2 wall and ceiling light	317
RETROSIX QRB 3 wall and ceiling light	317
RGB FLOOD 30W	622
RIOTTE WALL wall light	175
ROBOT 2 lamp head for GLU-TRAX®	447
ROCCI, inground fitting	727
ROPE LIGHT MR16	450
ROPE LIGHT QRB	451
Rope suspension for LINUX LIGHT®	439
Rope tensioner for LV rope system	449
ROTOBALL 25 pendant	144
ROTOBALL 40 pendant	145

ROTOBALL 50 pendant145
 ROTOBALL FLOOR 25 outdoor light550
 ROTOBALL FLOOR 40 outdoor light550
 ROTOBALL FLOOR outdoor light550
 ROTOBALL HIT pendant145
 ROTOBALL SWING 25, pendant549
 ROTOBALL SWING 40, pendant549
 ROTOBALL SWING 50, pendant549
 ROUND TRANSFORMER 20VA, 12V814
 ROUND TRANSFORMER 35VA, 12V814
 ROX ACRYLIC C705
 ROX ACRYLIC POLE 30 floor stand586
 ROX ACRYLIC POLE 60 floor stand586
 ROX ACRYLIC POLE 90 floor stand586
 ROX ACRYLIC SINGLE wall light636
 ROX ACRYLIC UP-DOWN wall light636
 ROX CEILING GX53 OUT701
 ROX CEILING OUT ceiling light305, 702
 ROX LED UP-DOWN641
 ROX PATH LIGHT GX53, floor stand563
 ROX PATHLIGHT floor stand563
 ROX PRO G8, 5 wall light647
 ROX UP/DOWN GX53 OUT wall light639
 ROX UP/DOWN OUT wall light255, 639
 ROX WALL GX53 OUT wall light639
 ROX WALL OUT wall light255, 639
 RUSTY 40 LED ROUND,
 outdoor fitting567
 RUSTY 40 LED SQUARE,
 outdoor fitting565
 RUSTY 40 outdoor fitting567
 RUSTY 50 LED SLOT,
 outdoor fitting571
 RUSTY 70 LED ROUND,
 outdoor fitting567
 RUSTY 70 LED SQUARE,
 outdoor fitting565
 RUSTY 70 outdoor fitting567
 RUSTY 80 LED SLOT, outdoor fitting571
 RUSTY CONE 40 outdoor fitting569
 RUSTY CONE 70 outdoor fitting569
 RUSTY CONE outdoor fitting569
 RUSTY PATHLIGHT floor stand569
 RUSTY SLOT 50571
 RUSTY SLOT 80571
 RUSTY SQUARE 40 outdoor fitting565
 RUSTY SQUARE 70 outdoor fitting565

S

SAIL lamp head for LINUX LIGHT®443
 SALUNA rope light451
 Screws stainless steel M5559,
 Screws stainless steel M6600, 603
 Screws stainless steel M8583, 585, 594
 SDL 150, for 3-circuit391
 SDL 70, for 3-circuit391
 SDL DISPLAY190
 SDL PRO 150, for 3-circuit391
 SDL PRO 70, for 3-circuit390
 SEDO 14 wall light269
 SEDO 21 wall light269
 SEDO LED 21 wall light269
 SENSER LED RECESSED PANEL516
 SENSER LED RECESSED PANEL165, 291
 SENSER LED
 SURFACE-MOUNTED PANEL164, 290
 SFL colour slide for SFL PAR392
 SFL PAR20 G, for 3-circuit392
 SFL PAR36 ES111, for 3-circuit392
 SFL PAR56 T 150 LONG HV G12,
 for 3-circuit393
 SFL PAR56 T 70 LONG HV G12,
 for 3-circuit393
 SFL PAR56 TS 150 LONG HV Rx7s,
 for 3-circuit393
 SFL PAR56 TS 70 LONG HV Rx7s,
 for 3-circuit393
 SHELL HIT-DE wall light245
 SHELL HIT-DE wall light245
 SHELL WL-1 TC-DE wall light245
 SHORTBOX feed-in for EASYTEC® II431
 SHORTBOX feed-in for EASYTEC® II431
 SHORTBOX TRANSFORMER
 for LINUX LIGHT®439
 SHORTBOX TRANSFORMER
 for LINUX LIGHT®439
 Shutters for SDL 70/150391

Shutters for SFL PAR20392
 Shutters for SFL PAR36392
 Shutters for SFL PAR56393
 SIENA lamp head for EASYTEC® II432
 SIGHT 24 wall and ceiling light271, 363
 SIGHT 54 TRACK, for 3-circuit405
 SIGHT 54 wall and ceiling light271, 363
 SITRA 360 SL outdoor light601
 SITRA 360 SL SPIKE607
 SITRA 360 SPIKE615
 SITRA 360 WL wall light692, 706
 SITRA 6x1W LED wall light643
 SITRA CEILING ceiling light703
 SITRA CUBE wall light667
 SITRA EARTH SPIKE615
 SITRA WALL UP-DOWN wall light643
 SITRA WALL wall light643
 SKALUX ceiling recessed light517
 SKALUX CL-1 ceiling light301
 SKALUX COMB ceiling recessed light517
 SKALUX COMB CL-1 ceiling light301
 SKELETO display light190
 SLEEK SPOT G12, for 3-circuit389
 SLOTBOX 40 floor stand559
 SLOTBOX 70 floor stand559
 SLOTS 300, floor stand594
 SLOTS 45 floor stand594
 SLOTS 65 floor stand594
 SLOTS WALL wall light665
 SLV CONTROL
 3-channel radio receiver module791
 internal control station790
 IP 56 outdoor housing
 for 3-channel receiver module791
 radio brightness sensor791
 radio dimmer module
 for socket installation793
 radio magnet switch791
 radio motion sensor indoor790
 radio motion sensor outdoor790
 radio receiver for controlling blinds793
 radio recessed multidimmer
 with 6 memory addresses792
 radio recessed switch
 with 6 memory addresses792
 radio remote control 16-channel790
 radio socket outdoor792
 radio socket switch792
 radio switch module
 for socket installation793
 radio switch module for socket
 installation with neutral conductor793
 radio switch module
 for switching flush sockets793
 radio wall switch double791
 radio wall switch single790
 signal amplifier793
 SOBERBIA LED pendant081
 SOLASTO, inground fitting730
 Solo 90° lamp head for GLU-TRAX®447
 SOPRANA BOW floor stand041
 SOPRANA CL-1 ceiling light279
 SOPRANA CONE PD-1 pendant051
 SOPRANA CONE PD-2 pendant049
 SOPRANA OVAL SL-1 floor stand045
 SOPRANA OVAL TL-1 table lamp027
 SOPRANA OVAL WL-1 wall light175
 SOPRANA PD-1 pendant073
 SOPRANA PD-2 pendant077
 SOPRANA PD-3 pendant051
 SOPRANA PD-4 pendant073
 SOPRANA PD-5 pendant077
 SOPRANA pendant, for 1-circuit429
 SOPRANA SL-1 floor stand043
 SOPRANA SL-2 floor stand045
 SOPRANA SOLID TL-1 table lamp023
 SOPRANA SOLID PD-1 pendant085
 SOPRANA SOLID PD-2 pendant085
 SOPRANA SOLID PD-3, pendant087
 SOPRANA SOLID PD-4, pendant087
 SOPRANA SOLID TL-2 table lamp023
 SOPRANA SOLID WL-1 wall light241
 SOPRANA SOLID WL-2, wall light241
 SOPRANA TL-1 table lamp025
 SOPRANA TL-2 table lamp025
 SOPRANA TRIPOD floor stand041
 SOPRANA WL-1 wall light175
 SOPRANA WL-2 wall light171

SPOODI, flood light617
 SPOT 79 230V wall and ceiling light335
 Springs for PROFILE 2609760
 SQUARE C wall and ceiling light705
 SQUARE DICE 2 wall and ceiling light344
 SQUARE DICE wall and ceiling light344
 SQUARE MR16 downlight490
 SQUARE POLE 30 floor stand587
 SQUARE POLE 60 floor stand587
 SQUARE POLE 90 floor stand587
 SQUARE TURN G9 wall light664
 SQUARE WALL wall light239
 SQUARE WL wall light635
 Stabilizer corner connector long
 for 1-circuit HV track409, 411
 Stabilizer long connector long
 for 1-circuit HV track411
 Stabilizer X-connector long
 for 1-circuit HV track411
 Steel rope suspension, steel819
 Steel rope, 0, 75mm with PVC jacket819
 Stickers801
 STIX wall light181
 Stopper for steel rope 0, 75mm819
 STRATOS lamp head
 for LINUX LIGHT®440
 Structure glass for AIXLIGHT® PRO
 installation frame481
 SUN CEILING ceiling light281
 SUN pendant071
 SUPROS CL, ceiling light349
 SUPROS DL, ceiling recessed light509
 SUPROS MOVE, ceiling recessed light509
 SUPROS PD pendant093
 SUPROS TRACK 3000 spot,
 for 3-circuit387
 SURA rope light451
 Suspension set
 for 1-10V MEDO LED135, 356
 Suspension set for ALU PROFILE
 and ALU RECESSED PROFILE762
 Suspension set for LED Panel127
 Suspension set
 for TEC KARDA 2/4/6 QRB211, 319
 SXL HIT SPOT 400W626
 SXL HIT-DE SPOT 150W626
 SXL HIT-DE SPOT 70W626
 SYROS fitting for WAVE445
 SYROS lamp head for LINUX LIGHT®441
 SYROS lamp head for LINUX LIGHT®441
 SYROS rope light450
 System rod for WAVE444

T

T-connector for 1-circuit HV track,
 surface-mounted411
 T16 GRILL UNI,
 wall and ceiling light169, 357
 T5 BAR recessed light521
 T5 element
 for AIXLIGHT® PENDANT SYSTEM106
 T5 GRILL pendant129
 T5 GRILL QRB pendant129
 TANI wall light223
 TC INDI 255 ceiling light359
 TC RASTER 218 ceiling light359
 TC RASTER 336 ceiling light359
 TCI LED POWER SUPPLY UNIT807
 TEC 1 QRB spot, for 3-circuit395
 TEC 1 QRB111 spot for 1-circuit414
 TEC 2 QRB spot, for 3-circuit395
 TEC 2 QRB111 spot, for 1-circuit414
 TEC 4 QRB spot, for 3-circuit395
 TEC KARDA 2 wall and ceiling light211, 319
 TEC KARDA 4 wall and ceiling light319
 TEC KARDA 6 wall and ceiling light319
 TELESCOPE rope light450
 TENDA LED wall light649
 TENORA CL-1 ceiling light279
 TENORA CL-2 ceiling light276
 TENORA FL-1 floor stand043
 TENORA PD-1 pendant074
 TENORA TL-1 table lamp026
 TENORA WL-1 wall light173
 TENORA WL-2 wall light173
 TERANG 2 wall and ceiling light678, 698

TERANG 2 XL
 wall and ceiling light679, 698
 TERANG wall and ceiling light678, 698
 Textile cable818
 THEO CEILING OUT ceiling light703
 THEO UP/DOWN OUT wall light661
 THEO UP/DOWN wall light237
 THEO WALL OUT wall light661
 THEOS 101 E27 wall light669
 THEOS 102 E27 wall light669
 TIGLA ROUND downlight308
 TIGLA SQUARE downlight308
 TONGA 4 pendant for EASYTEC® II437
 TONGA IV pendant065
 TONGA IV pendant for LINUX LIGHT®443
 TONGA V pendant, for 1-circuit429
 Track for LED PENLIGHT PRO 230V785
 Track for LINUX LIGHT®439
 TRAIL-LITE recessed light723
 TRANSFORMER 105VA444, 813
 TRANSFORMER 210VA444, 813
 TRANSFORMER BOX IP67816
 TRAPECCO WALL DOWN673
 TRAPECCO WALL UP673
 TRAPECCO, floor stand561
 TRIADEM pendant048
 TRILEDO ROUND CL
 surface-mounted downlight309
 TRILEDO SQUARE CL
 surface-mounted downlight309
 TRISTAN T8 ceiling light365
 TRISTAN T8 ceiling light365
 TRITON 3 LED downlight503
 TRITON 3 LED downlight503
 TRITON MINI LED HORN downlight523
 TRUKKO, wall light257
 TRUKKO, wall mirror264
 TRUST 30 floor stand593
 TRUST 60 floor stand593
 TRUST GRID593, 632
 TRUST WALL wall light632
 TUBE ceiling light299
 Tube kit for NEPRO DISPLAY clamp191
 Turbo glue 100
 for LED PENLIGHT PRO 230V785
 TURNO GU10 downlight491

U

UFO BEAM649
 Universal surface-mounted frame
 for LED panel, long127, 361
 Universal surface-mounted frame
 for LED panel, square361, 519
 UTIX LED downlight set524

V

VANO DISPLAY outdoor light629
 VANO TC outdoor light629
 VANO WING outdoor light628
 VANO WING PL outdoor light628
 VAP 100 floor stand585
 VAP 40 floor stand585
 VAP 70 floor stand585
 VAP LED 30, floor stand589
 VAP LED 60, floor stand589
 VAP SLIM 30 floor stand589
 VAP SLIM 60 floor stand589
 VAP SLIM 90 floor stand589
 VAYNISSA, wall and ceiling light197
 VINCELLI DISPLAY wall light193
 VINCELLI PD pendant121
 VINCELLI TL table lamp029
 VINCELLI WL wall light193
 VISSARDO, table vanity mirror264
 VISSARDO, wall vanity mirror264

W

Wall and ceiling holder for AIXLIGHT® LONG
 and SQUARE MR16/ GU10122, 123, 125
 Wall holder for AIXLIGHT® LONG
 and SQUARE MR16123
 Wall holder for LINUX LIGHT®439
 Wall holder for LV rope system449
 Wall holder for VANO TC
 and VANO DISPLAY629

Wall holder for VANO TC and VANO DISPLAY	629
Wall holder for VANO TC and VANO DISPLAY	629
Wall holder for VANO WING and VANO WING PL	628
WALLYX GU10 wall light	677
WAVE angle 90°	444
WAVE angle plug	444
WAVE connection plug	444
WAVE PENDANT pendant	063
WAVE PENDANT pendant, for 1-circuit	427
WAVE WALL wall light	227
WETSY LED DISK 300 recessed light	726
WETSY outdoor light	726
WETSY POWER LED recessed light	726
WL 103, wall light	155
WL 104, wall and ceiling light	155, 281
WL 105, wall light	261
WL 106, wall light	261
WL 149 G9, wall light	221
WL 149 G9, wall light	221
WL 149 R7s, wall light	221
WL 172 GX53, wall light	656
WORK LIGHT FLOOR floor stand	033
WORK LIGHT PENDANT pendant	109
WORKLIGHT LED SL-1, floor stand	035
WORKLIGHT LED SL-2, floor stand	035
WORKLIGHT WAVE wall light	271

X

X-connector for 1-circuit HV track, surface-mounted	411
XERXES CHROME ceiling light	167, 297

Y

YANTI lamp head for LINUX LIGHT®	440
YOKI ES111 lamp head for EASYTEC® II	433
YOKI ES111 spot for EASYTEC® II	433
YUDI downlight	527

Z

Z 211 wall light	257
ZENIT LED wall and ceiling light	161

L147550335	L149150211,319	L151600249	L152232397	L153404383	L153941379
L147551335	L149252297	L151601249	L152240397	L153410383	L153944379
L147556335	L149262143	L151610249	L152241397	L153411383	L153950379
L147559335	L149271305	L151611249	L152242397	L153414383	L153951379
L147562223	L149274305	L151635163	L152250397	L153420385	L153954379
L147566223	L149276297	L151674223	L152251397	L153421385	L153960379
L147581317	L149286143	L151691163	L152254397	L153424385	L153961379
L147582317	L149291237	L151695163	L152320401	L153430385	L153964379
L147583317	L149294237	L151700229	L152321401	L153431385	L153970379
L147591317	L149375143	L151701229	L152324401	L153434385	L153971379
L147592317	L149380061	L151703229	L152420374	L153490379	L153974379
L147593317	L149381053	L151710229	L152421374	L153491379	L153980379
L147600217,331	L149385053	L151711229	L152424374	L153494379	L153981379
L147601217,331	L149386053	L151713229	L152430374	L153502375	L153984379
L147610217,331	L149387053	L151722229	L152431374	L153511405	L153990379
L147611217,331	L149388053	L151751649	L152434374	L153514405	L153991379
L147620217,331	L149452177	L151757649	L152440399	L153560399	L153994379
L147621217,331	L149471221	L151761269305,349,374,412		L153561399		
L147630217,331	L149472221	L151762269	L152441399	L153564399		
L147631217,331	L149482261	L151771269305,349,374,412		L153580377	L154000	
L147640216,330	L149492261	L151772269	L152444399	L153581377	L154202123
L147641216,330	L149501221	L151791269305,349,374,412		L153584377	L154212123
L147650216,330	L149502221	L151796269	L152460374	L153621390	L154242122
L147651216,330	L149701197	L151800254	L152461374	L153624390	L154252122
L147660039	L149702197	L151801254	L152464374	L153631391	L154302123
L147661039	L149752264	L151803254	L152470374	L153634391	L154312122,123,125
L147670039	L149762257	L151804254	L152471374	L153640389	L154352125
L147671039	L149772257	L151810307	L152474374	L153641389	L154362125
L147706211,321	L149782264	L151811307	L152540373	L153644389	L154372125
L147716211,321	L149792264	L151813307	L152541373	L153650389	L154512395
L147801197,342			L151814307	L152544373	L153651389	L154602475
L147811197,342			L151820343	L152550373	L153654389	L154612475
L147820227	L150000		L151821343	L152551373	L153660389	L154622475
L147821227	L150331245	L151823343	L152554373	L153661389	L154632475
L147823227	L150471245	L151824343	L152580375	L153664389	L154704106
L147826227	L150551391	L151830343	L152581375	L153670389	L154714106
L147830063	L150552391	L151831343	L152600377	L153671389	L154724107
L147831063	L150561391	L151833343	L152601377	L153672389	L154734107
L147833063	L150562391	L151834343	L152604377	L153674389	L154744107
L147836063	L150571391	L151840199,239,254,	L152610377	L153681389	L154754107
		L150572391307,340,341,343		L152611377	L153682389	L154774107
		L150631245	L151850053	L152614377	L153684389	L154784107
L148000				L151851053	L152620387	L153730389	L154794107
L148001293	L151000		L151853053	L152621387	L153731389	L154804106
L148002293	L151011401	L151854053	L152740373	L153734389	L154814106
L148004303	L151017401	L151884161	L152741373	L153741389	L154824107
L148010235	L151017401	L151894161	L152744373	L153742389	L154900099
L148011223	L151040067,207,333	L151901253	L152750373	L153743389	L154901099
L148012222	L151041067,207,333	L151910253	L152751373	L153746389	L154910099
L148013241	L151049067,183,185,	L151912206,340	L152754373	L153800381	L154911099
L148015235187,207,333		L151914253	L152760373	L153801381	L154920099
L148016251	L151050187,189	L151922206,341	L152761373	L153804381	L154921099
L148017243	L151051187,189	L151950531	L152764373	L153810381	L154930099
L148018234	L151132344	L151951531	L152770373	L153811381	L154931099
L148019247	L151142344	L151952531	L152771373	L153814381	L154940219
L148021498,539	L151171206,345	L151960531	L152774373	L153830383	L154941219
L148022498,539	L151174206,345	L151961531	L152780373	L153831383		
L148040069	L151181206,345	L151962531	L152781373	L153834383		
L148041063	L151184206,345	L151972529	L152784373	L153840383	L155000	
L148042061	L151271225	L151973529	L152790373	L153841383	L155001270
L148051303	L151275225			L152791373	L153844383	L155002270
L148052303	L151282261	L152000		L152794373	L153850385	L155012113
L148053303	L151311225	L152000239	L152950399	L153851385	L155022113
L148060251	L151315225	L152001239	L152951399	L153854385	L155051113,270
L148500199,348	L151320230	L152004239	L152954399	L153860383	L155052113,270
L148501199,348	L151321230	L152003239	L152980387	L153861383	L155100178
L148504199,348	L151325230	L152004239	L152981387	L153864383	L155101178
L148510348	L151390239	L152010199,340	L152990387	L153870383	L155103178
L148511348	L151410225	L152011199,340	L152991387	L153871383	L155104178
L148514348	L151411225	L152013199,340			L153874383	L155105178
L148520348	L151416225	L152014199,340			L153880383	L155106178
L148521348	L151450225	L152020199,341	L153000		L153881383	L155114179
L148524348	L151451225	L152021199,341	L153002395	L153884383	L155172167,297
		L151456225	L152023199,341	L153012395	L153890383	L155180167,287
		L151471227	L152024199,341	L153022395	L153891383	L155185157,287
L149000		L151476227	L152062528	L153102401	L153894383	L155190167,287
L149031209	L151501231	L152070530	L153112403	L153900379	L155206268
L149042209,333	L151504231	L152072530	L153130403	L153901379	L155216268
L149060207,333	L151511305	L152079530	L153131403	L153904379	L155236155,295
L149061207,333	L151514305	L152081237	L153140403	L153910379	L155240155
L149062207,333	L151521345	L152082237	L153141403	L153911379	L155250155,281
L149065207,333	L151524345	L152089237	L153312392	L153914379	L155260221
L149070207,333	L151531345	L152101305	L153322392	L153920379	L155272221
L149071207,333	L151534345	L152111349	L153332393	L153921379	L155272295
L149072207,333	L151542259	L152200400	L153342393	L153924379	L155280073
L149075207,333	L151552259	L152201400	L153352393	L153930379	L155283073
L149142211,319	L151561239	L152204400	L153362393	L153931379	L155290073
L149144319	L151564239	L152230397	L153400383	L153934379	L155291073
L149146319	L151591163	L152231397	L153401383	L153940379	L155292073

LI155293073	LI155981801	LI157634119	LI160000		LI162813516	LI185000	
LI155300076	LI155982801	LI157641119	LI160124521	LI162903164,290	LI185002431
LI155301076	LI155983801	LI157644119	LI160134531	LI162913164,290	LI185012431
LI155310171	LI155984801	LI157821121	LI160202271,363	LI162923164,290	LI185020431
LI155311171	LI155985801	LI157831121	LI160206271,363	LI162933164,290	LI185032431
LI155340171	LI155986801	LI157901035	LI160212271,363	LI162943164,290	LI185042431
LI155341171	LI155987801	LI157905035	LI160216271,363	LI162953164,290	LI185062431
LI155352025	LI155988801	LI157911035	LI160291515	LI162963165,291	LI185092432
LI155353025	LI155989801	LI157915035	LI160294515	LI162973165,291	LI185142431
LI155362045	LI155990801			LI160352515	LI162983165,291	LI185172431
LI155363045	LI155991801			LI160354515	LI162993165,291	LI185294431
LI155372279	LI155992801	LI158000		LI160421504			LI185302431
LI155373279	LI155993801	LI158602127,361,519	LI160431504			LI185440435
LI155380051	LI155994801	LI158603127,361,519	LI160441505	LI163000		LI185450435
LI155382051	LI155995801	LI158604127,361,519	LI160451505	LI163003165,291	LI185521437
LI155383051	LI155996801	LI158612127,361,519	LI160461505	LI163013165,291	LI185580435
LI155400079	LI155997801	LI158613127,361,519	LI160471505			LI185582435
LI155402079	LI155998801	LI158614127,361,519	LI160481505	LI165000		LI185590436
LI155412025	LI155999801	LI158622139	LI160491505	LI165100095	LI185592436
LI155422043			LI158623139	LI160541501	LI165110097	LI185622433
LI155432077			LI158624139	LI160544501	LI165140097	LI185632433
LI155462077	LI156000		LI158632139	LI160551501	LI165160095,097	LI185692435
LI155463077	LI156000276	LI158633139	LI160554501	LI165180097	LI185742432
LI155470091	LI156001276	LI158634139	LI160631501	LI165190097		
LI155471091	LI156010173	LI158662518	LI160634501	LI165204095	LI186000	
LI155475091	LI156011173	LI158663518	LI160761365	LI165221096	LI186015446
LI155479091	LI156020173	LI158664518	LI160764365	LI165222096	LI186020446
LI155500083	LI156021173	LI158703518	LI160771359	LI165320096	LI186042447
LI155501083	LI156030043	LI158704518	LI160773363	LI165340095	LI186272447
LI155510083	LI156031043	LI158713518	LI160774363	LI165350094	LI186302449
LI155511083	LI156040026	LI158714518	LI160781359	LI165356094	LI186312449
LI155520083	LI156041026	LI158722127,361	LI160791359	LI165358094	LI186332449
LI155521083	LI156050279	LI158723127,361	LI160802110	LI165359094	LI186342449
LI155530083	LI156051279	LI158724127,361	LI160812110	LI165390144	LI186352449
LI155531083	LI156060074	LI158732127,361	LI160822110	LI165400145	LI186362449
LI155542021	LI156061074	LI158733127,361	LI160831115	LI165410145	LI186462451
LI155552277	LI156227121	LI158734127,361	LI160832115	LI165420145	LI186492450
LI155562075	LI156237029	LI158762361,519	LI160841365	LI165451081	LI186500446
LI155570075,277	LI156247193	LI158772361,519	LI160861365	LI165500089	LI186512446
LI155580021,075,277	LI156257193	LI158782127,361	LI160864365	LI165501089	LI186522446
LI155582021,075,277	LI156301058	LI158784127,361	LI160874116	LI165600097	LI186530446
LI155583021,075,277	LI156311158	LI158791127			LI165610096	LI186540446
LI155584021,075,277	LI156321039	LI158799127			LI165611096	LI186562447
LI155585021,075,277	LI156400510			LI161000		LI166042447	LI186642449
LI155586021,075,277	LI156401510			LI161271497	LI167032813	LI186762447
LI155587021,075,277	LI156410510	LI159000		LI161281497	LI167039813	LI186772446
LI155589021,075,277	LI156411510	LI159000219	LI161291497			LI186952446
LI155620175	LI156420209,351	LI159001219	LI161301497				
LI155621175	LI156421209,351	LI159004219	LI161431299				
LI155643171	LI156430351	LI159010219	LI161434299				
LI155650079	LI156431351	LI159011219	LI161441299	LI170000		LI186762447
LI155651025	LI156440351	LI159014219	LI161461299	LI170401191	LI186772446
LI155652044	LI156441351	LI159020100	LI161464299	LI170402191	LI186952446
LI155670177	LI156812392	LI159021100			LI170414190		
LI155673177	LI156822392	LI159024100			LI170422188		
LI155681177	LI156832393	LI159030100	LI162000		LI170424188		
LI155700023	LI156914392	LI159031100	LI162021511				
LI155701023	LI156915392	LI159034100	LI162024511				
LI155710085	LI156916392	LI159040100	LI162031511				
LI155711085	LI156917392	LI159041100	LI162034511	LI181000		LI184000431
LI155712087	LI156919392	LI159044100	LI162036511	LI181080450	LI184002431
LI155713087			LI159050100	LI162151511	LI181180451	LI184012431
LI155720041	LI157000		LI159051100	LI162154511	LI181212450	LI184022431
LI155723041	LI157004037	LI159054100	LI162171511	LI181232451	LI184032431
LI155730041	LI157052271	LI159060101	LI162173511	LI181532449	LI184042431
LI155733041	LI157059169,357	LI159061101	LI162176511			LI184062431
LI155750241	LI157091169,357	LI159064101	LI162481515	LI184000		LI184072433
LI155751241	LI157092169,357	LI159070101	LI162484515	LI184000431	LI184092432
LI155760051	LI157101129	LI159071101	LI162491301	LI184142431	LI184172431
LI155761051	LI157102129	LI159074101	LI162494301	LI184172431	LI184292431
LI155764051	LI157112129	LI159080101	LI162601517	LI184302431	LI184332431
LI155770049	LI157152033	LI159081101	LI162604517	LI184402431	LI184452435
LI155840027	LI157154033	LI159084101	LI162611517	LI184452435	LI184521437
LI155841027	LI157192267	LI159090102	LI162614517	LI184534437	LI184534437
LI155850045	LI157202267	LI159091102	LI162631301	LI184624433	LI184634433
LI155851045	LI157284109	LI159094102	LI162634301				
LI155860175	LI157334129	LI159100103	LI162641301				
LI155861175	LI157371169,357	LI159101103	LI162644301				
LI155870048	LI157381169,357	LI159104103	LI162703516				
LI155871048	LI157384169,357	LI159110102	LI162713516				
LI155900083	LI157414265	LI159111102	LI162723516				
LI155901083	LI157424265	LI159114102	LI162733516				
LI155910083	LI157472267	LI159120103	LI162743516				
LI155911083	LI157494115	LI159121103	LI162753516				
LI155920083	LI157514109	LI159124103	LI162763516				
LI155921083	LI157524109	LI159200100	LI162773516				
LI155930083	LI157534365	LI159201100	LI162783516				
LI155931083	LI157584271	LI159202100	LI162793516				
LI155980801	LI157631119			LI162803516				

LJ213534746	LJ213950770	LJ227922591,593	LJ229021567	LJ229571659	LJ230202712
LJ213541747	LJ213951770	LJ227932593	LJ229022567	LJ229574659	LJ230211712
LJ213544747	LJ213954770	LJ227942632	LJ229044626	LJ229575659	LJ230212712
LJ213551747	LJ213961770	LJ227952593,632	LJ229050585	LJ229581703	LJ230221712
LJ213554747	LJ213962770	LJ227962593	LJ229054585	LJ229584703	LJ230222712
LJ213571746,747	LJ213970770	LJ227975579	LJ229057585	LJ229585703	LJ230231713
LJ213574746,747	LJ213971770	LJ227985579	LJ229059585	LJ229601660	LJ230232713
LJ213581752	LJ213974770			LJ229062711	LJ229604660	LJ230301712
LJ213582752					LJ229071680,695	LJ229611669	LJ230302712
LJ213591753					LJ229072680,695	LJ229616669	LJ230311712
LJ213592753					LJ229075680,695	LJ229618669	LJ230312712
LJ213594753	LJ214000		LJ228000		LJ229081681,695	LJ229621669	LJ230332643
LJ213595753	LJ214001751	LJ228050549	LJ229084681,695	LJ229626669	LJ230354643
LJ213599753	LJ214004751	LJ228052549	LJ229085681,695	LJ229628669	LJ230355643
LJ213610762	LJ214010751	LJ228210732	LJ229087681,695	LJ229641649	LJ230364643
LJ213611762	LJ214011751	LJ228214732	LJ229090619	LJ229642649	LJ230365643
LJ213614762	LJ214014751	LJ228218732	LJ229100618	LJ229647649	LJ230374615
LJ213620762	LJ214040751	LJ228240739	LJ229110709	LJ229652649	LJ230375615
LJ213621762	LJ214041751	LJ228244739	LJ229121713	LJ229654663	LJ230401683,697
LJ213624762	LJ214044751	LJ228301729	LJ229122713	LJ229665663	LJ230404683,697
LJ213630762	LJ214050751	LJ228304729	LJ229132633	LJ229667663	LJ230405683,697
LJ213631762	LJ214051751	LJ228331723	LJ229142593	LJ229684663	LJ230415709
LJ213634762	LJ214054751	LJ228332723	LJ229152610	LJ229685663	LJ230424713
LJ213641762	LJ214060751	LJ228337723	LJ229162591	LJ229687663	LJ230434555
LJ213642762	LJ214064751	LJ228341723	LJ229172591	LJ229701711	LJ230435555
LJ213643762	LJ214066751	LJ228342723	LJ229182633	LJ229702711	LJ230444685
LJ213650762	LJ214068751	LJ228360729	LJ229200736	LJ229722711	LJ230445685
LJ213651762			LJ228365729	LJ229204736	LJ229730619	LJ230447685
LJ213654762			LJ228370735	LJ229210736	LJ229740613	LJ230454583
LJ213660756	LJ220000		LJ228401725	LJ229214736	LJ229746639	LJ230455583
LJ213661756	LJ220000446	LJ228402725	LJ229230735	LJ229756305,702	LJ230464583
LJ213664756			LJ228411725	LJ229234735	LJ229766255,639	LJ230465583
LJ213674756			LJ228412725	LJ229250709	LJ229776255,639	LJ230525618,692,706
LJ213700760	LJ227000		LJ228420731	LJ229260816	LJ229786639	LJ230545611
LJ213701760	LJ227000818	LJ228424731	LJ229261816	LJ229836563	LJ230595627
LJ213704760	LJ227001818	LJ228430733	LJ229262817	LJ229840557,563	LJ230630618,627
LJ213710761	LJ227002818	LJ228434733	LJ229268817	LJ229841557,563	LJ230641687
LJ213711761	LJ227015663	LJ228501703	LJ229269817	LJ229856563	LJ230644687
LJ213714761	LJ227020663	LJ228505703	LJ229270739	LJ229890671	LJ230645687
LJ213720761	LJ227032671	LJ228511647	LJ229274739	LJ229894671	LJ230655687
LJ213721761	LJ227050671	LJ228515647	LJ229294738	LJ229904656	LJ230657687
LJ213724761	LJ227051671	LJ228521647	LJ229311725	LJ229905656	LJ230674664
LJ213741760	LJ227054671	LJ228525647	LJ229312725	LJ229912680,701	LJ230706635
LJ213742760	LJ227064665	LJ228531689	LJ229320733	LJ229921678,698	LJ230716705
LJ213743760	LJ227065665	LJ228535689	LJ229324733	LJ229924678,698	LJ230720705
LJ213751760	LJ227090735	LJ228545563	LJ229330731	LJ229925678,698	LJ230726701
LJ213752760	LJ227092735	LJ228712599,600,603	LJ229334731	LJ229927678,698	LJ230736636
LJ213753760	LJ227132657	LJ228722599,600,603	LJ229340731	LJ229931678,698	LJ230746636
LJ213761760	LJ227140813	LJ228724817	LJ229344731	LJ229934678,698	LJ230791242,653
LJ213762760	LJ227150813	LJ228725817	LJ229360725	LJ229935678,698	LJ230794242,653
LJ213763760	LJ227160813	LJ228726817	LJ229374733	LJ229937678,698	LJ230802617,692,706
LJ213770760	LJ227174684	LJ228730817	LJ229381738	LJ229941679,698	LJ230812612
LJ213771760	LJ227176684	LJ228752600,603	LJ229383738	LJ229944679,698	LJ230813612
LJ213774760	LJ227191677	LJ228753583,585,594	LJ229392628	LJ229945679,698	LJ230862654
LJ213780760	LJ227194677	LJ228754559,	LJ229394628	LJ229947679,698	LJ230872654
LJ213781760	LJ227195677	LJ228771641	LJ229395628	LJ229981700	LJ230881167,289,683
LJ213784760	LJ227198677	LJ228774641	LJ229400629	LJ229984700	LJ230884167,289,683
LJ213790760	LJ227211551	LJ228775641	LJ229402629	LJ229991659	LJ230891289,697
LJ213791760	LJ227219550	LJ228776641	LJ229404629	LJ229994659	LJ230894289,697
LJ213794760	LJ227220550	LJ228777641	LJ229405629			LJ230900730
LJ213799760	LJ227221550	LJ228812689	LJ229406629			LJ230904730
LJ213800768	LJ227232641	LJ228815689	LJ229410571	LJ230000		LJ230910732
LJ213801768	LJ227252657	LJ228842688	LJ229411571	LJ230030671	LJ230914732
LJ213804768	LJ227262657	LJ228845688	LJ229420565	LJ230031671		
LJ213810768	LJ227290649	LJ228892599	LJ229421565	LJ230034671	LJ231000	
LJ213811768	LJ227361551	LJ228912599	LJ229422565,569,577	LJ230044686	LJ231010160,655
LJ213814768	LJ227410613	LJ228915599	LJ229423569	LJ230045686	LJ231012160,655
LJ213821768,773	LJ227418613	LJ228922599	LJ229430569	LJ230047686	LJ231015160,655
LJ213822768,773	LJ227419613	LJ228925599	LJ229431569	LJ230054627	LJ231022615
LJ213830768	LJ227421726	LJ228932599	LJ229432569	LJ230060589,597,601	LJ231025615
LJ213831768	LJ227422726	LJ228935599	LJ229461621	LJ230061589,597	LJ231035615
LJ213834768	LJ227431726	LJ228942599	LJ229462621	LJ230063589	LJ231045691
LJ213840768	LJ227432726	LJ228945599	LJ229481621	LJ230066589	LJ231055691
LJ213841768	LJ227461723	LJ228948599	LJ229482621	LJ230069589	LJ231092627
LJ213844768	LJ227462723	LJ228951600	LJ229521661	LJ230084686	LJ231101614,623
LJ213849768	LJ227471723	LJ228955600	LJ229524661	LJ230085686	LJ231102614,623
LJ213861773	LJ227472723	LJ228958600	LJ229525661	LJ230087686	LJ231111622
LJ213862773	LJ227485726	LJ228959600	LJ229531661	LJ230090569	LJ231112622
LJ213874773	LJ227490726	LJ228961545	LJ229532661	LJ230100737	LJ231113622
LJ213901748	LJ227495726	LJ228965545	LJ229533661	LJ230110737	LJ231119622
LJ213904748	LJ227500619	LJ228971547	LJ229535661	LJ230131713	LJ231121623
LJ213911748	LJ227600727	LJ228975547	LJ229536661	LJ230132713	LJ231122623
LJ213914748	LJ227604727	LJ228995547	LJ229541659	LJ230160727	LJ231151624
LJ213931748	LJ227680730			LJ229544659	LJ230164727	LJ231152624
LJ213934748	LJ227684730	LJ229000		LJ229551703	LJ230170726	LJ231161624
LJ213939748	LJ227845585	LJ229000626	LJ229554703	LJ230174726	LJ231162624
LJ213940770	LJ227874585	LJ229001626	LJ229555703	LJ230182712	LJ231173624
LJ213941770	LJ227881647	LJ229002626	LJ229561659	LJ230192712	LJ231175624
LJ213944770	LJ227885647	LJ229012626	LJ229564659	LJ230201712	LJ231195632
				LJ229020567	LJ229565659				

LI550382831	LI552273783	LI560192828	LI925000	
LI550392831	LI552275783	LI560201827	LI925190
LI550412776	LI552279783	LI560202827106,110,115,116	
LI550413774,775	LI552310621,783	LI560212834	LI925191106,115
LI550415774,776	LI552320621,783	LI560222832	LI925195529
LI550416774,775	LI552330621,783			LI925201528
LI550418782	LI552331621,783			LI925250529
LI550419782	LI552332621,783	LI570000			
LI550560774,775,776	LI552402774	LI570022827		
LI550570778	LI552403774	LI570023827	LI955000	
LI550672525	LI552405774	LI570041830	LI955000819
		LI552412774	LI570042830	LI955020819
LI551000		LI552413774	LI570043830	LI955030819
LI551242828	LI552415774	LI570044830	LI955135819
LI551243828	LI552422774	LI570052828	LI955137819
LI551244828	LI552423774	LI570053828		
LI551252829	LI552425774	LI570054828		
LI551253829	LI552432774	LI570062829	LI961000	
LI551254829	LI552433774	LI570063829	LI961031819
LI551263828	LI552435774	LI570064829	LI961034819
LI551273829	LI552442774	LI570074834	LI961036819
LI551283830	LI552443774	LI570076834	LI961037819
LI551301828	LI552445774	LI570084834	LI961062812
LI551302828	LI552451775	LI570086834	LI961250818
LI551311828	LI552453775	LI570502832	LI961270818
LI551312828	LI552460775	LI570512832	LI961271818
LI551321829	LI552461775	LI570522832	LI961274818
LI551322829	LI552462775	LI570532832	LI961275818
LI551331829	LI552472775	LI570542832	LI961276818
LI551332829	LI552473775	LI570552832		
LI551371834	LI552475775	LI570602831		
LI551372834	LI552482775	LI570612831		
LI551400831	LI552483775	LI570622831		
LI551402831	LI552485775	LI570632831		
LI551410831	LI552502776	LI570642831		
LI551412831	LI552503776	LI570652831		
LI551532833	LI552505776	LI570662832		
LI551543833	LI552512776	LI570672832		
LI551553833	LI552513776	LI570682832		
LI551602830	LI552515776	LI570692832		
LI551604830	LI552522776	LI570702832		
LI551612830	LI552523776	LI570712832		
LI551614830	LI552525776	LI570722832		
LI551624831	LI552532776	LI570732832		
LI551634831	LI552533776				
LI551642832	LI552535776	LI575000			
LI551644832	LI552542776	LI575360823		
LI551652832	LI552543776	LI575370823		
LI551654832	LI552545776	LI575520823		
LI551664832	LI552572777	LI575530823		
LI551674832	LI552573777	LI575535823		
LI551713827	LI552574777	LI575553823		
LI551751832	LI552582777	LI575540824		
LI551761832	LI552583777	LI575651824		
LI551792833	LI552584777	LI575652824		
LI551812832	LI552592777	LI575671824		
LI551822832	LI552593777	LI575672824		
LI551842833	LI552594777	LI575682823		
LI551862828	LI552602777				
LI551872829	LI552603777				
LI551882831	LI552604777	LI591000			
		LI552612777	LI591293837		
LI552000		LI552613777	LI591294837		
LI552100778	LI552614777	LI591295837		
LI552101778			LI591296837		
LI552102778	LI560000					
LI552103782	LI560031830	LI631000			
LI552107778	LI560032830	LI631432745		
LI552110778	LI560033830	LI631442745		
LI552111778	LI560034830	LI631451745		
LI552112778	LI560084829	LI631452745		
LI552113782	LI560122830	LI631453745		
LI552117778	LI560123830	LI631461745		
LI552120778	LI560124830	LI631462745		
LI552121778	LI560131830	LI631463745		
LI552122778	LI560132830	LI631470745		
LI552123782	LI560133830	LI631471745		
LI552127778	LI560134830	LI631472745		
LI552130778	LI560142830	LI631473745		
LI552131778	LI560143830	LI631474745		
LI552132778	LI560144830	LI631475745		
LI552140778	LI560150833	LI631482745		
LI552141778	LI560151833				
LI552142778	LI560160833				
LI552263783	LI560161833	LI900000			
LI552265783	LI560172828	LI900011622,623,624		
LI552269783	LI560173828				
		LI560182829				

PRODUCT FEATURES

230V~	230V~ 350 mA	Operation voltage <ul style="list-style-type: none"> High-voltage 230~ Integrated converter for 230V alternating voltage to 350mA constant direct current Low-voltage with voltage converter for high-voltage systems 230~/12~ Low-voltage 12~
230V~ 12V~	12V~	

	Energy efficiency class „This luminaire is compatible with bulbs of the energy classes ...“
--	---

	Energy efficiency class „This luminaire contains built-in LED lamps and has sockets for bulbs of the energy classes ...“

	Fittings with built-in LEDs „This luminaire contains built-in LED lamps. The lamps cannot be changed in the luminaire.“ [see EU directive 874/2012]
--	--

	Fittings with built-in LEDs „This luminaire contains built-in LED lamps. The lamps cannot be changed in the luminaire.“ [see EU directive 874/2012] <i>Note for the user:</i> The light source on this fittings must only be exchanged by the manufacturer or a service technician authorized by the manufacturer.
--	---

			Energy efficiency index of the ballast
--	--	--	--

		Dimmable with ... <ul style="list-style-type: none"> Trailing-edge dimmer Leading-edge dimmer 1-10V according accessories [e.g. for lamps with dimmable electronic ballast or low-voltage lamp]

		LED equipment Number and type of built-in LEDs.
35 pcs.	1 Module	

	Weight of the product in kg
--	---------------------------------------

		Adjustability: Fitting <ul style="list-style-type: none"> Rotation range Tilt range
--	--	--

		Adjustability: Lamp/part of fitting <ul style="list-style-type: none"> multi-directional multi-directional up to the indicated angle
--	--	---

			Beam angle symmetrical / focusable / asymmetrical
--	--	--	---

	Pendant cable length for pendants in m
--	--

	Maximum distance between wires for low-voltage wire systems in cm
--	---

	Average life span of a lamp or light source in hours
--	---

	We are happy to provide you with a light distribution curve for the respective product on request.
--	---

	Reflector lamps Multi mirror lamps [cool beam]: The main heat is emitted towards the back side of the reflector. Reduced thermal load at the light beam.
--	--

	Reflector lamps Direct beam lamps [no cool beam]: Thermal load at the light beam, therefore hardly any heat development on the back side of the reflector.
--	--

SPEZIFIC DATA – RECESSED FITTINGS

	Installation depth in cm [In case an installation pot is included, the dimensions refer to its size.]
--	---

			Installation cutout in cm Shape and size
--	--	--	--

90°C	Heat development on the inground fitting's surface
------	--

0,8 t	Weight capacity of the product up to the indicated value in tons. Measures are based on installation in concrete.
-------	--

APPLICATION / INSTALLATION

	Mounting space <ul style="list-style-type: none"> Wall [with respective accessories] Ceiling Floor Recessed
--	--

	<ul style="list-style-type: none"> Mounting surface on the wide side Mounting surface on the small side [vertical] Mounting surface on the small side [horizontal]
--	---

	<ul style="list-style-type: none"> Application exclusively indoors CRI<80: not suitable for indoor application Suitable for outdoors [IP classification]
--	---

>50W icon"/>	Mounting on normally inflammable surfaces <ul style="list-style-type: none"> not suitable for direct fixation not suitable if using a lamp >50W
--------------	---

	<ul style="list-style-type: none"> Allows mounting the device on materials with unknown inflammation behaviour.
--	--

	Lamp suitable for application in fittings ... <ul style="list-style-type: none"> with protective glass. without protective glass.
--	---

	Maximum conductor cross-section
--	--

	Cable diameter in mm
--	--------------------------------

	Through-wiring ... <ul style="list-style-type: none"> possible possible up to the indicated number of fittings
--	---

	Independent converter [Electric transformer for application outside of fittings as well.]
--	---

SAFETY-RELATED INFORMATION

	Safety class one / two / three
--	--

16A max.	Maximum current carrying capacity
----------	--

	Protection in case of failure for indicated temperature in °C
--	---

115°C	Thermal fuse with temperature indication in °C
-------	--

ta 40°	ta -25°~+40°	<ul style="list-style-type: none"> Allowed surrounding temperature in °C Allowed temperature range in °C
--------	--------------	--

	Lamp is equipped with UV protection
--	--

	Short-circuit-proof protection transformer
--	---

5 J	Impact resistance of the product up to the indicated value in Joule
-----	---

TEST MARKS

	Product VDE-tested
--	---------------------------

		Product TÜV design- / TÜV GS-tested
--	--	--

	Product ENEC-tested
--	----------------------------

	Product KEMA-tested [Netherlands]
--	--

	Product Nemco-tested [Norway]
--	--------------------------------------

	Product Semco-tested [Sweden]
--	--------------------------------------

SPECIAL SYMBOLS



Application of the fitting above 2,5 m when operating with halogen lamps;
this restriction does not apply in case of exclusive use of LED or energy-saving lamps.



Application of the fitting out of arm's reach only
[above 2,5 m]



Marks products newly introduced in the Big White 2016.



After priming the fitting can be painted over with wall paint.



Fitting is approved for the respectively indicated IP class.



Marks products that can be combined individually, according to taste and ambiance.

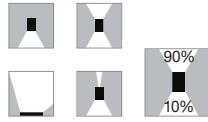

Light emission

- single
- double
- single with spot
- asymmetrical
- with percentaged distribution



Marks, in special cases, the on/off state of a fitting in the respective picture.



Marks fittings with motion sensor [MR technology / infrared].



Classification of product based on criteria such as exclusive design, high-quality material, technology, dimmability, LED.



Marks profiles that can be ordered with individual lengths and completely assembled according to the customer's wishes.

CUSTOMER INFORMATION

Information about heat development on lamp housing:

Halogen lamps and metal-halide discharge lamps (HID) have a high operating temperature and can cause heating of the respective lamp housing. The latter must therefore only be touched in cooled condition. Adjustable fittings or lamp heads which do not have an isolated adjustment handle or exceed the permissible housing temperature at the adjustment point during operation with maximum lamp wattage must be mounted out of arm's reach.

LED Retrofit lamps are available as low-temperature alternatives to most of our halogen lamps.

Luminous flux:

The total light quantity produced by a light source in indicated in Lumen (lm).

Luminosity:

Luminous flux released per solid angle. Indicated in Candela (cd).

Colour rendering index:

The colour rendering characteristics of a light source are described by the CRI. For light sources applied indoors a CRI of 80 or higher is compulsory. Light sources for outdoors require a CRI of at least 65.

Light colour:

The light colour of a light source is indicated in K (Kelvin).

Standard LED:

The classic LED model (3 mm or 5 mm LED). Those were originally developed for indication purposes, such as for instrument panels.

Standard SMD LED:

SMD means "Surface Mounted Device". It's a compact LED that has been soldered directly on the lead frame without any wire bonding. SMD is available in different sizes and well suited for lighting purposes.

PowerLED:

PowerLED is a high-performance LED with a wattage of 1W and more. It sets high requirements to the current constancy and should therefore only be operated with constant current sources. In case several LEDs are to be connected, they need to be connected in series. A parallel connection is inadmissible. Please also keep the order of installation in mind in order not to temporarily expose the LEDs to high currents that may damage them.

In general: First connect the secondary circuit [LEDs to driver], then close the primary circuit [LED driver to current source].

Chip On Board LED (COB LED); Flat Panel LED:

is an LED of extremely flat design. The COB LED's advantage is a good heat dissipation given the technical implementation with cooling surfaces, which enables a high light output as well as a long life span.

Stainless steel 304:

(1.4301) Good corrosion resistance for natural environmental media (water, municipal and rural atmosphere) with the absence of significant chlorine and salt concentration. However, 1.4301 is not suitable for applications where contact is made with sea water, salty water or a salty atmosphere. It is also not suitable for application in swimming pools and the like.

Stainless steel 316:

(1.4404) For natural environmental media (water, municipal and rural atmosphere) as well as industrial areas with moderate chlorine and salt concentration, for food and pharmaceutical industry and the rural food sector 1.4404 exhibits excellent corrosion resistance. It is not saltwater-proof.

Please note:

A large part of the products presented in this catalogue is protected by registered trade marks, design patents, utility models or patents. An offence against the patent rights or usage of text and layout without our permission will be legally pursued. All products of our portfolio are subject to strict quality inspection and fulfil the generally valid standards (CE).

The illustrations and data displayed in this catalogue are for illustration only and noncommittal in colour, shape, execution and technical data.

All weight and length specifications are indicated in kg or cm if not stated otherwise. Products marked with a ▼ are phase-out models.

The presentation of our lamps by realistic and exemplary application photos is possible due to the friendly compliancy and consent of the owners or designers of the surroundings shown in the foreground of the pictures. Again we would like to heartily thank everyone who contributed to the appearance and use of our photos with their consent.

CONNECTING COMPETENCE.



THE COMPANY

HEADQUARTERS

SCHRACK TECHNIK GMBH
Seybelgasse 13, A-1230 Vienna
PHONE +43(0)1/866 85-5900
FAX +43(0)1/866 85-98800
E-MAIL export@schrack.com

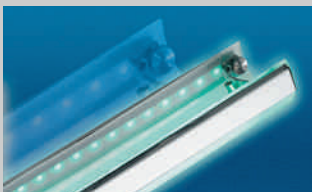

K-LICHT-E6



WWW.SCHRACK.COM