



**Schemi
commutatori
a camme
serie GX e GN**

**Circuit schemes
rotary cam
switches GX
and GN series**



**al servizio
del cliente**

**at the customer's
service**

Ufficio vendite

Tel 035 4282421

Fax 035 4282460

E-mail vendite@LovatoElectric.com

Sales Office

Tel +39 035 4282354

Fax +39 035 4282400

E-mail sales@LovatoElectric.com

Servizio Clienti Technical Support and Customer Care

Tel +39 035 4282422

Fax +39 035 4282295

E-mail service@LovatoElectric.com

Informazioni on line On line information

www.LovatoElectric.com

Sito internet ufficiale LOVATO Electric

Official LOVATO Electric website

Sede principale Head Office

Via Don E. Mazza, 12

24020 GORLE, BERGAMO (Italy)

Tel +39 035 4282111

Fax +39 035 4282200

E-mail info@LovatoElectric.com

I prodotti descritti in questo documento sono suscettibili in qualsiasi momento di evoluzioni o di modifiche. Le descrizioni ed i dati a catalogo e listino prezzi non possono pertanto avere nessun valore contrattuale. Si ricorda altresì che i prodotti stessi devono essere utilizzati da personale qualificato e comunque nel rispetto delle vigenti normative impiantistiche di installazione e ciò allo scopo di evitare danni a persone e cose.

The products illustrated in this publication are subject to be revised or improved at any moment. Catalogue descriptions, technical and operational data as well as other details herein specified do not have any contractual value so must be considered only as indication. The products must be installed and used by qualified personnel and in compliance with the regulations in force for electrical systems in order to avoid damages and safety hazards.

 **Lovato**
electric





GX...



GN...

Modalità di codifica / Order code structure	4
Tabella schemi speciali / Special circuit scheme form	5
Interruttori con angolo di rotazione 60° / On-Off switches with 60° switching	6
Interruttori con angolo di rotazione 90° / On-Off switches with 90° switching	7
Interruttori ad impulso con angolo di rotazione 30° con ritorno a "0" / Switches-spring return with 30° switching	8
Commutatori con angolo di rotazione 60° / Changeover switches with "0" - 60° switching	9
Deviatori con angolo di rotazione 90° / Changeover switches without "0" - 90° switching	10
Commutatori multivie senza "0" / Multi-step switches without "0" ..	11
Commutatori multivie con "0" / Multi-step switches with "0"	14
Commutatori a gruppi / Gang switches	21
Commutatori voltmetrici / Voltmeter switches	24
Commutatori amperometrici / Ammeter switches	25
Commutatori voltmetrici-amperometrici / Voltmeter-ammeter switches	27
Interruttori (con posizioni ad impulso) / Control switches (with spring return)	30
Invertitori di marcia / Motor reversing switches	32
Commutatori stella-triangolo / Star-delta switches	34
Commutatori di polarità (Dahlander) / Motor control switches (Dahlander)	37
Commutatori di polarità con inversione di marcia (Dahlander) / Motor control switches (Dahlander) - pole changing with reversing	38
Commutatori per motori (avvolgimenti separati) / Motor control switches (separate windings)	39
Commutatori di poli per motore a 3 velocità / Switches for 3-speed motor control	41
Invertitori di marcia con fase ausiliaria / Start and run switches ...	43
Dimensioni / Dimensions	44
Caratteristiche tecniche / Technical characteristics	46



Modalità di codifica

Order code structure

Modalità di codifica

Order code structure

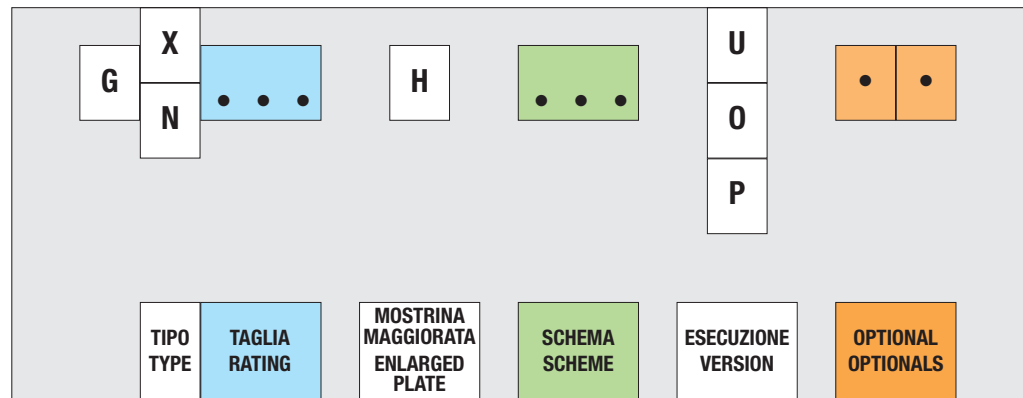

GX
 Protezione/Protection:
 Frontale/Front = IP65
 Contatti/Contacts = IP20

GN
 Protezione/Protection:
 Frontale/Front = IP40
 Contatti/Contacts = IP00

GX	GN
16A	12A
20A	20A
32A	25A
40A	32A
	40A
	63A
	125A

es./e.g. **U** = montaggio frontale
 front mounting
O = montaggio da fondo quadro
 rear mounting
P = in cassetta
 in enclosure

11	Montaggio frontale fissaggio centrale Ø22mm Front mount, with handle operation, for central 22mm fixing
12	A chiave montaggio frontale fissaggio centrale Ø22mm Front mount, with key operation, for central 22mm fixing
18	Fissaggio su guida DIN 35mm DIN rail mounting (IEC/EN 60715)
25	Maniglia lucchettabile giallo/rossa Red-yellow padlockable handle
48	Modulare fissaggio su guida DIN Modular service cover, 35mm DIN rail mounting
4V	Montaggio frontale fissaggio a 4 viti Front mount, with 4-screw fixing
51	Protezione frontale IP65 (solo GN) IP65 front protection, for GN only
65	Maniglia lucchettabile giallo/rossa Red-yellow padlockable handle
68	Bloccoporta Door coupling
78	Bloccoporta (escluso GN125) Door coupling (GN125 excluded)
79	Bloccoporta (solo GN125) Door coupling, for GN125 only
88	Maniglia lucchettabile giallo/rossa, bloccoporta Door coupling, with red-yellow padlockable handle
98	Maniglia lucchettabile giallo/rossa, bloccoporta (escluso GN125) Door coupling, with red-yellow padlockable handle (GN125 excluded)
99	Maniglia lucchettabile giallo/rossa, bloccoporta (solo GN125) Door coupling, with red-yellow padlockable handle, for GN125 only

Tabella schemi speciali

Special circuit scheme form

		1	4	5	8	9	12	13	16	17	20	21	24	25	28	29	32	33	36	37	40	41	44	45	48																					
		2	3	6	7	10	11	14	15	18	19	22	23	26	27	30	31	34	35	38	39	42	43	46	47																					
Simbologia mostrina Plate indication	pos.																																													
	7																																													
C	8																																													
	9																																													
	10																																													
D	11																																													
	12																																													
	1																																													
A	2																																													
	3																																													
	4																																													
B	5																																													
	6																																													
Mostrina frontale Front plate		<table style="width:100%; border-collapse: collapse;"> <tr> <td style="width:25%; text-align: center;">1</td> <td style="width:25%; text-align: center;">2</td> <td style="width:25%; text-align: center;">Contatti in sovrapposizione Overlapping contacts</td> <td style="width:25%; text-align: center;">Contatto chiuso in 2 o più posizioni Closed contact in 2 or more positions</td> <td style="width:25%; text-align: center;">Contatto aperto Open/passing contact</td> <td style="width:25%; text-align: center;">Contatto chiuso Closed contact</td> <td style="width:25%; text-align: center;">Autoritorno Spring return</td> </tr> <tr> <td style="text-align: center;">1</td> <td style="text-align: center;">2</td> <td style="text-align: center;"><input checked="" type="checkbox"/></td> <td style="text-align: center;"><input checked="" type="checkbox"/></td> <td style="text-align: center;"><input checked="" type="checkbox"/></td> <td style="text-align: center;"><input checked="" type="checkbox"/></td> <td style="text-align: center;"><input checked="" type="checkbox"/></td> </tr> <tr> <td colspan="2"></td> <td style="text-align: center;"><input checked="" type="checkbox"/></td> <td style="text-align: center;"><input checked="" type="checkbox"/></td> <td style="text-align: center;"><input checked="" type="checkbox"/></td> <td style="text-align: center;"><input checked="" type="checkbox"/></td> <td style="text-align: center;"><input checked="" type="checkbox"/></td> </tr> </table>																								1	2	Contatti in sovrapposizione Overlapping contacts	Contatto chiuso in 2 o più posizioni Closed contact in 2 or more positions	Contatto aperto Open/passing contact	Contatto chiuso Closed contact	Autoritorno Spring return	1	2	<input checked="" type="checkbox"/>	<input checked="" type="checkbox"/>	<input checked="" type="checkbox"/>	<input checked="" type="checkbox"/>	<input checked="" type="checkbox"/>			<input checked="" type="checkbox"/>	<input checked="" type="checkbox"/>	<input checked="" type="checkbox"/>	<input checked="" type="checkbox"/>	<input checked="" type="checkbox"/>
1	2	Contatti in sovrapposizione Overlapping contacts	Contatto chiuso in 2 o più posizioni Closed contact in 2 or more positions	Contatto aperto Open/passing contact	Contatto chiuso Closed contact	Autoritorno Spring return																																								
1	2	<input checked="" type="checkbox"/>	<input checked="" type="checkbox"/>	<input checked="" type="checkbox"/>	<input checked="" type="checkbox"/>	<input checked="" type="checkbox"/>																																								
		<input checked="" type="checkbox"/>	<input checked="" type="checkbox"/>	<input checked="" type="checkbox"/>	<input checked="" type="checkbox"/>	<input checked="" type="checkbox"/>																																								
		<table style="width:100%; border-collapse: collapse;"> <tr> <td style="width:33%;">Corpo / Body shape: <input type="checkbox"/> Quadrato / Square - GX❶ <input type="checkbox"/> Rotondo / Round - GN</td> <td style="width:33%;">Versione / Version: <input type="checkbox"/> Montaggio frontale / Front mount <input type="checkbox"/> Montaggio sul retro / Rear mount <input type="checkbox"/> In cassetta Enclosed</td> <td style="width:33%;">Corrente nominale / Amp rating _____</td> </tr> <tr> <td>Finitura / Finish: <input type="checkbox"/> Standard❷ / Standard❷ <input type="checkbox"/> Maniglia rosso/gialla / Red/yellow padlockable</td> <td><input type="checkbox"/> Altro / Other _____</td> <td></td> </tr> <tr> <td>Fissaggio / Fixing: <input type="checkbox"/> 2 viti / 2 screw <input type="checkbox"/> 4 viti / 4 screw</td> <td><input type="checkbox"/> Speciale / Special _____</td> <td></td> </tr> </table> <p>Q.tà / Qty: _____ Ragione sociale e persona di riferimento / Company name and contact details: _____</p> <p>❶ 40A nominali massimi per serie GX / Maximum 40A rating for GX series. ❷ La finitura standard ha la mostrina frontale grigia, le indicazioni 0-12 e la manopola nera. Altre tipologie sono considerate speciali / Standard finish is grey front plate, 0-12 indication and a black handle; any other is considered special.</p>																								Corpo / Body shape: <input type="checkbox"/> Quadrato / Square - GX❶ <input type="checkbox"/> Rotondo / Round - GN	Versione / Version: <input type="checkbox"/> Montaggio frontale / Front mount <input type="checkbox"/> Montaggio sul retro / Rear mount <input type="checkbox"/> In cassetta Enclosed	Corrente nominale / Amp rating _____	Finitura / Finish: <input type="checkbox"/> Standard❷ / Standard❷ <input type="checkbox"/> Maniglia rosso/gialla / Red/yellow padlockable	<input type="checkbox"/> Altro / Other _____		Fissaggio / Fixing: <input type="checkbox"/> 2 viti / 2 screw <input type="checkbox"/> 4 viti / 4 screw	<input type="checkbox"/> Speciale / Special _____													
Corpo / Body shape: <input type="checkbox"/> Quadrato / Square - GX❶ <input type="checkbox"/> Rotondo / Round - GN	Versione / Version: <input type="checkbox"/> Montaggio frontale / Front mount <input type="checkbox"/> Montaggio sul retro / Rear mount <input type="checkbox"/> In cassetta Enclosed	Corrente nominale / Amp rating _____																																												
Finitura / Finish: <input type="checkbox"/> Standard❷ / Standard❷ <input type="checkbox"/> Maniglia rosso/gialla / Red/yellow padlockable	<input type="checkbox"/> Altro / Other _____																																													
Fissaggio / Fixing: <input type="checkbox"/> 2 viti / 2 screw <input type="checkbox"/> 4 viti / 4 screw	<input type="checkbox"/> Speciale / Special _____																																													

Schemi commutatori a camme serie GX e GN

Circuit schemes rotary cam switches GX and GN series

Interruttori con angolo di rotazione 60°

On-Off switches with 60° switching

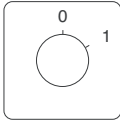
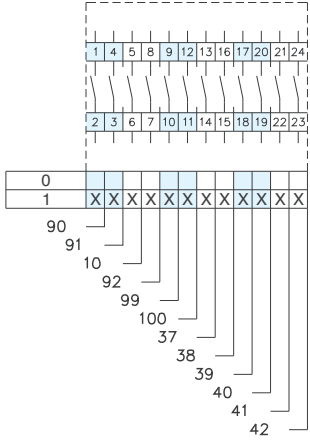
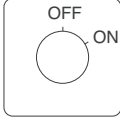
FUNZIONE FUNCTION	Mostrina Front plate	Schema Scheme	N°M elem.M N° ofM wafers	DIAGRAMMA / CONTACT CONFIGURATION		
1 polo 1 pole		90	1			
2 poli 2 pole		91	1			
3 poli 3 pole		10	2			
4 poli 4 pole		92	2			
5 poli 5 pole		99	3			
6 poli 6 pole		100	3			
7 poli 7 pole		37	4			
8 poli 8 pole		38	4			
9 poli 9 pole		39	5			
10 poli 10 pole		40	5			
11 poli 11 pole		41	6			
12 poli 12 pole		42	6			
1 polo 1 pole			D90		1	
2 poli 2 pole			D91		1	
3 poli 3 pole	D10		2			
4 poli 4 pole	D92		2			
5 poli 5 pole	D99		3			
6 poli 6 pole	D100		3			

Interruttori con angolo di rotazione 90°

On-Off switches with 90° switching

FUNZIONE FUNCTION	Mostrina Front plate	Schema Scheme	N°M elem.M N° ofM wafers	DIAGRAMMA / CONTACT CONFIGURATION
1 polo 1 pole 2 poli 2 pole 3 poli 3 pole 4 poli 4 pole		05 06 07 08	1 1 2 2	
1 polo 1 pole 2 poli 2 pole 3 poli 3 pole 4 poli 4 pole		C05 C06 C07 C08	1 1 2 2	
3 poli (rotazione 360°) 3 pole (360° rotation)		09	2	
3 poli (rotazione 360°) 3 pole (360° rotation)		C09	2	
3 poli deviatore 3 pole current changeover switch		57	3	
4 poli 1 polo con chiusura anticipata 4 pole 1 pole early-make 5 poli 2 poli con chiusura anticipata 5 pole 2 pole early-make 4 poli 3 poli con chiusura anticipata 4 pole 3 pole early-make 5 poli 3 poli con chiusura anticipata 5 pole 3 pole early-make		275 277 276 278	2 3 2 3	

Schemi commutatori a camme serie GX e GN

Circuit schemes rotary cam switches GX and GN series

Interruttori a impulso con angolo di rotazione 30° con ritorno a "0"

Switches-spring return with 30° switching

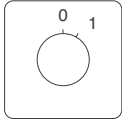
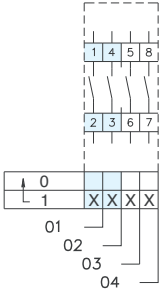
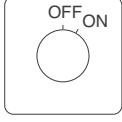
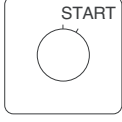
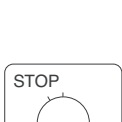
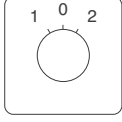
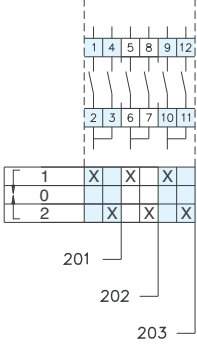
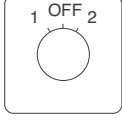
FUNZIONE FUNCTION	Mostrina Front plate	Schema Scheme	N°M elem.M N° ofM wafers	DIAGRAMMA / CONTACT CONFIGURATION	
1 polo 1 pole 2 poli 2 pole 3 poli 3 pole 4 poli 4 pole		01 02 03 04	1 1 2 2		
1 polo 1 pole 2 poli 2 pole 3 poli 3 pole 4 poli 4 pole		C01 C02 C03 C04	1 1 2 2		
1 polo 1 pole 2 poli 2 pole 3 poli 3 pole 4 poli 4 pole		D01 D02 D03 D04	1 1 2 2		
1 polo 1 pole 2 poli 2 pole 3 poli 3 pole 4 poli 4 pole		45 46 47 48	1 1 2 2		
1 polo 1 pole 2 poli 2 pole 3 poli 3 pole	con ritorno a "0" with spring return to "0"		201 202 203	1 2 3	
1 polo 1 pole 2 poli 2 pole 3 poli 3 pole	con ritorno a "0" with spring return to "0"		C201 C202 C203	1 2 3	

Commutatori con angolo di rotazione 60°

Changeover switches with "0" - 60° switching

FUNZIONE FUNCTION	Mostrina Front plate	Schema Scheme	N°M elem.M N° ofM wafers	DIAGRAMMA / CONTACT CONFIGURATION
1 polo 1 pole		51	1	
2 poli 2 pole		52	2	
3 poli 3 pole		53	3	
4 poli 4 pole		75	4	
5 poli 5 pole		76	5	
6 poli 6 pole		77	6	
7 poli 7 pole		78	7	
8 poli 8 pole		79	8	
9 poli 9 pole		80	9	
10 poli 10 pole		81	10	
11 poli 11 pole		182	1	
12 poli 12 pole		183	12	
1 polo 1 pole		D51	1	
2 poli 2 pole		D52	2	
3 poli 3 pole		D53	3	
4 poli 4 pole		D75	4	
5 poli 5 pole		D76	5	
6 poli 6 pole		D77	6	
1 polo 1 pole		E51	1	
2 poli 2 pole		E52	2	
3 poli 3 pole		E53	3	
4 poli 4 pole		E75	4	
5 poli 5 pole		E76	5	
6 poli 6 pole		E77	6	

Schemi commutatori a camme serie GX e GN

Circuit schemes rotary cam switches GX and GN series

**Deviatori con
angolo di rotazione
90°**

**Changeover
switches without
"0" - 90° switching**

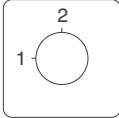
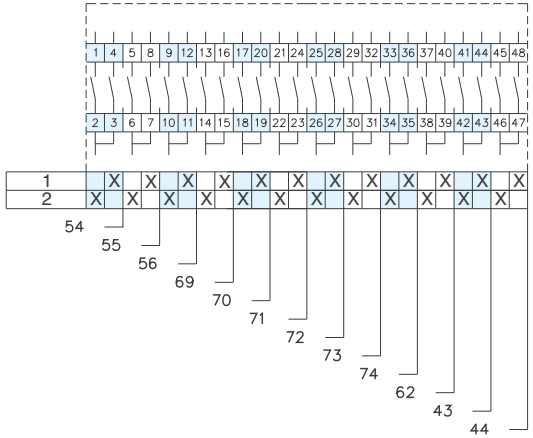
FUNZIONE FUNCTION	Mostrina Front plate	Schema Scheme	N°M elem.M N° ofM wafers	DIAGRAMMA / CONTACT CONFIGURATION
1 polo 1 pole		54	1	
2 poli 2 pole		55	2	
3 poli 3 pole		56	3	
4 poli 4 pole		69	4	
5 poli 5 pole		70	5	
6 poli 6 pole		71	6	
7 poli 7 pole		72	7	
8 poli 8 pole		73	8	
9 poli 9 pole		74	9	
10 poli 10 pole		62	10	
11 poli 11 pole		43	11	
12 poli 12 pole		44	12	

Commutatori multivie senza "0"

Multi-step switches without "0"

FUNZIONE FUNCTION	Mostrina Front plate	Schema Scheme	N°M elem.M N° ofM waters	DIAGRAMMA / CONTACT CONFIGURATION
1 polo 1 pole 2 poli 2 pole 3 poli 3 pole 4 poli 4 pole 5 poli 5 pole 6 poli 6 pole 7 poli 7 pole 8 poli 8 pole		82	2	
		86	3	
		93	5	
		141	6	
		149	8	
		154	9	
		159	11	
		162	12	
1 polo 1 pole 2 poli 2 pole 3 poli 3 pole 4 poli 4 pole 5 poli 5 pole 6 poli 6 pole		83	2	
		87	4	
		94	6	
		142	8	
		150	10	
		155	12	
1 polo 1 pole 2 poli 2 pole 3 poli 3 pole 4 poli 4 pole		84	3	
		88	5	
		95	8	
		143	10	
1 polo 1 pole 2 poli 2 pole 3 poli 3 pole 4 poli 4 pole		85	3	
		89	6	
		96	9	
		144	12	

Schemi commutatori a camme serie GX e GN

Circuit schemes rotary cam switches GX and GN series

Commutatori multivie senza "0"

Multi-step switches without "0"

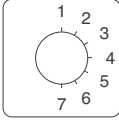
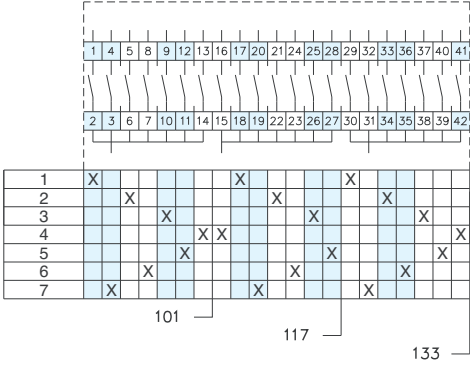
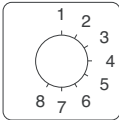
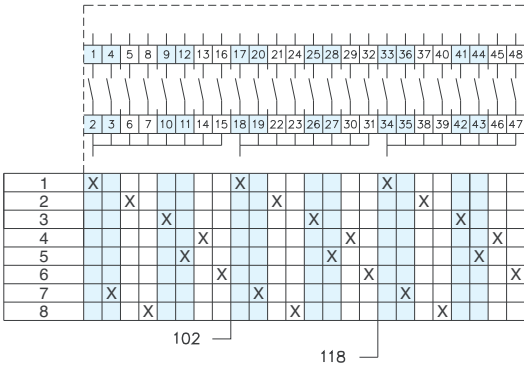
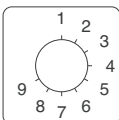
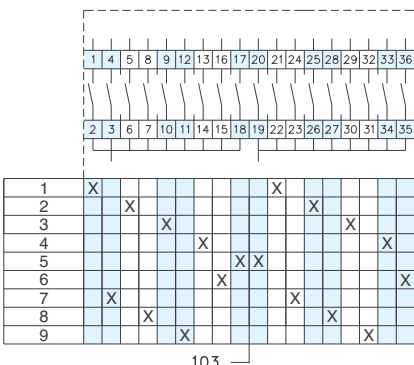
FUNZIONE FUNCTION	Mostrina Front plate	Schema Scheme	N°M elem.M N° ofM wafers	DIAGRAMMA / CONTACT CONFIGURATION
1 polo 1 pole 2 poli 2 pole 3 poli 3 pole 7 posizioni 7 positions		101 117 133	4 7 11	
1 polo 1 pole 2 poli 2 pole 3 poli 3 pole 8 posizioni 8 positions		102 118 134	4 8 12	
1 polo 1 pole 2 poli 2 pole 9 posizioni 9 positions		103 119	5 9	

Commutatori multivie senza "0"

Multi-step switches without "0"

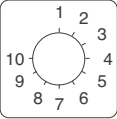
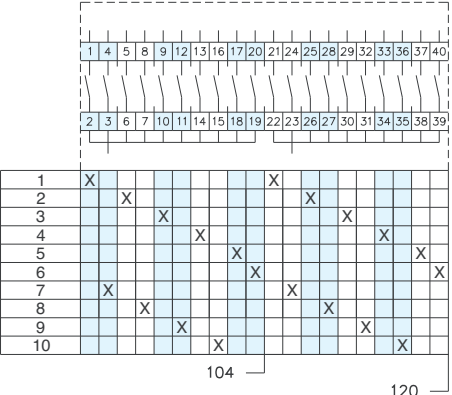
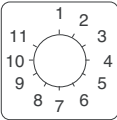
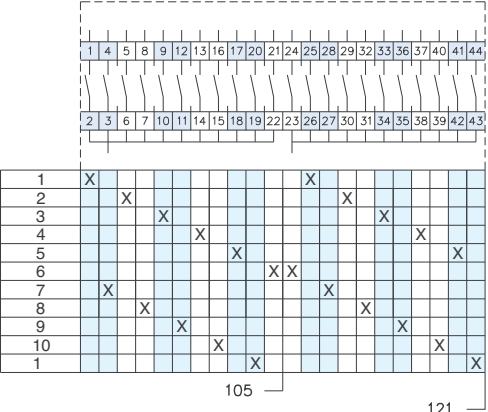
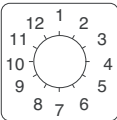
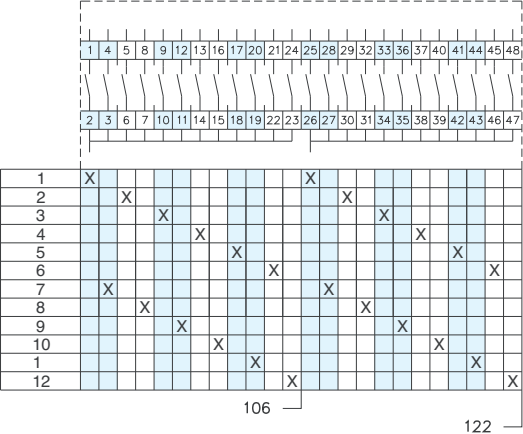
FUNZIONE FUNCTION	Mostrina Front plate	Schema Scheme	N°M elem.M N° of M waters	DIAGRAMMA / CONTACT CONFIGURATION
1 polo 1 pole 2 poli 2 pole 10 posizioni 10 positions		104 120	5 10	
1 polo 1 pole 2 poli 2 pole 11 posizioni 11 positions		105 121	6 11	
1 polo 1 pole 2 poli 2 pole 12 posizioni 12 positions		106 122	6 12	

Schemi commutatori a camme serie GX e GN

Circuit schemes rotary cam switches GX and GN series

Commutatori multivie con "0"

Multi-step switches with "0"

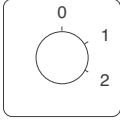
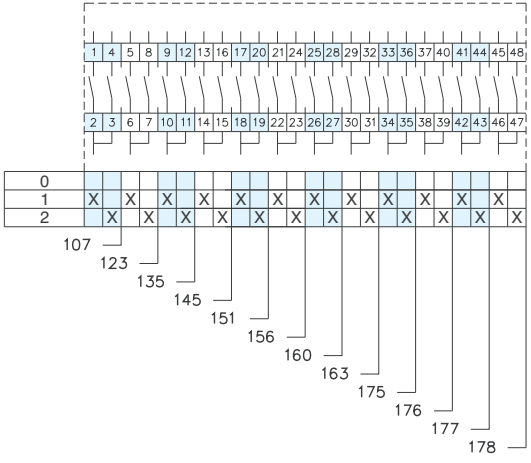
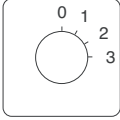
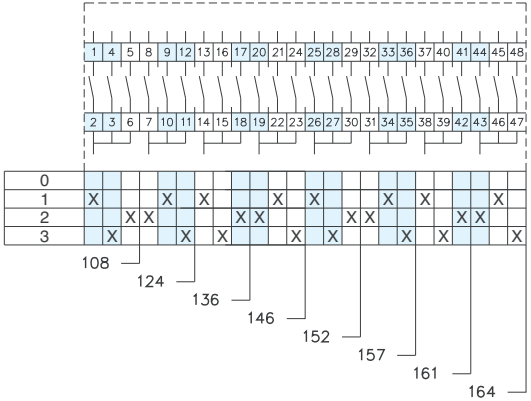
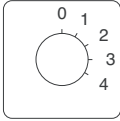
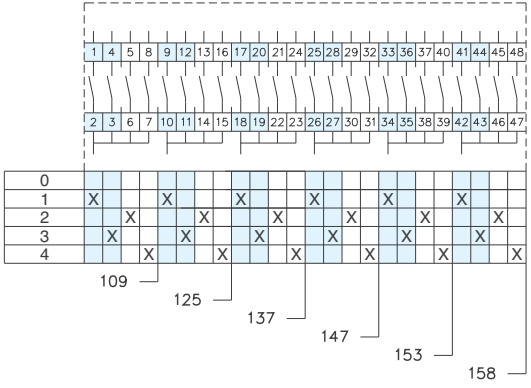
FUNZIONE FUNCTION	Mostrina Front plate	Schema Scheme	N°M elem.M N° ofM wafers	DIAGRAMMA / CONTACT CONFIGURATION			
1 polo 1 pole 2 poli 2 pole 3 poli 3 pole 4 poli 4 pole 5 poli 5 pole 6 poli 6 pole 7 poli 7 pole 8 poli 8 pole 9 poli 9 pole 10 poli 10 pole 11 poli 11 pole 12 poli 12 pole 12 pole	 2 posizioni 2 positions	107	1				
		123	2				
		135	3				
		145	4				
		151	5				
		156	6				
		160	7				
		163	8				
		175	9				
		176	10				
		177	11				
		178	12				
1 polo 1 pole 2 polna 2 pole 3 polna 3 pole 4 polna 4 pole 5 polna 5 pole 6 polna 6 pole 7 polna 7 pole 8 polna 8 pole 8 pole	 3 posizioni 3 positions	108	2				
		124	3				
		136	5				
		146	6				
		152	8				
		157	9				
		161	11				
		164	12				
		1 polo 1 pole 2 poli 2 pole 3 poli 3 pole 4 poli 4 pole 5 poli 5 pole 6 poli 6 pole	 4 posizioni 4 positions		109	2	
					125	4	
					137	6	
					147	8	
153	10						
158	12						

Commutatori multivie con "0"

Multi-step switches with "0"

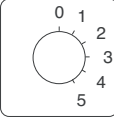
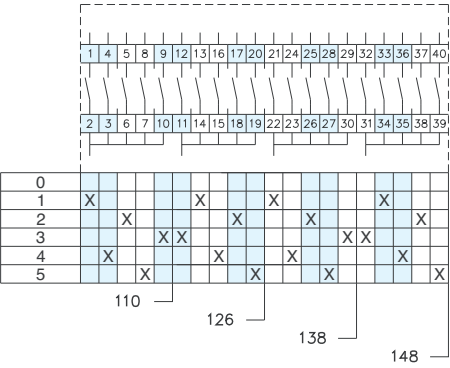
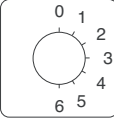
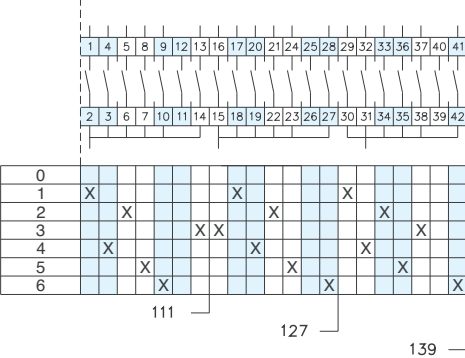
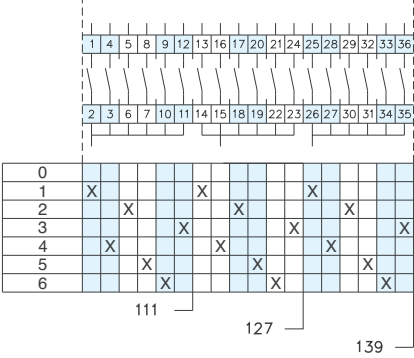
FUNZIONE FUNCTION	Mostrina Front plate	Schema Scheme	N°M elem.M N° ofM waters	DIAGRAMMA / CONTACT CONFIGURATION
1 polo 1 pole 2 poli 2 pole 3 poli 3 pole 4 poli 4 pole 5 posizioni 5 positions		110 126 138 148	3 5 8 10	
1 polo 1 pole 2 poli 2 pole 3 poli 3 pole 3 poli 3 pole 6 posizioni 6 positions		111 127 139	4 7 11	 <p>per / for GN63</p>
		111 127 139	3 6 9	 <p>per / for GX serie / series, GN12 - GN40, GN125</p>

Schemi commutatori a camme serie GX e GN

Circuit schemes rotary cam switches GX and GN series

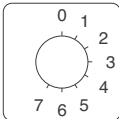
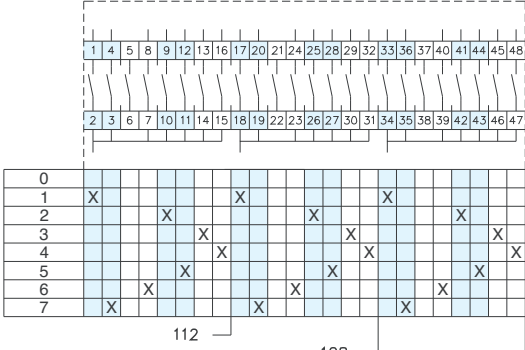
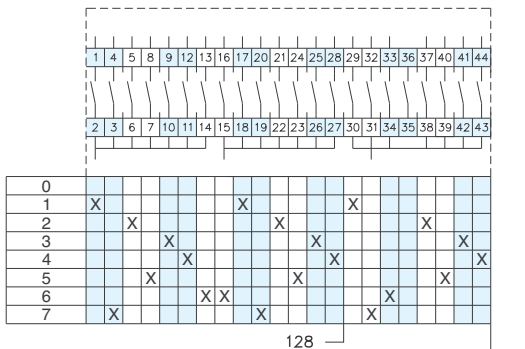

Commutatori multivie con "0"

Multi-step switches with "0"

FUNZIONE FUNCTION	Mostrina Front plate	Schema Scheme	N°M elem.M N° ofM wafers	DIAGRAMMA / CONTACT CONFIGURATION
2 poli 2 pole 3 poli 3 pole 7 posizioni 7 positions		112 128** 140**	4 8 12	 <p>** per/for GN63</p>
		128 140	7 11	 <p>per / for GX serie / series, GN25, GN40, GN125</p>

Commutatori multivie con "0"

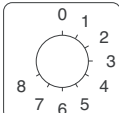
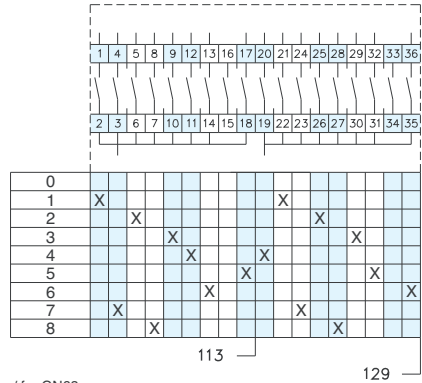
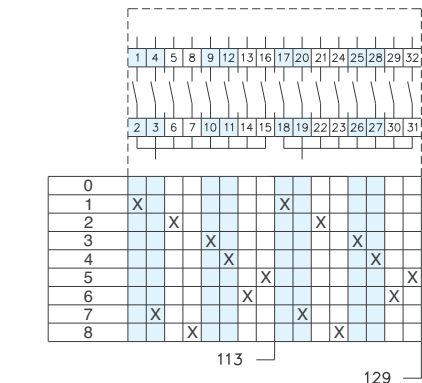
Multi-step switches with "0"

FUNZIONE FUNCTION	Mostrina Front plate	Schema Scheme	N°M elem.M N° ofM wafers	DIAGRAMMA / CONTACT CONFIGURATION
1 polo 1 pole 2 poli 2 pole 8 posizioni 8 positions		113	5	 <p>per / for GN63</p>
		129	9	 <p>per / for GN63</p>
		113	4	 <p>per / for GX serie / series, GN12 - GN40, GN125</p>
		129	8	 <p>per / for GX serie / series, GN12 - GN40, GN125</p>

Schemi commutatori a camme serie GX e GN

Circuit schemes rotary cam switches GX and GN series

Commutatori multivie con "0"

Multi-step switches with "0"

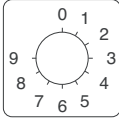
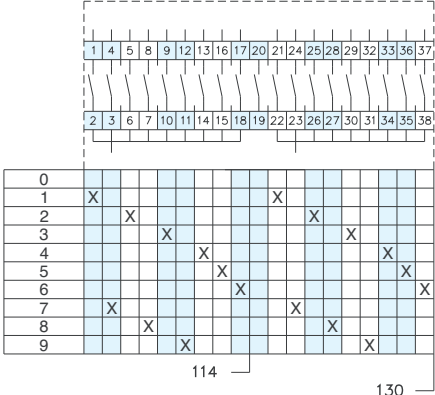
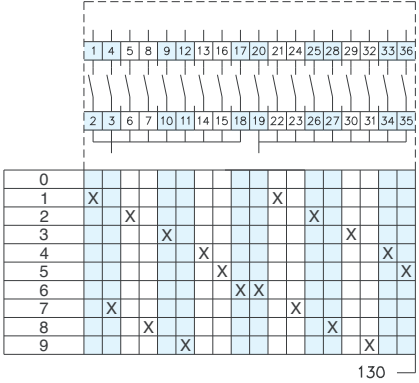
FUNZIONE FUNCTION	Mostrina Front plate	Schema Scheme	N°M elem.M N° ofM wafers	DIAGRAMMA / CONTACT CONFIGURATION
<p>1 polo 1 pole</p> <p>2 poli 2 pole</p> <p>9 posizioni 9 positions</p>		<p>114</p> <p>130**</p>	<p>5</p> <p>10</p>	 <p>** per / for GN63</p>
		<p>130</p>	<p>9</p>	 <p>per / for GX serie / series, GN12 - GN40, GN125</p>

Commutatori multivie con "0"

Multi-step switches with "0"

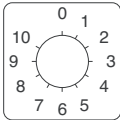
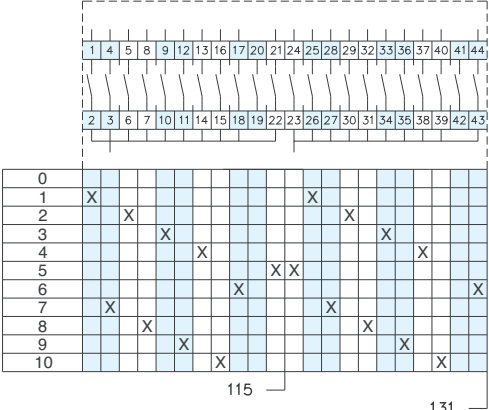
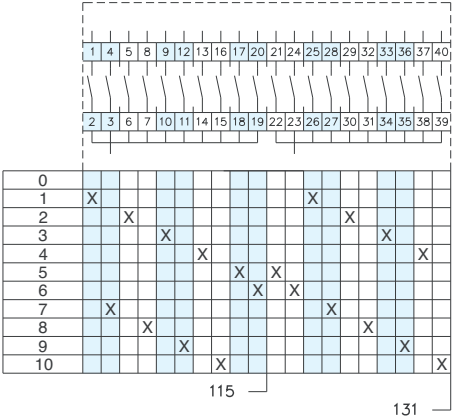
FUNZIONE FUNCTION	Mostrina Front plate	Schema Scheme	N°M elem.M N° ofM wafers	DIAGRAMMA / CONTACT CONFIGURATION
1 polo 1 pole 2 poli 2 pole 10 posizioni 10 positions		115 131	6 11	 <p>per / for GN63</p>
		11 131	5 10	 <p>per / for GX serie / series, GN12 - GN40, GN125</p>

Schemi commutatori a camme serie GX e GN

Circuit schemes rotary cam switches GX and GN series

Commutatori multivie con "0"

Multi-step switches with "0"

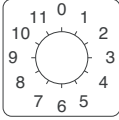
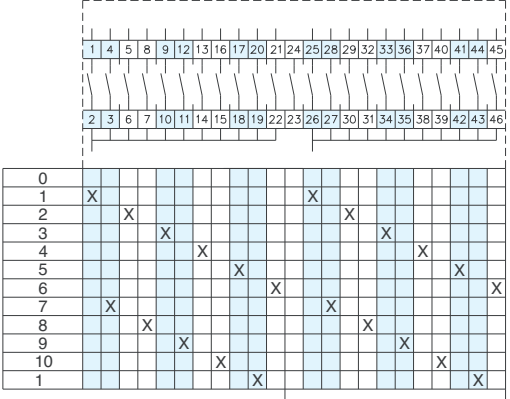
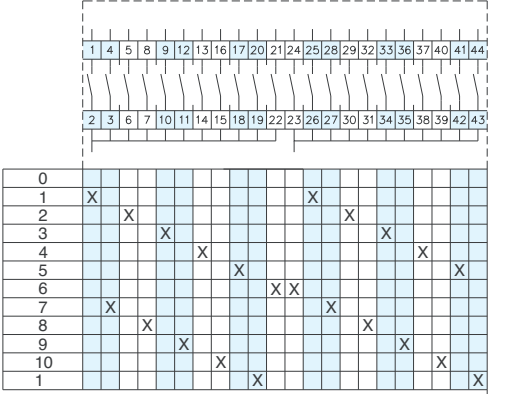
FUNZIONE FUNCTION	Mostrina Front plate	Schema Scheme	N°M elem.M N° ofM wafers	DIAGRAMMA / CONTACT CONFIGURATION
1 polo 1 pole 2 poli 2 pole 11 posizioni 11 positions		116	6	 <p style="text-align: center;">116</p> <p style="text-align: right;">132</p> <p>** per / for GN63</p>
		132**	12	 <p style="text-align: right;">132</p> <p>per / for GX serie / series, GN12 - GN40, GN125</p>

Commutatori a gruppi

Gang switches

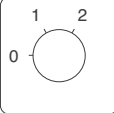
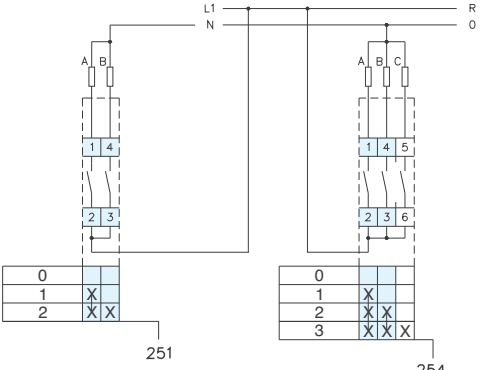
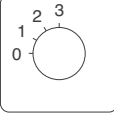
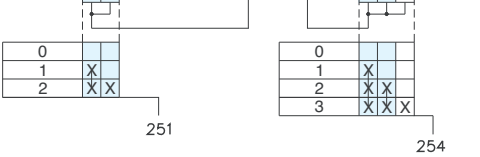
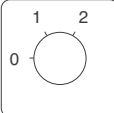
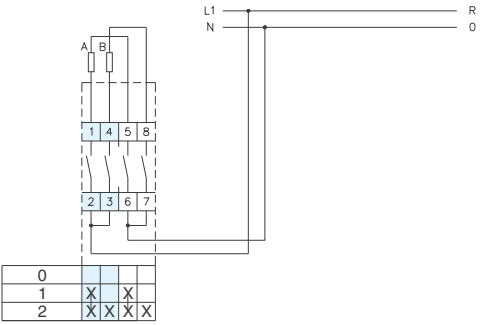
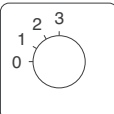
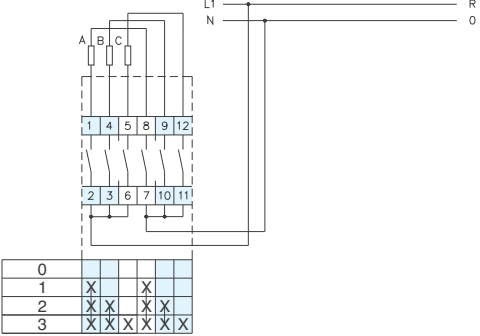
FUNZIONE FUNCTION	Mostrina Front plate	Schema Scheme	N°M elem.M N° ofM waters	DIAGRAMMA / CONTACT CONFIGURATION
2 GRUPPI Sequenza: 0, A, A+B 2 GANG Switching sequence: 0, A, A+B 1 polo 1 pole		251	1	
3 GRUPPI Sequenza: 0, A, A+B, A+B+C 3 GANG Switching sequence: 0, A, A+B, A+B+C		254	2	
2 GRUPPI Sequenza: 0, A, A+B 2 GANG Switching sequence: 0, A, A+B 2 poli 2 pole		252	2	
3 GRUPPI Sequenza: 0, A, A+B, A+B+C 3 GANG Switching sequence: 0, A, A+B, A+B+C 2 poli 2 pole		255	3	

Schemi commutatori a camme serie GX e GN

Circuit schemes rotary cam switches GX and GN series

Commutatori a gruppi

Gang switches

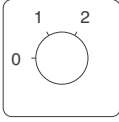
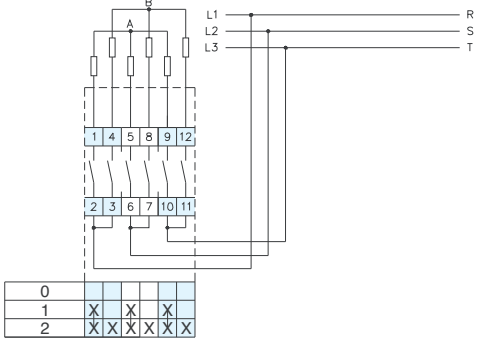
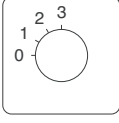
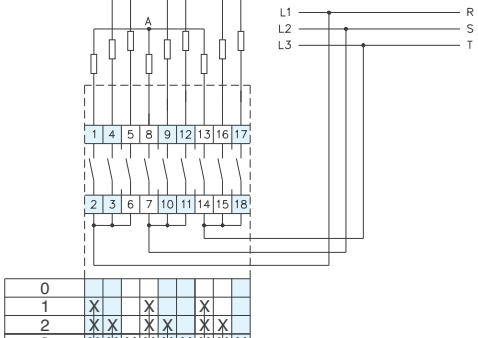
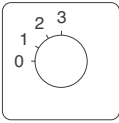
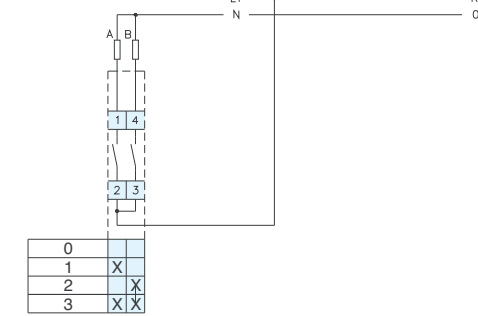
FUNZIONE FUNCTION	Mostrina Front plate	Schema Scheme	N°M elem.M N° ofM wafers	DIAGRAMMA / CONTACT CONFIGURATION																																																																								
<p>2 GRUPPI Sequenza: 0, A, A+B 2 GANG Switching sequence: 0, A, A+B</p>		253	3	 <table border="1" data-bbox="944 645 1136 698"> <tr><td>0</td><td></td><td></td><td></td><td></td><td></td><td></td><td></td><td></td><td></td><td></td><td></td></tr> <tr><td>1</td><td>X</td><td></td><td>X</td><td>X</td><td>X</td><td></td><td></td><td></td><td></td><td></td><td></td></tr> <tr><td>2</td><td>X</td><td>X</td><td>X</td><td>X</td><td>X</td><td>X</td><td>X</td><td>X</td><td>X</td><td>X</td><td>X</td></tr> </table>	0												1	X		X	X	X							2	X	X	X	X	X	X	X	X	X	X	X																																				
0																																																																												
1	X		X	X	X																																																																							
2	X	X	X	X	X	X	X	X	X	X	X																																																																	
<p>3 GRUPPI Sequenza: 0, A, A+B, A+B+C 3 GANG Switching sequence: 0, A, A+B, A+B+C</p>		256	5	 <table border="1" data-bbox="944 1086 1193 1153"> <tr><td>0</td><td></td><td></td><td></td><td></td><td></td><td></td><td></td><td></td><td></td><td></td><td></td><td></td><td></td><td></td><td></td><td></td><td></td></tr> <tr><td>1</td><td>X</td><td></td><td></td><td></td><td></td><td>X</td><td></td><td></td><td></td><td></td><td>X</td><td></td><td></td><td></td><td></td><td>X</td><td></td></tr> <tr><td>2</td><td>X</td><td>X</td><td></td><td></td><td>X</td><td>X</td><td>X</td><td>X</td><td>X</td><td>X</td><td>X</td><td>X</td><td>X</td><td>X</td><td>X</td><td>X</td><td>X</td></tr> <tr><td>3</td><td>X</td><td>X</td><td>X</td><td>X</td><td>X</td><td>X</td><td>X</td><td>X</td><td>X</td><td>X</td><td>X</td><td>X</td><td>X</td><td>X</td><td>X</td><td>X</td><td>X</td></tr> </table>	0																		1	X					X					X					X		2	X	X			X	X	X	X	X	X	X	X	X	X	X	X	X	3	X	X	X	X	X	X	X	X	X	X	X	X	X	X	X	X	X
0																																																																												
1	X					X					X					X																																																												
2	X	X			X	X	X	X	X	X	X	X	X	X	X	X	X																																																											
3	X	X	X	X	X	X	X	X	X	X	X	X	X	X	X	X	X																																																											
<p>2 GRUPPI Sequenza: 0, A, B, A+B 2 GANG Switching sequence: 0, A, B, A+B</p>		257	1	 <table border="1" data-bbox="970 1473 1088 1550"> <tr><td>0</td><td></td><td></td></tr> <tr><td>1</td><td>X</td><td></td></tr> <tr><td>2</td><td>X</td><td>X</td></tr> <tr><td>3</td><td>X</td><td>X</td></tr> </table>	0			1	X		2	X	X	3	X	X																																																												
0																																																																												
1	X																																																																											
2	X	X																																																																										
3	X	X																																																																										

Commutatori a gruppi

Gang switches

FUNZIONE FUNCTION	Mostrina Front plate	Schema Scheme	N°M elem.M N° ofM wafers	DIAGRAMMA / CONTACT CONFIGURATION																														
<p>2 GRUPPI Sequenza: 0, A, B, A+B 2 GANG Switching sequence: 0, A, B, A+B</p>		258	2	<table border="1" data-bbox="1002 609 1161 689"> <tr><td>0</td><td></td><td></td><td></td><td></td></tr> <tr><td>1</td><td>X</td><td></td><td>X</td><td></td></tr> <tr><td>2</td><td></td><td>X</td><td>X</td><td>X</td></tr> <tr><td>3</td><td>X</td><td>X</td><td>X</td><td>X</td></tr> </table>	0					1	X		X		2		X	X	X	3	X	X	X	X										
0																																		
1	X		X																															
2		X	X	X																														
3	X	X	X	X																														
<p>3 GRUPPI Sequenza: 0, A, B, A+B 2 GANG Switching sequence: 0, A, B, A+B</p>		259	3	<table border="1" data-bbox="1002 1079 1193 1160"> <tr><td>0</td><td></td><td></td><td></td><td></td><td></td></tr> <tr><td>1</td><td>X</td><td></td><td>X</td><td>X</td><td></td></tr> <tr><td>2</td><td></td><td>X</td><td>X</td><td>X</td><td>X</td></tr> <tr><td>3</td><td>X</td><td>X</td><td>X</td><td>X</td><td>X</td></tr> </table>	0						1	X		X	X		2		X	X	X	X	3	X	X	X	X	X						
0																																		
1	X		X	X																														
2		X	X	X	X																													
3	X	X	X	X	X																													
<p>2 GRUPPI Sequenza: 0, A+B serie, A, B, A+B parallelo 2 GANG Switching sequence: 0, A+B series, A, B, A+B parallel</p>		260	2	<table border="1" data-bbox="1002 1473 1161 1572"> <tr><td>0</td><td></td><td></td><td></td><td></td><td></td></tr> <tr><td>1</td><td>X</td><td></td><td></td><td></td><td>X</td></tr> <tr><td>2</td><td>X</td><td>X</td><td></td><td></td><td></td></tr> <tr><td>3</td><td></td><td>X</td><td>X</td><td></td><td></td></tr> <tr><td>4</td><td>X</td><td>X</td><td>X</td><td></td><td></td></tr> </table>	0						1	X				X	2	X	X				3		X	X			4	X	X	X		
0																																		
1	X				X																													
2	X	X																																
3		X	X																															
4	X	X	X																															

Schemi commutatori a camme serie GX e GN

Circuit schemes rotary cam switches GX and GN series

Commutatori voltmetrici

Voltmeter switches

FUNZIONE FUNCTION	Mostrina Front plate	Schema Scheme	N°M elem.M N° ofM wafers	DIAGRAMMA / CONTACT CONFIGURATION																																			
3 tensioni di linea 1 tensione di fase 3 line voltage and 1 phase voltage		60	3	<table border="1"> <tr><td>L1N</td><td>X</td><td></td><td></td><td>X</td></tr> <tr><td>0</td><td>X</td><td></td><td></td><td></td></tr> <tr><td>L1L2</td><td>X</td><td></td><td>X</td><td></td></tr> <tr><td>L2L3</td><td>X</td><td>X</td><td>X</td><td></td></tr> <tr><td>L3L1</td><td>X</td><td>X</td><td></td><td></td></tr> </table>	L1N	X			X	0	X				L1L2	X		X		L2L3	X	X	X		L3L1	X	X												
	L1N	X				X																																	
0	X																																						
L1L2	X		X																																				
L2L3	X	X	X																																				
L3L1	X	X																																					
		C 60	3																																				
3 tensioni di linea 3 tensioni di fase 3 line voltage and 3 phase voltage		66	3	<table border="1"> <tr><td>L3N</td><td>X</td><td></td><td></td><td>X</td></tr> <tr><td>L2N</td><td></td><td>X</td><td></td><td>X</td></tr> <tr><td>L1N</td><td></td><td></td><td>X</td><td>X</td></tr> <tr><td>0</td><td>X</td><td></td><td></td><td></td></tr> <tr><td>L1L2</td><td></td><td></td><td>X</td><td>X</td></tr> <tr><td>L2L3</td><td>X</td><td>X</td><td>X</td><td></td></tr> <tr><td>L3L1</td><td>X</td><td>X</td><td>X</td><td></td></tr> </table>	L3N	X			X	L2N		X		X	L1N			X	X	0	X				L1L2			X	X	L2L3	X	X	X		L3L1	X	X	X	
	L3N	X				X																																	
L2N		X		X																																			
L1N			X	X																																			
0	X																																						
L1L2			X	X																																			
L2L3	X	X	X																																				
L3L1	X	X	X																																				
		C 66	3																																				
3 tensioni di linea 3 line voltage		67	2	<table border="1"> <tr><td>0</td><td></td><td></td><td></td><td></td></tr> <tr><td>L1L2</td><td>X</td><td></td><td></td><td>X</td></tr> <tr><td>L2L3</td><td></td><td>X</td><td>X</td><td></td></tr> <tr><td>L3L1</td><td>X</td><td>X</td><td></td><td></td></tr> </table>	0					L1L2	X			X	L2L3		X	X		L3L1	X	X																	
	0																																						
L1L2	X			X																																			
L2L3		X	X																																				
L3L1	X	X																																					
		C 67	2																																				
3 tensioni di fase 3 phase voltage		68	2	<table border="1"> <tr><td>0</td><td></td><td></td><td></td><td></td></tr> <tr><td>L1N</td><td></td><td>X</td><td></td><td>X</td></tr> <tr><td>L2N</td><td>X</td><td></td><td></td><td>X</td></tr> <tr><td>L3N</td><td></td><td>X</td><td>X</td><td></td></tr> </table>	0					L1N		X		X	L2N	X			X	L3N		X	X																
	0																																						
L1N		X		X																																			
L2N	X			X																																			
L3N		X	X																																				
		C 68	2																																				

**Commutatori
amperometrici**

Ammeter switches

FUNZIONE FUNCTION	Mostrina Front plate	Schema Scheme	N elem. N of wafers	DIAGRAMMA / CONTACT CONFIGURATION																					
2 poli 3 correnti (con o senza trasformatore di corrente) 2 pole 3 currents (with or without current transformers)		58	5	<tr><td>L1</td><td>X</td><td></td><td>X</td><td></td><td>X</td><td>X</td></tr> <tr><td>L2</td><td></td><td>X</td><td>X</td><td></td><td></td><td></td></tr> <tr><td>L3</td><td>X</td><td>X</td><td></td><td>X</td><td></td><td>X</td></tr>	L1	X		X		X	X	L2		X	X				L3	X	X		X		X
	L1	X			X		X	X																	
	L2		X		X																				
L3	X	X		X		X																			

	C 58	5																																						
	E 58	5																																						
1 polo 3 correnti (con trasformatore di corrente) 1 pole 3 currents (with current transformer)		98	4								---	---	---	---	---		0	X	X		X		L1		X	X	X		L2	X	X		X		L3	X		X	X	
	C 98	4																																						
	E 98	4																																						

Schemi commutatori a camme serie GX e GN

Circuit schemes rotary cam switches GX and GN series

Commutatori amperometrici

Ammeter switches

FUNZIONE FUNCTION	Mostrina Front plate	Schema Scheme	N°M elem.M N° ofM wafers	DIAGRAMMA / CONTACT CONFIGURATION
2 poli posizione 0 3 correnti (con o senza trasformatore di corrente) 2 pole 0-position 3 currents (with or without current transformers)		97	6	
		C 97	6	
		E 97	6	
		97	5	
		C 97	5	
		E 97	5	

**Commutatori
voltmetrici-
amperometrici**

**Voltmeter-ammeter
switches**

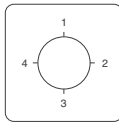
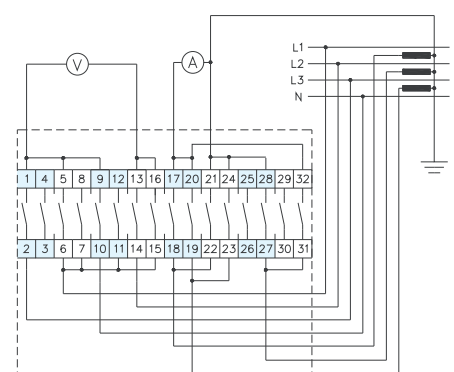
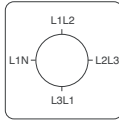
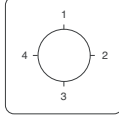
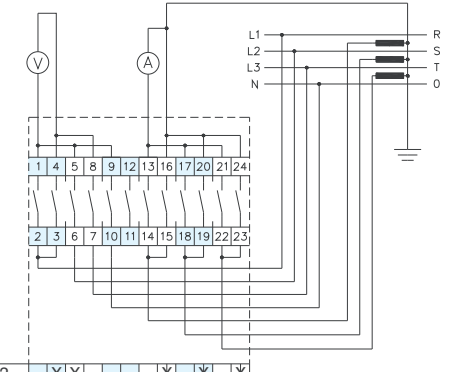
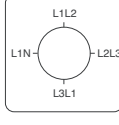
FUNZIONE FUNCTION	Mostrina Front plate	Schema Scheme	N°M elem.M N° of M waters	DIAGRAMMA / CONTACT CONFIGURATION																																																			
<p>3 tensioni di linea 1 tensione di fase 3 correnti</p> <p>3 line voltage 1 phase voltage 3 current</p> <table border="1" data-bbox="523 996 694 1108"> <thead> <tr> <th>Pos.</th> <th>Tensione Voltage</th> <th>Corrente Current</th> </tr> </thead> <tbody> <tr> <td>1</td> <td>L1L2</td> <td>-</td> </tr> <tr> <td>2</td> <td>L2L3</td> <td>L1</td> </tr> <tr> <td>3</td> <td>L3L1</td> <td>L2</td> </tr> <tr> <td>4</td> <td>L1N</td> <td>L3</td> </tr> </tbody> </table>	Pos.	Tensione Voltage	Corrente Current	1	L1L2	-	2	L2L3	L1	3	L3L1	L2	4	L1N	L3		61	8	 <table border="1" data-bbox="973 716 1348 940"> <thead> <tr> <th>L1L2</th> <th></th> <th>X</th> <th></th> <th>X</th> <th></th> <th>X</th> <th>X</th> <th>X</th> </tr> </thead> <tbody> <tr> <th>L2L3</th> <td>X</td> <td></td> <td></td> <td>X</td> <td>X</td> <td></td> <td>X</td> <td>X</td> </tr> <tr> <th>L3L1</th> <td>X</td> <td></td> <td></td> <td>X</td> <td>X</td> <td>X</td> <td></td> <td>X</td> </tr> <tr> <th>L1N</th> <td></td> <td></td> <td>X</td> <td>X</td> <td>X</td> <td>X</td> <td></td> <td>X</td> </tr> </tbody> </table> <p>per / for GN63</p>	L1L2		X		X		X	X	X	L2L3	X			X	X		X	X	L3L1	X			X	X	X		X	L1N			X	X	X	X		X
	Pos.	Tensione Voltage	Corrente Current																																																				
1	L1L2	-																																																					
2	L2L3	L1																																																					
3	L3L1	L2																																																					
4	L1N	L3																																																					
L1L2		X		X		X	X	X																																															
L2L3	X			X	X		X	X																																															
L3L1	X			X	X	X		X																																															
L1N			X	X	X	X		X																																															
	C 61	8																																																					
		61	6	 <table border="1" data-bbox="981 1355 1284 1579"> <thead> <tr> <th>L1L2</th> <th></th> <th>X</th> <th>X</th> <th></th> <th></th> <th>X</th> <th>X</th> <th>X</th> </tr> </thead> <tbody> <tr> <th>L2L3</th> <td></td> <td>X</td> <td>X</td> <td></td> <td>X</td> <td></td> <td>X</td> <td>X</td> </tr> <tr> <th>L3L1</th> <td>X</td> <td></td> <td>X</td> <td></td> <td>X</td> <td>X</td> <td></td> <td>X</td> </tr> <tr> <th>L1N</th> <td>X</td> <td></td> <td>X</td> <td>X</td> <td>X</td> <td>X</td> <td></td> <td>X</td> </tr> </tbody> </table> <p>per / for GX serie / series.M GN12 - GN40, GN125</p>	L1L2		X	X			X	X	X	L2L3		X	X		X		X	X	L3L1	X		X		X	X		X	L1N	X		X	X	X	X		X															
	L1L2		X	X			X	X	X																																														
L2L3		X	X		X		X	X																																															
L3L1	X		X		X	X		X																																															
L1N	X		X	X	X	X		X																																															
	C 61	6																																																					

Schemi commutatori a camme serie GX e GN

Circuit schemes rotary cam switches GX and GN series

Commutatori voltmetrici- amperometrici

Voltmeter-ammeter switches

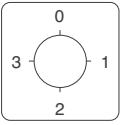
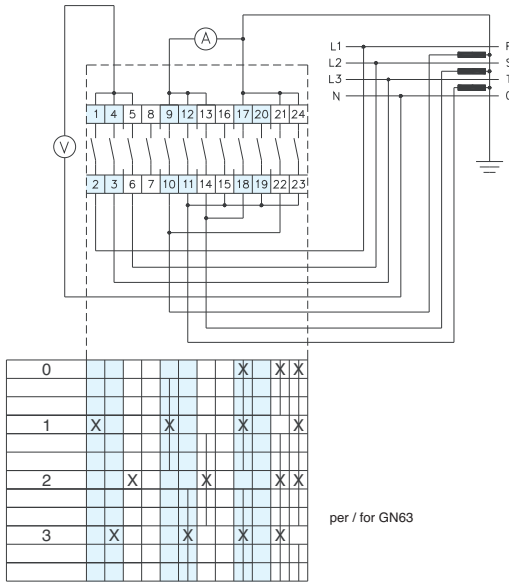
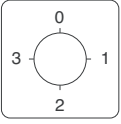
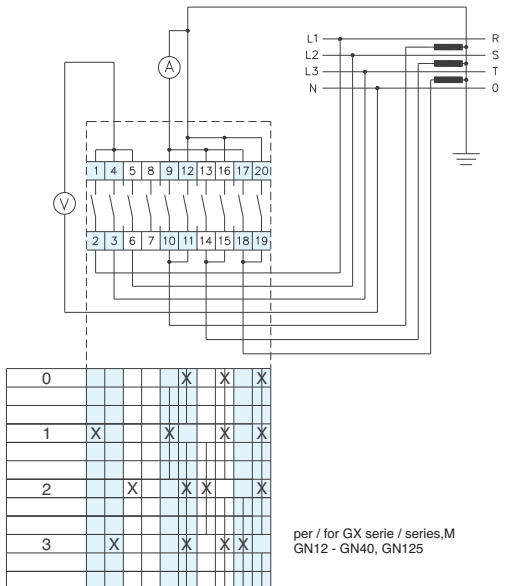
FUNZIONE FUNCTION	Mostrina Front plate	Schema Scheme	N°M elem. M N° of M wafers	DIAGRAMMA / CONTACT CONFIGURATION															
<p>3 tensioni di fase 3 correnti 3 phase voltage 3 current</p> <table border="1" data-bbox="459 967 635 1086"> <thead> <tr> <th>Pos.</th> <th>Tensione Voltage</th> <th>Corrente Current</th> </tr> </thead> <tbody> <tr> <td>0</td> <td>—</td> <td>—</td> </tr> <tr> <td>1</td> <td>L1N</td> <td>L1</td> </tr> <tr> <td>2</td> <td>L2N</td> <td>L2</td> </tr> <tr> <td>3</td> <td>L3N</td> <td>L3</td> </tr> </tbody> </table>	Pos.	Tensione Voltage	Corrente Current	0	—	—	1	L1N	L1	2	L2N	L2	3	L3N	L3		64	6	 <p>per / for GN63</p>
Pos.	Tensione Voltage	Corrente Current																	
0	—	—																	
1	L1N	L1																	
2	L2N	L2																	
3	L3N	L3																	
<table border="1" data-bbox="459 967 635 1086"> <thead> <tr> <th>Pos.</th> <th>Tensione Voltage</th> <th>Corrente Current</th> </tr> </thead> <tbody> <tr> <td>0</td> <td>—</td> <td>—</td> </tr> <tr> <td>1</td> <td>L1N</td> <td>L1</td> </tr> <tr> <td>2</td> <td>L2N</td> <td>L2</td> </tr> <tr> <td>3</td> <td>L3N</td> <td>L3</td> </tr> </tbody> </table>	Pos.	Tensione Voltage	Corrente Current	0	—	—	1	L1N	L1	2	L2N	L2	3	L3N	L3		64	5	 <p>per / for GX serie / series, M GN12 - GN40, GN125</p>
Pos.	Tensione Voltage	Corrente Current																	
0	—	—																	
1	L1N	L1																	
2	L2N	L2																	
3	L3N	L3																	

**Commutatori
voltmetrici-
amperometrici**

**Voltmeter-ammeter
switches**

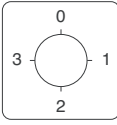
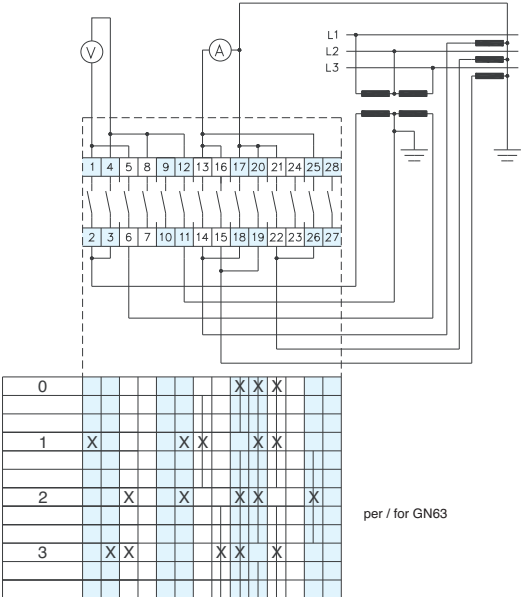
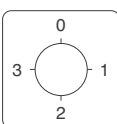
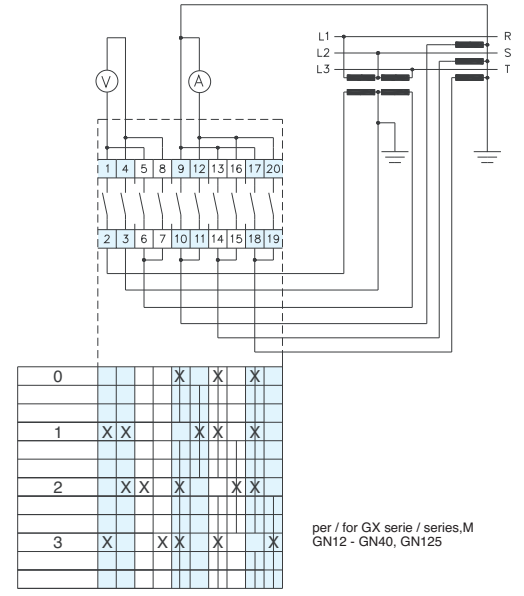
FUNZIONE FUNCTION	Mostrina Front plate	Schema Scheme	N°M elem.M N° ofM wafers	DIAGRAMMA / CONTACT CONFIGURATION															
<p>3 tensioni di linea 3 correnti 3 line voltage 3 current</p> <table border="1" data-bbox="523 969 699 1088"> <thead> <tr> <th>Pos.</th> <th>Tensione Voltage</th> <th>Corrente Current</th> </tr> </thead> <tbody> <tr> <td>0</td> <td>-</td> <td>-</td> </tr> <tr> <td>1</td> <td>L1L2</td> <td>L1</td> </tr> <tr> <td>2</td> <td>L2L3</td> <td>L2</td> </tr> <tr> <td>3</td> <td>L3L1</td> <td>L3</td> </tr> </tbody> </table>	Pos.	Tensione Voltage	Corrente Current	0	-	-	1	L1L2	L1	2	L2L3	L2	3	L3L1	L3		65	7	 <p>per / for GN63</p>
Pos.	Tensione Voltage	Corrente Current																	
0	-	-																	
1	L1L2	L1																	
2	L2L3	L2																	
3	L3L1	L3																	
<table border="1" data-bbox="523 969 699 1088"> <thead> <tr> <th>Pos.</th> <th>Tensione Voltage</th> <th>Corrente Current</th> </tr> </thead> <tbody> <tr> <td>0</td> <td>-</td> <td>-</td> </tr> <tr> <td>1</td> <td>L1L2</td> <td>L1</td> </tr> <tr> <td>2</td> <td>L2L3</td> <td>L2</td> </tr> <tr> <td>3</td> <td>L3L1</td> <td>L3</td> </tr> </tbody> </table>	Pos.	Tensione Voltage	Corrente Current	0	-	-	1	L1L2	L1	2	L2L3	L2	3	L3L1	L3		65	5	 <p>per / for GX serie / series.M GN12 - GN40, GN125</p>
Pos.	Tensione Voltage	Corrente Current																	
0	-	-																	
1	L1L2	L1																	
2	L2L3	L2																	
3	L3L1	L3																	

Schemi commutatori a camme serie GX e GN

Circuit schemes rotary cam switches GX and GN series

Interruttori (con posizioni ad impulso)

Control switches (with spring return)

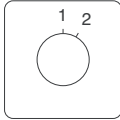
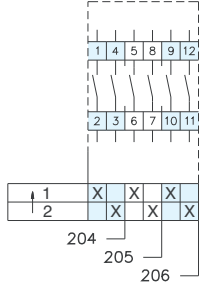
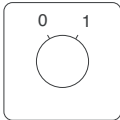
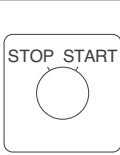
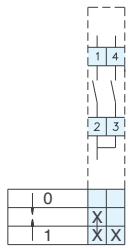
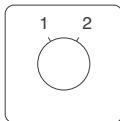
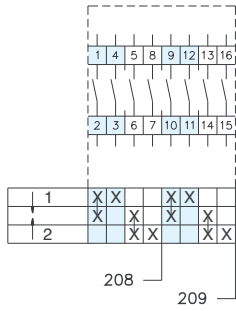
FUNZIONE FUNCTION	Mostrina Front plate	Schema Scheme	N°M elem.M N° ofM wafers	DIAGRAMMA / CONTACT CONFIGURATION
1 apertura e 1 chiusura 1 make and 1 break 2 aperture e 2 chiusure 2 makes and 2 breaks 3 aperture e 3 chiusure 3 makes and 3 breaks		204 205 206	1 2 3	
1 chiusura a destra e 1 apertura a sinistra 1 make right and 1 break left	 	207 C207	1 1	
1 chiusura, 1 apertura a destra 1 chiusura, 1 apertura a sinistra 1 make, 1 break right 1 make, 1 break left 2 chiusure, 2 aperture a destra 2 chiusure, 2 aperture a sinistra 2 makes, 2 breaks right 2 makes, 2 breaks left		208 209	2 4	

**Interruttori
(con posizioni ad impulso)**

**Control switches
(with spring return)**

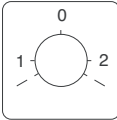
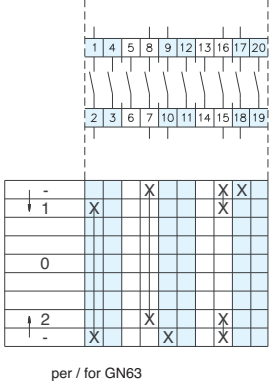
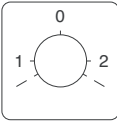
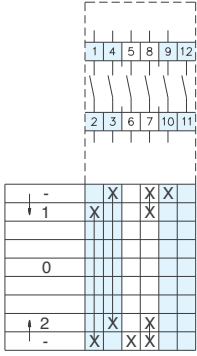
FUNZIONE FUNCTION	Mostrina Front plate	Schema Scheme	N°M elem.M N° ofM wafers	DIAGRAMMA / CONTACT CONFIGURATION
Interruttore con impulso di ritorno a sinistra e destra Switch with spring return left and right		210	5	 <p>per / for GN63</p>
Interruttore con impulso di ritorno a sinistra e destra Switch with spring return left and right		210	3	 <p>per / for GX series / seriesM GN12 - GN40, GN125</p>

Schemi commutatori a camme serie GX e GN

Circuit schemes rotary cam switches GX and GN series

Invertitori di marcia

Motor reversing switches

FUNZIONE FUNCTION	Mostrina Front plate	Schema Scheme	N°M elem.M N° ofM wafers	DIAGRAMMA / CONTACT CONFIGURATION												
3 poli 3 pole		11	3	 <table border="1"> <tr><td>1</td><td>X</td><td>X</td><td>X</td></tr> <tr><td>0</td><td></td><td></td><td></td></tr> <tr><td>2</td><td>X</td><td>X</td><td>X</td></tr> </table>	1	X	X	X	0				2	X	X	X
	1	X	X		X											
	0															
2	X	X	X													
	C11	3														
	D11	3														
2 poli ritorno da 2 a "0" 2 pole return from 2 to "0"		14	2	 <table border="1"> <tr><td>1</td><td>X</td><td>X</td></tr> <tr><td>0</td><td></td><td></td></tr> <tr><td>2</td><td>X</td><td>X</td></tr> </table>	1	X	X	0			2	X	X			
1	X	X														
0																
2	X	X														
2 poli 2 pole		24	2	 <table border="1"> <tr><td>1</td><td>X</td><td>X</td></tr> <tr><td>0</td><td></td><td></td></tr> <tr><td>2</td><td>X</td><td>X</td></tr> </table>	1	X	X	0			2	X	X			
1	X	X														
0																
2	X	X														

Invertitori di marcia

Motor reversing switches

FUNZIONE FUNCTION	Mostrina Front plate	Schema Scheme	N°M elem.M N° ofM wafers	DIAGRAMMA / CONTACT CONFIGURATION																														
2 poli ritorno a "0" 2 pole return to "0"		25	2	<table border="1" data-bbox="1013 593 1173 649"> <tr><td>1</td><td>X</td><td></td><td>X</td></tr> <tr><td>0</td><td></td><td></td><td></td></tr> <tr><td>2</td><td>X</td><td>X</td><td></td></tr> </table>	1	X		X	0				2	X	X																			
1	X		X																															
0																																		
2	X	X																																
3 poli ritorno a "0" 3 pole return to "0"		26	3	<table border="1" data-bbox="1013 963 1204 1019"> <tr><td>1</td><td>X</td><td>X</td><td>X</td></tr> <tr><td>0</td><td></td><td></td><td></td></tr> <tr><td>2</td><td>X</td><td></td><td>X</td></tr> </table>	1	X	X	X	0				2	X		X																		
1	X	X	X																															
0																																		
2	X		X																															
3 poli con contattore 3 pole with contactor		27	5	<table border="1" data-bbox="1013 1422 1284 1590"> <tr><td>START</td><td>X</td><td>X</td><td>X</td><td>X</td><td>X</td></tr> <tr><td>1</td><td></td><td>X</td><td>X</td><td>X</td><td>X</td></tr> <tr><td>0</td><td></td><td></td><td></td><td></td><td></td></tr> <tr><td>2</td><td></td><td>X</td><td>X</td><td>X</td><td>X</td></tr> <tr><td>START</td><td>X</td><td>X</td><td>X</td><td>X</td><td>X</td></tr> </table>	START	X	X	X	X	X	1		X	X	X	X	0						2		X	X	X	X	START	X	X	X	X	X
START	X	X	X	X	X																													
1		X	X	X	X																													
0																																		
2		X	X	X	X																													
START	X	X	X	X	X																													

Schemi commutatori a camme serie GX e GN

Circuit schemes rotary cam switches GX and GN series

Commutatori stella-triangolo

Star-delta switches

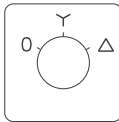
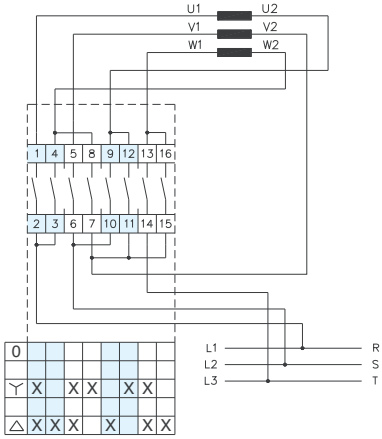
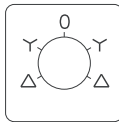
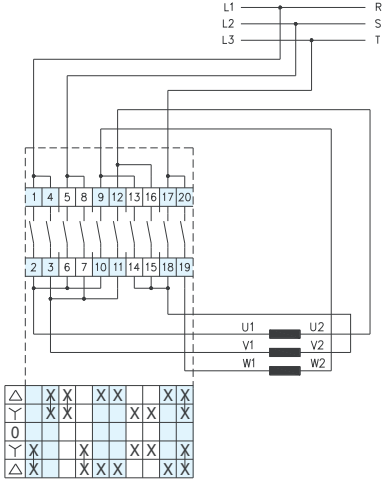
FUNZIONE FUNCTION	Mostrina Front plate	Schema Scheme	N°M elem.M N° ofM wafers	DIAGRAMMA / CONTACT CONFIGURATION
Versione standard Standard version		12	4	
Invertitore di marcia Reversing		21	5	

Commutatori stella-triangolo

Star-delta switches

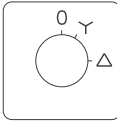
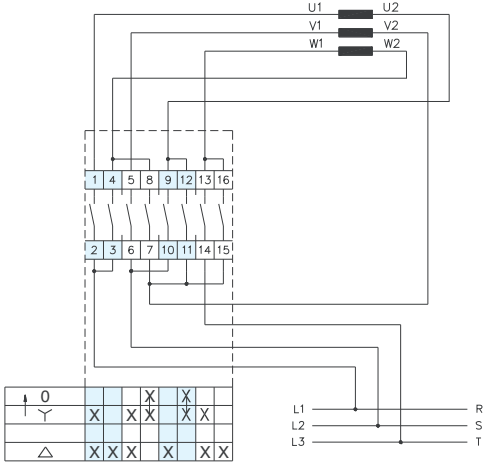
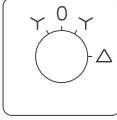
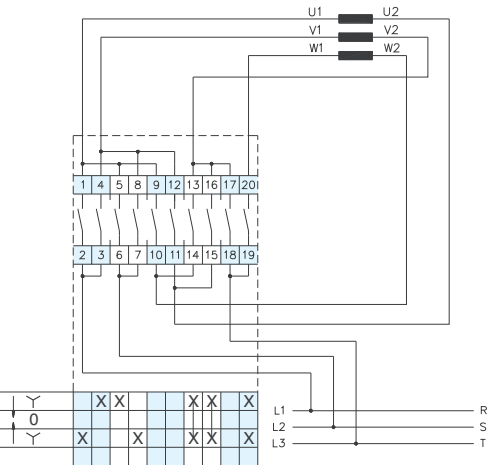
FUNZIONE FUNCTION	Mostrina Front plate	Schema Scheme	N°M elem.M N° ofM wafers	DIAGRAMMA / CONTACT CONFIGURATION																																																												
Ritorno da "Y" a "0" Return from "Y" to "0"		28	4	 <table border="1" data-bbox="991 763 1225 837"> <tr> <td>0</td> <td></td> <td></td> <td>X</td> <td>X</td> <td></td> <td></td> <td></td> <td></td> <td></td> <td></td> <td></td> <td></td> <td></td> <td></td> <td></td> <td></td> <td></td> <td></td> <td></td> </tr> <tr> <td>Y</td> <td>X</td> <td>X</td> <td>X</td> <td>X</td> <td>X</td> <td>X</td> <td>X</td> <td>X</td> <td>X</td> <td>X</td> <td>X</td> <td>X</td> <td>X</td> <td>X</td> <td>X</td> <td>X</td> <td>X</td> <td>X</td> <td>X</td> </tr> <tr> <td>Δ</td> <td>X</td> <td>X</td> <td>X</td> <td>X</td> <td>X</td> <td>X</td> <td>X</td> <td>X</td> <td>X</td> <td>X</td> <td>X</td> <td>X</td> <td>X</td> <td>X</td> <td>X</td> <td>X</td> <td>X</td> <td>X</td> <td>X</td> </tr> </table>	0			X	X																Y	X	X	X	X	X	X	X	X	X	X	X	X	X	X	X	X	X	X	X	Δ	X	X	X	X	X	X	X	X	X	X	X	X	X	X	X	X	X	X	X
0			X	X																																																												
Y	X	X	X	X	X	X	X	X	X	X	X	X	X	X	X	X	X	X	X																																													
Δ	X	X	X	X	X	X	X	X	X	X	X	X	X	X	X	X	X	X	X																																													
Frenatura in controcorrente Counter current braking		29	5	 <table border="1" data-bbox="991 1413 1251 1487"> <tr> <td>Y</td> <td></td> <td></td> <td>X</td> <td>X</td> <td></td> <td></td> <td></td> <td></td> <td></td> <td></td> <td></td> <td></td> <td></td> <td></td> <td></td> <td></td> <td></td> <td></td> <td></td> </tr> <tr> <td>0</td> <td>X</td> <td></td> <td></td> <td></td> <td>X</td> <td></td> <td></td> <td></td> <td></td> <td>X</td> <td>X</td> <td>X</td> <td>X</td> <td>X</td> <td>X</td> <td>X</td> <td>X</td> <td>X</td> <td>X</td> </tr> <tr> <td>Δ</td> <td>X</td> <td></td> <td>X</td> <td>X</td> <td>X</td> <td>X</td> <td>X</td> <td>X</td> <td>X</td> <td>X</td> <td>X</td> <td>X</td> <td>X</td> <td>X</td> <td>X</td> <td>X</td> <td>X</td> <td>X</td> <td>X</td> </tr> </table>	Y			X	X																0	X				X					X	X	X	X	X	X	X	X	X	X	Δ	X		X	X	X	X	X	X	X	X	X	X	X	X	X	X	X	X	X
Y			X	X																																																												
0	X				X					X	X	X	X	X	X	X	X	X	X																																													
Δ	X		X	X	X	X	X	X	X	X	X	X	X	X	X	X	X	X	X																																													

Schemi commutatori a camme serie GX e GN

Circuit schemes rotary cam switches GX and GN series

Commutatori stella-triangolo

Star-delta switches

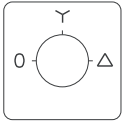
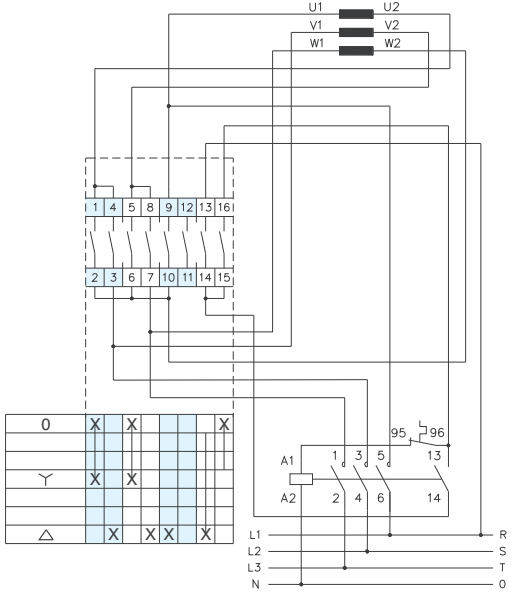
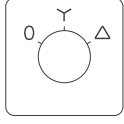
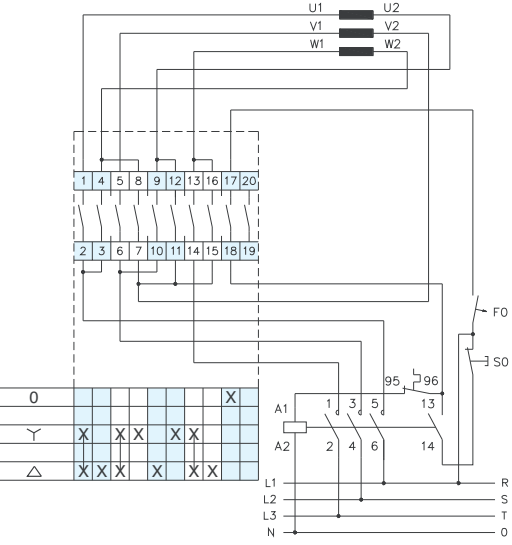
FUNZIONE FUNCTION	Mostrina Front plate	Schema Scheme	N°M elem.M N° ofM wafers	DIAGRAMMA / CONTACT CONFIGURATION																																																															
<p>Con contattore With contactor</p>		31	4	 <table border="1" data-bbox="930 763 1166 898"> <tr> <td>0</td> <td>X</td> <td>X</td> <td></td> <td></td> <td></td> <td></td> <td></td> <td></td> <td></td> <td></td> <td></td> <td></td> <td></td> <td></td> <td></td> <td></td> <td></td> <td></td> <td></td> <td></td> </tr> <tr> <td>Y</td> <td>X</td> <td>X</td> <td></td> <td></td> <td></td> <td></td> <td></td> <td></td> <td></td> <td></td> <td></td> <td></td> <td></td> <td></td> <td></td> <td></td> <td></td> <td></td> <td></td> <td></td> </tr> <tr> <td>Δ</td> <td>X</td> <td></td> <td>X</td> <td>X</td> <td>X</td> <td></td> <td></td> <td></td> <td></td> <td></td> <td></td> <td></td> <td></td> <td></td> <td></td> <td></td> <td></td> <td></td> <td></td> <td></td> </tr> </table>	0	X	X																			Y	X	X																			Δ	X		X	X	X															
0	X	X																																																																	
Y	X	X																																																																	
Δ	X		X	X	X																																																														
<p>Con contatto in posizione "0" With contact in "0" position</p>		49	5	 <table border="1" data-bbox="930 1384 1166 1480"> <tr> <td>0</td> <td></td> <td></td> <td></td> <td></td> <td></td> <td></td> <td></td> <td></td> <td></td> <td></td> <td></td> <td></td> <td></td> <td></td> <td></td> <td></td> <td></td> <td></td> <td></td> <td>X</td> </tr> <tr> <td>Y</td> <td>X</td> <td>X</td> <td>X</td> <td>X</td> <td>X</td> <td>X</td> <td>X</td> <td></td> <td></td> <td></td> <td></td> <td></td> <td></td> <td></td> <td></td> <td></td> <td></td> <td></td> <td></td> <td></td> </tr> <tr> <td>Δ</td> <td>X</td> <td>X</td> <td>X</td> <td>X</td> <td>X</td> <td>X</td> <td>X</td> <td>X</td> <td>X</td> <td></td> <td></td> <td></td> <td></td> <td></td> <td></td> <td></td> <td></td> <td></td> <td></td> <td></td> </tr> </table>	0																				X	Y	X	X	X	X	X	X	X														Δ	X	X	X	X	X	X	X	X	X											
0																				X																																															
Y	X	X	X	X	X	X	X																																																												
Δ	X	X	X	X	X	X	X	X	X																																																										

Commutatori di polarità (Dahlander)

Motor control switches (Dahlander)

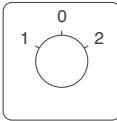
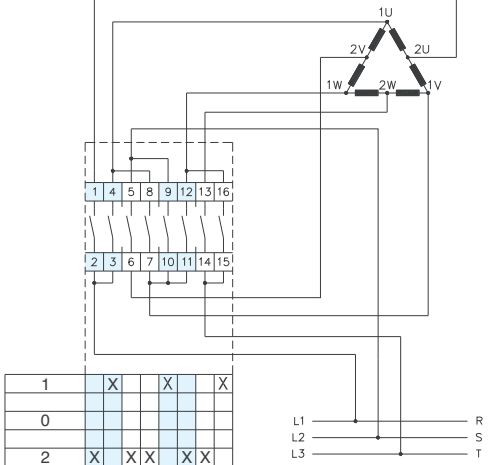
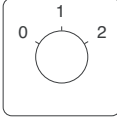
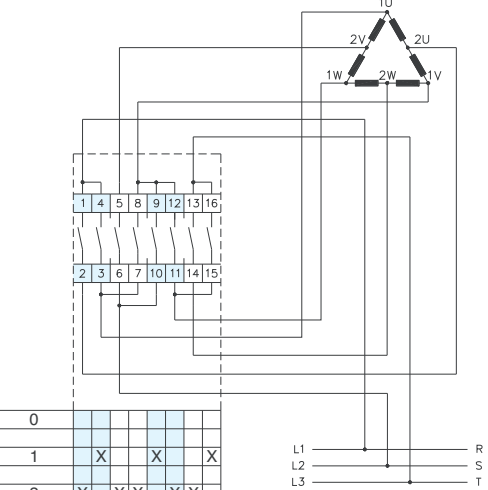
FUNZIONE FUNCTION	Mostrina Front plate	Schema Scheme	N°M elem.M N° ofM wafers	DIAGRAMMA / CONTACT CONFIGURATION																		
<p>Con "0" centrale (Δ - 0 - YY)</p> <p>With center "0" (Δ - 0 - YY)</p>		13	4	 <table border="1" data-bbox="991 786 1225 875"> <tr> <td>1</td> <td>X</td> <td></td> <td>X</td> <td></td> <td>X</td> </tr> <tr> <td>0</td> <td></td> <td></td> <td></td> <td></td> <td></td> </tr> <tr> <td>2</td> <td>X</td> <td>X</td> <td>X</td> <td>X</td> <td>X</td> </tr> </table>	1	X		X		X	0						2	X	X	X	X	X
1	X		X		X																	
0																						
2	X	X	X	X	X																	
<p>Versione standard (0 - Δ - YY)</p> <p>Standard version (0 - Δ - YY)</p>		19	4	 <table border="1" data-bbox="991 1435 1225 1525"> <tr> <td>0</td> <td></td> <td></td> <td></td> <td></td> <td></td> </tr> <tr> <td>1</td> <td>X</td> <td></td> <td>X</td> <td></td> <td>X</td> </tr> <tr> <td>2</td> <td>X</td> <td>X</td> <td>X</td> <td>X</td> <td>X</td> </tr> </table>	0						1	X		X		X	2	X	X	X	X	X
0																						
1	X		X		X																	
2	X	X	X	X	X																	

Schemi commutatori a camme serie GX e GN

Circuit schemes rotary cam switches GX and GN series

Commutatori di polarità con inversione di marcia (Dahlander)

Motor control switches (Dahlander) - pole changing with reversing

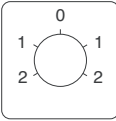
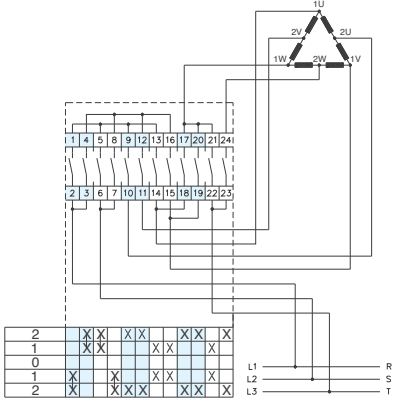
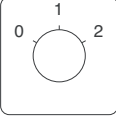
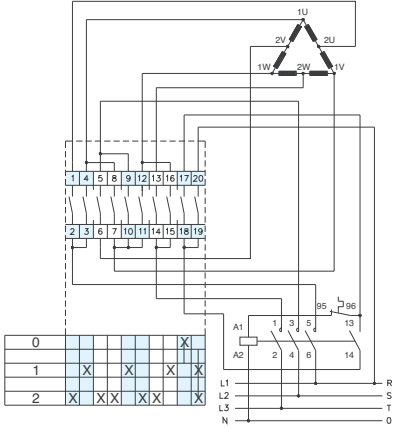
FUNZIONE FUNCTION	Mostrina Front plate	Schema Scheme	N°M elem.M N° ofM wafers	DIAGRAMMA / CONTACT CONFIGURATION
<p>Commutazione Sequenza: YY - Δ - 0 - Δ - YY Reversing Switching sequence: YY - Δ - 0 - Δ - YY</p>		20	6	
<p>Con contattore Sequenza: 0 - Δ - YY With contactor Switching sequence: 0 - Δ - YY</p>		32	5	

Commutatori per motori (avvolgimenti separati)

Motor control switches (separate windings)

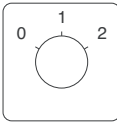
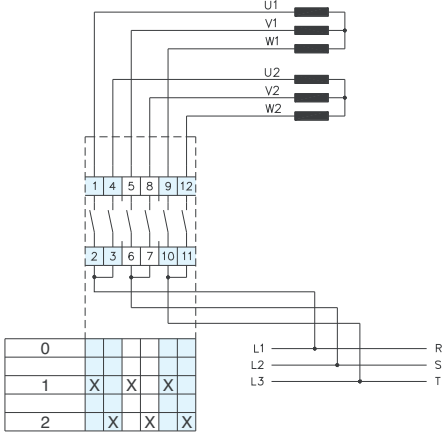
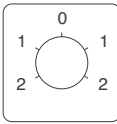
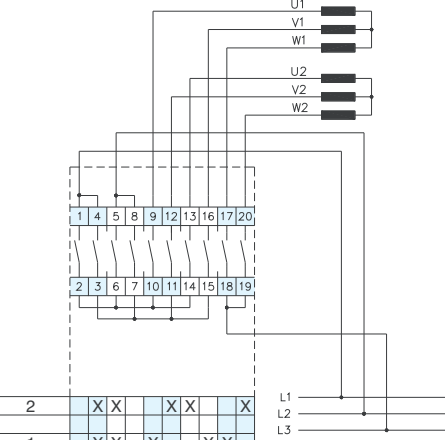
FUNZIONE FUNCTION	Mostrina Front plate	Schema Scheme	N°M elem.M N° ofM wafers	DIAGRAMMA / CONTACT CONFIGURATION																																																																																																				
<p>2 velocità, 2 avvolgimenti 2 speed, 2 winding</p>		22	3	 <table border="1" data-bbox="1021 739 1220 840"> <tr><td>0</td><td></td><td></td><td></td><td></td><td></td></tr> <tr><td>1</td><td>X</td><td></td><td>X</td><td>X</td><td>X</td></tr> <tr><td>2</td><td></td><td>X</td><td></td><td>X</td><td>X</td></tr> </table>	0						1	X		X	X	X	2		X		X	X																																																																																		
0																																																																																																								
1	X		X	X	X																																																																																																			
2		X		X	X																																																																																																			
<p>2 velocità, 2 commutazioni 2 avvolgimenti 2 speed, reversing, 2 windings</p>		23	5	 <table border="1" data-bbox="1021 1377 1276 1545"> <tr><td>2</td><td></td><td>X</td><td>X</td><td>X</td><td></td><td>X</td><td>X</td><td>X</td><td></td><td></td><td></td><td></td><td></td><td></td><td></td><td></td><td></td><td></td><td></td></tr> <tr><td>1</td><td></td><td>X</td><td>X</td><td></td><td>X</td><td></td><td></td><td>X</td><td>X</td><td></td><td></td><td></td><td>X</td><td>X</td><td></td><td></td><td></td><td></td><td></td></tr> <tr><td>0</td><td></td><td></td><td></td><td></td><td></td><td></td><td></td><td></td><td></td><td></td><td></td><td></td><td></td><td></td><td></td><td></td><td></td><td></td><td></td></tr> <tr><td>1</td><td>X</td><td></td><td></td><td>X</td><td>X</td><td></td><td></td><td>X</td><td>X</td><td></td><td></td><td></td><td>X</td><td>X</td><td></td><td></td><td></td><td></td><td></td></tr> <tr><td>2</td><td>X</td><td></td><td></td><td>X</td><td>X</td><td></td><td></td><td>X</td><td>X</td><td></td><td></td><td></td><td>X</td><td>X</td><td></td><td></td><td></td><td></td><td></td></tr> </table>	2		X	X	X		X	X	X												1		X	X		X			X	X				X	X						0																				1	X			X	X			X	X				X	X						2	X			X	X			X	X				X	X					
2		X	X	X		X	X	X																																																																																																
1		X	X		X			X	X				X	X																																																																																										
0																																																																																																								
1	X			X	X			X	X				X	X																																																																																										
2	X			X	X			X	X				X	X																																																																																										

Schemi commutatori a camme serie GX e GN

Circuit schemes rotary cam switches GX and GN series

Commutatori per motori (avvolgimenti separati)

Motor control switches (separate windings)

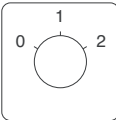
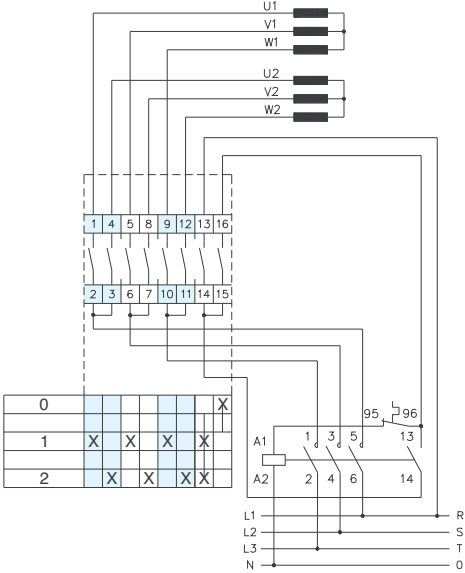
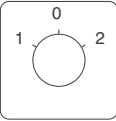
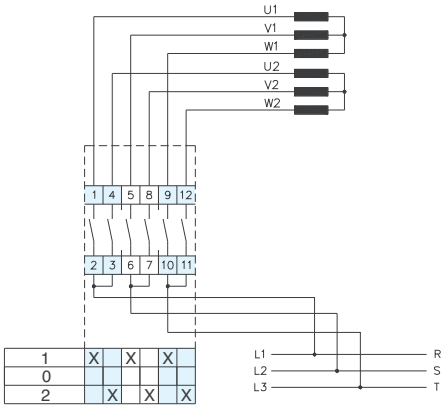
FUNZIONE FUNCTION	Mostrina Front plate	Schema Scheme	N°M elem.M N° ofM wafers	DIAGRAMMA / CONTACT CONFIGURATION
<p>2 velocità, 2 avvolgimenti con contattore 2 speed, 2 winding with contactor</p>		33	4	
<p>2 velocità, 2 avvolgimenti 2 speed, 2 winding</p>		53	3	

Commutatori di poli per motore a 3 velocità

Switches for 3-speed motor control

FUNZIONE FUNCTION	Mostrina Front plate	Schema Scheme	N°M elem.M N° of M waters	DIAGRAMMA / CONTACT CONFIGURATION																																				
<p>3 velocità, con contattore (ventilatore) (0-Y-Y-YY) 3 speed, with contactor (ventilator run) (0-Y-Y-YY)</p>		18	8	<p>The diagram shows a motor (M) with terminals 1U, 1V, 1W, 2U, 2V, 2W, 3U, 3V, 3W. The contact configuration table is as follows:</p> <table border="1"> <tr><td>0</td><td></td><td></td><td></td><td></td><td></td><td></td><td></td><td>X</td></tr> <tr><td>1</td><td>X</td><td>X</td><td></td><td></td><td>X</td><td>X</td><td>X</td><td>X</td></tr> <tr><td>2</td><td>X</td><td></td><td>X</td><td>X</td><td>X</td><td>X</td><td>X</td><td></td></tr> <tr><td>3</td><td>X</td><td>X</td><td>X</td><td>X</td><td>X</td><td>X</td><td>X</td><td>X</td></tr> </table>	0								X	1	X	X			X	X	X	X	2	X		X	X	X	X	X		3	X	X	X	X	X	X	X	X
0								X																																
1	X	X			X	X	X	X																																
2	X		X	X	X	X	X																																	
3	X	X	X	X	X	X	X	X																																
<p>3 velocità, 2 avvolgimenti (1. e 3. velocità Dahlander) (0 - Δ - Y - YY) 3 speed, 2 winding (1. and 3. speed Dahlander) (0 - Δ - Y - YY)</p>		34	6	<p>The diagram shows a motor with terminals 1U, 1V, 1W, 2U, 2V, 2W, 3U, 3V, 3W. The contact configuration table is as follows:</p> <table border="1"> <tr><td>0</td><td></td><td></td><td></td><td></td><td></td><td></td><td></td><td></td></tr> <tr><td>1</td><td></td><td></td><td>X</td><td>X</td><td></td><td></td><td>X</td><td></td></tr> <tr><td>2</td><td>X</td><td>X</td><td></td><td></td><td>X</td><td>X</td><td>X</td><td></td></tr> <tr><td>3</td><td>X</td><td>X</td><td>X</td><td>X</td><td>X</td><td>X</td><td>X</td><td></td></tr> </table>	0									1			X	X			X		2	X	X			X	X	X		3	X	X	X	X	X	X	X	
0																																								
1			X	X			X																																	
2	X	X			X	X	X																																	
3	X	X	X	X	X	X	X																																	

Schemi commutatori a camme serie GX e GN

Circuit schemes rotary cam switches GX and GN series

Commutatori di poli per motore a 3 velocità

Switches for 3-speed motor control

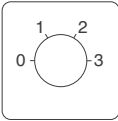
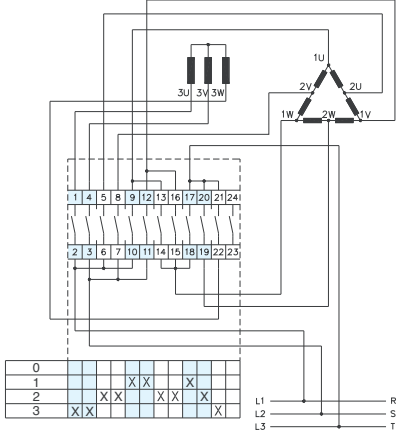
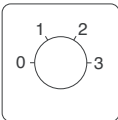
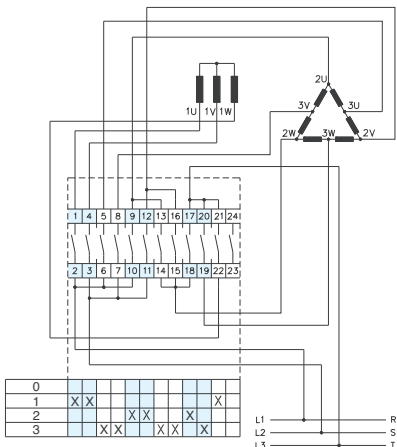
FUNZIONE FUNCTION	Mostrina Front plate	Schema Scheme	N°M elem. M N° of M wafers	DIAGRAMMA / CONTACT CONFIGURATION
<p>3 velocità, 2 avvolgimenti (1. e 2. velocità Dahlander) (0 - Δ-YY - Y)</p> <p>3 speed, 2 winding (1. and 2. speed Dahlander) (0 - Δ-YY - Y)</p>		35	6	
<p>3 velocità, 2 avvolgimenti (2. e 3. velocità Dahlander) (0 - Y - Δ-YY)</p> <p>3 speed, 2 winding (2. and 3. speed Dahlander) (0 - Y - Δ-YY)</p>		36	6	

Invertitori di marcia con fase ausiliaria

Start and run switches

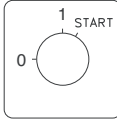
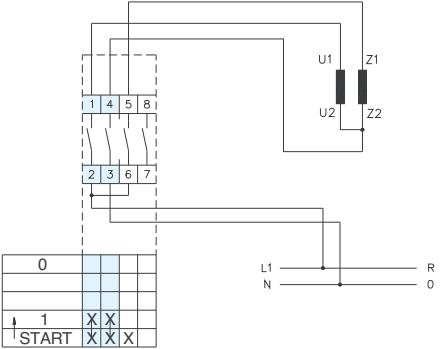
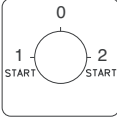
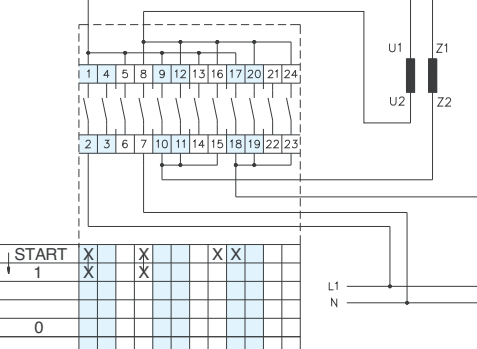
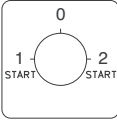
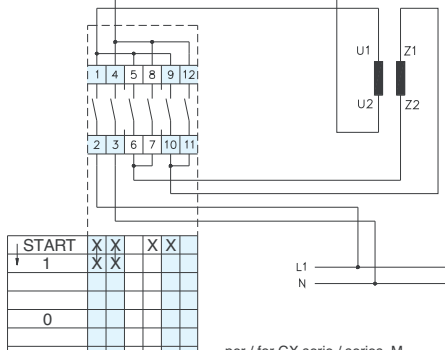
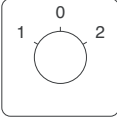
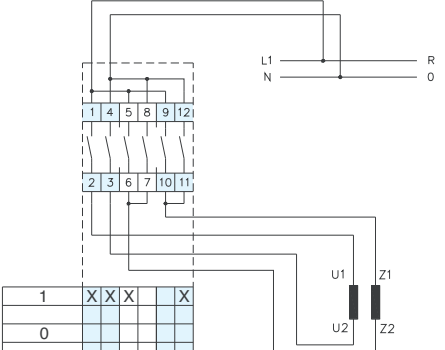
FUNZIONE FUNCTION	Mostrina Front plate	Schema Scheme	N°M elem.M N° ofM wafers	DIAGRAMMA / CONTACT CONFIGURATION
Versione standard Standard version		15	2	
Invertitore di marcia Reversing		16	6	 <p>per / for GN63</p>
		16	3	 <p>per / for GX serie / series, M GN12 - GN40, GN125</p>
Invertitore di marcia con avvolgimento di avviamento permanente Reversing permanent start winding		17	3	

Dimensioni (mm) / Dimensions [mm]

Commutatori a camme serie GX Rotary cam switches, GX series

Montaggio frontale / Front mounting

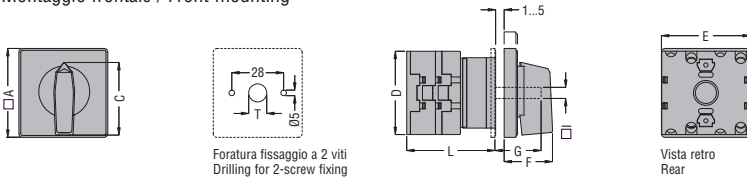

Foratura fissaggio a 2 viti
Drilling for 2-screw fixing

Vista retro
Rear

Tipo Type	Dimensioni / Dimensions								L [mm]					
	A	C	D	E	F	G	I	T	1 elem. 1 wafer	2 elem. 2 wafers	3 elem. 3 wafers	4 elem. 4 wafers	5 elem. 5 wafers	6 elem. 6 wafers
GX16 U	48	39.5	45	48	26.5	23.5	6	12	42.5	51	59.5	68	76.5	85
GX16 U25	48	31 [Ⓢ]	45	48	34	23.5	6	12	39.5	48	56.5	65	73.5	82
GX20 U	48	39.5	45	48	26.5	23.5	6	12	42.5	51	59.5	68	76.5	85
GX20 U25	48	31 [Ⓢ]	45	48	34	23.5	6	12	39.5	48	56.5	65	73.5	82
GX32 U	65	53	58	66	34.5	26	7	14	47.5	59.5	71.5	83.5	95.5	107.5
GX32 U25	65	45 [Ⓢ]	58	66	38	26	7	14	48	60	72	84	96	108
GX40 U	65	53	58	66	34.5	26	7	14	47.5	59.5	71.5	83.5	95.5	107.5
GX40 U25	65	45 [Ⓢ]	58	66	38	26	7	14	48	60	72	84	96	108

Ⓢ Manopola lucchettabile / Padlockable handle.

Montaggio blocco-porta esecuzione O / Door coupling O version

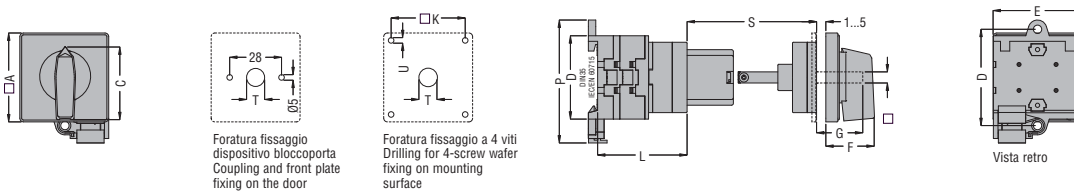

Foratura fissaggio dispositivo bloccoporta
Coupling and front plate fixing on the door

Foratura fissaggio a 4 viti
Drilling for 4-screw wafer fixing on mounting surface

Vista retro

Tipo Type	Dimensioni / Dimensions											L [mm]						
	A	C	D	E	F	G	K	N	O	P	S	T	1 elem. 1 wafer	2 elem. 2 wafers	3 elem. 3 wafers	4 elem. 4 wafers	5 elem. 5 wafers	6 elem. 6 wafers
GX16 O88	48	31 [Ⓢ]	45	48	34	23.5	36	6	52	66.5	45-55	12	40	48.5	57	65.5	74	82.5
GX20 O88	48	31 [Ⓢ]	45	48	34	23.5	36	6	52	66.5	45-55	12	40	48.5	57	65.5	74	82.5
GX32 O88	65	45 [Ⓢ]	58	66	38	26	48	7	68	78	45-55	14	48.7	60.7	72.7	84.7	96.7	108.7
GX40 O98	65	45 [Ⓢ]	58	66	38	26	48	7	68	78	45-55	14	48.7	60.7	72.7	84.7	96.7	108.7

Ⓢ Manopola lucchettabile / Padlockable handle.

Montaggio frontale Ø22mm / Front mounting Ø22mm

Montaggio frontale Ø22mm / Front mounting Ø22mm

Montaggio modulare / Modular mounting

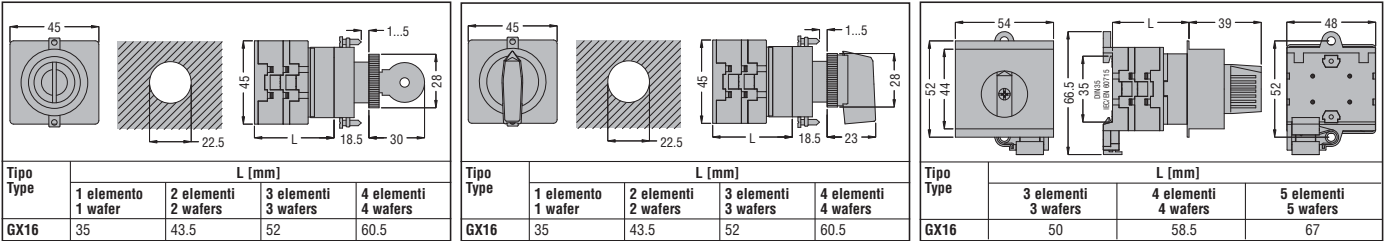

Tipo Type	L [mm]			
	1 elemento 1 wafer	2 elementi 2 wafers	3 elementi 3 wafers	4 elementi 4 wafers
GX16	35	43.5	52	60.5

Tipo Type	L [mm]			
	1 elemento 1 wafer	2 elementi 2 wafers	3 elementi 3 wafers	4 elementi 4 wafers
GX16	35	43.5	52	60.5

Tipo Type	L [mm]		
	3 elementi 3 wafers	4 elementi 4 wafers	5 elementi 5 wafers
GX16	50	58.5	67

Montaggio a scatto / Snap on mount

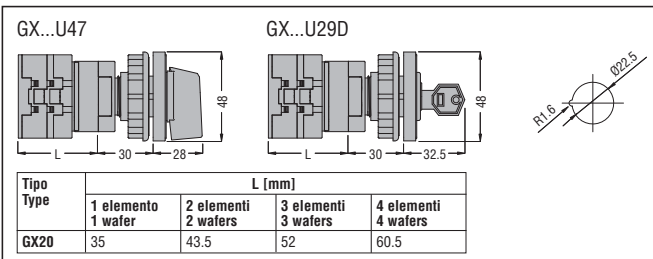

Tipo Type	L [mm]			
	1 elemento 1 wafer	2 elementi 2 wafers	3 elementi 3 wafers	4 elementi 4 wafers
GX20	35	43.5	52	60.5

Montaggio in cassetta / Mounting in enclosure

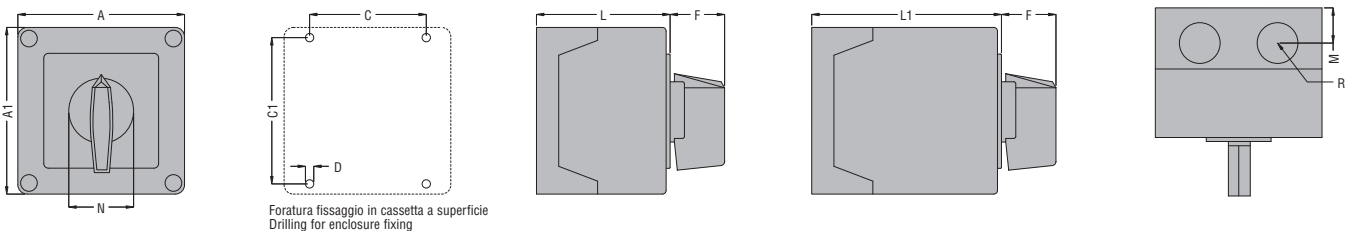

Foratura fissaggio in cassetta a superficie
Drilling for enclosure fixing

Tipo	Dimensioni cassetta	Numero elementi							Protezione	Pressacavi					
Type	Enclosure size	Number of wafers	L	L1	A	A1	C	C1	F	M	N	L	L1	Protection degree	Cable glands R
GX16	90x90	1-2	35	43.5	52	60.5								IP65	4xPG 16
GX20	90x90	1-2	35	43.5	52	60.5			25 [Ⓢ]	19	30	71.3	98.3	IP65	4xPG 16
GX32	110x110	1-2	35	43.5	52	60.5			32 [Ⓢ]	21	39.5	85.5	119.5	IP65	4xPG 21
GX40	110x110	1-2	35	43.5	52	60.5			32 [Ⓢ]	21	39.5	85.5	119.5	IP65	4xPG 21

Ⓢ 28 per tipo P25 con maniglia lucchettabile / 28 for ...P25 type.
Ⓢ 38,5 per tipo P25 con maniglia lucchettabile / 38.5 for ...P25 type.

Dimensioni (mm) / Dimensions [mm]

Commutatori a camme serie GN Rotary cam switches, GN series

Montaggio frontale / Front mounting

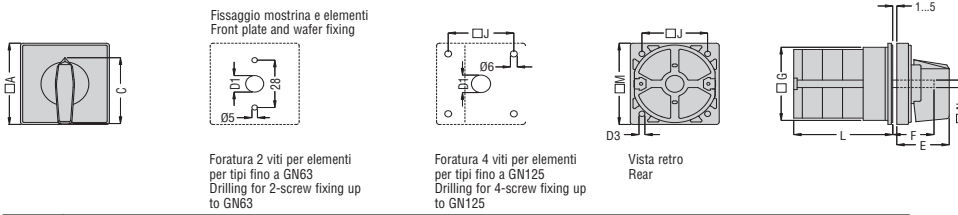

Tipo Type	Dimensioni / Dimensions										L					
	A	C	D1	D3	E	F	G	J	M	N	1 elem. 1 wafer	2 elem. 2 wafers	3 elem. 3 wafers	4 elem. 4 wafers	5 elem. 5 wafers	6 elem. 6 wafers
GN12	48	39.5	12	4.3	26.5	23.5	39	36	48	6	36.1	45.8	55.5	65.2	74.9	84.6
GN12⊕	65	53	14	4.3	34.5	26	58	48	65	7	36.6	46.3	56	65.7	75.4	85.1
GN20	48	39.5	12	4.3	26.5	23.5	39	36	48	6	36.1	45.8	55.5	65.2	74.9	84.6
GN20⊕	65	53	14	4.3	34.5	26	58	48	65	7	36.6	46.3	56	65.7	75.4	85.1
GN25	48	39.5	12	4.3	26.5	23.5	39	36	48	6	40.5	54.1	67.7	81.3	94.9	108.5
GN25⊕	65	53	14	4.3	34.5	26	58.5	48	65	7	41	54.6	68.2	81.8	95.4	109
GN32	65	53	14	4.3	34.5	26	58.5	48	65	7	46.5	61.6	76.7	91.8	106.9	122
GN40	65	53	14	4.3	34.5	26	58.5	48	65	7	46.5	61.6	76.7	91.8	106.9	122
GN63	65	53	14	4.3	34.5	26	62	48	65	7	50.3	68.4	86.5	104.6	122.7	140.8
GN125	90	70.5	16	5.3	41.5	28	84	68	90	9	67.3	96.4	125.5	154.6	183.7	212.8

① Dimensioni per esecuzioni U06 e U25
Dimensions for U06 and U25 versions

Montaggio blocco-porta / Door coupling O version

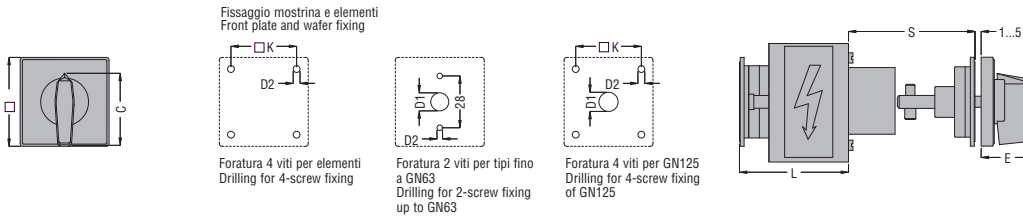

Tipo Type	Dimensioni / Dimensions								L			
	A	C	D1	D2	E	K	N	S	1 elem. 1 wafer	2 elem. 2 wafers	3 elem. 3 wafers	4 elem. 4 wafers
GN12-088	65	53	14	5	38.5⊕	48	28	45...55	37.58	47.1	56.7	66.3
GN20-088	65	53	14	5	38.5⊕	48	28	45...55	38.1	47.8	57.5	67.2
GN25-088	65	53	14	5	38.5⊕	48	28	45...55	42.5	56.1	65.7	83.2
GN32-0...	65	53⊕	14	5	34.5⊕	48	28	45...55	49.2	62.8	76.4	90
GN40-0...	65	53⊕	14	5	34.5⊕	48	28	45...55	45.9	59.5	73.1	86.7
GN63-0...	65	53⊕	14	6	34.5⊕	48	28	45...55	54.3	72.4	90.5	108.6
GN125-0...	90	70.5⊕	16	6	41.5⊕	68	36	45...55	74.8	103.9	133	162.1

- ⊕ 45 per tipi 088 e 098⊕
- 45 for 088 and 098 types⊕
- ⊕ 65 per tipo 099⊕
- 65 for 099 types⊕
- ⊕ 38,5 per tipi 088 e 098⊕
- 38.5 for 088 and 098 types⊕
- ⊕ 49 per tipo 099⊕
- 49 for 099 types⊕
- ⊕ Maniglia lucchettabile
- Padlockable handle.

Montaggio frontale Ø22mm / Front mounting Ø22mm

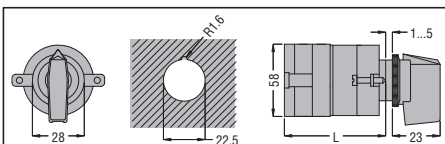

Tipo Type	L [mm]			
	1 elemento 1 wafer	2 elementi 2 wafers	3 elementi 3 wafers	4 elementi 4 wafers
GN12	41.5	51.1	60.7	70.3
GN20	42.1	51.8	61.5	71.2
GN25	46.5	60.1	73.7	87.3

Montaggio frontale Ø22mm / Front mounting Ø22mm

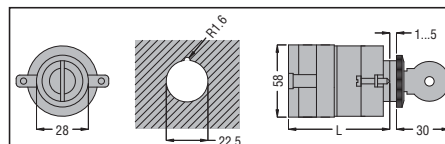

Tipo Type	L [mm]			
	1 elemento 1 wafer	2 elementi 2 wafers	3 elementi 3 wafers	4 elementi 4 wafers
GN12	41.5	51.1	60.7	70.3
GN20	42.1	51.8	61.5	71.2
GN25	46.5	60.1	73.7	87.3

Montaggio in cassetta / Mounting in enclosure

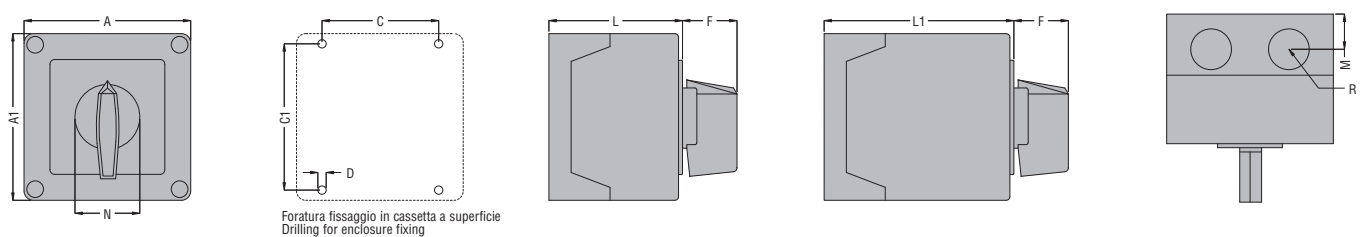

Tipo Type	Numero elementi Number of wafers	Dimensioni cassetta Enclosure size	Dimensioni										Protezione Protection degree	Pressacavi Cable glands R	
			A	A1	C	C1	D	F	M	N	L	L1			
GN12	1-2	3-4	75x75	75	75	64	50	4.5	19⊕	14	28	57.5	79.8	IP65	4xPG 13.5
GN20	1-2	3-4													
GN25	1	2-3													
GN20	1-3	4-6	90x90	90	90	63	79	4.5	25⊕	19	30	71.3	98.3	IP65	4xPG 16
GN25	1-2	3-4													
GN32	1-2	3-4													
GN40	1	2-3	110x110	110	110	98.4	83	4.5	32⊕	21	39.5	85.5	119.5	IP65	4xPG 21
GN32	1-3	4-5													
GN40	1-2	3-4													
GN63	1-2	3-4													

- ⊕ 28 per tipo P25 con maniglia lucchettabile.
- 28 for P25 type with padlockable handle.
- ⊕ 38,5 per tipo P25/P65 con maniglia lucchettabile.
- 38.5 for P25 type with padlockable handle.

GUIDA ALLA SCELTA

La scelta del commutatore e il suo dimensionamento devono fare riferimento, oltre che allo schema funzionale, al tipo di impiego previsto.

Le norme IEC forniscono una chiara e rapida classificazione delle varie categorie d'impiego riscontrabili più frequentemente:

- AC1: Inserzione e disinserzione di carichi resistivi ($\cos\varphi \geq 0,95$)
- AC21: Forni a resistenze
- AC3: Inserzione e disinserzione di motori
- AC23: Inserzione e disinserzione di carichi fortemente induttivi
- AC15: Comando di circuiti ausiliari, elettromagneti.

Per applicazioni in corrente continua i commutatori sono utilizzati per l'inserzione e la disinserzione di carichi minori o in circuiti di comando, quali:

- DC13: Comando di elettromagneti in corrente continua
- DC21: Manovra di carichi resistivi con sovraccarichi di modesta entità (DC21A è per utilizzo con operazioni frequenti).
- DC23: Manovra di carichi altamente induttivi (DC23A è per utilizzo con operazioni frequenti).

Ulteriori prescrizioni e raccomandazioni sull'utilizzo dei commutatori per l'equipaggiamento delle macchine elettriche sono dettate dalle normative IEC/EN 60204-1, e più precisamente quanto indicato alla voce impieghi.

IMPIEGHI

INTERRUTTORE GENERALE CON FUNZIONI DI EMERGENZA:

- manopola di colore rosso su sfondo giallo
- lucchettabile in posizione di aperto.

INTERRUTTORE DI EMERGENZA:

- manopola di colore rosso su sfondo giallo
- funzionamento indipendente e prevalente sulle altre funzioni
- la portata nominale deve tener conto della somma delle correnti nominali di esercizio di tutte le apparecchiature
- potere d'interruzione pari alla corrente motore a rotore bloccato più la corrente totale assorbita da altri carichi presenti.

INTERRUTTORE GENERALE CON FUNZIONI DI SEZIONAMENTO:

- utilizzato per separare l'apparecchiatura dalla rete di alimentazione
- distanza in aria dei contatti rispondente alla norma IEC/EN 60947-3
- possibilità di blocco con lucchetto in posizione di aperto
- dimensionamento per interruzione di correnti previste dalle categorie AC1 e AC21.

TIPO		GX16	GX20	GX32	GX40	GN12	GN20	GN25	GN32	GN40	GN63	GN125	
Tensione nominale di isolamento ^① Ui IEC/EN UL/CSA	V	690	690	690	690	690	690	690	690	690	690	690	
	V	600	600	600	600	600	600	600	600	600	600	600	
Tensione nominale di tenuta ad impulso ^① Uimp IEC/EN 60947-3	kV	6	6	6	6	6	6	6	6	6	6	8	
Corrente termica nominale Ith IEC/EN UL/CSA (general purpose)	A	16	20	32	40	16	20	25	32	40	63	125	
	A	12	15	32	40	15	20	30	40	50	60	130	
Tensione nominale di impiego (interruttore sezionatore) ^①	V	440	440	440	440	480	480	480	480	480	480	690	
Tensione nominale di tenuta a impulso (interruttore sezionatore)	kV	4	4	4	4	4	4	4	4	4	4	6	
Max. calibro fusibili per protezione da corto circuito In (gG)	10kA	A	20	20	40	40	16	20	25	32	40	63	125
	25kA	A	16	16	35	35	10	16	25	32	40	63	100
	50kA	A	-	-	32	35	-	-	-	32	40	63	100
	63kA	A	-	-	-	35	-	-	-	-	40	63	100
Corrente nominale di breve durata ammissibile Icw	1sec	A	250	250	800	800	200	250	400	800	1000	1200	2100
Correnti nominali di esercizio Ie AC1/AC21A (IEC/EN) AC15 (IEC/EN)	110V	A	16	20	32	40	16	20	25	32	40	63	125
	220...230V	A	10	10	25	25	10	10	16	25	25	32	40
	380...400V	A	8	8	20	22	8	8	12	20	22	25	28
	500...690V	A	4	6	10	12	4	6	8	10	12	15	15
	660...690V	A	3	3,7	5,5	7,5	1,5	1,5	2	2	2	4	5
Interruttori per motori in categorie di impiego in corrente alternata AC3 (IEC/EN) 3 fasi 1 fase (2 poli) AC23A (IEC/EN) 3 fasi 1 fase (2 poli)	220...230V	kW	3,5	3,7	7,5	7,5	2,5	3	5,5	7,5	8	11	18,5
	380...440V	kW	4,5	5,5	11	15	4	5,5	7,5	11	15	18,5	37
	500...690V	kW	5,5	5,5	11	15	5,5	5,5	7,5	11	15	18,5	33
	110V	kW	0,55	0,75	1,8	2,2	0,8	0,8	1,5	2,2	3	3,7	5
	220...230V	kW	1,5	1,8	3,5	4,4	1,5	2,2	3	4	6,5	6,5	11
	380...440V	kW	2,2	3	5,5	7	2,2	3	5,5	6,5	8	11,5	15
	220...230V	kW	3,7	4	8	9	3	5	6,5	8	8	12,5	30
	380...440V	kW	6,5	7,5	15	18,5	5,5	7,5	11	15	18,5	30	45
	500...690V	kW	7,5	7,5	15	15	7,5	7,5	11	18,5	22	30	37
110V	kW	0,75	0,75	2,2	3	0,8	0,8	1,5	2,2	3	3,7	5	
220...230V	kW	1,8	2,2	3,5	5,2	1,7	2,5	3,7	4	6	7,5	11	
380...440V	kW	3	3,5	6	7,5	3	3,7	5,5	7,5	11	12,5	15	

^① Validi per sistemi con neutro e terra, categoria di sovratensione III, grado di inquinamento 3.

Caratteristiche tecniche

Commutatori a camme serie GX e GN

TIPO			GX16	GX20	GX32	GX40	GN12	GN20	GN25	GN32	GN40	GN63	GN125	
Interruttori per motori Comando diretto (UL/CSA-DOL) 3 fasi	120V	HP	1,5	1,5	3	5	-	-	-	-	-	-	-	
	230V	HP	3	3	7,5	10	3	3	-	-	-	-	-	
	480V	HP	5	5	15	15	-	-	10	15	20	25	50	
	600V	HP	5	5	15	15	-	-	-	-	-	-	40	
	1 fase (2 poli)	120V	HP	0,75	0,75	1,5	2	-	-	-	-	-	-	
	230V	HP	1	1,5	3	5	-	-	-	-	-	-	-	
Interruttori per motori in categoria di impiego in corrente continua DC21A	48V	A	16	20	32	40	12	20	25	32	40	63	125	
	60V	A	16	20	32	40	12	20	25	32	40	50	80	
	le	110V	A	4	4	5	6	4	4	4	6	6	8	10
	220V	A	0,5	0,6	0,8	0,8	0,6	0,6	0,7	0,9	0,9	1	1,2	
	440V	A	0,25	0,25	0,25	0,25	0,25	0,25	-	-	-	-	-	
DC23A	24V	A	16(1)	20(1)	32(1)	40(1)	10(1)	20(1)	25(1)	32(1)	40(1)	50(1)	125(1)	
	48V	A	16(2)	20(2)	32(2)	40(1)	10(2)	20(2)	25(2)	32(2)	40(2)	50(2)	125(2)	
	le	60V	A	16(3)	20(3)	32(3)	40(3)	10(3)	20(3)	25(3)	32(3)	40(3)	50(3)	125(3)
Collegare in serie il n° dei contatti indicati tra parentesi	110V	A	10(3)	10(3)	15(3)	20(3)	5(3)	10(3)	12(3)	15(3)	20(3)	25(3)	50(3)	
	220V	A	7(4)	8(4)	12(4)	12(4)	5(4)	8(4)	10(4)	12(4)	12(4)	15(4)	20(4)	
DC13	24V	A	16	20	32	40	12	20	25	32	40	63	125	
	48V	A	14	16	25	32	10	16	20	25	32	40	100	
	60V	A	12	12	16	16	8	12	16	16	16	28	50	
	le	110V	A	0,8	1	3	3	1	1	1,5	3	3	3,3	4
	220V	A	0,3	0,4	0,5	0,5	0,4	0,4	0,4	0,5	-	-	-	
440V	A	0,15	0,15	0,15	0,15	0,15	0,15	-	-	-	-	-		
Potenza dissipata	w/polo		0,6	0,6	1,6	1,6	0,8	0,8	1,1	1,5	2,0	3,4	6,3	
Durata meccanica	cicli	5×10^5	5×10^6	5×10^6	3×10^6	5×10^6	5×10^6	5×10^6	5×10^6	5×10^6	5×10^6	1×10^6		
Vite del morsetto	M	3	3	4	4	3	3	3,5	4	4	4	5	2x5	
Coppia di serraggio	max	Nm	0,5	0,8	1,2	1,2	0,5	0,5	0,8	1,2	1,2	2	2	
Sezione conduttore	max. r/f	2xmm ²	2,5/2,5	2,5/2,5	10/6	10/6	2,5/2,5	2,5/2,5	4/4	6/4	10/6	16/10	50/50	
		2xAWG	14/14	14/14	8/10	8/10	12/14	12/14	10/12	8/10	8/10	6/8	1/0 / 1/0	
r: rigido	min. r/f	2xmm ²	0,5/0,5	0,5/0,5	1,5/1,5	1,5/1,5	0,5/0,5	0,5/0,5	0,5/0,5	1,5/1,5	1,5/1,5	2,5/2,5	2,5/2,5	
f: flessibile		2xAWG	20/20	20/20	16/16	16/16	20/20	20/20	20/20	16/16	16/16	14/14	14/14	
CONDIZIONI AMBIENTALI														
Temperatura di impiego	°C												-25...+55	
Temperatura di stoccaggio	°C												-40...+70	

SELECTION GUIDE

The choice of a rotary cam switch and the relative type are based on the functional diagram and the type of application as well.

IEC standards provide a comprehensible and quick classification of the most frequent utilisation categories:

- AC1: Connection and disconnection of non-inductive or slightly inductive loads ($\cos\varphi \geq 0.95$)
- AC21: Resistance furnaces
- AC3: Starting and switching off motors during running
- AC23A: Switching of motor loads or other highly inductive loads
- AC15: Control of electromagnetic loads

For DC applications, the rotary cam switches are used for the switching of minor loads or in control circuits, such as:

- DC13: Control of electromagnets
- DC21A: Switching of resistive loads
- DC23: Switching of highly inductive loads

Other prescriptions and recommendations concerning the use of cam switches as auxiliary equipment of electrical machines are given in IEC/EN 60204-1 standards and specifically as given under utilisation.

UTILISATION

MAIN SUPPLY DISCONNECTING SWITCH WITH EMERGENCY-STOP OPERATION:

- Red operating handle with yellow background
- Lockable in open position (OFF).

EMERGENCY-STOP SWITCH

- Red operating handle with yellow background
- Independent operation and the breaking of the load circuit of switching devices before the opening of its main contacts
- Rated capacity is to be sufficient in order to break the sum of the rated operating currents of all the connected equipment
- Breaking capacity equal to the current of the largest motor when stalled (locked rotor) together with the total of the normal running currents of the other motors or loads.

MAIN SUPPLY DISCONNECTING SWITCH

- Used to disconnect all live electrical equipment from the power supply circuit
- Contact clearance distance is to comply with IEC/EN 60947-3 standards
- Provided with a means in order to be locked in the OFF position
- Selection of current breaking according to IEC AC1 and AC21 utilisation categories.

TYPE		GX16	GX20	GX32	GX40	GN12	GN20	GN25	GN32	GN40	GN63	GN125	
Rated insulation voltage ^① Ui IEC/EN UL/CSA	V	690	690	690	690	690	690	690	690	690	690	690	
	V	600	600	600	600	600	600	600	600	600	600	600	
Rated impulse withstand voltage ^① Uimp IEC/EN 60947-3	kV	6	6	6	6	6	6	6	6	6	6	8	
Conventional free air thermal current Ith IEC/EN UL/CSA (general purpose use)	A	16	20	32	40	16	20	25	32	40	63	125	
	A	12	15	32	40	15	20	30	40	50	60	130	
Rated operating voltage (switch disconnect) ^①	V	440	440	440	440	480	480	480	480	480	480	690	
Operational impulse voltage (switch disconnect)	kV	4	4	4	4	4	4	4	4	4	4	6	
Maximum fuse size for short-circuit protection In (gG)	10kA	A	20	40	40	16	20	25	32	40	63	125	
	25kA	A	16	35	35	10	16	25	32	40	63	100	
	50kA	A	-	32	35	-	-	-	32	40	63	100	
	63kA	A	-	-	35	-	-	-	-	40	63	100	
Short-time withstand current Icw	1sec	A	250	800	800	200	250	400	800	1000	1600	2100	
Rated operational current Ie AC1/AC21A (IEC/EN) AC15 (IEC/EN)	A	16	20	32	40	16	20	25	32	40	63	125	
	110V	A	10	10	25	25	10	10	16	25	25	32	40
	220...230V	A	8	8	20	22	8	8	12	20	22	25	28
	380...440V	A	4	6	10	12	4	6	8	10	12	15	15
	660...690V	A	3	3.7	5.5	7.5	1.5	1.5	2	2	2	4	5
Motor power for switches in AC utilisation categories AC3 (IEC/EN) 3 phases 1 phase (2 poles)	220...230V	kW	3.5	3.7	7.5	7.5	2.5	3	5.5	7.5	8	11	18.5
	380...440V	kW	4.5	5.5	11	15	4	5.5	7.5	11	15	18.5	37
	500...690V	kW	5.5	5.5	11	15	5.5	5.5	7.5	11	15	18.5	33
	110V	kW	0.55	0.75	1.8	2.2	0.8	0.8	1.5	2.2	3	3.7	5
	220...230V	kW	1.5	1.8	3.5	4.4	1.5	2.2	3	4	6.5	6.5	11
	380...440V	kW	2.2	3	5.5	7	2.2	3	5.5	6.5	8	11.5	15
	220...230V	kW	3.7	4	8	9	3	5	6.5	8	8	12.5	30
	380...440V	kW	6.5	7.5	15	18.5	5.5	7.5	11	15	18.5	30	45
	500...690V	kW	7.5	7.5	15	15	7.5	7.5	11	18.5	22	30	37
AC23A (IEC/EN) 3 phases 1 phase (2 poles)	110V	kW	0.75	0.75	2.2	3	0.8	0.8	1.5	2.2	3	3.7	5
	220...230V	kW	1.8	2.2	3.5	5.2	1.7	2.5	3.7	4	6	7.5	11
	380...440V	kW	3	3.5	6	7.5	3	3.7	5.5	7.5	11	12.5	15

① Valid for systems with earthed neutral, overvoltage category III, pollution degree 3.

Technical characteristics

Rotary cam switches

TYPE			GX16	GX20	GX32	GX40	GN12	GN20	GN25	GN32	GN40	GN63	GN125
Motor power for direct-on-line control (UL/CSA-DOL) 3 phases	120V	HP	1.5	1.5	3	5	–	–	–	–	–	–	–
	230V	HP	3	3	7.5	10	3	3	–	–	–	–	–
	480V	HP	5	5	15	15	–	–	10	15	20	25	50
	600V	HP	5	5	15	15	–	–	–	–	–	–	40
1 phase (2 poles)	120V	HP	0.75	0.75	1.5	2	–	–	–	–	–	–	–
	230V	HP	1	1.5	3	5	–	–	–	–	–	–	–
Motor power for switches in DC utilisation categories													
1 contact DC21A	48V	A	16	20	32	40	12	20	25	32	40	63	125
	60V	A	16	20	32	40	12	20	25	32	40	50	80
	le 110V	A	4	4	5	6	4	4	4	6	6	8	10
	220V	A	0.5	0.6	0.8	0.8	0.6	0.6	0.7	0.9	0.9	1	1.2
	440V	A	0.25	0.25	0.25	0.25	0.25	0.25	–	–	–	–	–
DC23A	24V	A	16(1)	20(1)	32(1)	40(1)	10(1)	20(1)	25(1)	32(1)	40(1)	50(1)	125(1)
	48V	A	16(2)	20(2)	32(2)	40(1)	10(2)	20(2)	25(2)	32(2)	40(2)	50(2)	125(2)
	le 60V	A	16(3)	20(3)	32(3)	40(3)	10(3)	20(3)	25(3)	32(3)	40(3)	50(3)	125(3)
No. of contacts connected in series are indicated in brackets	110V	A	10(3)	10(3)	15(3)	20(3)	5(3)	10(3)	12(3)	15(3)	20(3)	25(3)	50(3)
	220V	A	7(4)	8(4)	12(4)	12(4)	5(4)	8(4)	10(4)	12(4)	12(4)	15(4)	20(4)
DC13	24V	A	16	20	32	40	12	20	25	32	40	63	125
	48V	A	14	16	25	32	10	16	20	25	32	40	100
	60V	A	12	12	16	16	8	12	16	16	16	28	50
	le 110V	A	0.8	1	3	3	1	1	1.5	3	3	3.3	4
	220V	A	0.3	0.4	0.5	0.5	0.4	0.4	0.4	0.5	–	–	–
440V	A	0.15	0.15	0.15	0.15	0.15	0.15	–	–	–	–	–	
Power dissipation	W/pole		0.6	0.6	1.6	1.6	0.8	0.8	1.1	1.5	2.0	3.4	6.3
Mechanical life	cycles		5x10 ⁶	5x10 ⁶	5x10 ⁶	5x10 ⁶	3x10 ⁶	5x10 ⁶	5x10 ⁶	5x10 ⁶	5x10 ⁶	5x10 ⁶	1x10 ⁶
Terminal screw	M		3	3	4	4	3	3	3.5	4	4	5	2x5
Tightening torque	max Nm		0.5	0.8	1.2	1.2	0.5	0.5	0.8	1.2	1.2	2	2
Conductor cross section	max. r/f	2 mm ²	2.5/2.5	2.5/2.5	10/6	10/6	2.5/2.5	2.5/2.5	4/4	6/4	10/6	16/10	50/50
		2 AWG	14/14	14/14	8/10	8/10	14/16	12/14	10/12	8/10	8/10	6/8	1/0 / 1/0
r: rigid/solid f: flexible/stranded	min. r/f	2 mm ²	0.5/0.5	0.5/0.5	1.5/1.5	1.5/1.5	0.5/0.5	0.5/0.5	0.5/0.5	1.5/1.5	1.5/1.5	2.5/2.5	2.5/2.5
		2 AWG	20/20	20/20	16/16	16/16	20/20	20/20	20/20	16/16	16/16	14/14	14/14
AMBIENT CONDITIONS													
Operating temperature	°C		–25...+55										
Storage temperature	°C		–40...+70										

Indice schemi

Index circuit schemes

Schema Schemes	Pagina Page	Schema Schemes	Pagina Page	Schema Schemes	Pagina Page	Schema Schemes	Pagina Page
1	8	52	9	103	12	154	10
2	8	53	9	104	13	155	11
3	8	53	41	105	13	156	14
4	8	54	10	106	13	157	14
5	7	55	10	107	14	158	14
6	7	56	10	108	14	159	10
7	7	57	7	109	14	160	14
8	7	58	26	110	15	161	14
9	7	60	24	111	15	162	10
10	6	61	28	112	16	163	14
11	33	62	10	113	17	164	14
12	35	63	7	114	18	165	17
13	38	64	29	115	19	166	33
14	33	65	30	116	20	171	9
15	44	66	24	117	12	172	9
16	44	67	25	118	12	173	9
17	45	68	25	119	12	174	9
18	42	69	10	120	13	175	14
19	38	70	10	121	13	176	14
20	39	71	10	122	13	177	14
21	35	72	10	123	14	178	14
22	40	73	10	124	14	179	15
23	40	74	10	125	14	182	9
24	32	75	9	126	15	183	9
25	34	76	9	127	15	201	8
26	34	77	9	128	16	202	8
27	34	78	9	129	17	203	8
28	36	79	9	130	18	204	31
29	36	80	9	131	19	205	31
30	35	81	9	132	20	206	31
31	37	82	10	133	12	207	31
32	39	83	11	134	12	208	31
33	41	84	11	135	14	209	31
34	42	85	11	136	14	210	32
35	43	86	10	137	14	251	21
36	43	87	11	138	15	252	21
37	6	88	11	139	15	253	22
38	6	89	11	140	16	254	21
39	6	90	6	141	10	255	21
40	6	91	6	142	11	256	22
41	6	92	6	143	11	257	22
42	6	93	10	144	11	258	23
43	10	94	11	145	14	259	23
44	10	95	11	146	14	260	23
45	8	96	11	147	14	270	7
46	8	97	27	148	15	271	7
47	8	98	26	149	10	275	7
48	8	99	6	150	11	276	7
49	37	100	6	151	14	277	7
50	45	101	12	152	14	278	7
51	9	102	12	153	14		



ENERGY AND AUTOMATION

www.LovatoElectric.com

LOVATO ELECTRIC S.P. A.

via Don E. Mazza, 12
24020 Gorle (Bergamo) Italia

Tel +39 035 4282111
Fax +39 035 4282200
info@LovatoElectric.com

Seguici su

