

CATALOGUE

2016-Q1

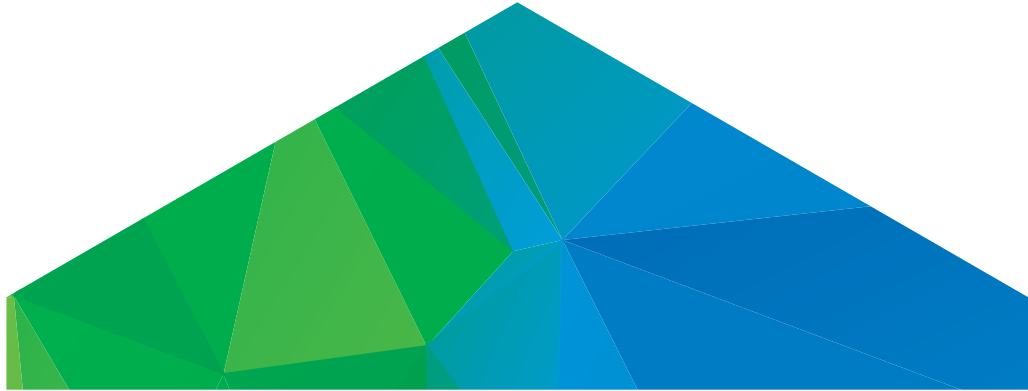

THE **NEXT** STEP TOWARDS *Sustainability*

V-TAC[®]
INNOVATIVE LED LIGHTING

CERTIFICATES

CE/EMC



CE/RoHS



CE/LVD



the **LIA**
MEMBER

TABLE OF CONTENTS

01

LED Spot Lights

15

LED Bulbs

53

LED Par/AR111 Bulbs

61

LED Tubes

77

LED Panels

105

LED Flood Lights

127

LED Highbays

131

LED Street Lights

137

LED Strip Lights

155

LED Track Lights

163

LED Downlights

171

LED Dome Lights

177

Motion sensors

182

LED Outdoor Lights

185

LED Table Lamps



LED SPOT LIGHTS

Introducing sustainable & energy efficient substitute for the power consuming 35W and 50W Halogen Spotlights , An extensive range of LED SPOTLIGHTS (1.2W - 7W)

PRODUCT FEATURES

- Lasts 20 times longer than Standard Bulbs
- Uses 80% less energy than Standard Bulbs
- Excellent Heat Radiation Efficiency
- Customized exterior for stronger body
- Choice of beam angle from 38° to 120°
- Non - Flickering
- Premium Quality Power Driver
- Broad Range of holders like GU10, MR16, JCDR, G9 and G4
- Wide Voltage Range from AC: 180 - 240 V , 50/60 Hz & 12 v options
- Dimmable & Non Dimmable options

APPLICATIONS

- Perfect choice for Hotels, Bars, Commercial & Residential Lighting and Exhibition Stands





7W

VT-2666

1657 3000K Warmwhite
 1658 4500K Daywhite
 1659 6000K White



7W

VT-2886D

1666 3000K Warmwhite
 1667 4500K Daywhite
 1668 6000K White





7W

VT-2778

1672 3000K Warmwhite
 1673 4500K Daywhite
 1674 6000K White



Model No.	VT-2666	VT-2886D	VT-2778
Watts	7W	7W	7W
EQ. Watts	75W	75W	45W
Voltage/Frequency	AC:220-240V,50Hz	AC:220-240V,50Hz	AC: 220-240V,50Hz
Luminous Flux	550lm	550lm	500lm
LED Type	SMD	SMD	SMD
CRI	>80	>80	> 80
PF	>0.5	>0.5	> 0.5
Beam Angle	38°D	38°D	110°D
Base	GU10	GU10	GU10
Body Type	Plastic	Plastic	Plastic
Dimension	50mm x 57mm 	50mm x 57mm 	50mm x 57mm 
EAN Code 3000K	3800157601641	3800157602075	3800157602136
EAN Code 4500K	3800157601658	3800157602082	3800157602143
EAN Code 6000K	3800157601665	3800157602099	3800157602150



5W
VT-1975

1685 3000K Warmwhite
1686 4500K Daywhite
1687 6000K White

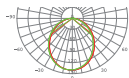

Model No.	VT-1975
Watts	5W
EQ. Watts	40W
Voltage/Frequency	AC:220-240V,50Hz
Luminous Flux	320lm
LED Type	SMD
CRI	>80
PF	>0.5
Beam Angle	110°D
Base	GU10
Body Type	Plastic
Dimension	50mm x 58mm



EAN Code 3000K	3800157606240
EAN Code 4500K	3800157606257
EAN Code 6000K	3800157606264





7W
VT-2779

1682 3000K Warmwhite
 1683 4500K Daywhite
 1684 6000K White



7W
VT-2887D

1669 3000K Warmwhite
 1670 4500K Daywhite
 1671 6000K White



7W
VT-1977

1688 3000K Warmwhite
 1689 4500K Daywhite
 1690 6000K White



Model No.	VT-2779	VT-2887D	VT-1977
Watts	7W	7W	7W
EQ. Watts	45W	45W	45W
Voltage/Frequency	AC:220-240V,50Hz	AC:220-240V,50Hz	AC/DC: 12V,50Hz
Luminous Flux	500lm	500lm	500lm
LED Type	SMD	SMD	SMD
CRI	>80	>80	>80
PF	>0.5	>0.5	>0.5
Beam Angle	110°D	110°D	110°D
Base	GU10	GU10	MR16
Body Type	Plastic	Plastic	Plastic
Dimension	50mm x 57mm	50mm x 57mm	50mm x 50mm
			
EAN Code 3000K	3800157605359	3800157602105	3800157606950
EAN Code 4500K	3800157605366	3800157602112	3800157606967
EAN Code 6000K	3800157605373	3800157602129	3800157606974

2W

VT-1992

1679 3000K WarmWhite
1680 4500K DayWhite
1681 6000K White





7W

VT-1967

1663 3000K Warmwhite
1664 4500K Daywhite
1665 6000K White



Model No.	VT-1992	VT-1967
Watts	2W	7W
EQ. Watts	15W	50W
Voltage/Frequency	AC/DC:12V,50Hz	AC/DC: 12V,50Hz
Luminous Flux	140lm	550lm
LED Type	SMD	SMD
CRI	>80	>80
PF	/	>0.5
Beam Angle	38'D	38'D
Base	MR11	MR16.12V/GU5.3
Body Type	Plastic	Plastic
Dimension	35mm x 39mm	50mm x 50mm
		
EAN Code 3000K	3800157605038	3800157602044
EAN Code 4500K	3800157605045	3800157602051
EAN Code 6000K	3800157605052	3800157602068



Available In
Blister Pack
3 pcs

2W
VT-1846

4203 3000K Warmwhite
4204 4500K Daywhite
4205 6000K White



Available In
Blister Pack
3 pcs

2.5W
VT-1946

4358 3000K Warmwhite
4359 4500K Daywhite
4360 6000K White

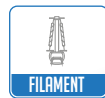

Available In
Blister Pack
3 pcs

3W
VT-1943

4436 3000K Warmwhite
N/A 4500K Daywhite
N/A 6000K White



Available In
Blister Pack
3 pcs

4W
VT-1849

4295 3000K Warmwhite
4296 4500K Daywhite
4297 6000K White

Model No.	VT-1846	VT-1946	VT-1943	VT-1849
Watts	2W	2.5W	3W	4W
EQ. Watts	20W	25W	25W	30W
Voltage/Frequency	AC: 220-240V,50/60Hz	AC: 220-240V,50Hz	AC:220-240V,50Hz	AC: 220-240V,50/60Hz
Luminous Flux	160lm	200lm	300lm	320lm
LED Type	SMD	SMD	Filament	SMD
CRI	> 80	>80	>80	> 80
PF	/	>0.4	>0.4	>0.4
Beam Angle	120'D	300'D	300'D	150'D
Base	G9	G9	G9	G9
Body Type	Plastic	Plastic	Plastic	Plastic
Dimension	18mm x 60mm	16mm x 48mm	16mmx 60 mm	23mm x 65mm
EAN Code 3000K	3800230625359	3800157602716	3800157607025	3800230628961
EAN Code 4500K	3800230625366	3800157602723	N/A	3800230628978
EAN Code 6000K	3800230625373	3800157602730	N/A	3800230628985



Available In
Blister Pack
3 pcs





1.2W 4222 3000K Warmwhite
VT-1863 4287 4500K Daywhite
4240 6000K White



Available In
Blister Pack
3 pcs

1.5W 4391 3000K Warmwhite
VT-1942 4392 4500K Daywhite
4393 6000K White



Model No.	VT-1863	VT-1942
Watts	1.2W	1.5W
EQ. Watts	5W	20W
Voltage/Frequency	AC/DC: 12V,50Hz	AC/DC: 12V,50Hz
Luminous Flux	80lm	180lm
LED Type	CREE	SMD
CRI	> 80	>80
PF	> 0.5	>0.5
Beam Angle	300°D	300°D
Base	G4	G4
Body Type	Plastic	Plastic
Dimension	10mm x 23mm 	10mm x 40mm 
EAN Code 3000K	3800230625502	3800157604154
EAN Code 4500K	3800230628701	3800157604161
EAN Code 6000K	3800230626783	3800157604178



7W
VT-1969

4437 3000K Warmwhite
 4438 4500K Daywhite
 4439 6000K White



Model No.

VT-1969

Watts

7W

EQ. Watts

45W

Voltage/Frequency

AC:220-240V,50Hz

Luminous Flux

550lm

Commercial Type

Gx53

LED Type

SMD

CRI

> 80

PF

> 0.5

Beam Angle

110°D

Base

Recessed Gx53

Body Type

Thermoplastic

Dimension

75 x 23.5 mm

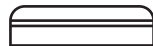

EAN Code 3000K

[3800157607032](#)

EAN Code 4500K

[3800157607049](#)

EAN Code 6000K

[3800157607056](#)



Accessories LED Spotlight Fitting



Model No	VT-778
SKU Code	3584
Base	GU10
Material	Ferrum
Shape	Round
Color of fixture	White
Dimension	Φ80 x 30mm
Cutting Size	Φ65mm
EAN Code	3800157607131

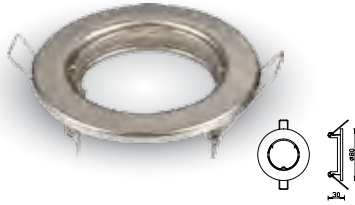

Model No	VT-778
SKU Code	3585
Base	GU10
Material	Ferrum
Shape	Round
Color of fixture	Satin Nickel
Dimension	Φ80 x 30mm
Cutting Size	Φ65mm
EAN Code	3800157607148

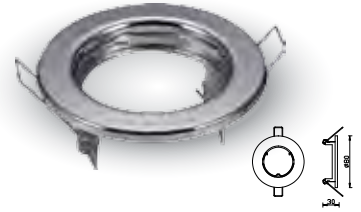

Model No	VT-778
SKU Code	3586
Base	GU10
Material	Ferrum
Shape	Round
Color of fixture	Chrome
Dimension	Φ80 x 30mm
Cutting Size	Φ65mm
EAN Code	3800157607155



Model No	VT-779
SKU Code	3587
Base	GU10
Material	Zinc Alloy
Shape	Round
Color of fixture	White
Dimension	Φ82 x 25mm
Cutting Size	Φ74mm
EAN Code	3800157607162



Model No	VT-779
SKU Code	3588
Base	GU10
Material	Zinc alloy
Shape	Round
Color of fixture	Satin Nickel
Dimension	Φ82 x 25mm
Cutting Size	Φ74mm
EAN Code	3800157607179



Model No	VT-779
SKU Code	3589
Base	GU10
Material	Zinc alloy
Shape	Round
Color of fixture	Chrome
Dimension	Φ82 x 25mm
Cutting Size	Φ74mm
EAN Code	3800157607186

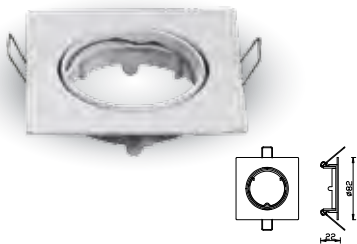

Model No	VT-779
SKU Code	3590
Base	GU10
Material	Zinc alloy
Shape	Square
Color of fixture	White
Dimension	82 x 82 x 22mm
Cutting Size	74mm
EAN Code	3800157607193

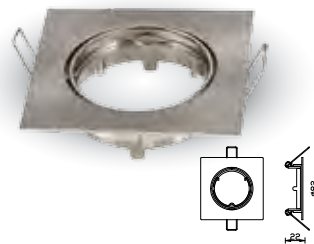

Model No	VT-779
SKU Code	3591
Base	GU10
Material	Zinc alloy
Shape	Square
Color of fixture	Satin Nickel
Dimension	82 x 82 x 22mm
Cutting Size	74mm
EAN Code	3800157607209

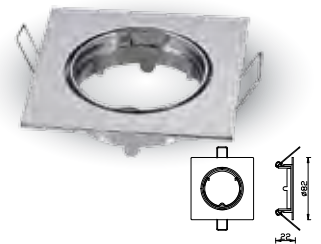

Model No	VT-779
SKU Code	3592
Base	GU10
Material	Zinc alloy
Shape	Square
Color of fixture	Chrome
Dimension	82 x 82 x 22mm
Cutting Size	74mm
EAN Code	3800157607216

Accessories LED Spotlight Fitting

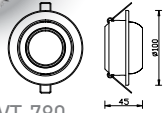

Model No	VT-780
SKU Code	3593
Base	GU10
Material	Ferrum
Shape	Round
Color of fixture	White
Dimension	Φ100 x 45mm
Cutting Size	Φ90mm
EAN Code	3800157607223

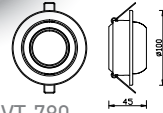

Model No	VT-780
SKU Code	3594
Base	GU10
Material	Ferrum
Shape	Round
Color of fixture	Satin Nickel
Dimension	Φ100 x 45mm
Cutting Size	Φ90mm
EAN Code	3800157607230

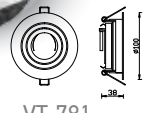

Model No	VT-781
SKU Code	3595
Base	GU10
Material	Aluminum+Ferrum
Shape	Round
Color of fixture	White
Dimension	Φ100 x 45mm
Cutting Size	Φ90mm
EAN Code	3800157607247

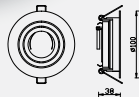

Model No	VT-781
SKU Code	3596
Base	GU10
Material	Aluminum+Ferrum
Shape	Round
Color of fixture	Satin Nickel
Dimension	Φ100 x 38mm
Cutting Size	Φ90mm
EAN Code	3800157607254

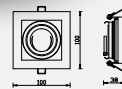

Model No	VT-781
SKU Code	3597
Base	GU10
Material	Aluminum+Ferrum
Shape	Square
Color of fixture	White
Dimension	100 x 100 x 38mm
Cutting Size	90 x 90mm
EAN Code	3800157607261

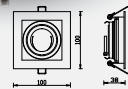

Model No	VT-781
SKU Code	3598
Base	GU10
Material	Aluminum+Ferrum
Shape	Square
Color of fixture	Satin Nickel
Dimension	100 x 100 x 38mm
Cutting Size	90 x 90mm
EAN Code	3800157607278

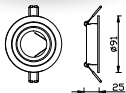

Model No	VT-782
SKU Code	3599
Base	GU10
Material	Aluminum
Shape	Round
Color of fixture	White
Dimension	Φ91 x 25mm
Cutting Size	Φ75mm
EAN Code	3800157607285

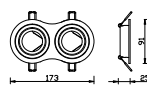

Model No	VT-783
SKU Code	3601
Base	GU10
Material	Aluminum
Shape	Round
Color of fixture	White
Dimension	173 x 91 x 25mm
Cutting Size	155 x 75mm
EAN Code	3800157607308

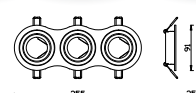

Model No	VT-784
SKU Code	3603
Base	GU10
Material	Aluminum
Shape	Round
Color of fixture	White
Dimension	255 x 91 x 25
Cutting Size	235 x 75
EAN Code	3800157607322

Accessories LED Spotlight Fitting



Model No	VT-782
SKU Code	3600
Base	GU10
Material	Aluminum
Shape	Round
Color of fixture	Aluminum Brush
Dimension	Φ91 x 25mm
Cutting Size	Φ75mm
EAN Code	3800157607292

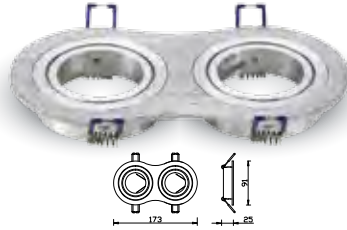

Model No	VT-783
SKU Code	3602
Base	GU10
Material	Aluminum
Shape	Round
Color of fixture	Aluminum Brush
Dimension	173 x 91 x 25mm
Cutting Size	155 x 75mm
EAN Code	3800157607315

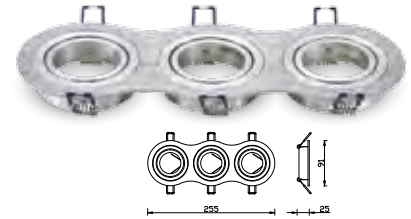

Model No	VT-784
SKU Code	3604
Base	GU10
Material	Aluminum
Shape	Round
Color of fixture	Aluminum Brush
Dimension	255 x 91 x 25mm
Cutting Size	235 x 75mm
EAN Code	3800157607339

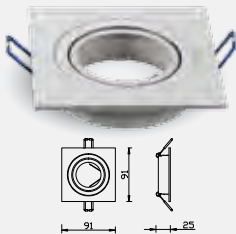

Model No	VT-782
SKU Code	3605
Base	GU10
Material	Aluminum
Shape	Square
Color of fixture	White
Dimension	91 x 91 x 25mm
Cutting Size	75mm
EAN Code	3800157607346

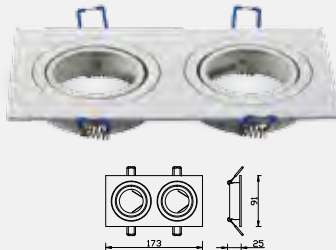

Model No	VT-783
SKU Code	3607
Base	GU10
Material	Aluminum
Shape	Square
Color of fixture	White
Dimension	173 x 91 x 25mm
Cutting Size	155 x 75mm
EAN Code	3800157607360

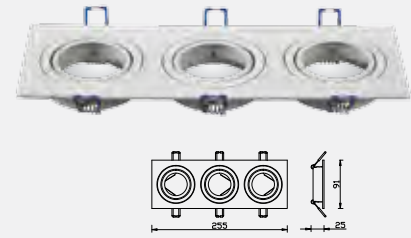

Model No	VT-784
SKU Code	3609
Base	GU10
Material	Aluminum
Shape	Square
Color of fixture	White
Dimension	255 x 91 x 25mm
Cutting Size	235 x 75mm
EAN Code	3800157607384

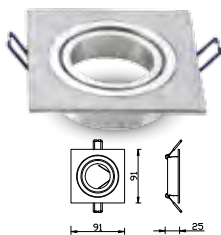

Model No	VT-782
SKU Code	3606
Base	GU10
Material	Aluminum
Shape	Square
Color of fixture	Aluminum Brush
Dimension	91 x 91 x 25mm
Cutting Size	75mm
EAN Code	3800157607353

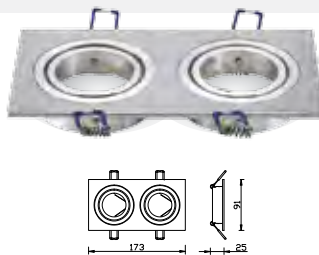

Model No	VT-783
SKU Code	3608
Base	GU10
Material	Aluminum
Shape	Square
Color of fixture	Aluminum Brush
Dimension	173 x 91 x 25mm
Cutting Size	155 x 75mm
EAN Code	3800157607377

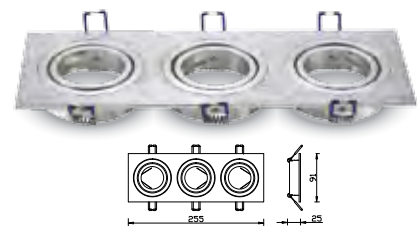

Model No	VT-784
SKU Code	3610
Base	GU10
Material	Aluminum
Shape	Square
Color of fixture	Aluminum Brush
Dimension	255 x 91 x 25mm
Cutting Size	235 x 75mm
EAN Code	3800157607391

Accessories **LED Spotlight Fitting**



Model No	VT-785
SKU Code	3611
Base	GU10
Material	Aluminum
Shape	Round
Color of fixture	White
Dimension	Φ88 x 38mm
Cutting Size	Φ75mm
EAN Code	3800157607407



Model No	VT-786
SKU Code	3612
Base	GU10
Material	Aluminum
Shape	Round
Color of fixture	White
Dimension	Φ88 x 38mm
Cutting Size	Φ75mm
EAN Code	3800157607414



Model No	VT-787
SKU Code	3613
Base	GU10
Material	Zinc alloy+Ferrum
Shape	Round
Color of fixture	White
Dimension	Φ84 x 38mm
Cutting Size	Φ75
EAN Code	3800157607421



Model No	VT-787
SKU Code	3614
Base	GU10
Material	Zinc alloy+Ferrum
Shape	Round
Color of fixture	Satin Nickel
Dimension	Φ84 x 38mm
Cutting Size	Φ75mm
EAN Code	3800157607438



Model No	VT-787
SKU Code	3615
Base	GU10
Material	Zinc alloy+Ferrum
Shape	Square
Color of fixture	White
Dimension	84 x 84 x 38mm
Cutting Size	Φ75mm
EAN Code	3800157607445



Model No	VT-787
SKU Code	3616
Base	GU10
Material	Zinc alloy+Ferrum
Shape	Square
Color of fixture	Satin Nickel
Dimension	84 x 84 x 38mm
Cutting Size	Φ75mm
EAN Code	3800157607452



Model No	VT-7227
SKU Code	3469
Holder:	GU10
Material:	Ferrum
Based:	Recessed
Body Color:	White
Shape:	Round
EAN Code	3800157605885



Model No	VT-7227
SKU Code	3470
Holder:	GU10
Material:	Ferrum
Based:	Recessed
Body Color:	Satin Nickel
Shape:	Round
EAN Code	3800157605892



Model No	VT-7227
SKU Code	3471
Holder:	GU10
Material:	Ferrum
Based:	Recessed
Body Color:	Chrome
Shape:	Round
EAN Code	3800157605908

Accessories LED Spotlight Fitting

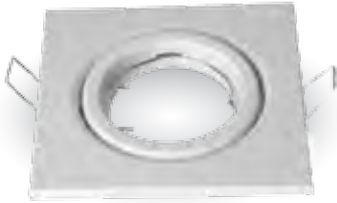

Model No	VT-7227
SKU Code	3472
Holder:	GU10
Material:	Ferrum
Based:	Recessed
Body Color:	White
Shape:	Square
EAN Code	3800157605915



Model No	VT-7227
SKU Code	3473
Holder:	GU10
Material:	Ferrum
Based:	Recessed
Body Color:	Satin Nickel
Shape:	Square
EAN Code	3800157605922



Model No	VT-7227
SKU Code	3474
Holder:	GU10
Material:	Ferrum
Based:	Recessed
Body Color:	Chrome
Shape:	Square
EAN Code	3800157605939



SKU Code	3423
Material	Ceramic
Wire Length	150mm
EAN Code	3800157607827



Model No	VT-791
SKU Code	3620
Material	Ceramic
Wire Length	158mm
EAN Code	3800157607704

Accessories **LED Spotlight Fitting**



GU 10 Holder MW
Fire Rated Fitting (Indoor Series)

Model No	VT-777
SKU Code	3579
Input voltage	AC 90-230V, 50/60Hz
Material	Pressing Metal
IP Rating	IP20
Holder	GU10
F Mark	Yes
Cut-out Min.	Min.72mm
Min. ceiling depth	1,00mn
Max Lamp size	60mm
Fire Rated	90mins
EAN Code	3800157606981

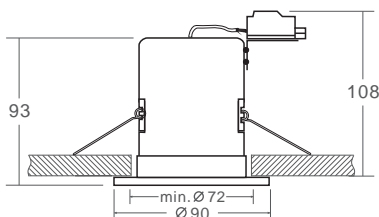

GU10 Holder SN
Fire Rated Fitting (Indoor Series)

Model No	VT-777
SKU Code	3580
Input voltage	AC 90-230V, 50/60Hz
Material	Pressing Metal
IP Rating	IP20
Holder	GU10
F Mark	Yes
Cut-out Min.	Min.72mm
Min. ceiling depth	1,00mn
Max Lamp size	60mm
Fire Rated	90mins
EAN Code	3800157606998

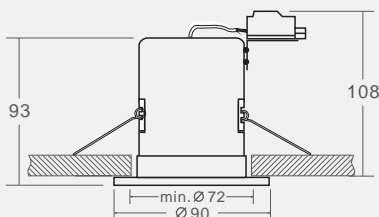



LED BULBS

An extensive collection of LED Bulbs which have been retrofitted to suit most standard Lighting Fixtures, with a wide range of wattage from 2W to 40W

PRODUCT FEATURES

- Lasts 20 times longer than Standard Bulbs
- Broad Range of holders like E27, E14, B22, B15 and G24
- Uses 80% less energy than Standard Bulbs
- Glass & Thermoplastic Body options available
- Excellent Heat Radiation Efficiency
- Customized exterior for stronger body
- High Power LED Chips
- Wide beam angle up to 300°
- Non - Flickering
- Premium Quality Power Driver
- Dimmable & Non Dimmable options

APPLICATIONS

- Widely used in Residential Lighting. LED Bulbs are the best replacement for conventional Incandescent or Fluorescent Bulbs





4W
VT-1885
4259 3000K Warmwhite
N/A 4500K Daywhite
N/A 6000K White



4W
VT-1885D
4364 3000K Warmwhite
N/A 4500K Daywhite
N/A 6000K White



6W
VT-1887
4272 3000K Warmwhite
4303 4500K Daywhite
N/A 6000K White



8W
VT-1988
4363 3000K Warmwhite
N/A 4500K Daywhite
N/A 6000K White



Model No.	VT-1885	VT-1885D	VT-1887	VT-1988
Watts	4W	4W	6W	8W
EQ. Watts	50W	30W	50W	75W
Voltage/Frequency	AC: 220-240V, 50Hz	AC: 220-240V, 50Hz	AC: 220-240V, 50Hz	AC:220-240V, 50/60Hz
Luminous Flux	400lm	320lm	550lm	1000lm
Commercial Type	A60	A60	A60	A60
LED Type	Filament	Filament	Filament	Filament
CRI	> 80	> 80	> 80	>80
PF	> 0.4	> 0.4	> 0.5	>0.5
Beam Angle	300'D	300'D	300'D	360'D
Base	E27	E27	E27	E27
Body Type	Glass	Glass	Glass	Glass
Dimension	60mm x 107mm	60mm x 107mm	60mm x 107mm	60mm x 105mm
EAN Code 3000K	3800230627179	3800157602907	3800230627667	3800157602891
EAN Code 4500K	N/A	N/A	3800157600064	N/A
EAN Code 6000K	N/A	N/A	N/A	N/A



8W
VT-1989
4406 3000K Warmwhite
N/A 4500K Daywhite
N/A 6000K White

A67
BULB TYPE

75W
EQUIVALENT

1000
LUMENS



8W
VT-1978
4407 3000K Warmwhite
4408 4500K Daywhite
4409 6000K White

A67
BULB TYPE

60W
EQUIVALENT

800
LUMENS

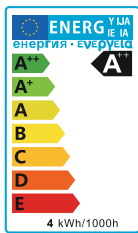



10W
VT-1981
4410 3000K Warmwhite
4411 4500K Daywhite
4412 6000K White

75W
EQUIVALENT

1055
LUMENS

A67
BULB TYPE



Model No.	VT-1989	VT-1978	VT-1981
Watts	8W	8W	10W
EQ. Watts	75W	60W	75W
Voltage/Frequency	AC:220-240V,50Hz	AC:220-240V,50Hz	AC:220-240V,50Hz
Luminous Flux	1000lm	800lm	1055lm
Commercial Type	A67	A67	A67
LED Type	Filament	Filament	Filament
CRI	>80	>80	>80
PF	>0.5	>0.5	>0.5
Beam Angle	300°D	300°D	300°D
Base	E27	E27	E27
Body Type	Glass	Glass	Glass
Dimension	67mm x 123mm	67mm x 123mm	67mm x 123mm
			
EAN Code 3000K	3800157605342	3800157606165	3800157606196
EAN Code 4500K	N/A	3800157606172	3800157606202
EAN Code 6000K	N/A	3800157606189	3800157606219



6W
VT-1987

4321 3000K Warmwhite
N/A 4500K Daywhite
N/A 6000K White



50W
EQUIVALENT

550
LUMENS

A60
BULB TYPE

 **BAYONET**



CANDLE FLAME
BULB TYPE

400
LUMENS



4W
VT-1994

4323 3000K Warmwhite
N/A 4500K Daywhite
N/A 6000K White





CANDLE
BULB TYPE

400
LUMENS



4W
VT-1984

4322 3000K Warmwhite
N/A 4500K Daywhite
N/A 6000K White

Model No.	VT-1987	VT-1994	VT-1984
Watts	6W	4W	4W
EQ. Watts	50W	40W	40W
Voltage/Frequency	AC: 220-240V, 50Hz	AC: 220-240V, 50Hz	AC: 220-240V, 50Hz
Luminous Flux	550lm	400lm	400lm
Commercial Type	A60	Candle Flame	Candle
LED Type	Filament	Filament	Filament
CRI	> 80	> 80	> 80
PF	> 0.5	> 0.4	> 0.4
Beam Angle	300°D	300°D	300°D
Base	B22	B15	B15
Body Type	Glass	Glass	Glass
Dimension	60mm x 107mm	35mm x 121mm	35mm x 100mm
			
EAN Code 3000K	3800157601016	3800157601030	3800157601023
EAN Code 4500K	N/A	N/A	N/A
EAN Code 6000K	N/A	N/A	N/A



2W
VT-1886 4260 3000K Warmwhite
N/A 4500K Daywhite
N/A 6000K White







4W
VT-1986 4301 3000K Warmwhite
4413 4500K Daywhite
4414 6000K White



4W
VT-1985 4307 3000K Warmwhite
N/A 4500K Daywhite
N/A 6000K White



4W
VT-1982 4662 2200K Warmwhite
N/A 4500K Daywhite
N/A 6000K White *amber COVER*

Model No.	VT-1886	VT-1986	VT-1985	VT-1982
Watts	2W	4W	4W	4W
EQ. Watts	20W	40W	40W	35W
Voltage/Frequency	AC: 220-240V, 50 Hz	AC: 220-240V, 50Hz	AC: 220-240V, 50Hz	AC: 220-240V, 50Hz
Luminous Flux	180lm	400lm	400lm	320lm
Commercial Type	Candle	Candle	Candle	Candle
LED Type	Filament	Filament	Filament	Filament
CRI	> 80	> 80	> 80	/
PF	N/A	> 0.4	> 0.4	> 0.4
Beam Angle	300°D	300°D	300°D	300°D
Base	E14	E14	E14	E14
Body Type	Glass	Glass	Glass	Glass
Dimension	35mm x 100mm	35mm x 100mm	35mm x 100mm	35mm x 100mm
				
EAN Code 3000K	3800230627186	3800230629951	3800157600347	3800157608275
EAN Code 4500K	N/A	3800157606226	N/A	N/A
EAN Code 6000K	N/A	3800157606233	N/A	N/A



**CANDLE
FLAME**
BULB TYPE

180
LUMENS



2W
VT-1897

4291 3000K Warmwhite
 4320 4500K Daywhite
 N/A 6000K White



**CANDLE
FLAME**
BULB TYPE

400
LUMENS



4W
VT-1997

4302 3000K Warmwhite
 4429 4500K Daywhite
 4430 6000K White





4W
VT-1995

4308 3000K Warmwhite
 4431 4500K Daywhite
 4432 6000K White

**CANDLE
FLAME**
BULB TYPE

400
LUMENS



Model No.	VT-1897	VT-1997	VT-1995
Watts	2W	4W	4W
EQ. Watts	20W	40W	40W
Voltage/Frequency	AC: 220-240V, 50 Hz	AC: 220-240V, 50Hz	AC: 220-240V, 50Hz
Luminous Flux	180lm	400lm	400lm
Commercial Type	Candle Flame	Candle Flame	Candle Flame
LED Type	Filament	Filament	Filament
CRI	> 80	> 80	> 80
PF	N/A	> 0.4	> 0.4
Beam Angle	300°D	300°D	300°D
Base	E14	E14	E14
Body Type	Glass	Glass	Glass
Dimension	35mm x 121mm	35mm x 121mm	35mm x 121mm
			
EAN Code 3000K	3800230628848	3800230629968	3800157600354
EAN Code 4500K	3800157600972	3800157606431	3800157606455
EAN Code 6000K	N/A	3800157606448	3800157606462



DIMMABLE

320 LUMENS

E14

CANDLE
BULB TYPE

4W 4365 3000K Warmwhite
N/A 4500K Daywhite
N/A 6000K White

VT-1986D



DIMMABLE

320 LUMENS

CANDLE FLAME
BULB TYPE

E14

4W 4366 3000K Warmwhite
N/A 4500K Daywhite
N/A 6000K White

VT-1997D



DIMMABLE

320 LUMENS

E14

CANDLE
BULB TYPE

4W 4367 3000K Warmwhite
N/A 4500K Daywhite
N/A 6000K White

VT-1985D



DIMMABLE





320 LUMENS

CANDLE FLAME
BULB TYPE

E14

4W 4388 3000K Warmwhite
N/A 4500K Daywhite
N/A 6000K White

VT-1995D

Model No.	VT-1986D	VT-1997D	VT-1985D	VT-1995D
Watts	4W	4W	4W	4W
EQ. Watts	30W	30W	30W	30W
Voltage/Frequency	AC:220-240V, 50Hz	AC:220-240V, 50Hz	AC:220-240V, 50Hz	AC: 220-240V, 50Hz
Luminous Flux	320lm	320lm	320lm	320lm
Commercial Type	Candle	Candle Flame	Candle	Candle Flame
LED Type	Filament	Filament	Filament	Filament
CRI	>80	>80	>80	> 80
PF	>0.4	>0.4	>0.4	> 0.4
Beam Angle	300°D	300°D	300°D	300°D
Base	E14	E14	E14	E14
Body Type	Glass	Glass	Glass	Glass
Dimension	37mm x 100mm	35mm x 121mm	37mm x 100mm	35mm x 121mm
				
EAN Code 3000K	3800157602914	3800157602921	3800157602938	3800157603973
EAN Code 4500K	N/A	N/A	N/A	N/A
EAN Code 6000K	N/A	N/A	N/A	N/A



G45
 BULB TYPE

180
 LUMENS

E27

2W
VT-1895

4261 3000K Warmwhite
 N/A 4500K Daywhite
 N/A 6000K White



G45
 BULB TYPE

400
 LUMENS

E27

4W
VT-1980

4306 3000K Warmwhite
 4427 4500K Daywhite
 4428 6000K White

4W
VT-1980D

4395 3000K Warmwhite
 N/A 4500K Daywhite
 N/A 6000K White



G45
 BULB TYPE

320
 LUMENS

E27

DIMMABLE



Model No.	VT-1895	VT-1980	VT-1980D
Watts	2W	4W	4W
EQ. Watts	20W	40W	30W
Voltage/Frequency	AC: 220-240V, 50Hz	AC: 220-240V, 50Hz	AC:220-240V,50Hz
Luminous Flux	180lm	400lm	320lm
Commercial Type	G45	G45	G45
LED Type	Filament	Filament	Filament
CRI	> 80	> 80	>80
PF	> 0.4	> 0.4	>0.4
Beam Angle	300°D	300°D	300°D
Base	E27	E27	E27
Body Type	Glass	Glass	Glass
Dimension	45mm x 75mm	45mm x 75mm	45mm x 75mm
			
EAN Code 3000K	3800230627209	3800157600330	3800157604796
EAN Code 4500K	N/A	3800157606417	N/A
EAN Code 6000K	N/A	3800157606424	N/A



P45
BULB TYPE

180
LUMENS

E14

2W
VT-1896

4262 3000K Warmwhite
N/A 4500K Daywhite
N/A 6000K White



P45
BULB TYPE

400
LUMENS

E14

4W
VT-1996

4300 3000K Warmwhite
4425 4500K Daywhite
4426 6000K White

4W
VT-1996D

4394 3000K Warmwhite
N/A 4500K Daywhite
N/A 6000K White



P45
BULB TYPE

320
LUMENS

E14

DIMMABLE



Model No.	VT-1896	VT-1996	VT-1996D
Watts	2W	4W	4W
EQ. Watts	20W	a0W	30W
Voltage/Frequency	AC: 220-240V, 50Hz	AC: 220-240V, 50Hz	AC:220-240V,50Hz
Luminous Flux	180lm	400lm	320lm
Commercial Type	P45	P45	P45
LED Type	Filament	Filament	Filament
CRI	> 80	> 80	>80
PF	> 0.4	> 0.4	>0.4
Beam Angle	300°D	300°D	300°D
Base	E14	E14	E14
Body Type	Glass	Glass	Glass
Dimension	45mm x 77mm	45mm x 77mm	45mm x 77mm
			
EAN Code 3000K	3800230627216	3800230629944	3800157604314
EAN Code 4500K	N/A	3800157606394	N/A
EAN Code 6000K	N/A	3800157606400	N/A



2W
VT-1961

4309 3000K Warmwhite
N/A 4500K Daywhite
N/A 6000K White

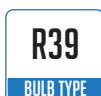

160
LUMENS



4W
VT-1976

4310 3000K Warmwhite
N/A 4500K Daywhite
N/A 6000K White



320
LUMENS





6W
VT-1962

4311 3000K Warmwhite
N/A 4500K Daywhite
N/A 6000K White



400
LUMENS



Model No.	VT-1961	VT-1976	VT-1962
Watts	2W	4W	6W
EQ. Watts	/	/	/
Voltage/Frequency	AC: 220-240V, 50Hz	AC: 220-240V, 50Hz	AC: 220-240V, 50Hz
Luminous Flux	160lm	320lm	400lm
Commercial Type	R39	R50	R63
LED Type	Filament	Filament	Filament
CRI	> 80	> 80	> 80
PF	/	> 0.4	> 0.4
Beam Angle	70'D	70'D	70'D
Base	E14	E14	E27
Body Type	Glass	Glass	Glass
Dimension	39mm x 67mm	50mm x 86mm	63mm x 100mm
			
EAN Code 3000K	3800157600361	3800157600378	3800157600385
EAN Code 4500K	N/A	N/A	N/A
EAN Code 6000K	N/A	N/A	N/A



4W
VT-1994D 4399 3000K WarmWhite
N/A 4500K DayWhite
N/A 6000K White  **DIMMABLE**







6W
VT-1983 4304 3000K Warmwhite
N/A 4500K Daywhite
N/A 6000K White



6W
VT-1993 4305 3000K Warmwhite
N/A 4500K Daywhite
N/A 6000K White



10W
VT-1979 4422 3000K WarmWhite
4423 4500K DayWhite
4424 6000K White

Model No.	VT-1994D	VT-1983	VT-1993	VT-1979
Watts	4W	6W	6W	10W
EQ. Watts	30W	60W	60W	75W
Voltage/Frequency	AC:220-240V,50Hz	AC: 220-240V, 50Hz	AC: 220-240V, 50Hz	AC:220-240V,50Hz
Luminous Flux	320lm	550lm	550lm	1055lm
Commercial Type	G125	G125	G95	G125
LED Type	Filament	Filament	Filament	Filament
CRI	>80	> 80	> 80	>80
PF	>0.5	> 0.5	> 0.5	>0.5
Beam Angle	300°D	300°D	300°D	300°D
Base	E27	E27	E27	E27
Body Type	Glass	Glass	Glass	Glass
Dimension	125mm x 165mm	125mm x 165mm	95mm x 135mm	125mm x 165mm
				
EAN Code 3000K	3800157605021	3800157600316	3800157600323	3800157606363
EAN Code 4500K	N/A	N/A	N/A	3800157606370
EAN Code 6000K	N/A	N/A	N/A	3800157606387



2W
VT-1952

4444 3000K Warmwhite
 4445 4500K Daywhite
 4446 6000K White

180
 LUMENS



Model No.	VT-1952
Watts	2W
EQ. Watts	25W
Voltage/Frequency	AC:220-240V,50Hz
Luminous Flux	180lm
Commercial Type	ST 26
LED Type	Filament
CRI	>80
PF	/
Beam Angle	300°
Base	E14
Body Type	Glass
Dimension	26 x 58 mm



EAN Code 3000K
 EAN Code 4500K
 EAN Code 6000K

3800157607858
 3800157607865
 3800157607872





ST64
BULB TYPE



amber
COVER



4W
VT-1964

4361 2200K Warmwhite
N/A 4500K Daywhite
N/A 6000K White

4W
VT-1964D  **DIMMABLE**





4368 2200K Warmwhite
N/A 4500K Daywhite
N/A 6000K White

6W
VT-1966

4362 2200K Warmwhite
N/A 4500K Daywhite
N/A 6000K White

8W
VT-1968

4421 2200K WarmWhite
N/A 4500K DayWhite
N/A 6000K White

Model No.	VT-1964	VT-1964D	VT-1966	VT-1968
Watts	4W	4W	6W	8W
EQ. Watts	40W	30W	60W	55W
Voltage/Frequency	AC:220-240V, 50Hz	AC:220-240V, 50Hz	AC:220-240V, 50Hz	AC:220-240V,50Hz
Luminous Flux	350lm	350lm	500lm	700lm
Commercial Type	ST64	ST64	ST64	ST64
LED Type	Filament	Filament	Filament	Filament
CRI	>80	>80	>80	>80
PF	>0.4	>0.7	>0.5	>0.5
Beam Angle	300°D	300°D	300°D	300°D
Base	E27	E27	E27	E27
Body Type	Glass	Glass	Glass	Glass
Dimension	58mm x 139mm	58mm x 139mm	58mm x 139mm	64mm x 138mm
				
EAN Code 2200K	3800157602747	3800157602945	3800157602754	3800157606356
EAN Code 4500K	N/A	N/A	N/A	N/A
EAN Code 6000K	N/A	N/A	N/A	N/A



10W
VT-1990

4369 3000K Warmwhite
 4389 4500K Daywhite
 4390 6000K White

R7S
 BULB TYPE

1000
 LUMENS

Model No.	VT-1989
Watts	10W
EQ. Watts	60W
Voltage/Frequency	AC:220-240V, 50Hz
Luminous Flux	1000lm
Commercial Type	R7S
LED Type	SMD
CRI	>80
PF	>0.5
Beam Angle	360'D
Base	R7S
Body Type	Plastic
Dimension	25mm x 118mm



EAN Code 3000K	3800157602952
EAN Code 4500K	3800157604130
EAN Code 6000K	3800157604147

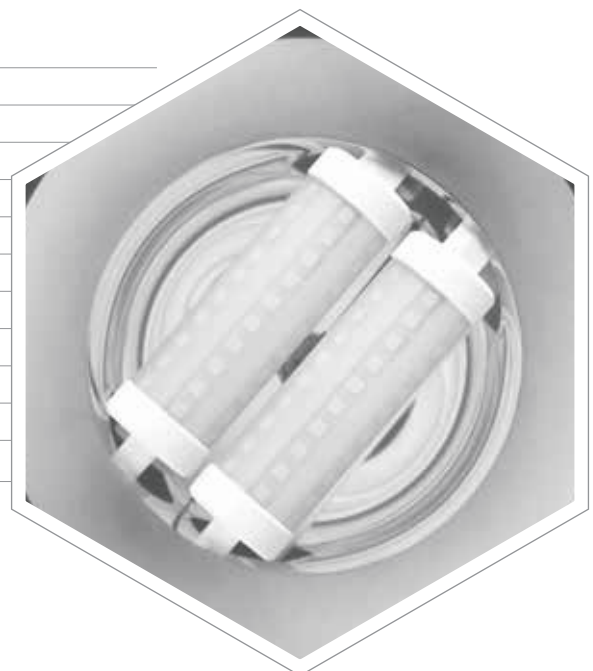



7W
VT-2007

4376 3000K Warmwhite
4377 4500K Daywhite
4378 6000K White

470
LUMENS

45W **A60**
EQUIVALENT BULB TYPE



10W
VT-1853

4209 3000K Warmwhite
4226 4500K Daywhite
4227 6000K White

806
LUMENS

60W **A60**
EQUIVALENT BULB TYPE



12W
VT-1864

4228 3000K Warmwhite
4229 4500K Daywhite
4230 6000K White

1055
LUMENS

75W **A60**
EQUIVALENT BULB TYPE







14W
VT-2014

4355 3000K Warmwhite
4356 4500K Daywhite
4357 6000K White

1320
LUMENS

90W **A60**
EQUIVALENT BULB TYPE

Model No.	VT-2007	VT-1853	VT-1864	VT-2014
Watts	7W	10W	12W	14W
EQ. Watts	45W	60W	75W	90W
Voltage/Frequency	AC:220-240V, 50Hz	AC: 220-240V,50Hz	AC: 220-240V,50Hz	AC:220-240V,50Hz
Luminous Flux	470lm	806lm	1055lm	1320lm
Commercial Type	A60	A60	A60	A60
LED Type	SMD	SMD	SMD	SMD
CRI	>80	> 80	> 80	>80
PF	>0.5	> 0.5	> 0.7	>0.7
Beam Angle	200°D	200°D	200°D	200°D
Base	E27	E27	E27	E27
Body Type	Thermal Plastic	Thermal Plastic	Thermal Plastic	Thermal Plastic
Dimension	60mm x 108mm	60mm x 112mm	60mm x 118mm	60mm x 118mm
				
EAN Code 3000K	3800157603850	3800230623591	3800230626295	3800157602563
EAN Code 4500K	3800157603867	3800230626271	3800230626301	3800157602570
EAN Code 6000K	3800157603874	3800230626288	3800230626318	3800157602587



14W
VT-2013

4400 3000K Warmwhite
 4401 4500K Daywhite
 4402 6000K White

90W
 EQUIVALENT

1320
 LUMENS

A65
 BULB TYPE



15W
VT-2015

4403 3000K Warmwhite
 4404 4500K Daywhite
 4405 6000K White

100W
 EQUIVALENT

1500
 LUMENS

A65
 BULB TYPE

17W
VT-2017



4396 3000K Warmwhite
 4397 4500K Daywhite
 4398 6000K White

120W
 EQUIVALENT

1800
 LUMENS

A65
 BULB TYPE



Model No.	VT-2013	VT-2015	VT-2017
Watts	14W	15W	17W
EQ. Watts	90W	100W	120W
Voltage/Frequency	AC:220-240V,50Hz	AC:220-240V,50Hz	AC:220-240V,50Hz
Luminous Flux	1320lm	1500lm	1800lm
Commercial Type	A65	A65	A65
LED Type	SMD	SMD	SMD
CRI	>80	>80	>80
PF	>0.5	>0.5	>0.5
Beam Angle	130'D	130'D	130'D
Base	E27	E27	E27
Body Type	Thermal Plastic	Thermal Plastic	Thermal Plastic
Dimension	65mm x 130mm	65mm x 130mm	65mm x 130mm
			
EAN Code 3000K	3800157605069	3800157605090	3800157604994
EAN Code 4500K	3800157605076	3800157605106	3800157605007
EAN Code 6000K	3800157605083	3800157605113	3800157605014



14W
VT-2013

4450 3000K WarmWhite
4451 4500K DayWhite
4452 6000K White



90W
EQUIVALENT

1320
LUMENS

A65
BULB TYPE

200°
BEAM ANGLE



15W
VT-2015

4453 3000K WarmWhite
4454 4500K DayWhite
4455 6000K White



100W
EQUIVALENT

1500
LUMENS

A65
BULB TYPE

200°
BEAM ANGLE

17W
VT-2017

4456 3000K WarmWhite
4457 4500K DayWhite
4458 6000K White



125W
EQUIVALENT

1800
LUMENS

A65
BULB TYPE

200°
BEAM ANGLE



Model No.	VT-2013	VT-2015	VT-2017
Watts	14W	15W	17W
EQ. Watts	90W	100W	125W
Voltage/Frequency	AC:220-240V,50Hz	AC:220-240V,50Hz	AC:220-240V,50Hz
Luminous Flux	1320lm	1500lm	1800lm
Commercial Type	A65	A65	A65
LED Type	SMD	SMD	SMD
CRI	>80	>80	>80
PF	>0.5	>0.5	>0.5
Beam Angle	200°D	200°D	200°D
Base	E27	E27	E27
Body Type	Thermal Plastic	Thermal Plastic	Thermal Plastic
Dimension	65mm x 130mm	65mm x 130mm	65mm x 130mm



EAN Code 3000K [3800157608060](#)
EAN Code 4500K [3800157608077](#)
EAN Code 6000K [3800157608084](#)



[3800157608091](#)
[3800157608107](#)
[3800157608114](#)



[3800157608121](#)
[3800157608138](#)
[3800157608145](#)



7W
VT-2007D

4379 3000K Warmwhite
 4380 4500K Daywhite
 4381 6000K White



DIMMABLE

40W

EQUIVALENT



470
 LUMENS

A60

BULB TYPE



10W
VT-1853D

4282 3000K Warmwhite
 N/A 4500K Daywhite
 N/A 6000K White



DIMMABLE

60W

EQUIVALENT



806
 LUMENS

A60

BULB TYPE



12W
VT-1864D

4275 3000K Warmwhite
 N/A 4500K Daywhite
 N/A 6000K White



DIMMABLE

75W



EQUIVALENT



1055
 LUMENS

A60

BULB TYPE

Model No.	VT-2007D	VT-1853D	VT-1864D
Watts	7W	10W	12W
EQ. Watts	40W	60W	75W
Voltage/Frequency	AC:220-240V, 50Hz	AC: 220-240V, 50Hz	AC: 220-240V,50Hz
Luminous Flux	470lm	806lm	1055lm
Commercial Type	A60	A60	A60
LED Type	SMD	SMD	SMD
CRI	>80	> 80	> 80
PF	>0.5	> 0.5	> 0.7
Beam Angle	200°D	200°D	200°D
Base	E27	E27	E27
Body Type	Thermal Plastic	Thermal Plastic	Thermal Plastic
Dimension	60mm x 108mm	60mm x 108mm	60mm x 118mm
			
EAN Code 3000K	3800157603881	3800230628503	3800230627872
EAN Code 4500K	3800157603898	N/A	N/A
EAN Code 6000K	3800157603904	N/A	N/A

7W
VT-1828

4175 3000K Warmwhite
4197 4500K Daywhite
4176 6000K White



45W
EQUIVALENT

470
LUMENS

A60
BULB TYPE



BAYONET

10W
VT-1853

4442 3000K Warmwhite
4443 4500K Daywhite
4324 6000K White



60W
EQUIVALENT

806
LUMENS

A60
BULB TYPE



Model No.	VT-1828	VT-1853
Watts	7W	10W
EQ. Watts	45W	60W
Voltage/Frequency	AC: 220-240V,50Hz	AC: 220-240V,50Hz
Luminous Flux	470lm	806lm
Commercial Type	A60	A60
LED Type	SMD	SMD
CRI	> 80	> 80
PF	> 0.5	> 0.5
Beam Angle	270'D	200'D
Base	B22	B22
Body Type	Plastic Clad Aluminum	Thermal Plastic
Dimension	60mm x 108mm	60mm x 108mm



EAN Code 3000K **3800230620859**
EAN Code 4500K **3800230624437**
EAN Code 6000K **3800230620866**



3800157607681
3800157607698
3800157601061



9W
VT-2016

4459 3000K Warmwhite
4460 4500K Daywhite
4461 6000K White

60W
EQUIVALENT

806
LUMENS

A60
BULB TYPE

WITH
SENSOR
LIGHT

Our smart sensor bulbs are built in with photocells with transmits Signal to light source as per lumen conditions smartly and saves power by going onto Light mode, enabling you to save power and reduce consumption of power when not required.



9W
VT-2011

4447 3000K Warmwhite
4448 4500K Daywhite
4449 6000K White

60W
EQUIVALENT

806
LUMENS

A60
BULB TYPE

3 STEP
DIMMING

At the click of button, change the lighting Power from 100% to 50% and if need to Reduce more click again to go to 25%.

SMART DIMMING TECHNOLOGY
WITHOUT A DIMMER!

Model No.	VT-2016	VT-2011
Watts	9W	9W
EQ. Watts	60W	60W
Voltage/Frequency	AC: 220-240V,50Hz	AC: 220-240V,50Hz
Luminous Flux	806lm	806lm
Commercial Type	A60	A60
LED Type	SMD	SMD
CRI	>80	>80
PF	>0.5	>0.5
Beam Angle	200°D	200°D
Base	E27	E27
Body Type	Plastic	Plastic
Dimension	60mm x 112 mm	60mm x 112 mm



EAN Code 3000K 3800157608237
EAN Code 4500K 3800157608244
EAN Code 6000K 3800157608251



3800157607988
3800157607995
3800157608008



4W
VT-1818

4216 3000K Warmwhite
4166 4500K Daywhite
4122 6000K White





4W
VT-1818 TP

4164 3000K Warmwhite
4156 4500K Daywhite
4354 6000K White

4W
VT-1865

4231 3000K Warmwhite
N/A 4500K Daywhite
N/A 6000K White



Model No.	VT-1818	VT-1818TP	VT-1865
Watts	4W	4W	4W
EQ. Watts	30W	30W	30W
Voltage/Frequency	AC: 220-240V,50Hz	AC: 220-240V,50Hz	AC: 220-240V,50Hz
Luminous Flux	320lm	320lm	320lm
Commercial Type	Candle	Candle Flame	Candle
LED Type	SMD	SMD	SMD
CRI	> 80	> 80	> 80
PF	> 0.4	> 0.4	> 0.4
Beam Angle	200°D	200°D	200°D
Base	E14	E14	B22
Body Type	Plastic	Plastic	Plastic
Dimension	38mm x 107mm	38mm x 128mm	38mm x 105mm
			
EAN Code 3000K	3800230624796	3800230620743	3800230626325
EAN Code 4500K	3800230620675	3800230620736	N/A
EAN Code 6000K	3800230620668	3800157602457	N/A



6W
VT-1854D 4213 3000K Warmwhite
N/A 4500K Daywhite
N/A 6000K White







6W
VT-1855 4215 3000K Warmwhite
4258 4500K Daywhite
4241 6000K White



6W
VT-1856D 4214 3000K Warmwhite
N/A 4500K Daywhite
N/A 6000K White



6W
VT-1857 4217 3000K Warmwhite
N/A 4500K Daywhite
N/A 6000K White

Model No.	VT-1854D	VT-1855	VT-1856D	VT-1857
Watts	6W	6W	6W	6W
EQ. Watts	40W	40W	40W	40W
Voltage/Frequency	AC: 220-240V,50Hz	AC: 220-240V,50Hz	AC: 220-240V,50Hz	AC: 220-240V, 50Hz
Luminous Flux	470lm	470lm	470lm	470lm
Commercial Type	Candle	Candle	Candle	Candle
LED Type	SMD	SMD	SMD	SMD
CRI	> 80	> 80	> 80	> 80
PF	> 0.5	> 0.5	> 0.5	> 0.5
Beam Angle	200'D	200'D	200'D	200'D
Base	E14	E14	B15	B15
Body Type	Plastic	Plastic	Plastic	Plastic
Dimension	37mm x 103mm	37mm x103mm	37mm x103mm	37mm x 103mm
				
EAN Code 3000K	3800230624765	3800230624789	3800230624772	3800230624802
EAN Code 4500K	N/A	3800230627155	N/A	N/A
EAN Code 6000K	N/A	3800230626790	N/A	N/A



6W
VT-1821

4342 3000K Warmwhite
4343 4500K Daywhite
4344 6000K White



6W
VT-1855TP



4351 3000K Warmwhite
4352 4500K Daywhite
4353 6000K White



6W
VT-1965

4440 3000K WarmWhite
N/A 4500K DayWhite
N/A 6000K White



Model No.	VT-1821	VT-1855TP	VT-1965
Watts	6W	6W	6W
EQ. Watts	40W	40W	40W
Voltage/Frequency	AC:220-240V, 50Hz	AC: 220-240V,50Hz	AC:220-240V,50Hz
Luminous Flux	470lm	470lm	470lm
Commercial Type	Candle	Candle Flame	Candle
LED Type	SMD	SMD	SMD
CRI	>80	>80	>80
PF	>0.5	>0.5	>0.5
Beam Angle	200°D	200°D	200°D
Base	E27	E14	B22
Body Type	Plastic	Plastic	Plastic
Dimension	37mm x 103mm	37mm x 121mm	37mm x 100mm
			
EAN Code 3000K	3800157601733	3800157602426	3800157604796
EAN Code 4500K	3800157601740	3800157602433	N/A
EAN Code 6000K	3800157601757	3800157602440	N/A



G45
BULB TYPE



4W
VT-1872 4232 3000K Warmwhite
N/A 4500K Daywhite
N/A 6000K White



G45
BULB TYPE



4W
VT-1830 4160 3000K Warmwhite
4162 4500K Daywhite
4207 6000K White



G45
BULB TYPE



6W
VT-1879 4247 3000K Warmwhite
4248 4500K Daywhite
4249 6000K White



G45
BULB TYPE



6W
VT-1973 4441 3000K WarmWhite
N/A 4500K DayWhite
N/A 6000K White

Model No.	VT-1872	VT-1830	VT-1879	VT-1973
Watts	4W	4W	6W	6W
EQ. Watts	30W	30W	40W	40W
Voltage/Frequency	AC: 170-240V, 50Hz	AC: 220-240V,50Hz	AC: 220-240V,50Hz	AC:220-240V,50Hz
Luminous Flux	320lm	320lm	470lm	470lm
Commercial Type	G45	G45	G45	G45
LED Type	SMD	SMD	SMD	SMD
CRI	> 80	> 80	> 80	>80
PF	> 0.4	> 0.5	> 0.5	>0.5
Beam Angle	180°D	180°D	180°D	180°D
Base	B22	E27	E27	B22
Body Type	Plastic Clad Aluminum	Plastic Clad Aluminum	Plastic	Plastic
Dimension	45mm x 74mm	45mm x 75mm	45mm x 75mm	45mm x 82mm
EAN Code 3000K	3800230626332	3800230621047	3800230627018	3800157607674
EAN Code 4500K	N/A	3800230621054	3800230627025	N/A
EAN Code 6000K	N/A	3800230624611	3800230627032	N/A



4W
VT-1819

4123 3000K Warmwhite
4174 4500K Daywhite
4124 6000K White



6W
VT-1880

4250 3000K Warmwhite
4251 4500K Daywhite
4252 6000K White



Model No.	VT-1819	VT-1880
Watts	4W	6W
EQ. Watts	30W	40W
Voltage/Frequency	AC: 220-240V,50Hz	AC: 220-240V,50Hz
Luminous Flux	320lm	470lm
Commercial Type	P45	P45
LED Type	SMD	SMD
CRI	> 80	> 80
PF	> 0.4	> 0.5
Beam Angle	180°D	180°D
Base	E14	E14
Body Type	Plastic	Plastic
Dimension	45mm x 78mm	45mm x 80mm



EAN Code 3000K [3800230620996](#)
 EAN Code 4500K [3800230621009](#)
 EAN Code 6000K [3800230621016](#)

[3800230627049](#)
[3800230627056](#)
[3800230627063](#)



5W
VT-1861

4219 3000K Warmwhite
 4220 4500K Daywhite
 4242 6000K White



6W
VT-1876

4243 3000K Warmwhite
 4138 4500K Daywhite
 4246 6000K White



8W
VT-1862





4221 3000K Warmwhite
 4140 4500K Daywhite
 4244 6000K White



10W
VT-1894

4339 3000K Warmwhite
 4340 4500K Daywhite
 4341 6000K White



Model No.	VT-1861	VT-1876	VT-1862	VT-1894
Watts	3W	6W	8W	10W
EQ. Watts	/	/	/	/
Voltage/Frequency	AC: 220-240V,50Hz	AC: 220-240V,50Hz	AC: 220-240V,50Hz	AC:220-240V, 50Hz
Luminous Flux	210lm	400lm	500lm	800lm
Commercial Type	R39	R50	R63	R80
LED Type	SMD	SMD	SMD	SMD
CRI	> 80	> 80	> 80	>80
PF	> 0.4	> 0.4	> 0.5	>0.5
Beam Angle	120'D	120'D	120'D	120'D
Base	E14	E14	E27	E27
Body Type	Plastic	Plastic	Plastic	Plastic
Dimension	39mm x 67mm	50mm x 86mm	63mm x 100mm	80mm x 114mm
				
EAN Code 3000K	3800230625472	3800230626813	3800230625496	3800157601702
EAN Code 4500K	3800230625489	3800230620897	3800230620903	3800157601719
EAN Code 6000K	3800230626806	3800230626967	3800230626820	3800157601726

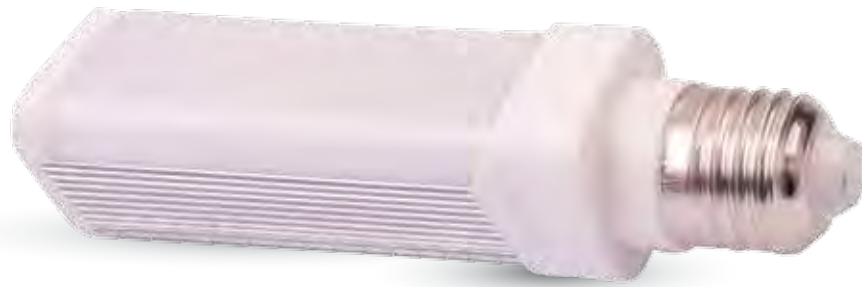





6W 4372 3000K Warmwhite
VT-1926 4109 4500K Daywhite
4110 6000K White

10W 4374 3000K Warmwhite
VT-1929 4126 4500K Daywhite
4125 6000K White



6W 4373 3000K Warmwhite
VT-1926 4115 4500K Daywhite
4116 6000K White

10W 4375 3000K Warmwhite
VT-1929 4298 4500K Daywhite
4299 6000K White

Model No.	VT-1926	VT-1929	VT-1926	VT-1929
Watts	6W	10W	6W	10W
EQ. Watts	60W	100W	60W	100W
Voltage/Frequency	AC: 200-240V, 50Hz	AC: 200-240V, 50Hz	AC: 200-240V, 50Hz	AC: 200-240V, 50Hz
Luminous Flux	485lm	850lm	485lm	850lm
Commercial Type	PL	PL	PL	PL
LED Type	SMD	SMD	SMD	SMD
CRI	> 80	> 80	> 80	> 80
PF	> 0.6	> 0.6	> 0.6	> 0.6
Beam Angle	120'D	120'D	120'D	120'D
Base	E27	E27	G24	G24
Body Type	Plastic + Aluminum	Plastic + Aluminum	Plastic + Aluminum	Plastic + Aluminum
Dimension	38mm x147mm	38mm x165mm	38mm x147mm	38mm x 165mm
				
EAN Code 3000K	3800157603683	3800157603706	3800157603676	3800157603690
EAN Code 4500K	3800230621122	3800230629692	3800230621085	3800230621108
EAN Code 6000K	3800230621139	3800230629708	3800230621092	3800230621115





10W
VT-1893

4276 3000K Warmwhite
4277 4500K Daywhite
4278 6000K White

10W
VT-1893D 

4279 3000K Warmwhite
N/A 4500K Daywhite
N/A 6000K White

Model No.	VT-1893	VT-1893D
Watts	10W	10W
EQ. Watts	60W	60W
Voltage/Frequency	AC: 200-240V,50Hz	AC: 200-240V,50Hz
Luminous Flux	810lm	810lm
Commercial Type	G95	G95
LED Type	SMD	SMD
CRI	> 80	> 80
PF	> 0.5	> 0.5
Beam Angle	200'D	200'D
Base	E27	E27
Body Type	Thermal Plastic	Thermal Plastic
Dimension	95mm x 133mm	95mm x 133mm
		
EAN Code 3000K	3800230627889	3800230627919
EAN Code 4500K	3800230627896	N/A
EAN Code 6000K	3800230627902	N/A



13W
VT-1883

4253 3000K Warmwhite
4273 4500K Daywhite
4274 6000K White

13W
VT-1884D DIMMABLE

4254 3000K Warmwhite
N/A 4500K Daywhite
N/A 6000K White

15W
VT-1898

4385 3000K Warmwhite
4386 4500K Daywhite
4387 6000K White

18W
VT-1899

4433 3000K WarmWhite
4434 4500K DayWhite
4435 6000K White

Model No.	VT-1883	VT-1884D	VT-1898	VT-1899
Watts	13W	13W	15W	18W
EQ. Watts	75W	75W	100W	115W
Voltage/Frequency	AC: 200-240V,50Hz	AC: 200-240V,50Hz	AC:220-240V,50Hz	AC:220-240V,50Hz
Luminous Flux	1055lm	1055lm	1300lm	1800lm
Commercial Type	G120	G120	G120	G120
LED Type	SMD	SMD	SMD	SMD
CRI	> 80	> 80	>80	>80
PF	> 0.7	> 0.7	>0.7	>0.5
Beam Angle	200'D	200'D	200'D	200'D
Base	E27	E27	E27	E27
Body Type	Plastic	Plastic	Plastic	Plastic
Dimension	120mm x 158mm	120mm x 158mm	120mm x 158mm	120mm x 158mm
EAN Code 3000K	3800230627094	3800230627100	3800157603942	3800157606806
EAN Code 4500K	3800230627858	N/A	3800157603959	3800157606813
EAN Code 6000K	3800230627865	N/A	3800157603966	3800157606820



20W
VT-1921

4345 3000K Warmwhite
 4346 4500K Daywhite
 4347 6000K White



Model No.	VT-1921
Watts	20W
EQ. Watts	120W
Voltage/Frequency	AC:100-240V,50Hz/60Hz
Luminous Flux	1600lm
Commercial Type	Big bulb
LED Type	SMD
CRI	>80
PF	>0.7
Beam Angle	200'D
Base	E27
Body Type	Plastic
Dimension	99.6mm x 190mm



EAN Code 3000K
 EAN Code 4500K
 EAN Code 6000K

[3800157602266](#)
[3800157602273](#)
[3800157602280](#)





30W
VT-1930

N/A 3000K Warmwhite
4280 4500K Daywhite
4281 6000K White

40W
VT-1945

4292 3000K Warmwhite
4293 4500K Daywhite
4294 6000K White

Model No.	VT-1930	VT-1945
Watts	30W	40W
EQ. Watts	150W	200W
Voltage/Frequency	AC: 120-240V, 50/60Hz	AC: 120-240V, 50/60Hz
Luminous Flux	2200lm	3400lm
Commercial Type	A120	A120
LED Type	SMD	SMD
CRI	> 80	> 80
PF	> 0.7	> 0.7
Beam Angle	150°D	150°D
Base	E27	E27
Body Type	Plastic Clad Aluminum	Plastic Clad Aluminum
Dimension	120mm x212mm	120mm x212mm



N/A
3800230628251
3800230628268



3800230628930
3800230628947
3800230628954

EAN Code 3000K
EAN Code 4500K
EAN Code 6000K





10W
VT-1853

4325 3000K Warmwhite
N/A 4500K Daywhite
N/A 6000K White

10W
VT-1853

4334 3000K Warmwhite
N/A 4500K Daywhite
4326 6000K White

Model No.	VT-1853	VT-1853
Watts	10W	10W
EQ. Watts	60W	60W
Voltage/Frequency	AC: 200-240V, 50Hz	AC: 200-240V, 50Hz
Luminous Flux	806lm	806lm
Commercial Type	A60	A60
LED Type	SMD	SMD
CRI	> 80	> 80
PF	> 0.5	> 0.5
Beam Angle	200'D	200'D
Base	E27	B22
Body Type	Thermal Plastic	Thermal Plastic
Dimension	60mm x108mm	60mm x 108mm
		
EAN Code 3000K	3800157601122	3800157601252
EAN Code 4500K	N/A	N/A
EAN Code 6000K	N/A	3800157601139



12W 4328 3000K Warmwhite
 N/A 4500K Daywhite
VT-1864 4329 6000K White

12W 4327 3000K Warmwhite
 N/A 4500K Daywhite
VT-1864 N/A 6000K White

Model No.	VT-1864	VT-1864
Watts	12W	12W
EQ. Watts	75W	75W
Voltage/Frequency	AC: 200-240V, 50Hz	AC: 200-240V, 50Hz
Luminous Flux	1055lm	1055lm
Commercial Type	A60	A60
LED Type	SMD	SMD
CRI	> 80	> 80
PF	> 0.7	> 0.7
Beam Angle	200°D	200°D
Base	B22	E27
Body Type	Thermal Plastic	Thermal Plastic
Dimension	60mm x 118mm	60mm x 118mm



EAN Code 3000K 3800157601153
 EAN Code 4500K N/A
 EAN Code 6000K 3800157601160



3800157601146
 N/A
 N/A



6W 4330 3000K Warmwhite
VT-1855 N/A 4500K Daywhite
N/A 6000K White

5W 1651 3000K Warmwhite
VT-1959 1652 4500K Daywhite
1653 6000K White



6W 4331 3000K Warmwhite
VT-1880 N/A 4500K Daywhite
N/A 6000K White

Model No.	VT-1855	VT-1959	VT-1880
Watts	6W	5W	6W
EQ. Watts	40W	35W	40W
Voltage/Frequency	AC: 220-240V, 50Hz	AC: 220-240V, 50Hz	AC: 220-240V, 50Hz
Luminous Flux	470lm	320lm	470lm
Commercial Type	Candle	Spotlight	P45
LED Type	SMD	SMD	SMD
CRI	> 80	> 80	> 80
PF	> 0.5	> 0.5	> 0.5
Beam Angle	180'D	38'D	180'D
Base	E14	GU10	E14
Body Type	Plastic	Glass	Plastic
Dimension	37mm x 103mm	50mm x55mm	45mm x80mm
			
EAN Code 3000K	3800157601177	3800157601214	3800157601184
EAN Code 4500K	N/A	3800157601221	N/A
EAN Code 6000K	N/A	3800157601238	N/A



4W 4333 3000K Warmwhite
VT-1986 N/A 4500K Daywhite
 N/A 6000K White

6W 4332 3000K Warmwhite
VT-1887 N/A 4500K Daywhite
 N/A 6000K White

Model No.	VT-1986	VT-1887
Watts	4W	6W
EQ. Watts	40W	60W
Voltage/Frequency	AC: 220-240V, 50 Hz	AC: 220-240V, 50Hz
Luminous Flux	400lm	550lm
Commercial Type	Candle	A60
LED Type	Filament	Filament
CRI	> 80	> 80
PF	> 0.4	> 0.5
Beam Angle	300°D	300°D
Base	E14	E27
Body Type	Glass	Glass
Dimension	35mm x 100mm	60mm x107mm
		
EAN Code 3000K	3800157601207	3800157601191
EAN Code 4500K	N/A	N/A
EAN Code 6000K	N/A	N/A

Accessories **Pendant for LED Bulbs**



Model No VT-7228
SKU Code 3475
Color Brown
Length 1000mm
Base E27
EAN Code 3800157607919



Model No VT-7228
SKU Code 3476
Color Blue
Length 1000mm
Base E27
EAN Code 3800157607926



Model No VT-7228
SKU Code 3477
Color White
Length 1000mm
Base E27
EAN Code 3800157607933



Model No VT-7228
SKU Code 3478
Color Black
Length 1000mm
Base E27
EAN Code 3800157607940



Model No VT-7228
SKU Code 3479
Color Pink
Length 1000mm
Base E27
EAN Code 3800157607957



Model No VT-7228
SKU Code 3480
Color Red
Length 1000mm
Base E27
EAN Code 3800157607964



Model No VT-7228
SKU Code 3481
Color Grey
Length 1000mm
Base E27
EAN Code 3800157607971

Converter Holder For LED Bulbs



B22-E14 Converter

SKU Code 3420



B22-E27 Converter

SKU Code 3419



E40-E27 Converter

SKU Code 3417

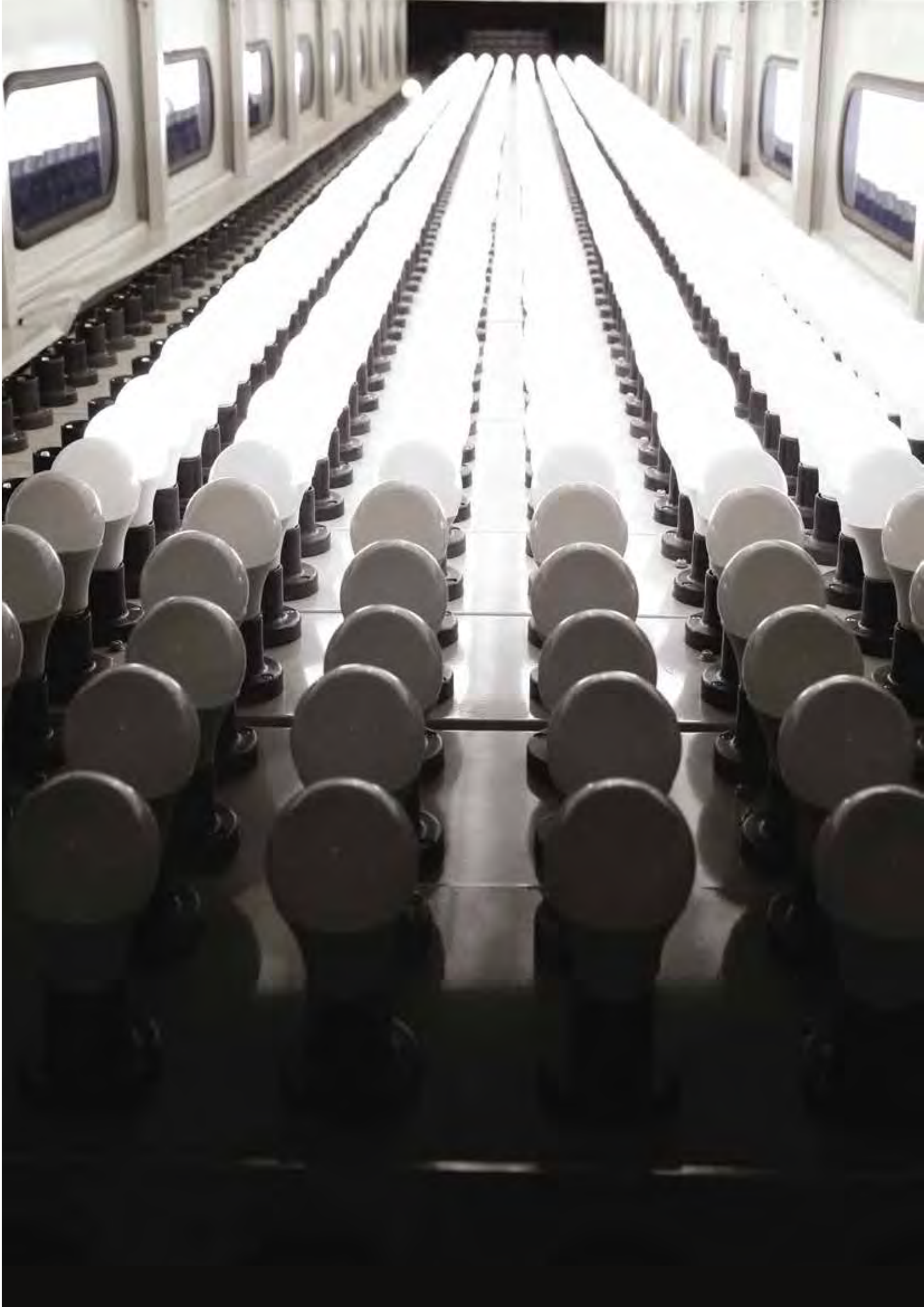



LED PAR BULBS & AR111

This versatile series great quality light source also boasts of an impressive hour lamp life which has a huge impact on replacement costs

PRODUCT FEATURES

- Eco friendly and Power Saving alternative for Standard Halogen Par Lamps with a longer life.
- Each lamp is a direct retrofit for a comparable Halogen Par Lamp e.g. AR111, PAR 30 & PAR 38
- Exceptional Heat Radiation Efficiency
- Non - Flickering
- No UV Radiation
- Easy Installation
- Premium Quality Power Driver
- Creates better Lighting effect than the old halogen bulb
- Dimmable & Non Dimmable options available

APPLICATIONS

- Widely used in Showrooms, Exhibition Stands, Stores, Offices and Reception areas, Hotels, Bars and Commercial Lighting



SMD
LED TYPE

40W
EQUIVALENT



8W
VT-1208

4263 3000K Warmwhite
 4264 4500K Daywhite
 4265 6000K White

SMD
LED TYPE

60W
EQUIVALENT



12W
VT-1212

4266 3000K Warmwhite
 4267 4500K Daywhite
 4268 6000K White





15W
VT-1216

4269 3000K Warmwhite
 4270 4500K Daywhite
 4271 6000K White



75W
EQUIVALENT

SMD
LED TYPE

Model No.	VT-1208	VT-1212	VT-1216
Watts	8W	12W	15W
EQ. Watts	40W	60W	75W
Voltage/Frequency	AC: 220-240V, 50Hz	AC: 220-240V, 50Hz	AC: 220-240V, 50Hz
Luminous Flux	450lm	750lm	1000lm
Commercial Type	PAR 20	PAR 30	PAR 38
LED Type	SMD	SMD	SMD
CRI	> 80	> 80	> 80
PF	> 0.5	> 0.5	> 0.5
Beam Angle	40'D	40'D	40'D
Base	E27	E27	E27
Body Type	Plastic	Plastic	Plastic
Dimension	63.5 x 83mm	95 x 114mm	120 x 132mm
			
EAN Code 3000K	3800230627483	3800230627513	3800230627544
EAN Code 4500K	3800230627490	3800230627520	3800230627551
EAN Code 6000K	3800230627506	3800230627537	3800230627568

 **IP65**



100W
EQUIVALENT

30°
BEAM ANGLE

E27

 **1200**
LUMENS
15W
VT-1125

4415 3000K WarmWhite
4416 4500K DayWhite
4417 6000K White

4418 Green
4419 Red
4420 Blue



Green



Red



Blue

Model No.	VT-1125
Watts	15W
EQ. Watts	100W
Voltage/Frequency	AC: 180-240V, 50/60Hz
Luminous Flux	1200lm
LED Type	SMD
Commercial Type	PAR38
CRI	> 80
PF	> 0.5
Beam Angle	30°D
Base	E27
Body Type	Plastic Coated Aluminum
IP Rating	IP65
Dimension	D:120 x 133mm

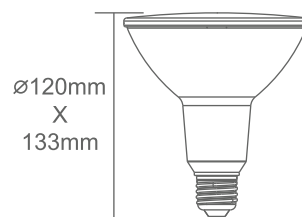
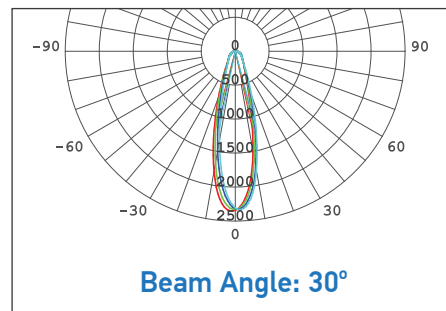

EAN Code 3000K 3800157606271
EAN Code 4500K 3800157606288
EAN Code 6000K 3800157606295

GREEN 3800157606301
RED 3800157606318
BLUE 3800157606325

ACCESSORIES FOR PAR BULBS



ABS
MATERIAL

E27

PAR 38
COMPATIBLE

IP44

VT-728

7044
Garden Spike
Single Head



ABS
MATERIAL

E27

PAR 38
COMPATIBLE

IP44

VT-729

7045
Garden Spike
Double Head

Model No.

Type

Suitable

Holder

Material

Color

IP Rating

Dimension

VT-728

Outdoor

VT-1125 Bulb

E27

ABC

Black

IP44

470 x 85 x 85mm

VT-729

Outdoor

VT-1125 Bulb

E27

ABC

Black

IP44

335 x 210 x 80mm

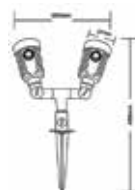
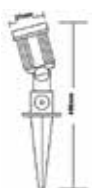

EAN Code

3800157606332

3800157606349



12W
VT-1112

4224 3000K Warmwhite
4223 4500K Daywhite
4225 6000K White



15W
VT-1110

4257 3000K Warmwhite
4256 4500K Daywhite
4255 6000K White



15W
VT-1110

4084 3000K Warmwhite
4062 4500K Daywhite
4061 6000K White



15W
VT-1110 D

4099 3000K Warmwhite
4106 4500K Daywhite
4086 6000K White



Model No.	VT-1112	VT-1110	VT-1110	VT-1110 D
Watts	12W	15W	15W	15W
EQ. Watts	60W	25W	25W	25W
Voltage/Frequency	AC: 200-240V, 50Hz	AC: 12V, 50Hz	AC: 12V, 50Hz	AC: 220V, 50Hz
Luminous Flux	650lm	780lm	780lm	780lm
Commercial Type	AR111	AR111	AR111	AR111
LED Type	COB	COB	COB	COB
CRI	> 80	> 80	> 80	> 80
PF	> 0.9	> 0.9	> 0.9	> 0.9
Beam Angle	40°D	40°D	20°D	20°D
Base	GU10	RECESSED GX53	RECESSED GX53	RECESSED GX53
Body Type	Plastic Clad Aluminum	Plastic Clad Aluminum	Plastic Clad Aluminum	Plastic Clad Aluminum
Dimension	111 x 91mm	111 x 86 x 63mm	111 x 86 x 63mm	111 x 86 x 63mm



EAN Code 3000K
EAN Code 4500K
EAN Code 6000K

3800230626257
3800230626219
3800230626264

3800230628664
3800230628657
3800230628640

3800230620064
3800230620057
3800230620040

3800230620088
3800230620071
3800230626486



COB
LED TYPE

100W
EQUIVALENT

1500
LUMENS

20W 1243 3000K WarmWhite
 1244 4500K DayWhite
VT-1120 1245 6000K White

20°
BEAM ANGLE

1500
LUMENS

20W 1246 3000K WarmWhite
 1247 4500K DayWhite
VT-1120 1248 6000K White

40°
BEAM ANGLE

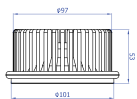
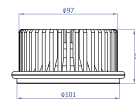
Model No.	VT-1120	VT-1120
Watts	20W	20W
EQ. Watts	100W	100W
Voltage/Frequency	AC: 220-240V, 50/60Hz	AC: 220-240V, 50/60Hz
Luminous Flux	1500lm	1500lm
LED Type	COB	COB
Commercial Type	AR111	AR111
CRI	> 80	> 80
PF	> 0.7	> 0.7
Beam Angle	20°D	40°D
Body Type	Die Cast Aluminum	Die Cast Aluminum
IP Rating	IP20	IP20
Dimension	D:111 x 61.5mm	D:111 x 61.5mm
Cutting Size	D:97mm 	D:97mm 
EAN Code 3000K	3800157606004	3800157606035
EAN Code 4500K	3800157606011	3800157606042
EAN Code 6000K	3800157606028	3800157606059

ACCESSORIES AR111



Model No.	VT-7221
SKU Code	3575
Color	White
Holder	1xAR111
Body Type	Aluminum
EAN Code	3800157604765



Model No.	VT-7221
SKU Code	3581
Color	Black
Holder	1xAR111
Body Type	Aluminum
EAN Code	3800157607063

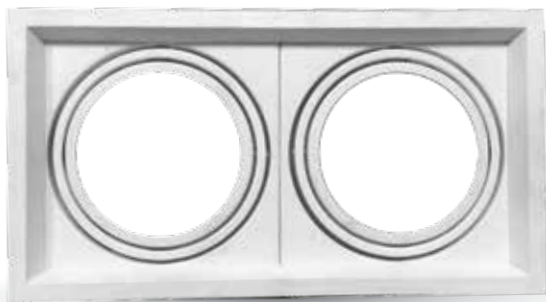

Model No.	VT-7222
SKU Code	3576
Color	White
Holder	2xAR111
Body Type	Aluminum
EAN Code	3800157604772



Model No.	VT-7222
SKU Code	3582
Color	Black
Holder	2xAR111
Body Type	Aluminum
EAN Code	3800157607070

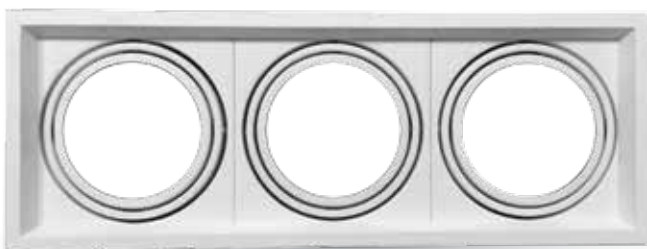

Model No.	VT-7223
SKU Code	3577
Color	White
Holder	3xAR111
Body Type	Aluminum
EAN Code	3800157604789



Model No.	VT-7223
SKU Code	3583
Color	Black
Holder	3xAR111
Body Type	Aluminum
EAN Code	3800157607087





LED TUBES

Transform your existing space and make it more sustainable, beautify it with an even glow and make it safe with NO mercury. V-TAC LED Tube Series perfectly fit into existing linear fixtures and provide comparably better light levels to current Linear fluorescent systems .

PRODUCT FEATURES

- Cost effective, safe retrofit for T8 Tubes
- Perfectly matches with the traditional daylight tube fixture
- Easy Installation
- No Lead or Mercury content hence Environment friendly
- No Ultraviolet or Infrared rays
- Non - flickering
- Long Lifespan, Low maintenance and energy saving
- Available in 60 cm, 120 cm, 150 cm & 180 cm
- Ballast or Starter NOT REQUIRED – DIRECT AC POWER

APPLICATIONS

- Widely used for Domestic and Commercial Lighting, Offices, Supermarkets, Shops, Hotels & similar environment



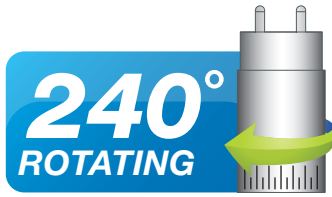

10W **60CM**
VT-6272 SIZE

6148 3000K Warmwhite
6153 4500K Daywhite
6144 6000K White

14W **90CM**
VT-9272 SIZE

N/A 3000K Warmwhite
6146 4500K Daywhite
6147 6000K White

18W **120CM**
VT-1272 SIZE

6149 3000K Warmwhite
6140 4500K Daywhite
6141 6000K White

22W **150CM**
VT-1572 SIZE

6150 3000K Warmwhite
6142 4500K Daywhite
6143 6000K White

Model No.	VT-6272	VT-9272	VT-1272	VT-1572
Watts	10W	14W	18W	22W
EQ. Watts	18W	25W	36W	55W
Voltage/Frequency	AC:220-240V, 50Hz	AC: 200-240V, 50Hz	AC: 220-240V, 50Hz	AC: 220-240V, 50Hz
Luminous Flux	800lm	1200lm	1600lm	1900lm
LED Chip	SMD	SMD	SMD	SMD
CRI	>80	>80	>80	>80
PF	> 0.5	> 0.5	> 0.5	> 0.5
Beam Angle	240°D	240°D	240°D	240°D
Body Type	Glass	Glass	Glass	Glass
IP Rating	IP20	IP20	IP20	IP20
Dimension	28mm x 600mm	28mm x 900mm	28mm x 1200mm	28mm x 1500mm

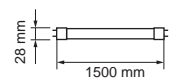
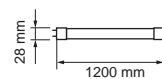
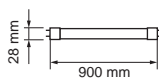
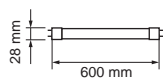

EAN Code 3000K
EAN Code 4500K
EAN Code 6000K

3800230627681
3800230627940
3800230627162

N/A
3800230627315
3800230627322

3800230627698
3800230626707
3800230626714

3800230627704
3800230626721
3800230626738

LED TUBES

GLASS NON-ROTATION

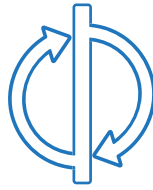

NON-ROTATABLE



10W **60CM**
VT-6272 SIZE

6204 3000K Warmwhite
6210 4500K Daywhite
6211 6000K White

14W **90CM**
VT-9272 SIZE

N/A 3000K Warmwhite
6234 4500K Daywhite
6235 6000K White

18W **120CM**
VT-1272 SIZE

6205 3000K Warmwhite
6208 4500K Daywhite
6206 6000K White

22W **150CM**
VT-1572 SIZE

6207 3000K Warmwhite
6212 4500K Daywhite
6213 6000K White

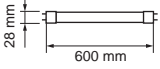
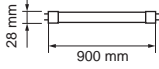
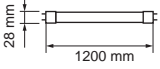
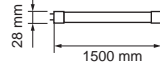
Model No.	VT-6272	VT-9272	VT-1272	VT-1572
Watts	10W	14W	18W	22W
Eq Watts	18W	25W	36W	58W
Voltage	AC:220-240V,50Hz	AC:220-240V,50Hz	AC:220-240V,50Hz	AC:220-240V,50Hz
Lumens	800lm	1200lm	1600lm	2000lm
LED Type	SMD	SMD	SMD	SMD
CRI	>80	>80	>80	>80
PF	>0.5	>0.5	>0.5	>0.5
Beam Angle	160'D	160'D	160'D	160'D
Body Type	Glass	Glass	Glass	Glass
On/off	>10000	>10000	>10000	>10000
IP Rating	IP20	IP20	IP20	IP20
Dimension	28mm x 600mm 	28mm x 900mm 	28mm x 1200mm 	28mm x 1500mm 
EAN Code 3000K	3800157604185	N/A	3800157604192	3800157604215
EAN Code 4500K	3800157604406	3800157607117	3800157604307	3800157604420
EAN Code 6000K	3800157604413	3800157607124	3800157604208	3800157604437



18W 6223 3000K Warmwhite
VT-1288 6224 4500K Daywhite
 6225 6000K White

120CM
 SIZE



120⁺⁺ LM/W
HIGH LUMENS



24W 6226 3000K Warmwhite
VT-1588 6227 4500K Daywhite
 6228 6000K White

150CM
 SIZE

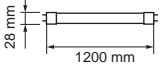
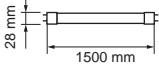

120⁺⁺ LM/W
HIGH LUMENS

Model No.	VT-1288	VT-1588
Watts	18W	24W
Eq Watts	45W	75W
Voltage	AC:220-240V,50Hz	AC:220-240V,50Hz
Lumens	2300lm	3000lm
LED Type	SMD	SMD
CRI	>80	>80
PF	>0.5	>0.5
Beam Angle	160'D	160'D
Body Type	Glass	Glass
On/off	>10000	>10000
IP Rating	IP20	IP20
Dimension	28mm x 1200mm 	28mm x 1500mm 
EAN Code 3000K	3800157605151	3800157605182
EAN Code 4500K	3800157605168	3800157605199
EAN Code 6000K	3800157605175	3800157605205

LED TUBES PLASTIC ROTATION



10W
VT-6072

6229 3000K Warmwhite
6230 4500K Daywhite
6231 6000K White

60CM
SIZE

240°
ROTATING
IN PLASTIC

Model No.	VT-6072
Watts	10W
Eq Watts	18W
Voltage	AC:220-240V,50Hz
Lumens	800lm
LED Type	SMD
CRI	>80
PF	>0.5
Beam Angle	160°D
Body Type	Plastic
On/off	>10000
IP Rating	IP20
Dimension	28mm x 600mm

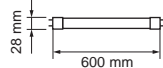

EAN Code 3000K	3800157605212
EAN Code 4500K	3800157605229
EAN Code 6000K	3800157605236



10W
VT-6070 SMD

N/A 3000K Warmwhite
6126 4500K Daywhite
6127 6000K White

60CM
SIZE



18W
VT-1270 SMD

N/A 3000K Warmwhite
6122 4500K Daywhite
6123 6000K White

120CM
SIZE



22W
VT-1570 SMD

N/A 3000K Warmwhite
6124 4500K Daywhite
6125 6000K White

150CM
SIZE



40W
VT-1840

N/A 3000K Warmwhite
6250 4500K Daywhite
6251 6000K White

180CM
SIZE



Model No.	VT-6070 SMD	VT-1270 SMD	VT-1570 SMD	VT-1840
Watts	10W	18W	22W	40W
EQ. Watts	25W	45W	55W	80W
Voltage/Frequency	AC:100-240V, 50Hz	AC: 100-240V, 50Hz	AC: 170-240V, 50Hz	AC:85-265V,50Hz
Luminous Flux	850lm	1600lm	2000lm	3600lm
LED Type	SMD	SMD	SMD	SMD
CRI	>80	>80	>80	>80
PF	> 0.8	> 0.8	> 0.8	>0.9
Beam Angle	270'D	270'D	270'D	120'D
Body Type	Thermal Plastic	Thermal Plastic	Thermal Plastic	Aluminum+PC
IP Rating	IP20	IP20	IP20	IP20
Dimension	26mm x 600mm	26mm x 1200mm	26mm x1500mm	28mm x 1800mm

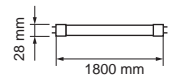
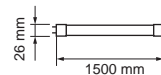
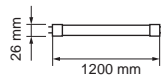
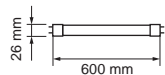

EAN Code 3000K
EAN Code 4500K
EAN Code 6000K

N/A
3800230623508
3800230623515

N/A
3800230623522
3800230623539

N/A
3800230623546
3800230623553

N/A
3800157607834
3800157607841

LED TUBE FIXTURES PRISMATIC FITTINGS

**SUPER
SLIM**



10W
VT-8013 **30CM**
SIZE

4987 3000K Warmwhite
4988 4500K Daywhite
4989 6000K White

20W
VT-8020 **60CM**
SIZE

4990 3000K Warmwhite
4991 4500K Daywhite
4992 6000K White

40W
VT-8040 **120CM**
SIZE

4993 3000K Warmwhite
4994 4500K Daywhite
4995 6000K White

40W
VT-8040 **120CM**
SIZE

5080 3000K Warmwhite
5061 4500K Daywhite
5060 6000K White

Model No.	VT-8013	VT-8020	VT-8040	VT-8040
Watts	10W	20W	40W	40W
EQ. Watts	50W	100W	200W	200W
Voltage/Frequency	AC:200-240V,50Hz	AC:200-240V,50Hz	AC:200-240V,50Hz	AC:200-240V,50Hz
Luminous Flux	800lm	1600lm	3200lm	3200lm
LED Chip	SMD	SMD	SMD	SMD
CRI	>80	>80	>80	>80
PF	>0.9	>0.9	>0.9	>0.9
Beam Angle	110°D	110°D	110°D	110°D
Body Type	Aluminum+Plastic	Aluminum+Plastic	Aluminum+Plastic	Iron+Plastic
IP Rating	IP20	IP20	IP20	IP20
Dimension	300 x 75 x 25mm	600 x 75 x 25mm	1200 x 75 x 25mm	1200 x 75 x 25mm

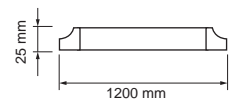
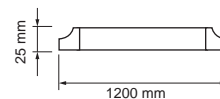
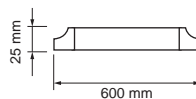
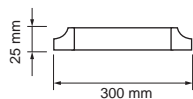

EAN Code 3000K
EAN Code 4500K
EAN Code 6000K

3800157601955
3800157601962
3800157601979

3800157601986
3800157601993
3800157602006

3800157602013
3800157602020
3800157602037

3800157608329
3800157605960
3800157605953



16W
VT-8011

60CM
SIZE

4974 3000K Warmwhite
4975 4500K Daywhite
4976 6000K White

32W
VT-8012

120CM
SIZE

4977 3000K Warmwhite
4978 4500K Daywhite
4979 6000K White

Model No.	VT-8011	VT-8012
Watts	16W	32W
EQ. Watts	40W	80W
Voltage/Frequency	AC: 200-240V,50/60Hz	AC: 200-240V,50/60Hz
Luminous Flux	1200lm	2400lm
LED Chip	SMD	SMD
CRI	>80	>80
PF	> 0.9	> 0.9
Beam Angle	110°D	110°D
Body Type	Plastic	Plastic
IP Rating	IP20	IP20
Dimension	600 x 135 x 46mm	1200 x 135 x 46mm

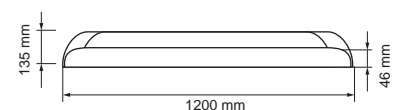
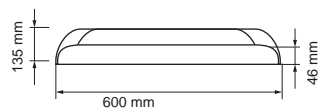

EAN Code 3000K
EAN Code 4500K
EAN Code 6000K

[3800230629470](#)
[3800230629487](#)
[3800230629494](#)

[3800230629500](#)
[3800230629517](#)
[3800230629524](#)

LED TUBE FIXTURES LINEAR LIGHT



36W
VT-12042

120CM
SIZE

N/A 3000K Warmwhite
6202 4500K Daywhite
6203 6000K White

8071 Joint
8072 Wire

Model No.	VT-12042
Watts	36W
EQ. Watts	80W
Voltage/Frequency	AC85-265V/50-60Hz
Luminous Flux	2900lm
LED Chip	SMD
CRI	>80
PF	>0.9
Beam Angle	120°D
Body Type	IRON+PC
IP Rating	IP20
Dimension	1187 x 54 x 36mm

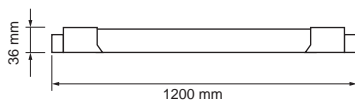

EAN Code 3000K **N/A**
EAN Code 4500K **3800157604024**
EAN Code 6000K **3800157604031**

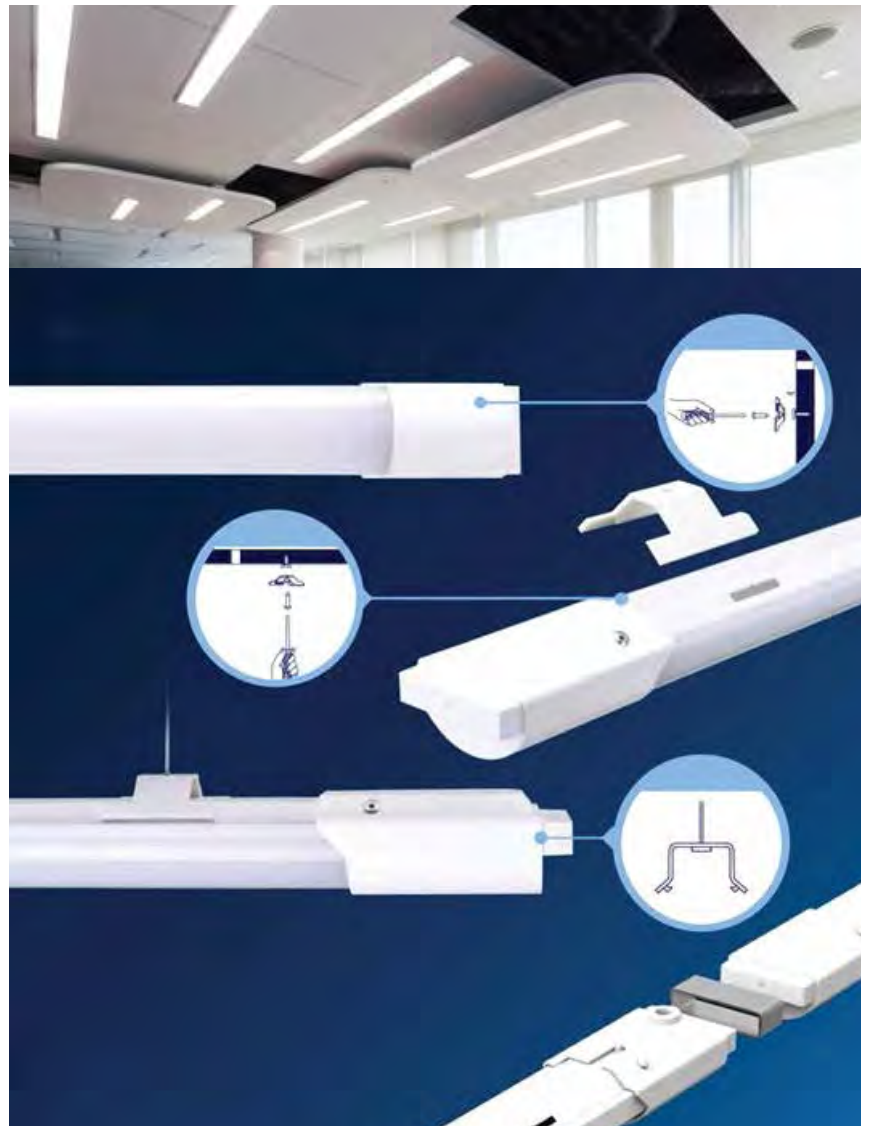

**T5 TUBE
 WITH FITTING**



4W
VT-3033

30CM
 SIZE

6166 3000K Warmwhite
 6167 4500K Daywhite
 6168 6000K White

7W
VT-6073

60CM
 SIZE

6169 3000K Warmwhite
 6170 4500K Daywhite
 6171 6000K White

14W
VT-1273

120CM
 SIZE

6172 3000K Warmwhite
 6173 4500K Daywhite
 6174 6000K White

Model No.	VT-3033	VT-6073	VT-1273
Watts	4W	7W	14W
EQ. Watts	8W	14W	28W
Voltage/Frequency	AC:200~240V, 50/60Hz	AC:200~240V, 50/60Hz	AC:200~240V, 50/60Hz
Luminous Flux	330lm	630lm	1260 lm
LED Chip	SMD	SMD	SMD
CRI	>80	>80	>80
PF	> 0.5	> 0.9	> 0.9
Beam Angle	141'D	141'D	141'D
Body Type	Plastic	Plastic	Plastic
IP Rating	IP20	IP20	IP20
Dimension	300 x 25mm	600 x 25mm	1200 x 25mm

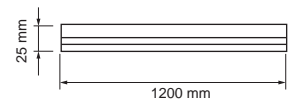
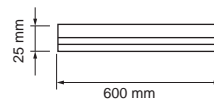
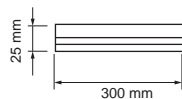

EAN Code 3000K [3800230629159](#)
 EAN Code 4500K [3800230629166](#)
 EAN Code 6000K [3800230629173](#)

[3800230629180](#)
[3800230629197](#)
[3800230629203](#)

[3800230629210](#)
[3800230629227](#)
[3800230629234](#)

LED TUBE FIXTURES WATER-PROOF FITTINGS



18W
VT-6048



N/A 3000K Warmwhite
6198 4500K Daywhite
6199 6000K White



20W
VT-6020



N/A 3000K Warmwhite
N/A 4500K Daywhite
6175 6000K White



40W
VT-6040



N/A 3000K Warmwhite
N/A 4500K Daywhite
6154 6000K White



Model No.	VT-6048	VT-6020	VT-6040
Watts	18W	20W	40W
EQ. Watts	60W	50W	100W
Voltage/Frequency	AC:200-240V,50Hz	AC:200~240V, 50/60Hz	AC:200~240V, 50/60Hz
Luminous Flux	1400lm	1600 lm	3200 lm
LED Type	SMD	SMD	SMD
CRI	>70	>70	>70
PF	>0.9	> 0.9	> 0.9
Beam Angle	120'D	120'D	120'D
Body Type	Plastic	Aluminum+Plastic	Aluminum+Plastic
IP Rating	IP65	IP65	IP65
Dimension	600 x 86 x 70mm	600 x 86 x 70mm	600 x 86 x 70mm

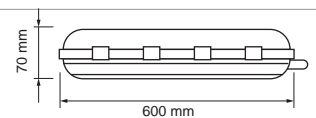
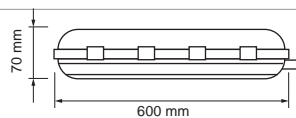
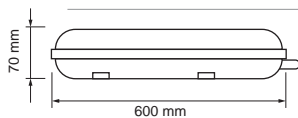

EAN Code 3000K
EAN Code 4500K
EAN Code 6000K

N/A
3800157603256
3800157603263

N/A
N/A
3800157600903

N/A
N/A
3800230628473



36W
VT-1248 N/A 3000K Warmwhite
6200 4500K Daywhite
6201 6000K White

120CM
SIZE

IP65
TESTED & APPROVED



40W
VT-1240 SMD N/A 3000K Warmwhite
6178 4500K Daywhite
6061 6000K White

120CM
SIZE

IP65
TESTED & APPROVED



60W
VT-1260 SMD N/A 3000K Warmwhite
6179 4500K Daywhite
6062 6000K White

120CM
SIZE

IP65
TESTED & APPROVED

Model No.	VT-1248	VT-1240 SMD	VT-1260 SMD
Watts	36W	40W	60W
EQ. Watts	120W	72W	150W
Voltage/Frequency	AC:200-240V,50Hz	AC: 200-240V, 50 Hz	AC: 200-240V, 50Hz
Luminous Flux	2800lm	3600lm	5100 - 5300lm
LED Type	SMD	SMD	SMD
CRI	>70	> 70	>70
PF	>0.9	> 0.9	> 0.9
Beam Angle	120°D	120°D	120°D
Body Type	Plastic	Plastic + Aluminium	Plastic + Aluminium
IP Rating	IP65	IP65	IP65
Dimension	1200 x 86 x 70mm	1200 x 86 x 70mm	1200 x 86 x 70mm

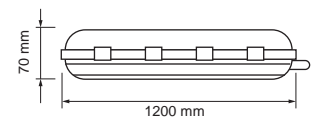
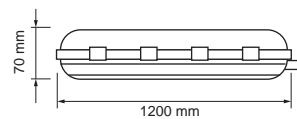
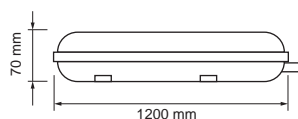

EAN Code 3000K
EAN Code 4500K
EAN Code 6000K

N/A
3800157603270
3800157603287

N/A
3800157601603
3800230625205

N/A
3800157601610
3800230625212

LED TUBE FIXTURES WATER-PROOF FITTING



48W N/A 3000K Warmwhite
VT-1548 6184 4500K Daywhite
6185 6000K White

150CM
SIZE



50W N/A 3000K Warmwhite
VT-1551 6177 4500K Daywhite
6176 6000K White

150CM
SIZE



70W N/A 3000K Warmwhite
VT-1571 6180 4500K Daywhite
6145 6000K White

150CM
SIZE



Model No.	VT-1548	VT-1551	VT-1571
Watts	48W	50W	70W
EQ. Watts	90W	110W	140W
Voltage/Frequency	AC85-265V/50-60Hz	AC:200-240V,50Hz	AC:200~240V, 50/60Hz
Luminous Flux	4000lm	4500lm	6300lm
LED Type	SMD	SMD	SMD
CRI	>75	>70	>70
PF	>0.9	>0.9	> 0.9
Beam Angle	120'D	120'D	120'D
Body Type	Plastic	Plastic	Plastic + Aluminium
IP Rating	IP65	IP65	IP65
Dimension	1480 x 86 x 72mm	1500 x 86 x 70mm	1500 x 86 x 70mm

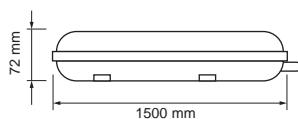

N/A
3800157602389
3800157602396

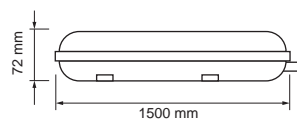

N/A
3800157601597
3800157601580

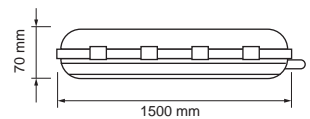

N/A
3800157601627
3800230627278

EAN Code 3000K
EAN Code 4500K
EAN Code 6000K



10W
VT-8112

5068 3000K Warmwhite
 5069 4500K Daywhite
 5070 6000K White

60CM
 SIZE

Model No.	VT-8112
Watts	10W
Eq Watts	50W
Voltage	AC:220-240V,50/60Hz
Lumens	800lm
LED Type	SMD
CRI	>80
PF	>0.9
Beam Angle	110°D
Body Type	Aluminum body,plastic diffuser
IP Rating	IP20
Dimension	579x78x35mm

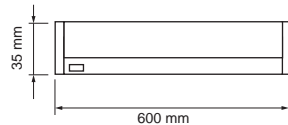

EAN Code 3000K
 EAN Code 4500K
 EAN Code 6000K

[3800157606714](#)
[3800157606721](#)
[3800157606738](#)

LED TUBE FIXTURES WALL FITTING



10W
VT-8111

60CM
SIZE

5071 3000K Warmwhite
5072 4500K Daywhite
5073 6000K White

20W
VT-8121

120CM
SIZE

5074 3000K Warmwhite
5075 4500K Daywhite
5076 6000K White

Model No.

Watts

EQ. Watts

Voltage/Frequency

Luminous Flux

LED Type

CRI

PF

Beam Angle

Body Type

IP Rating

Dimension

VT-8111

10W

20W

AC:85-265V,50/60Hz

900lm

SMD

>80

>0.9

120°D

Aluminum+PC

IP20

600 x 32mm

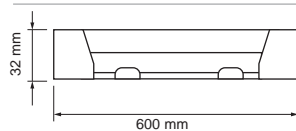

VT-8121

20W

40W

AC:85-265V,50/60Hz

1800lm

SMD

>80

>0.9

120°D

Aluminum+PC

IP20

1200x32mm

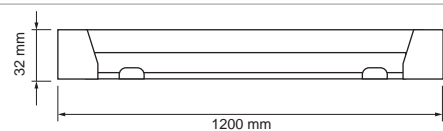

EAN Code 3000K
EAN Code 4500K
EAN Code 6000K

[3800157606745](#)
[3800157606752](#)
[3800157606769](#)

[3800157606776](#)
[3800157606783](#)
[3800157606790](#)

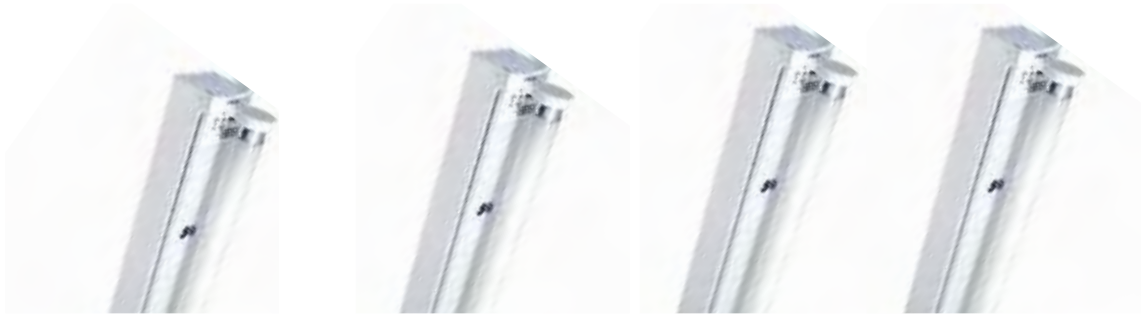

MODEL No.	VT-16010	VT-12020	VT-15020	VT-18011
SKU Code	6052	6054	6056	6151
Body Type	Aluminum	Aluminum	Aluminum	Aluminum
IP Rating	IP20	IP20	IP20	IP20
Size	600mm	1200mm	1500mm	1800mm
EAN Code	3800230624642	3800230624666	3800230624680	3800230627926



MODEL No.	VT-16011	VT-12021	VT-15021
SKU Code	6053	6055	6057
Body Type	Aluminum	Aluminum	Aluminum
IP Rating	IP20	IP20	IP20
Size	600mm x 2	1200mm x 2	1500mm x 2
EAN Code	3800230624659	3800230624673	3800230624697

Batten Fixtures for our T8 LED Tubes so they can be used in a variety of different applications such as public areas like hotels, restaurants or hospitals.



LED PANELS

Uniform radiance coupled with consistent illumination and zero hot or cold spots, just pure systematic radiance with the V-TAC LED Light Panels. Practical, Economical and friendly

PRODUCT FEATURES

- Ultra Slim Design
- Contemporary & Elegant Design
- Higher Light Transmission Rate
- Exterior shell, cannot be easily damaged
- No infrared, does not attract flies
- Easy to install
- No Lead or Mercury content hence Environment friendly
- Dimmable options available in selected models

APPLICATIONS

- Office Lighting (Conference Room, Hospitals, Hotels, Shopping Malls, Showroom and lobby cabin etc.) Kitchen and Domestic Lighting





45W
VT-6060 6028 3000K Warmwhite
6024 4500K Daywhite
6025 6000K White

595 x 595
SIZE

3600
LUMENS

150W
EQUIVALENT

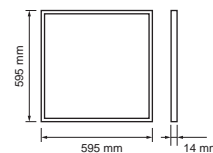

45W
VT-6068 60289 / 6220 3000K Warmwhite
60249 / 6218 4500K Daywhite
60259 / 6219 6000K White

595 x 595
SIZE

3600
LUMENS

150W
EQUIVALENT

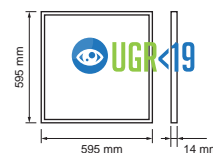

45W
VT-6060 60286 3000K Warmwhite
60246 4500K Daywhite
60256 6000K White

595 x 595
SIZE

3600
LUMENS

150W
EQUIVALENT



DRIVERS FOR PANELS (EMC APPROVED)

SKU	6004	6019	6029	60199	} Compatible with 60289 / 6220 60249 / 6218 60259 / 6219
TYPE	NON-DIMMABLE	DIMMABLE	TRIDONIC	DIMMABLE	
POWER	45W	45W	45W	45W	
EAN CODE	3800230628275	3800157604017	N/A	N/A	

Model No.	VT-6060	VT-6068	VT-6060
Watts	45W	45W	45W
EQ. Watts	150W	150W	150W
Voltage/Frequency	DC:30-42V,50Hz	DC:30-42V,50Hz	DC:30-42V,50Hz
Luminous Flux	3600lm	3600lm	3600lm
LED Type	SMD	SMD	SMD
CRI	>80	>80	>80
PF	> 0.9	> 0.9	> 0.9
Beam Angle	120'D	120'D	120'D
Body Type	Aluminum+PMMA+PS	Aluminum+PMMA+PS	Aluminum+PMMA+PS
Shape	Square	Square	Square
Dimension	595 x 595 x14mm	595 x 595 x14mm	595 x 595 x14mm

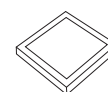
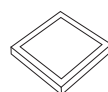
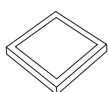

EAN Code 3000K [3800230624482](#)
EAN Code 4500K [3800230623652](#)
EAN Code 6000K [3800230623584](#)

[3800157604895](#)
[3800157604864](#)
[3800157604871](#)

[3800157608299](#)
[3800157608305](#)
[3800157608312](#)



45W
VT-6069

6222 3000K WarmWhite
6217 4500K DayWhite
6221 6000K White

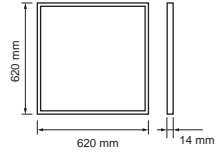

45W
VT-6062

6083 3000K WarmWhite
6063 4500K DayWhite
6084 6000K White

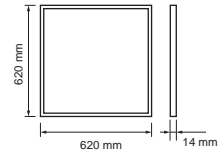

DRIVERS FOR PANELS (EMC APPROVED)

SKU	6004	6019	6029	60199	} Compatible with 6222 6217 6221
TYPE	NON-DIMMABLE	DIMMABLE	TRIDONIC	DIMMABLE	
POWER	45W	45W	45W	45W	
EAN CODE	3800230628275	3800157604017	N/A	N/A	

Model No.

Watts

EQ. Watts

Voltage/Frequency

Luminous Flux

LED Type

CRI

PF

Beam Angle

Body Type

Shape

Dimension

VT-6069

45W

150W

DC:30-42V,50Hz

3600lm

SMD

>80

>0.9

120°D

Aluminum+PMMA+PS

Square

620 x 620 x14mm

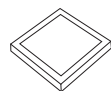

VT-6062

45W

150W

DC:30-42V,50Hz

3600lm

SMD

>80

> 0.9

120°D

Aluminum+PMMA+PS

Square

620 x 620 x14mm

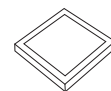

EAN Code 3000K
EAN Code 4500K
EAN Code 6000K

3800157604918
3800157604857
3800157604901

3800157601481
3800230625571
3800157601498



29W
VT-6129

6240 3000K WarmWhite
6241 4500K DayWhite
6242 6000K White

120⁺⁺
LM/W
HIGH
LUMENS

595 x 595
SIZE

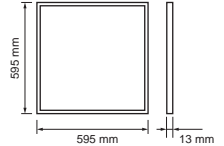

3600
LUMENS

150W
EQUIVALENT



45W
VT-6145

N/A 3000K WarmWhite
6236 4500K DayWhite
6237 6000K White

120⁺⁺
LM/W
HIGH
LUMENS

595 x 595
SIZE

5400
LUMENS

250W
EQUIVALENT

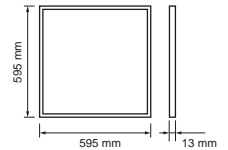

Model No.

VT-6129

VT-6145

Watts

29W

45W

EQ. Watts

150W

250W

Voltage/Frequency

AC:220-240V,50/60Hz

AC:220-240V,50/60Hz

Luminous Flux

3600lm

5400lm

LED Type

SMD

SMD

CRI

>80

>80

PF

>0.9

>0.9

Beam Angle

120'D

120'D

Body Type

Aluminum+PMMA+PC

Aluminum+PMMA+PC

Shape

Square

Square

Dimension

595 x 595 x13mm

595 x 595 x13mm

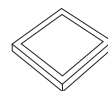
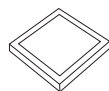

EAN Code 3000K
EAN Code 4500K
EAN Code 6000K

3800157608169
3800157608176
3800157608183

N/A
3800157607612
3800157607629



36W
VT-6136

N/A 3000K WarmWhite
6238 4500K DayWhite
6239 6000K White

120⁺⁺
LM/W
HIGH
LUMENS

595 x 595
SIZE

4320
LUMENS

180W
EQUIVALENT

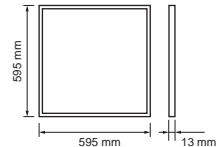

36W
VT-6137

N/A 3000K WarmWhite
6243 4500K DayWhite
N/A 6000K White

120⁺⁺
LM/W
HIGH
LUMENS

620 x 620
SIZE

4320
LUMENS

180W
EQUIVALENT

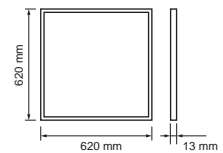

DIMMABLE DRIVER COMPATIBLE

Model No.	VT-6136	VT-6137
Watts	36W	36W
EQ. Watts	180W	180W
Voltage/Frequency	AC:220-240V,50/60Hz	AC:220-240V,50/60Hz
Luminous Flux	4320lm	4320lm
LED Type	SMD	SMD
CRI	>80	>80
PF	>0.9	>0.9
Beam Angle	120'D	120'D
Body Type	Aluminum+PMMA+PC	Aluminum+PMMA+PC
Shape	Square	Square
Dimension	595 x 595 x 13mm	620 x 620 x 13mm

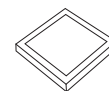
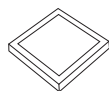

EAN Code 3000K
EAN Code 4500K
EAN Code 6000K

N/A
3800157607636
3800157607643

N/A
3800157608190
N/A



IP54



42W
VT-6042

N/A 3000K WarmWhite
 6232 4500K DayWhite
 6233 6000K White

595 x 595
 SIZE

4320
 LUMENS

180W
 EQUIVALENT

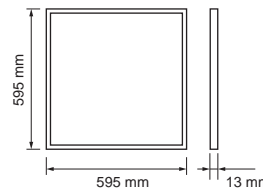

MODEL No	VT-6042
WATTS	42W
EQ. Watts	180W
Voltage/Frequency	AC:220-240V,50/60Hz
Luminous Flux	4320lm
LED Type	SMD
CRI	>80
PF	>0.9
Beam Angle	120'D
Body Type	Aluminum+PMMA+PC
Shape	Square
Dimension	595 x 595 x 13mm

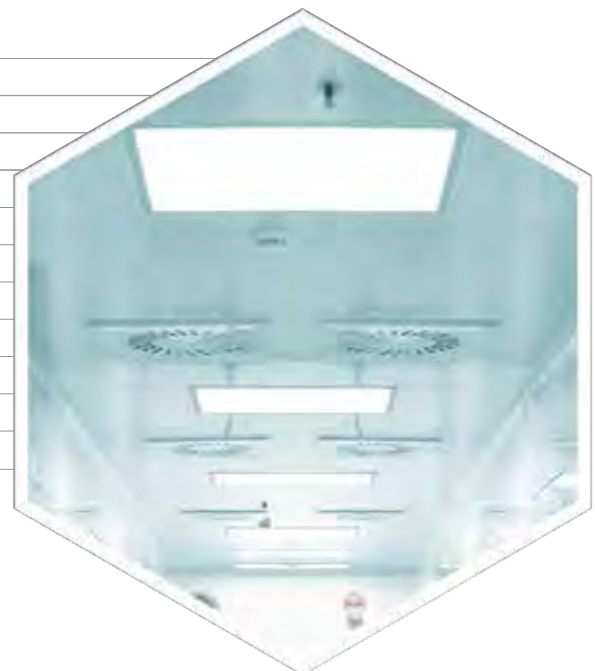
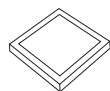

EAN Code 3000K
 EAN Code 4500K
 EAN Code 6000K

N/A
 3800157607094
 3800157607100

45W

VT-12030

6069 3000K Warmwhite
6026 4500K Daywhite
6027 6000K White

1195 x 295
SIZE

3600
LUMENS

150W
EQUIVALENT

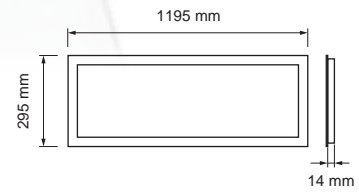

DRIVERS FOR PANELS (EMC APPROVED)

SKU	6004	6019	6029
TYPE	NON-DIMMABLE	DIMMABLE	TRIDONIC
POWER	45W	45W	45W
EAN CODE	3800230628275	3800157604017	N/A

Model No.

VT-12030

Watts	45W
EQ. Watts	150W
Voltage/Frequency	DC:30-42V,50Hz
Luminous Flux	3600lm
LED Type	SMD
CRI	>80
PF	> 0.9
Beam Angle	120°D
Body Type	Aluminum+PMMA+PS
Shape	Rectangle
Dimension	1195 x 295 x14mm

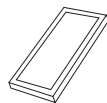

EAN Code 3000K	3800230628466
EAN Code 4500K	3800230623638
EAN Code 6000K	3800230623621



72W
VT-12060

6066 3000K Warmwhite
 6067 4500K Daywhite
 6068 6000K White

1195 x 595
 SIZE

5700
 LUMENS

210W
 EQUIVALENT

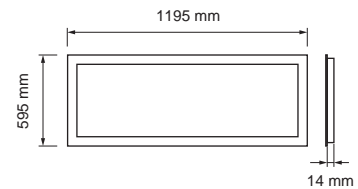

DRIVERS FOR PANELS

SKU	6047	6088
TYPE	EMC APPROVED -NON DIMMABLE	EMC APPROVED - DIMMABLE
POWER	72W	72W
EAN CODE	3800230627803	3800157602334

Model No.	VT-12060
Watts	72W
EQ. Watts	210W
Voltage/Frequency	AC: 170-240V, 50Hz
Luminous Flux	5700lm
LED Type	SMD 2835
CRI	>80
PF	> 0.9
Beam Angle	120'D
Body Type	Aluminum+PMMA+PS
Shape	Rectangle
Dimension	1195 x 595 x 14mm

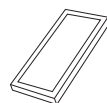

EAN Code 3000K	3800230627773
EAN Code 4500K	3800230627780
EAN Code 6000K	3800230627797

DALI Multi-current Driver



Model No VT-24045
SKU Code 3103
Voltage 20-39V -1050mp
Watts/ 40W/45W
EAN Code 3800157606837
Dimension

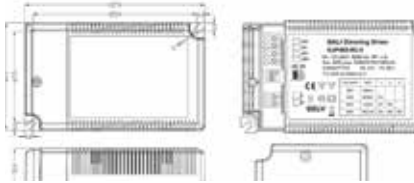

DALI Master



Model No VT-24050
SKU Code 3104
Watts <10W
EAN Code 3800157606844
Dimension

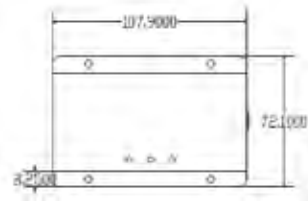

DALI Touch Panel Controller



Model No VT-24049
SKU Code 3105
Watts 0.1W
EAN Code 3800157606851
Dimension

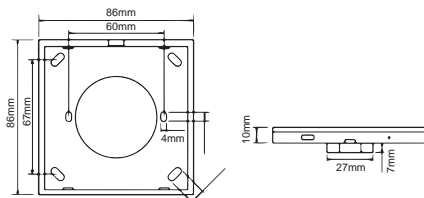

DALI Bus Power Supply



Model No VT-24048
SKU Code 3106
Watts 4W
EAN Code DALI POWER SUPPLY

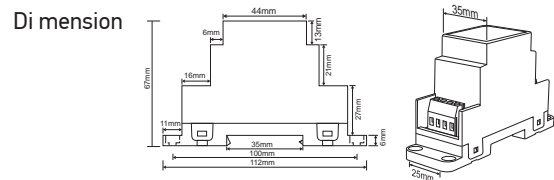



30W
VT-6041

6094 3000K Warmwhite
6095 4500K Daywhite
6096 6000K White



2400
LUMENS

90W
EQUIVALENT

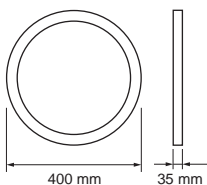

36W
VT-6051

6097 3000K Warmwhite
6098 4500K Daywhite
6099 6000K White



2880
LUMENS

110W
EQUIVALENT

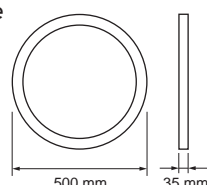

36W
VT-6050

6091 3000K Warmwhite
6092 4500K Daywhite
6093 6000K White

500 x 500
SIZE

2880
LUMENS

80W
EQUIVALENT

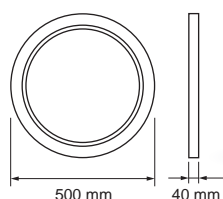

Model No.	VT-6041	VT-6051	VT-6050
Watts	30W	36W	36W
EQ. Watts	90W	110W	110W
Voltage/Frequency	AC:100-265V,50/60Hz	AC:100-265V,50/60Hz	AC:100-265V,50/60Hz
Luminous Flux	2400lm	2880lm	2880lm
LED Type	SMD	SMD	SMD
CRI	>80	>80	>80
PF	>0.9	>0.9	>0.9
Beam Angle	120°D	120°D	120°D
Body Type	Die Cast Aluminum	Die Cast Aluminum	Die Cast Aluminum
Shape	Round	Round	Round
Dimension	Φ400mm x 35mm	Φ500mm x 35mm	Φ500mm x 40mm



EAN Code 3000K
EAN Code 4500K
EAN Code 6000K

3800157604079
3800157604088
3800157604093

3800157604109
3800157604116
3800157604123

3800157604048
3800157604055
3800157604062

In order to make the slim panels more compatible, V-TAC has developed accessories so that the products can be installed in different types of option. This allows all our panels to be installed in three different types as required by the clients. They are :

- Recessed type
- Suspended mounted
- Surface mounted

Below are the accessories which support in making this type of installation possible



SUSPENDED MOUNTING FOR PANELS
 PRODUCT SKU : 6018
 EAN CODE: 3800230623669



This product can be used for all sizes of panels , that is

- 300 x 300
- 600 x 600
- 1200 x 300
- 1200 x 600

EMERGENCY PACK



13W SKU Code 7038
VT-513 Suitable for 45W LED Panels,
 VT-6060, VT-6062

Voltage	AC: 65-265V,50/60Hz
Charging Time	30 Hours
Working Time	≥3 HOURS
Battery Capacity	Ni-cd 12V 3000AH
Body Type	Metal
Size	215x113x48mm

Case for External mounting for panels



Mounting for 1200x 600
 Product SKU: 9989

Mounting for 620x 620
 Product SKU: 9997



Case for External mounting for panels



Mounting for 300 x 300
 Product SKU: 9970
 EAN Code: 3800230623690

Mounting for 600 x 600
 Product SKU : 9967
 EAN Code: 3800230623676



Mounting for 1200 x 300
 Product SKU : 9969
 EAN Code: 3800230623683

Extension Frame for 625 x 625
 Product SKU : 9968
 EAN Code: 3800230623706





20W
VT-3032

6214 3000K WarmWhite
6215 4500K DayWhite
6216 6000K White

295 x 295
SIZE

1600
LUMENS

80W
EQUIVALENT

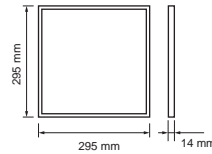

Model No.

VT-3032

Watts

20W

EQ. Watts

80W

Voltage/Frequency

AC:220-240V,50/60Hz

Luminous Flux

1600lm

LED Type

SMD

CRI

>80

PF

>0.9

Beam Angle

120°D

Body Type

Aluminum+PMMA+PS

Shape

Square

Dimension

295 x 295 x 14mm

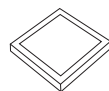

EAN Code 3000K
EAN Code 4500K
EAN Code 6000K

3800157604826
3800157604833
3800157604840



AVAILABLE WITH
SURFACE FITTING



6W VT-609

4875 3000K Warmwhite
4876 4500K Daywhite
4877 6000K White

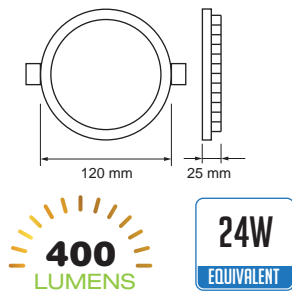

12W VT-1209

4878 3000K Warmwhite
4879 4500K Daywhite
4880 6000K White

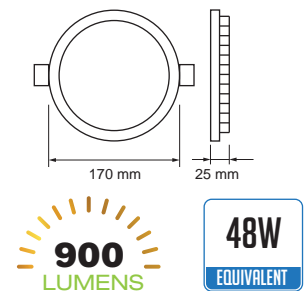

18W VT-1809



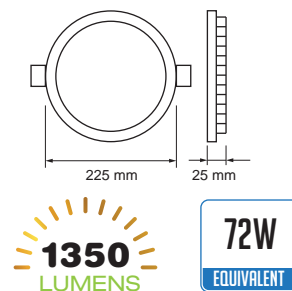

4881 3000K Warmwhite
4882 4500K Daywhite
4883 6000K White

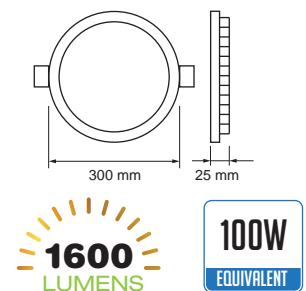

24W VT-2409

4884 3000K Warmwhite
4885 4500K Daywhite
4886 6000K White



Model No.	VT-609	VT-1209	VT-1809	VT-2409
Watts	6W	12W	18W	24W
EQ. Watts	24W	48W	72W	100W
Voltage/Frequency	DC:30-42V,50Hz	DC:30-42V,50Hz	DC:30-42V,50Hz	DC:30-42V,50Hz
Luminous Flux	400lm	900lm	1350lm	1600lm
LED Type	SMD	SMD	SMD	SMD
CRI	>80	>80	>80	>80
PF	>0.5	>0.7	>0.7	>0.7
Beam Angle	120°D	120°D	120°D	120°D
Body Type	Plastic + Aluminium Heat Sink	Plastic + Aluminium Heat Sink	Plastic + Aluminium Heat Sink	Plastic + Aluminium Heat Sink
Shape	Round	Round	Round	Round
Dimension	Ø120mm x 25mm	Ø170mm x 25mm	Ø225mm x 25mm	Ø300mm x 25mm
Cutting Size	D=Ø105mm	D=Ø155mm	D=Ø205mm	D=Ø285mm
				
EAN Code 3000K	3800157601801	3800157601832	3800157601863	3800157601894
EAN Code 4500K	3800157601818	3800157601849	3800157601870	3800157601900
EAN Code 6000K	3800157601825	3800157601856	3800157601887	3800157601917



6W
VT-607 RD

4854 / 48549 3000K Warmwhite
4855 / 48559 4500K Daywhite
4856 / 48569 6000K White

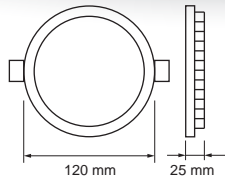

420
LUMENS

24W
EQUIVALENT

12W
VT-1207 RD

4857 / 48579 3000K Warmwhite
4858 / 48589 4500K Daywhite
4859 / 48599 6000K White

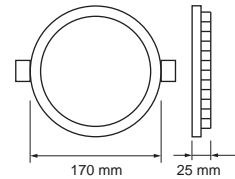

1000
LUMENS

48W
EQUIVALENT

18W
VT-1807 RD

4860 / 48609 3000K Warmwhite
4861 / 48619 4500K Daywhite
4862 / 48629 6000K White

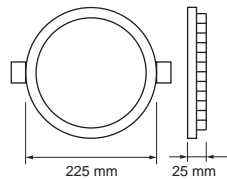

1500
LUMENS

72W
EQUIVALENT

24W
VT-2407 RD

4872 / 48729 3000K Warmwhite
4873 / 48739 4500K Daywhite
4874 / 48749 6000K White

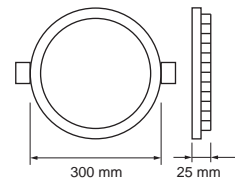

2400
LUMENS

100W
EQUIVALENT

Model No.	VT-607 RD	VT-1207 RD	VT-1807 RD	VT-2407 RD
Watts	6W	12W	18W	24W
EQ. Watts	24W	48W	72W	100W
Voltage/Frequency	AC: 200-240V, 50/60Hz	AC: 200-240V, 50/60Hz	AC: 200-240V, 50/60Hz	AC:200-240V,50Hz
Luminous Flux	420lm	1000lm	1500lm	2400lm
LED Type	SMD	SMD	SMD	SMD
CRI	>80	>80	>80	>80
PF	> 0.5	> 0.6	> 0.6	>0.9
Beam Angle	120°D	120°D	120°D	120°D
Body Type	Aluminum+PMMA+PS	Aluminum+PMMA+PS	Aluminum+PMMA+PS	Aluminum+PMMA+PS
Shape	Round	Round	Round	Round
Dimension	Ø120mm x 25mm	Ø170mm x 25mm	Ø225mm x 25mm	Ø300mm x 25mm
Cutting Size	D=Ø105mm	D=Ø155mm	D=Ø205mm	D=Ø285mm
EAN Code 3000K	3800230629753	3800230629784	3800230629814	3800157601559
EAN Code 4500K	3800230629760	3800230629791	3800230629821	3800157601566
EAN Code 6000K	3800230629777	3800230629807	3800230629838	3800157601573



6W

VT-607 SQ

4863 / 48639 3000K Warmwhite
4864 / 48649 4500K Daywhite
4865 / 48659 6000K White

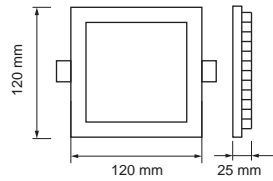

420
LUMENS

24W
EQUIVALENT

12W

VT-1207 SQ

4866 / 48669 3000K Warmwhite
4867 / 48679 4500K Daywhite
4868 / 48689 6000K White

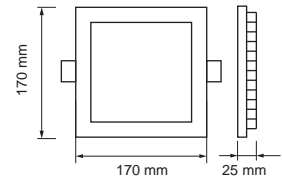

1000
LUMENS

48W
EQUIVALENT

18W

VT-1807 SQ

4869 / 48699 3000K Warmwhite
4870 / 48709 4500K Daywhite
4871 / 48719 6000K White

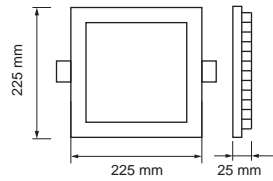

1500
LUMENS

72W
EQUIVALENT

24W

VT-2407 SQ

4887 / 48879 3000K Warmwhite
4888 / 48889 4500K Daywhite
4889 / 48899 6000K White

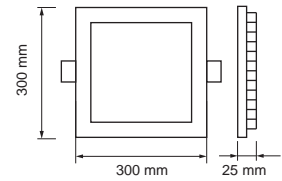

2400
LUMENS

100W
EQUIVALENT

Model No.	VT-607 SQ	VT-1207 SQ	VT-1807 SQ	VT-2407 SQ
Watts	6W	12W	18W	24W
EQ. Watts	24W	48W	72W	100W
Voltage/Frequency	AC: 200-240V, 50/60Hz	AC: 200-240V, 50/60Hz	AC: 200-240V, 50/60Hz	AC:200-240V,50Hz
Luminous Flux	420lm	1000lm	1500lm	2400lm
LED Type	SMD	SMD	SMD	SMD
CRI	>80	>80	>80	>80
PF	> 0.5	> 0.6	> 0.6	>0.9
Beam Angle	120'D	120'D	120'D	120'D
Body Type	Aluminum+PMMA+PS	Aluminum+PMMA+PS	Aluminum+PMMA+PS	Aluminum+PMMA+PS
Shape	Square	Square	Square	Square
Dimension	120 x120 x 25mm	170 x170 x 25mm	225 x 225 x 25mm	300 x300 x 25mm
Cutting Size	105mm x105mm	155mm x155mm	205mm x205mm	285mm x285mm
EAN Code 3000K	3800230629845	3800230629876	3800230629906	3800157602198
EAN Code 4500K	3800230629852	3800230629883	3800230629913	3800157602204
EAN Code 6000K	3800230629869	3800230629890	3800230629920	3800157602211

Dimmable Drivers for **PREMIUM
 PANELS**



SKU Code 8073
 Watts 6W
 Description LED DRIVER DIMMABLE
 EAN Code 3800157605823

Compatible with

48549 / 48559 / 48569 / 48639 / 48649 / 48659



SKU Code 8074
 Watts 12W
 Description LED DRIVER DIMMABLE
 EAN Code 3800157605830

Compatible with

48579 / 48589 / 48599 / 48669 / 48679 / 48689



SKU Code 8075
 Watts 18W
 Description LED DRIVER DIMMABLE
 EAN Code 3800157605847

Compatible with

48609 / 48619 / 48629 / 48699 / 48709 / 48719



SKU Code 8076
 Watts 24W
 Description LED DRIVER DIMMABLE
 EAN Code 3800157605946

Compatible with

48729 / 48739 / 48749 / 48879 / 48889 / 48899



SKU Code 8070
 Watts 18w +24W
 Description LED DRIVER DIMMABLE
 EAN Code 3800157605946

Compatible with

4860 / 4861 / 4862 / 4872 / 4873 / 4874
 4869 / 4870 / 4871 / 4887 / 4888 / 4889

LED PANELS SG SERIES



8W VT-800 RD

4823 3000K Warmwhite
4822 4500K Daywhite
4821 6000K White

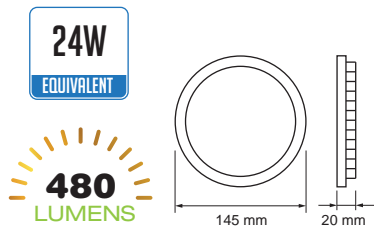

8W VT-800 SQ

4820 3000K Warmwhite
4819 4500K Daywhite
4818 6000K White

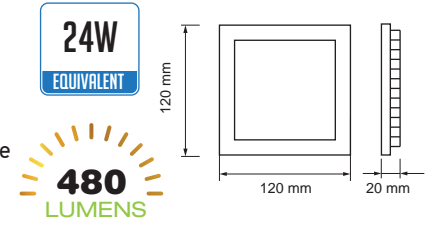

15W VT-1500 RD

4829 3000K Warmwhite
4828 4500K Daywhite
4827 6000K White

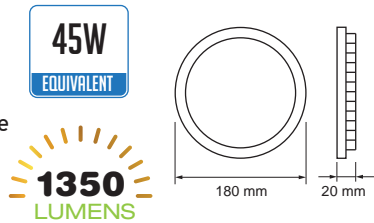

15W VT-1500 SQ

4826 3000K Warmwhite
4825 4500K Daywhite
4824 6000K White

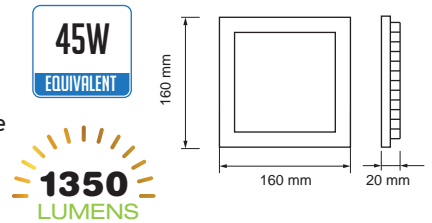

DRIVERS FOR PANELS (EMC APPROVED)

SKU	8036	8037	8058	8059
TYPE	Non-dimmable	Non-dimmable	Dimmable	Dimmable
POWER	8W	15W	8W	15W
EAN CODE	38002306255195	3800230625526	3800230625540	3800230625557

Model No.	VT-800 RD	VT-800 SQ	VT-1500 RD	VT-1500 SQ
Watts	8W	8W	15W	15W
EQ. Watts	24W	24W	45W	45W
Voltage/Frequency	AC:110-265V, 50/60Hz	AC:110-265V, 50/60Hz	AC:110-265V, 50/60Hz	AC:110-265V, 50/60Hz
Luminous Flux	480lm	480lm	1350lm	1350lm
LED Type	SMD	SMD	SMD	SMD
CRI	>80	>80	>80	>80
PF	>0.9	>0.9	>0.9	>0.9
Beam Angle	120°D	120°D	120°D	120°D
Body Type	Aluminum(PKW)	Aluminum(PKW)	Aluminum(PKW)	Aluminum(PKW)
Shape	Round	Square	Round	Square
Dimension	Ø145mm x 20mm	120 x 120 x 20mm	Ø180mm x 20mm	160 x 160 x 20mm
Cutting Size	D=Ø125mm	105 x 105mm	D=Ø160mm	140 x 140mm
EAN Code 3000K	3800230622594	3800230622570	3800230622631	3800230622617
EAN Code 4500K	3800230624963	3800230624970	3800230624987	3800230624994
EAN Code 6000K	3800230622587	3800230622563	3800230622624	3800230622600



22W
VT-2200 RD

4835 3000K Warmwhite
4834 4500K Daywhite
4833 6000K White

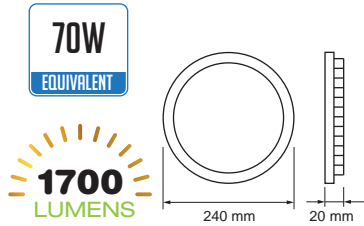

22W
VT-2200 SQ

4832 3000K Warmwhite
4831 4500K Daywhite
4830 6000K White

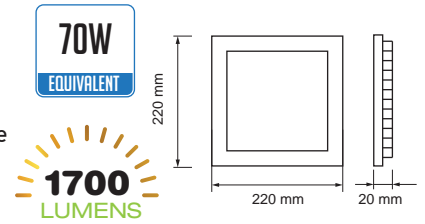

28W
VT-2800 RD

4848 3000K Warmwhite
4849 4500K Daywhite
4850 6000K White



DRIVERS FOR PANELS (EMC APPROVED)

SKU 8038
TYPE NON-DIMMABLE
POWER 22W
EAN CODE 3800230625533

8060
DIMMABLE DRIVER
22W
3800230625564

8065
NON-DIMMABLE
28W
3800230627742

Model No.	VT-2200 RD	VT-2200 SQ	VT-2800 RD
Watts	22W	22W	28W
EQ. Watts	70W	70W	84W
Voltage/Frequency	AC: 110-265V, 50/60Hz	AC: 110-265V, 50/60Hz	AC: 170-240V, 50Hz
Luminous Flux	1700lm	1700lm	1960lm
LED Type	SMD	SMD	SMD
CRI	> 80	>80	>80
PF	> 0.9	> 0.9	> 0.8
Beam Angle	120°D	120°D	120°D
Body Type	Aluminum (PKW)	Aluminum(PKW)	Aluminum(PKW)
Shape	Round	Square	Round
Dimension	Ø240mm x 20mm	220 x 220 x 20mm	Ø260mm x 20mm
Cutting Size	D=Ø220mm	195 x 195mm	D=Ø220mm
EAN Code 3000K	3800230622679	3800230622655	3800230627711
EAN Code 4500K	3800230625007	3800230625014	3800230627728
EAN Code 6000K	3800230622662	3800230622648	3800230627735

LED PANELS TRIMLESS SERIES



TRIMLESS 6.5MM

8W

VT-888 RD

4931 3000K WarmWhite
4932 4500K DayWhite
4933 6000K White

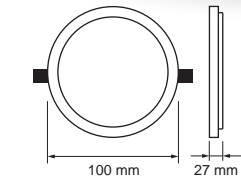

560
LUMENS

40W
EQUIVALENT

15W

VT-1515 RD

4934 3000K WarmWhite
4935 4500K DayWhite
4936 6000K White

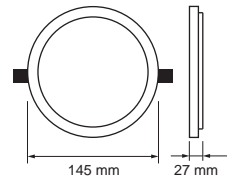

1500
LUMENS

100W
EQUIVALENT

22W

VT-2222 RD

4937 3000K WarmWhite
4938 4500K DayWhite
4939 6000K White

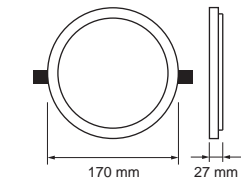

2200
LUMENS

120W
EQUIVALENT

29W

VT-2929 RD

4940 3000K WarmWhite
4941 4500K DayWhite
4942 6000K White

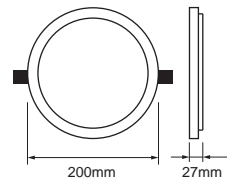

2800
LUMENS

200W
EQUIVALENT

Model No.	VT-888 RD	VT-1515 RD	VT-2222 RD	VT-2929 RD
Watts	8W	15W	22W	29W
EQ. Watts	40W	100W	120W	200W
Voltage/Frequency	AC:220-240V,50/60Hz	AC:220-240V,50/60Hz	AC:220-240V,50/60Hz	AC:220-240V,50/60Hz
Luminous Flux	560lm	1500lm	2200lm	2800lm
LED Type	SMD	SMD	SMD	SMD
CRI	>80	>80	>80	>80
PF	>0.9	>0.9	>0.9	>0.9
Beam Angle	110°D	110°D	110°D	110°D
Body Type	Die Cast Aluminum	Die Cast Aluminum	Die Cast Aluminum	Die Cast Aluminum
Shape	Round	Round	Round	Round
Dimension	Ø100mm x 27mm	Ø145mm x 27mm	Ø170mm x 27mm	Ø200mm x 27mm
Cutting Size	D=Ø90mm	D=Ø135mm	D=Ø160mm	D=Ø185mm
EAN Code 3000K	3800157606479	3800157606509	3800157606530	3800157606561
EAN Code 4500K	3800157606486	3800157606516	3800157606547	3800157606578
EAN Code 6000K	3800157606493	3800157606523	3800157606554	3800157606585



TRIMLESS 6.5MM

8W
VT-888 SQ

4943 3000K WarmWhite
 4944 4500K DayWhite
 4945 6000K White

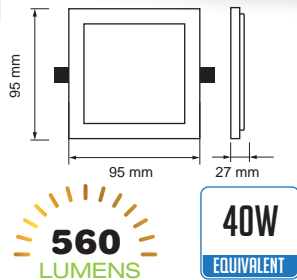

15W
VT-1515 SQ

4946 3000K WarmWhite
 4947 4500K DayWhite
 4948 6000K White

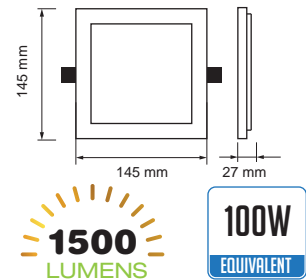

22W
VT-2222 SQ

4949 3000K WarmWhite
 4950 4500K DayWhite
 4951 6000K White

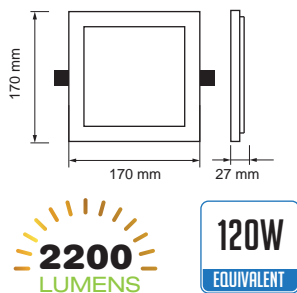

29W
VT-2929 SQ

4952 3000K WarmWhite
 4953 4500K DayWhite
 4954 6000K White

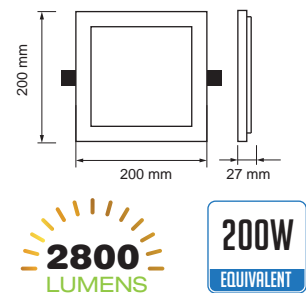

Model No.	VT-888 SQ	VT-1515 SQ	VT-2222 SQ	VT-2929 SQ
Watts	8W	15W	22W	29W
EQ. Watts	40W	100W	120W	200W
Voltage/Frequency	AC:220-240V,50/60Hz	AC:220-240V,50/60Hz	AC:220-240V,50/60Hz	AC:220-240V,50/60Hz
Luminous Flux	560lm	1500lm	2200lm	2800lm
LED Type	SMD	SMD	SMD	SMD
CRI	>80	>80	>80	>80
PF	>0.9	>0.9	>0.9	>0.9
Beam Angle	110'D	110'D	110'D	110'D
Body Type	Die Cast Aluminum	Die Cast Aluminum	Die Cast Aluminum	Die Cast Aluminum
Shape	Square	Square	Square	Square
Dimension	95 x 95x 27mm	145 x 145 x 27mm	170 x 170 x 27mm	200 x 200 x 27mm
Cutting Size	85mm x 85mm	135mm x 135mm	160mm x 160mm	185mm x 185mm
EAN Code 3000K	3800157606592	3800157606622	3800157606653	3800157606684
EAN Code 4500K	3800157606608	3800157606639	3800157606660	3800157606691
EAN Code 6000K	3800157606615	3800157606646	3800157606677	3800157606707

LED PANELS

SLIM SURFACE SERIES



6W
VT-605 RD

4904 3000K WarmWhite
4905 4500K DayWhite
4906 6000K White

420
LUMENS

35W
EQUIVALENT

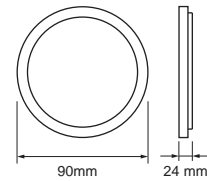

12W
VT-1205 RD

4910 3000K WarmWhite
4911 4500K DayWhite
4912 6000K White

1000
LUMENS

60W
EQUIVALENT

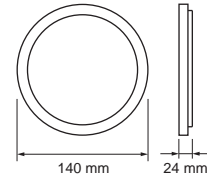

18W
VT-1805 RD

4916 3000K WarmWhite
4917 4500K DayWhite
4918 6000K White

1500
LUMENS

75W
EQUIVALENT

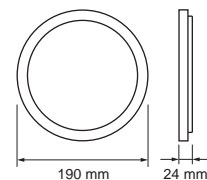

Model No.	VT-605 RD	VT-1205 RD	VT-1805 RD
Watts	6W	12W	18W
EQ. Watts	35W	60W	75W
Voltage/Frequency	AC:85-265V,50/60Hz	AC:85-265V,50/60Hz	AC:85-265V,50/60Hz
Luminous Flux	420lm	1000lm	1500lm
LED Type	SMD	SMD	SMD
CRI	>80	>80	>80
PF	>0.5	>0.6	>0.6
Beam Angle	120'D	120'D	120'D
Body Type	Aluminum	Aluminum	Aluminum
Shape	Round	Round	Round
Dimension	Ø90mm x 24mm	Ø140mm x 24mm	Ø190mm x 24mm



EAN Code 3000K
EAN Code 4500K
EAN Code 6000K

3800157605380
3800157605397
3800157605403

3800157605441
3800157605458
3800157605465

3800157605502
3800157605519
3800157605526



6W
VT-605 SQ

4904 3000K WarmWhite
4905 4500K DayWhite
4906 6000K White

420
LUMENS

35W
EQUIVALENT

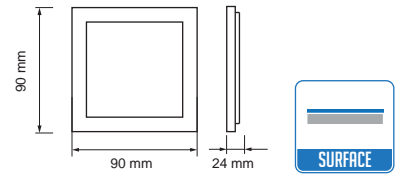

12W
VT-1205 SQ

4910 3000K WarmWhite
4911 4500K DayWhite
4912 6000K White

1000
LUMENS

60W
EQUIVALENT

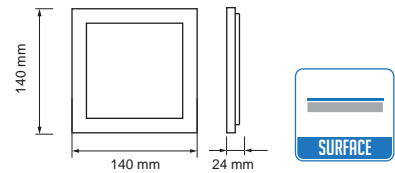

18W
VT-1805 SQ

4916 3000K WarmWhite
4917 4500K DayWhite
4918 6000K White

1500
LUMENS

75W
EQUIVALENT

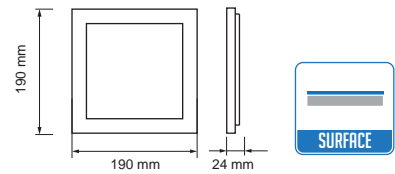

Model No.	VT-605 SQ	VT-1205 SQ	VT-1805 SQ
Watts	6W	12W	18W
EQ. Watts	35W	60W	75W
Voltage/Frequency	AC:85-265V,50/60Hz	AC:85-265V,50/60Hz	AC:85-265V,50/60Hz
Luminous Flux	420lm	1000lm	1500lm
LED Type	SMD	SMD	SMD
CRI	>80	>80	>80
PF	>0.5	>0.6	>0.6
Beam Angle	120°D	120°D	120°D
Body Type	Aluminum	Aluminum	Aluminum
Shape	Square	Square	Square
Dimension	90 x 90 x 24mm	140 x 140 x 24mm	190 x 190 x 24mm



EAN Code 3000K
EAN Code 4500K
EAN Code 6000K

3800157605410
3800157605427
3800157605434

3800157605472
3800157605489
3800157605496

3800157605533
3800157605540
3800157605557



8W
VT-1408 RD

4805 3000K Warmwhite
4804 4500K Daywhite
4803 6000K White

480
LUMENS

24W
EQUIVALENT

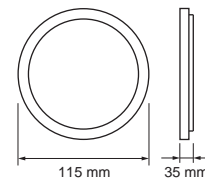

15W
VT-1415 RD

4811 3000K Warmwhite
4810 4500K Daywhite
4809 6000K White

1350
LUMENS

45W
EQUIVALENT

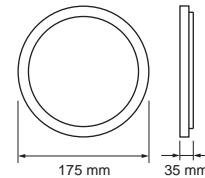





22W
VT-1422 RD

4817 3000K Warmwhite
4816 4500K Daywhite
4815 6000K White

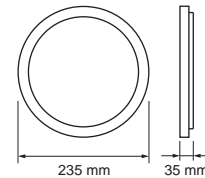
1700
LUMENS

66W
EQUIVALENT



Model No.	VT-1408 RD	VT-1415 RD	VT-1422 RD
Watts	8W	15W	22W
EQ. Watts	24W	45W	66W
Voltage/Frequency	AC: 110-265V, 50/60Hz	AC: 110-265V, 50/60Hz	AC: 110-265V, 50/60Hz
Luminous Flux	480lm	1350lm	1700lm
LED Type	SMD	SMD	SMD 5630
CRI	>80	>80	> 80
PF	> 0.9	> 0.9	> 0.9
Beam Angle	120°D	120°D	120°D
Body Type	Aluminum(PKW)	Aluminum(PKW)	Aluminum (PKW)
Shape	Round	Round	Round
Dimension	Ø115mm x 35mm	Ø175mm x 35mm	Ø235mm x 35mm
Cutting Size	D=Ø 70mm 	D=Ø 130mm 	D=Ø 190mm 
EAN Code 3000K	3800230622730	3800230622792	3800230622853
EAN Code 4500K	3800230622723	3800230622785	3800230622846
EAN Code 6000K	3800230622716	3800230622778	3800230622839



8W
VT-1408 SQ

4802 3000K Warmwhite
4801 4500K Daywhite
4800 6000K White

480
LUMENS

24W
EQUIVALENT

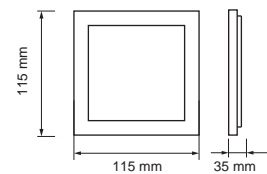

15W
VT-1415 SQ

4808 3000K Warmwhite
4807 4500K Daywhite
4806 6000K White

1350
LUMENS

45W
EQUIVALENT

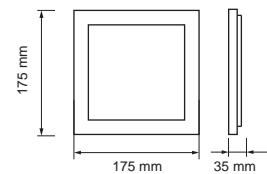

22W
VT-1422 SQ

4814 3000K Warmwhite
4813 4500K Daywhite
4812 6000K White

1700
LUMENS

66W
EQUIVALENT

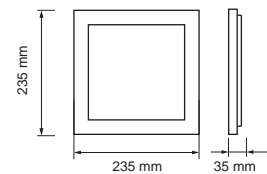

Model No.	VT-1408 SQ	VT-1415 SQ	VT-1422 SQ
Watts	8W	15W	22W
EQ. Watts	24W	45W	66W
Voltage/Frequency	AC: 110-265V, 50/60Hz	AC: 110-265V, 50/60Hz	AC: 110-265V, 50/60Hz
Luminous Flux	480lm	1350lm	1700lm
LED Type	SMD 5630	SMD 5630	SMD 5630
CRI	>80	>80	> 80
PF	> 0.9	> 0.9	> 0.9
Beam Angle	120°D	120°D	120°D
Body Type	Aluminum(PKW)	Aluminum(PKW)	Aluminum (PKW)
Shape	Square	Square	Square
Dimension	115 x 115 x 35mm	175 x 175 x 35mm	235mm x 235mm x 35mm
Cutting Size			



EAN Code 3000K
EAN Code 4500K
EAN Code 6000K

3800230622709
3800230622693
3800230622686

3800230622761
3800230622754
3800230622747

3800230622822
3800230622815
3800230622808



TWINLED
SERIES



8W
VT-809

4890 3000K Warmwhite
4891 4500K Daywhite
4892 6000K White

560
LUMENS

24W
EQUIVALENT

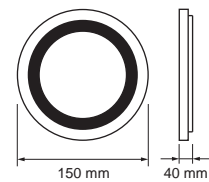

15W
VT-1509

4893 3000K Warmwhite
4894 4500K Daywhite
4895 6000K White

1200
LUMENS

45W
EQUIVALENT

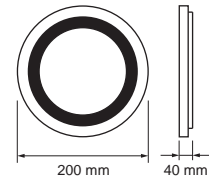

22W
VT-2209

4896 3000K Warmwhite
4897 4500K Daywhite
4898 6000K White

1800
LUMENS

66W
EQUIVALENT

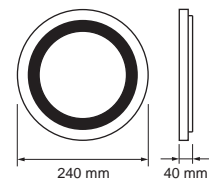

Model No.	VT-809	VT-1509	VT-2209
Watts	8W	15W	22W
EQ. Watts	24W	45W	66W
Voltage/Frequency	AC:100-240V,50/60Hz	AC:100-240V,50/60Hz	AC:100-240V,50/60Hz
Luminous Flux	560lm	1200lm	1800lm
LED Type	SMD	SMD	SMD
CRI	>80	>80	>80
PF	>0.9	>0.9	>0.9
Beam Angle	120°D	120°D	120°D
Body Type	PKW	PKW	PKW
Shape	Round	Round	Round
Dimension	Ø150mm x 40mm	Ø200mm x 40mm	Ø240mm x 40mm



EAN Code 3000K
EAN Code 4500K
EAN Code 6000K

3800157602594
3800157602600
3800157602617

3800157602624
3800157602631
3800157602648

3800157602655
3800157602662
3800157602679



TWINLED
SERIES

SURFACE
MOUNTED

8W
VT-809 SQ

4922 3000K WarmWhite
4923 4500K DayWhite
4924 6000K White

560
LUMENS

24W
EQUIVALENT

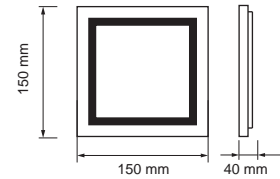

15W
VT-1509 SQ

4925 3000K WarmWhite
4926 4500K DayWhite
4927 6000K White

1200
LUMENS

45W
EQUIVALENT

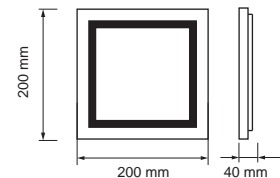

22W
VT-2209 SQ

4928 3000K WarmWhite
4929 4500K DayWhite
4930 6000K White

1800
LUMENS

66W
EQUIVALENT

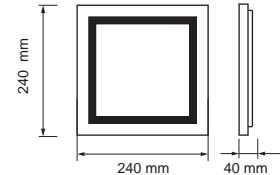

Model No.	VT-809 SQ	VT-1509 SQ	VT-2209 SQ
Watts	8W	15W	22W
EQ. Watts	24W	45W	66W
Voltage/Frequency	AC:100-240V,50/60Hz	AC:100-240V,50/60Hz	AC:100-240V,50/60Hz
Luminous Flux	560lm	1200lm	1800lm
LED Type	SMD	SMD	SMD
CRI	>80	>80	>80
PF	>0.9	>0.9	>0.9
Beam Angle	120'D	120'D	120'D
Body Type	PKW	PKW	PKW
Shape	Square	Square	Square
Dimension	150 x 150 x 40mm	200 x 200 x 40mm	240 x 240 x 40mm



EAN Code 3000K
EAN Code 4500K
EAN Code 6000K

3800157605564
3800157605571
3800157605588

3800157605595
3800157605601
3800157605618

3800157605625
3800157605632
3800157605649

LED PANELS GLASS SERIES



6W
VT-602G RD

4740 3000K Warmwhite
N/A 4500K Daywhite
4739 6000K White

420
LUMENS

20W
EQUIVALENT

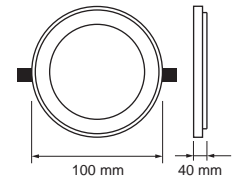

12W
VT-1202G RD

4744 3000K Warmwhite
N/A 4500K Daywhite
4743 6000K White

840
LUMENS

40W
EQUIVALENT

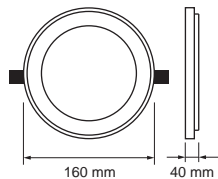

18W
VT-1881G RD

4760 3000K Warmwhite
N/A 4500K Daywhite
4759 6000K White

1260
LUMENS

60W
EQUIVALENT

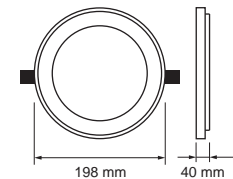

Model No.	VT-602G RD	VT-1202G RD	VT-1881G RD
Watts	6W	12W	18W
EQ. Watts	20W	40W	60W
Voltage/Frequency	AC: 100-240V, 50/60Hz	AC: 100-240V, 50/60Hz	AC: 100-240V, 50/60Hz
Luminous Flux	420lm	840lm	1260lm
LED Type	SMD	SMD	SMD
CRI	>80	>80	>80
PF	>0.5	> 0.5	> 0.5
Beam Angle	120'D	120'D	120'D
Body Type	Glass+Aluminum	Glass+Aluminum	Glass+Aluminum
Shape	Round	Round	Round
Dimension	Ø100mm x40mm	Ø160mm x40mm	Ø198mm x40mm
Cutting Size	D=Ø75mm	D=Ø120mm	D=Ø145mm
EAN Code 3000K	3800230622891	3800230622938	3800230622976
EAN Code 4500K	N/A	N/A	N/A
EAN Code 6000K	3800230622884	3800230622921	3800230622969



6W 4738 3000K Warmwhite
N/A 4500K Daywhite
VT-602G SQ 4737 6000K White

420
LUMENS

20W
EQUIVALENT

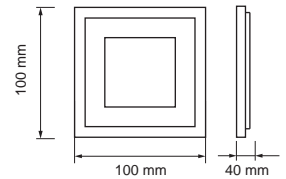

12W
VT-1202G SQ

4742 3000K Warmwhite
N/A 4500K Daywhite
4741 6000K White

840
LUMENS

40W
EQUIVALENT

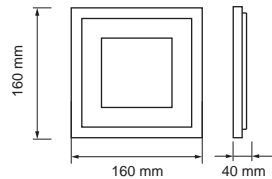

18W
VT-1881G SQ

4746 3000K Warmwhite
N/A 4500K Daywhite
4745 6000K White

1260
LUMENS

60W
EQUIVALENT

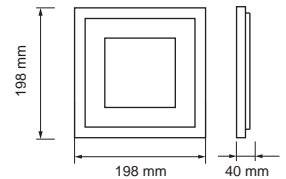

Model No.	VT-602G SQ	VT-1202G SQ	VT-1881G SQ
Watts	6W	12W	18W
EQ. Watts	20W	40W	60W
Voltage/Frequency	AC: 100-240V, 50/60Hz	AC: 100-240V, 50/60Hz	AC: 100-240V, 50/60Hz
Luminous Flux	420lm	840lm	1260lm
LED Type	SMD	SMD	SMD
CRI	>80	>80	>80
PF	>0.5	> 0.5	> 0.5
Beam Angle	120'D	120'D	120'D
Body Type	Glass+Aluminum	Glass+Aluminum	Glass+Aluminum
Shape	Round	Round	Round
Dimension	100 x 100 x 40mm	160 x 160 x 40mm	198x 198 x 40mm
Cutting Size	75mm x 75mm	120mm x 120mm	145mm x 145mm
EAN Code 3000K	3800230622877	3800230622914	3800230622952
EAN Code 4500K	N/A	N/A	N/A
EAN Code 6000K	3800230622860	3800230622907	3800230622945



LED FLOOD LIGHTS

V-TAC's LED Floodlights are ideal for lighting Driveways, Gardens and Buildings. These energy efficient lights emit Bright, Vibrant Light and are an eco friendly replacement for traditional Halogen Floodlights and Metal Halide fixtures

PRODUCT FEATURES

- Available in White , Warm White and RGB Light output option
- Available from 10W up to 400W
- Premium Quality Aluminium Alloy body
- Corrosion Resistant
- Fascia glass sealed with SILICONE RUBBER ensuring superior waterproof / airtight performance
- High Power LED chip
- Built in constant current driver
- Better Power Savings
- Built in Power supply, No external ballast required

APPLICATIONS

- Widely used for Lighting Driveways, Gardens & Buildings, Commercial Bill Boards & Hoardings, Plazas, Sports Grounds & Parking Lots





10W N/A 3000K Warmwhite
VT-4810 5733 4500K Daywhite
5734 6000K White

**SUPER
SLIM**

**HIGH POWER
SMD**

Model No	VT-4810
Watts	10W
EQ. Watts	50W
Voltage/Frequency	AC:100-240V,50/60Hz
Luminous Flux	800lm
CRI	>70
PF	>0.95
Beam Angle	100°D
Color of Fixture	White
Body Type	Die cast Aluminum
IP Rating	IP65
Dimension	132 x 117 x 36mm



EAN Code 3000K
EAN Code 4500K
EAN Code 6000K

N/A
3800157606905
3800157606912

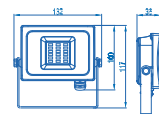
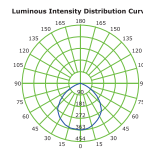
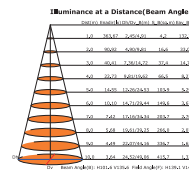



10W
VT-4810

5720 3000K Warmwhite
5721 4500K Daywhite
5722 6000K White

**SUPER
SLIM**

**HIGH POWER
SMD**

Model No	VT-4810
Watts	10W
EQ. Watts	50W
Voltage/Frequency	AC:100-240V,50/60Hz
Luminous Flux	800lm
CRI	>70
PF	>0.95
Beam Angle	100°D
Color of Fixture	Grey & Black
Body Type	Die cast Aluminum
IP Rating	IP65
Dimension	132 x 117 x 36mm

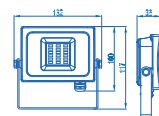
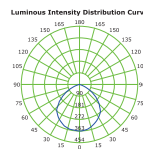
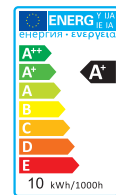
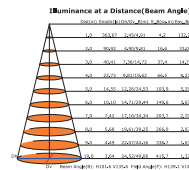

EAN Code 3000K
EAN Code 4500K
EAN Code 6000K

3800157605120
3800157605137
3800157605144

SLIM LED FLOODLIGHT

like never seen before!



20W VT-4820

5676 3000K Warmwhite
5677 4500K Daywhite
5678 6000K White

30W VT-4830

5679 3000K Warmwhite
5680 4500K Daywhite
5681 6000K White

50W VT-4850

5682 3000K Warmwhite
5683 4500K Daywhite
5684 6000K White

100W VT-48100

5685 3000K Warmwhite
5686 4500K Daywhite
5687 6000K White

Model No	VT-4820	VT-4830	VT-4850	VT-48100
Watts	20W	30W	50W	100W
EQ. Watts	100W	150W	250W	500W
Voltage/Frequency	AC:100-240V,50/60Hz	AC:100-240V,50/60Hz	AC:100-240V,50/60Hz	AC:100-240V,50/60Hz
Luminous Flux	1600lm	2400lm	4000lm	8000lm
CRI	>70	>70	>70	>70
PF	>0.95	>0.95	>0.95	>0.95
Beam Angle	100'D	100'D	100'D	100'D
Color of Fixture	White	White	White	White
Body Type	Die cast Aluminum	Die cast Aluminum	Die cast Aluminum	Die cast Aluminum
IP Rating	IP65	IP65	IP65	IP65
Dimension	182 x 142 x 36mm	233 x 188 x 36mm	296 x 225 x 40mm	353 x 268 x 46mm



EAN Code 3000K
EAN Code 4500K
EAN Code 6000K

3800157603355
3800157603362
3800157603379



3800157603386
3800157603393
3800157603409



3800157603416
3800157603423
3800157603430



3800157603447
3800157603454
3800157603461

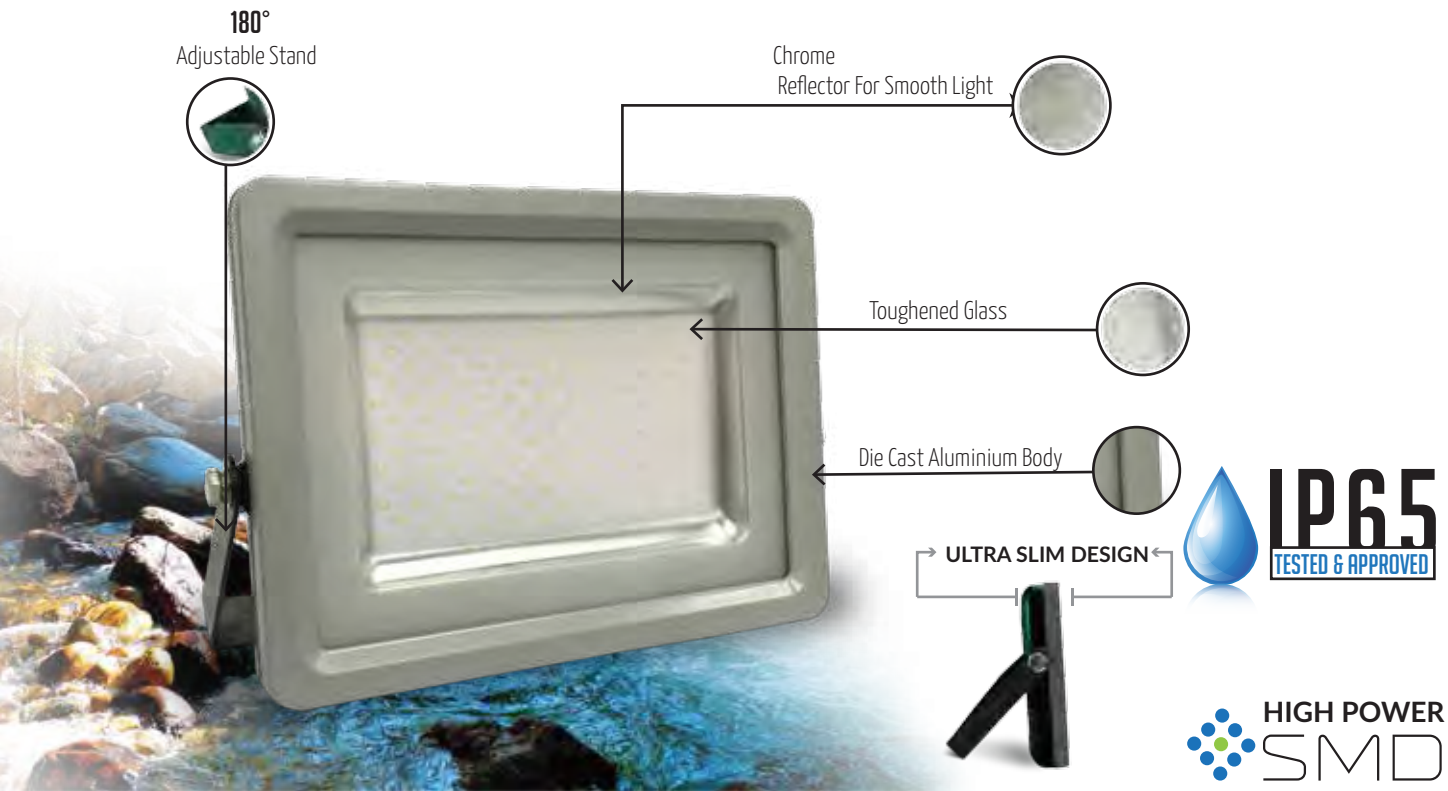

20W VT-4820

5703 3000K Warmwhite
5704 4500K Daywhite
5705 6000K White

30W VT-4830

5706 3000K Warmwhite
5707 4500K Daywhite
5708 6000K White

50W VT-4850

5709 3000K Warmwhite
5710 4500K Daywhite
5711 6000K White

100W VT-48100

5712 3000K Warmwhite
5713 4500K Daywhite
5714 6000K White

Model No	VT-4820	VT-4830	VT-4850	VT-48100
Watts	20W	30W	50W	100W
EQ. Watts	100W	150W	250W	500W
Voltage/Frequency	AC:100-240V,50/60Hz	AC:100-240V,50/60Hz	AC:100-240V,50/60Hz	AC:100-240V,50/60Hz
Luminous Flux	1600lm	2400lm	4000lm	8000lm
CRI	>70	>70	>70	>70
PF	>0.95	>0.95	>0.95	>0.95
Beam Angle	100°D	100°D	100°D	100°D
Color of Fixture	Grey & Black	Grey & Black	Grey & Black	Grey & Black
Body Type	Die cast Aluminum	Die cast Aluminum	Die cast Aluminum	Die cast Aluminum
IP Rating	IP65	IP65	IP65	IP65
Dimension	182 x 142 x 36mm	233 x 188 x 36mm	296 x 225 x 40mm	353 x 268 x 46mm



EAN Code 3000K
EAN Code 4500K
EAN Code 6000K

3800157604444
3800157604451
3800157604468

3800157604475
3800157604482
3800157604499

3800157604505
3800157604512
3800157604529

3800157604536
3800157604543
3800157604550



20W
VT-4820

5718 Green



Model No	VT-4820
Watts	20W
EQ. Watts	100W
Voltage/Frequency	AC:100-240V,50/60Hz
Luminous Flux	1600lm
CRI	>70
PF	>0.95
Beam Angle	100'D
Color of Fixture	Grey & Black
Body Type	Die cast Aluminum
IP Rating	IP65
Dimension	182 x 142 x 36mm



EAN Code Green

3800157604970

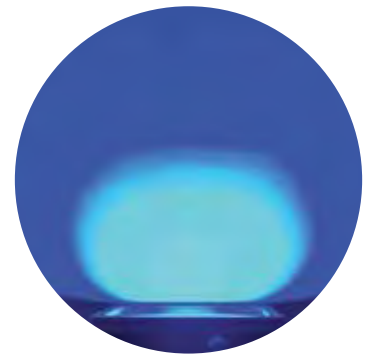

20W
VT-4820

5719 Blue



Model No	VT-4820
Watts	20W
EQ. Watts	100W
Voltage/Frequency	AC:100-240V,50/60Hz
Luminous Flux	1600lm
CRI	>70
PF	>0.95
Beam Angle	100'D
Color of Fixture	Grey & Black
Body Type	Die cast Aluminum
IP Rating	IP65
Dimension	182 x 142 x 36mm



EAN Code Blue

3800157604987

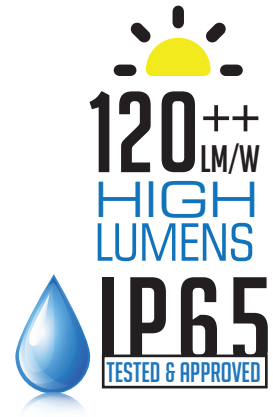

100W N/A 3000K Warmwhite
VT-48104 5741 4500K Daywhite
 5742 6000K White



Model No	VT-48104
Watts	100W
EQ. Watts	600W
Voltage/Frequency	AC:100-240V,50/60Hz
Luminous Flux	12000lm
CRI	>70
PF	>0.95
Beam Angle	100°D
Color of Fixture	White
Body Type	Die cast Aluminum
IP Rating	IP65
Dimension	353 x 268 x 46mm



EAN Code 3000K
 EAN Code 4500K
 EAN Code 6000K

N/A
[3800157607742](#)
[3800157607759](#)



100W N/A 3000K Warmwhite
VT-48104 5743 4500K Daywhite
5744 6000K White



Model No	VT-48104
Watts	100W
EQ. Watts	600W
Voltage/Frequency	AC:100-240V,50/60Hz
Luminous Flux	12000lm
CRI	>70
PF	>0.95
Beam Angle	100°D
Color of Fixture	Grey & Black
Body Type	Die cast Aluminum
IP Rating	IP65
Dimension	353 x 268 x 46mm



EAN Code 3000K
EAN Code 4500K
EAN Code 6000K

N/A
3800157607766
3800157607773





150W
VT-48152

N/A 3000K Warmwhite
5739 500K Daywhite
5740 6000K White



150W
VT-48150

5688 3000K Warmwhite
5689 4500K Daywhite
5690 6000K White



Model No

VT-48152

VT-48150

Watts	150W	150W
EQ. Watts	750W	750W
Voltage/Frequency	AC:100-240V,50/60Hz	AC:100-240V,50/60Hz
Luminous Flux	12000lm	12000lm
CRI	>70	>70
PF	>0.95	>0.95
Beam Angle	120'D	120'D
Color of Fixture	Grey & Black	Grey & Black
Body Type	Die cast Aluminum	Die cast Aluminum
IP Rating	IP65	IP65
Dimension	423 x 352x 60mm	260 x 385 x 113mm



EAN Code 3000K
EAN Code 4500K
EAN Code 6000K

N/A
3800157607711
3800157607728

3800157603478
3800157603485
3800157603492



200W
VT-48202

N/A 3000K Warmwhite
5729 4500K Daywhite
5730 6000K White



300W
VT-48302

N/A 3000K Warmwhite
5731 4500K Daywhite
5732 6000K White



Model No	VT-48202	VT-48302
Watts	200W	300W
EQ. Watts	1000W	1500W
Voltage/Frequency	AC:100-240V,50/60Hz	AC:100-240V,50/60Hz
Luminous Flux	16000lm	24000lm
CRI	>70	>70
PF	>0.9	>0.9
Beam Angle	100°D	100°D
Color of Fixture	Grey & Black	Grey & Black
Body Type	Die cast Aluminum	Die cast Aluminum
IP Rating	IP65	IP65
Dimension	423 x 352 x 60 mm	532 x 443 x 70 mm



EAN Code 3000K
EAN Code 4500K
EAN Code 6000K

N/A
3800157606127
3800157606134

N/A
3800157606141
3800157606158



10W
VT-4810 PIR

5746 3000K Warmwhite
5747 4500K Daywhite
5748 6000K White



PIR
SENSOR
SERIES



10W
VT-4810 PIR

5723 3000K Warmwhite
5724 4500K Daywhite
5725 6000K White



Model No

Watts
EQ. Watts
Voltage/Frequency
Luminous Flux
CRI
PF
Beam Angle
Color of Fixture
Body Type
IP Rating
Dimension

VT-4810 PIR

10W
50W
AC:100-240V,50/60Hz
800lm
>70
>0.95
100°D
White
Die cast Aluminum
IP44
133x178x47mm

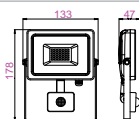

VT-4810 PIR

10W
50W
AC:100-240V,50/60Hz
800lm
>70
>0.95
100°D
Black
Die cast Aluminum
IP44
133x178x47mm

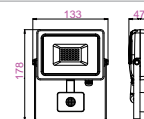

EAN Code 3000K
EAN Code 4500K
EAN Code 6000K

3800157608206
3800157608213
3800157608220

3800157605724
3800157605731
3800157605748

PIR
SENSOR
SERIES



20W
VT-4820 PIR

5697 3000K Warmwhite
5698 4500K Daywhite
5715 6000K White



RECHARGEABLE



20W
VT-4822

N/A 3000K Warmwhite
5692 4500K Daywhite
5735 6000K White



Model No	VT-4820 PIR	VT-4822
Watts	20W	20W
EQ. Watts	100W	80W
Voltage/Frequency	AC:100-240V,50/60Hz	AC:85-265V,50/60Hz
Luminous Flux	1600lm	1600lm
CRI	>70	/
PF	>0.95	>0.95
Beam Angle	100'D	120'D
Color of Fixture	Black	Green
Body Type	Die cast Aluminum	Die cast Aluminum
IP Rating	IP44	IP54
Dimension	185x211x50mm	208 x 204 x 355mm

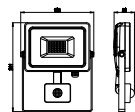

EAN Code 3000K 3800157604338
EAN Code 4500K 3800157604345
EAN Code 6000K 3800157604949

N/A
3800157603515
3800157606929



30W
VT-4830 PIR

5699 3000K Warmwhite
5700 4500K Daywhite
5716 6000K White



50W
VT-4850 PIR

5701 3000K Warmwhite
5702 4500K Daywhite
5717 6000K White



Model No	VT-4830 PIR	VT-4850 PIR
Watts	30W	50W
EQ. Watts	150W	250W
Voltage/Frequency	AC:100-240V,50/60Hz	AC:100-240V,50/60Hz
Luminous Flux	2400lm	4000lm
CRI	>70	>70
PF	>0.95	>0.95
Beam Angle	100°D	100°D
Color of Fixture	Black	Black
Body Type	Die cast Aluminum	Die cast Aluminum
IP Rating	IP44	IP44
Dimension	237x255x51mm	237x255x51mm

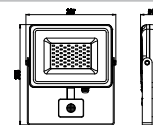
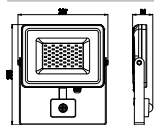

EAN Code 3000K
EAN Code 4500K
EAN Code 6000K

3800157604352
3800157604369
3800157604956

3800157604376
3800157604383
3800157604963



10W
VT-4710 5370



10W
VT-4710 5369



30W
VT-4730 5371



50W
VT-4752 5691



Model No	VT-4710 RGB	VT-4710 RGB	VT-4730 RGB	VT-4752 RGB
Watts	10W	10W	30W	50W
EQ. Watts	40W	40W	120W	250W
Voltage/Frequency	AC: 90-240V, 50/60Hz	AC: 90-240V, 50/60Hz	AC: 90-240V, 50/60Hz	AC:100-240V,50/60Hz
Luminous Flux	600lm	600lm	1800lm	4000lm
CRI	> 80	> 80	> 80	/
PF	> 0.8	> 0.8	> 0.8	>0.95
Beam Angle	120°D	120°D	120°D	120°D
Color of Fixture	Grey	Grey	Grey	Grey
Body Type	Aluminum	Aluminum	Aluminum	Die cast Aluminum
IP Rating	IP65	IP65	IP65	IP65
Dimension	115 x 87 x 85mm	115 x 87 x 85mm	228 x 205 x 135mm	227 x 130 x 205mm



EAN Code RGB

3800230624567

3800230624550

3800230624574

3800157603508



200W N/A 3000K Warmwhite
VT-47200 5644 4500K Daywhite
5385 6000K White



Model No	VT-47200
Watts	200W
EQ. Watts	800W
Voltage/Frequency	AC:90-240V,50/60Hz
Luminous Flux	16000lm
CRI	> 70
PF	> 0.9
Beam Angle	120°D
Color of Fixture	Grey
Body Type	Die cast Aluminum
IP Rating	IP65
Dimension	380 x 340 x 120mm



EAN Code 3000K
EAN Code 4500K
EAN Code 6000K

N/A
3800157600767
3800230627421

Illuminance at a Distance (Beam Angle)

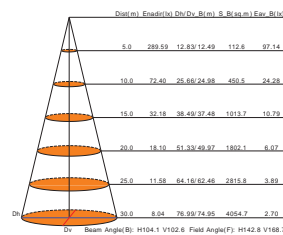

Luminous Intensity Distribution Curve

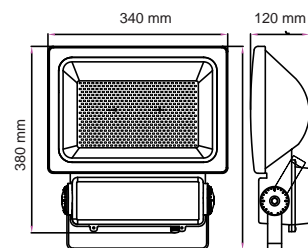
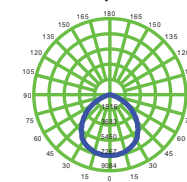



300W
VT-47300

N/A 3000K Warmwhite
5693 4500K Daywhite
5386 6000K White

HIGH POWER
SMD

Model No	VT-47300
Watts	300W
EQ. Watts	1200W
Voltage/Frequency	AC:90-240V,50/60Hz
Luminous Flux	24000lm
CRI	> 70
PF	> 0.9
Beam Angle	120°D
Color of Fixture	Grey
Body Type	Die cast Aluminum
IP Rating	IP65
Dimension	430 x 410 x 145mm



EAN Code 3000K
EAN Code 4500K
EAN Code 6000K

N/A
3800157603652
3800230627438

Illuninance at a Distance(Beam Angle)

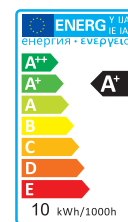
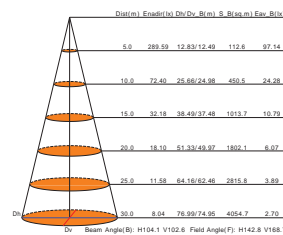

Luminous Intensity Distribution Curve

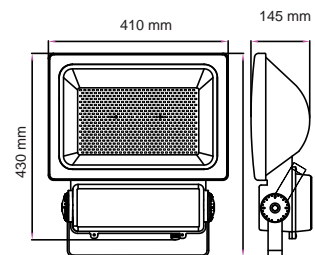
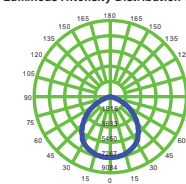



400W

VT-47400

N/A 3000K Warmwhite
5694 4500K Daywhite
5649 6000K White

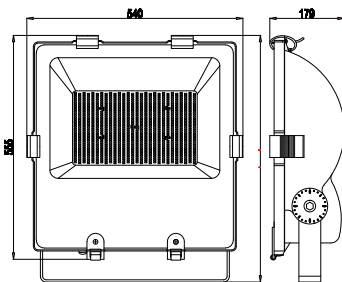

500W

VT-47500

N/A 3000K Warmwhite
5695 4500K Daywhite
5696 6000K White



Model No	VT-47400	VT-47500
Watts	400W	500W
EQ. Watts	1600W	2000W
Voltage/Frequency	AC:90-240V,50/60Hz	AC:100-240V,50/60Hz
Luminous Flux	32000lm	40000lm
CRI	> 70	>70
PF	> 0.9	>0.95
Beam Angle	120'D	120'D
Color of Fixture	Black	Black
Body Type	Die cast Aluminum	Die cast Aluminum
IP Rating	IP65	IP65
Dimension	555 x 540 x 179mm	555 x 540 x 179mm



EAN Code 3000K
EAN Code 4500K
EAN Code 6000K

N/A
3800157603669
3800157601269

N/A
3800157603805
3800157603812



600W VT-47600

N/A 3000K Warmwhite
5726 4500K Daywhite
N/A 6000K White



Model No	VT-47600
Watts	600W
EQ. Watts	3000W
Voltage/Frequency	AC:100-240V,50/60Hz
Luminous Flux	48000lm
CRI	>80
PF	>0.9
Beam Angle	120'D
Color of Fixture	Black
Body Type	Die cast Aluminum
IP Rating	IP65
Dimension	540x555x625mm



EAN Code 3000K
EAN Code 4500K
EAN Code 6000K

N/A
3800157605854
N/A

Illuninance at a Distance(Beam Angle)

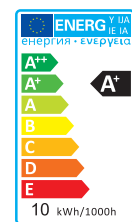
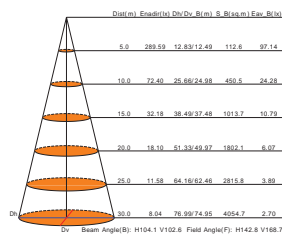

Luminous Intensity Distribution Curve

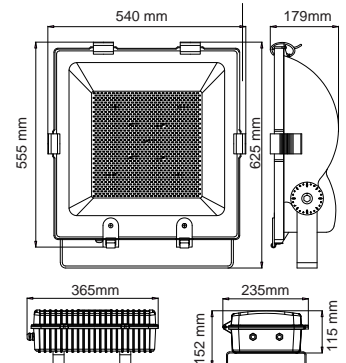
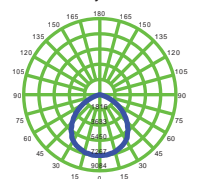



18W

VT-4818

N/A 3000K Warmwhite
 N/A 4500K Daywhite
 5745 6000K White



Model No	VT-4818
Power	AC100-240V
Output	18W
Detection Range	0-12M
Detect Angle	180°
Delay Time	0-30S
LED	42PCS 0.2W
Lumen	600LM
Material	ABS +Aluminum
Image sensor	1/4 " 1Megapixel CMOS
Video Compression	H.264 /MJPEG dual video stream
Max Image Resolution	1280*720
Pixel	1 million pixels
Size	270x 170 x 170mm



EAN Code 3000K	N/A
EAN Code 4500K	N/A
EAN Code 6000K	3800157608268

TRIPOD STAND FOR FLOOD LIGHTS (YELLOW)



Model No	VT-778
SKU Code	9104
EAN Code	3800230626202



TRIPOD STAND FOR FLOOD LIGHTS (BLACK)

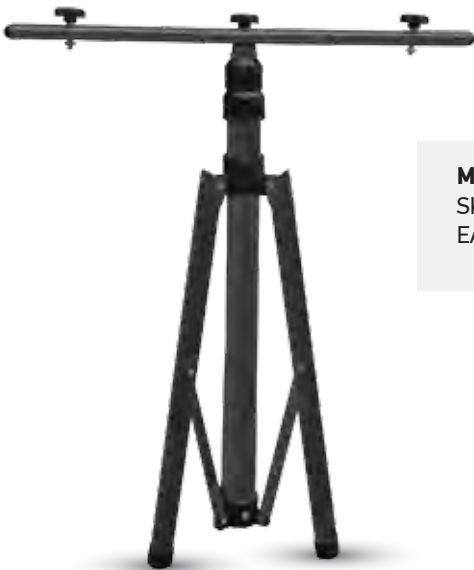

Model No	VT-778
SKU Code	9546
EAN Code	3800157604925



Accessories **LED Floodlights**

WATERPROOF BOX TERMINAL BLOCK

Model No VT-729
SKU Code 3621
EAN Code 3800157607735

Can work for
wire 3x0.75mm².
wire 3x1 .0rnm²
Inside Terminal block



Model No VT-7224
SKU Code 3578
EAN Code 3800157605335

Can work for
wire 3x0.75mm².
wire 3x1 .0rnm²
wire 3x1 .5mm²



BILLBOARD STAND FOR FLOOD LIGHTS

Model No VT-794
SKU Code 3623
EAN Code 3800157607810

85CM

SUITABLE FOR:
10W - 20W - 30W - 50W



Model No VT-793
SKU Code 3622
EAN Code 3800157607803

87CM

SUITABLE FOR:
70W - 100W - 120W - 150W - 200W





LED HIGHBAYS

Designed to provide drastic reductions in both energy consumption and maintenance requirements, V-TAC's LED High Bay Series provide uniform light with no dark patches and good colour rendering. Available models 50W - 200W

PRODUCT FEATURES

- Powerful LED light source with a unique design
- Extensive Options can replace all types of Standard MH High bays
- Aluminium Diffuser with multiple Beam Angle's to choose from 45°D / 90°D / 120°D
- Shatter Proof Perspex Lens
- High Thermal Conductivity, Low Luminous Decay, Pure Colours & No Heavy Shade
- The unique design of Radiator fuses with the Lamp Box perfectly hence diffuses the heat conduction efficiently which reduces the temperature of inside lamp & ensures the LED long life span
- Non - Flickering
- No UV Radiation

APPLICATIONS

- Perfect fit for Industrial Usage, Warehouse & Super Markets, Workshop's, Factories, Warehouse's, Highway, toll Stations, Gas Stations, Malls, Exhibition Halls, Stadium's & other vast areas





4000
LUMENS

50W
VT-9051

N/A 3000K Warmwhite
5516 4500K Daywhite
5517 6000K White

HIGH POWER
SMD

200W
EQUIVALENT



8000
LUMENS

100W
VT-9101

N/A 3000K Warmwhite
5519 4500K Daywhite
5518 6000K White

HIGH POWER
SMD

400W
EQUIVALENT



12000
LUMENS

150W
VT-9152

N/A 3000K Warmwhite
N/A 4500K Daywhite
5520 6000K White

HIGH POWER
SMD

600W
EQUIVALENT



16000
LUMENS

200W
VT-9202

N/A 3000K Warmwhite
5526 4500K Daywhite
5525 6000K White

HIGH POWER
SMD

1000W
EQUIVALENT

Model No.	VT-9051	VT-9101	VT-9152	VT-9202
Watts	50W	100W	150W	200W
EQ. Watts	200W	400W	600W	1000W
Voltage/Frequency	AC: 100-265V, 50/60Hz	AC: 100-265V, 50/60Hz	AC: 100-265V, 50/60Hz	AC:100-265V, 50/60Hz
Luminous Flux	4000lm	8000lm	12000lm	16000lm
LED Type	SMD	SMD	SMD	SMD
CRI	> 70	> 70	> 70	>70
PF	> 0.9	> 0.9	> 0.9	>0.95
Beam Angle	45'D/120'D	90'D/120'D	90'D/120'D	90/120'D
Body Type	Aluminum	Aluminum	Aluminum	Aluminum
IP Rating	IP44	IP44	IP44	IP44
Dimension	Φ348 x 145 x 346mm	Φ535 x 107 x 306mm	Φ535 x 107 x 306mm	Φ428 x 145mm



EAN Code 3000K
EAN Code 4500K
EAN Code 6000K

N/A
3800230629425
3800230629432

N/A
3800157600927
3800157600910

N/A
N/A
3800157600989

N/A
3800157601931
3800157601924

HIGH POWER
SMD





120⁺⁺ LM/W
HIGH LUMENS

12000
LUMENS

100W
VT-9104

N/A 3000K Warmwhite
N/A 4500K Daywhite
5532 6000K White

600W
EQUIVALENT

90°
BEAM ANGLE

120°
BEAM ANGLE

Model No.	VT-9104
Watts	100W
EQ. Watts	600W
Voltage/Frequency	AC: 100-265V, 50/60Hz
Luminous Flux	12000lm
LED Type	SMD
CRI	> 70
PF	> 0.9
Beam Angle	90'D/120'D
Body Type	Aluminum
IP Rating	IP44
Dimension	D:535 x 107 x 306mm

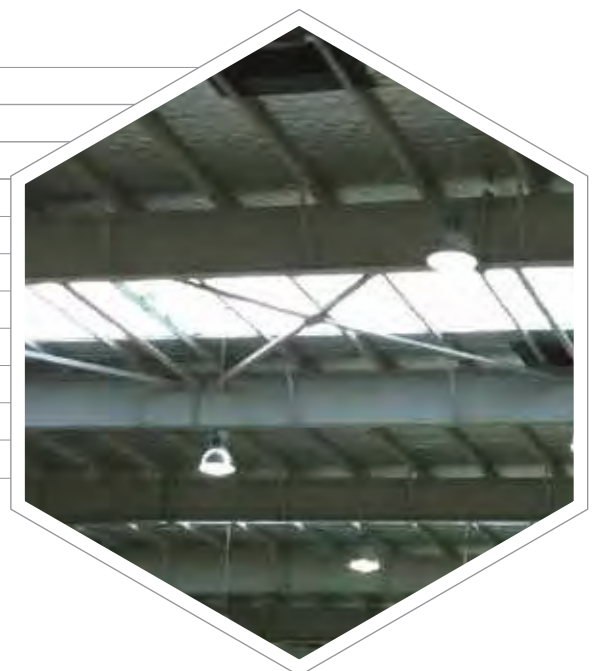

EAN Code 6000K

3800157607780





LED STREET LIGHTS

Light the path to the future with LED Street Lights. This state of the art LED Technology provides uniform Brightness and Illumination. No mercury means they are environmentally friendly

PRODUCT FEATURES

- Perfect replacement for traditional lights
- Saves 80% Electricity cost, Better Efficiency, Longer Life Span
- Dedicated IP65 Sealed Optical Cavities
- Optically Optimized Glass Lenses
- Uniformity in Light Distribution – Maximizes Efficiency
- Fully Operational in Extreme Weather up to -20° Celsius
- Low maintenance & Low Power consumption
- Reduced CO² emissions

APPLICATIONS

- Out Door Applications like Streets, Projects, Cross Roads, Tunnels, Car Parks, Industrial Facilities etc



HIGH POWER
SMD

2700
LUMENS

30W
VT-15130ST

5464 3000K Warmwhite
5456 4500K Daywhite
5457 6000K White

100°
BEAM ANGLE

150W
EQUIVALENT



4500
LUMENS

50W
VT-15150ST

5465 3000K Warmwhite
5458 4500K Daywhite
5459 6000K White

100°
BEAM ANGLE

250W
EQUIVALENT

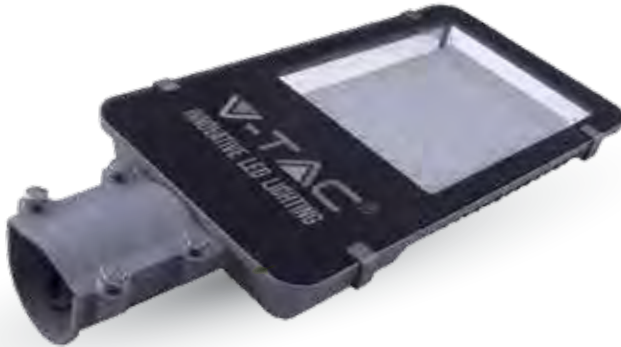

6400
LUMENS

80W
VT-15080ST

N/A 3000K Warmwhite
5466 4500K Daywhite
5467 6000K White

100°
BEAM ANGLE

400W
EQUIVALENT



Model No.	VT-15130ST	VT-15150ST	VT-15080ST
Watts	30W	50W	80W
EQ. Watts	150W	250W	400W
Voltage/Frequency	AC:85-265V,50/60Hz	AC:85-265V,50/60Hz	AC:100-240V,50/60Hz
Luminous Flux	2700lm	4500lm	6400lm
LED Type	SMD	SMD	SMD
CRI	>75	>75	>75
PF	>0.95	>0.95	>0.95
Beam Angle	100'D	100'D	100'D
Color of Fixture	Black	Black	Black
Body Type	Die Cast Aluminum	Die Cast Aluminum	Die Cast Aluminum
IP Rating	IP65	IP65	IP65
Dimension	216 x 497 x 75mm	216 x 497 x 75mm	263 x 615 x 75mm
Pole Size	Ø60mm	Ø60mm	Ø60mm
EAN Code 3000K	3800157604802	3800157604819	N/A
EAN Code 4500K	3800157603539	3800157603553	3800157606936
EAN Code 6000K	3800157603546	3800157603560	3800157606943

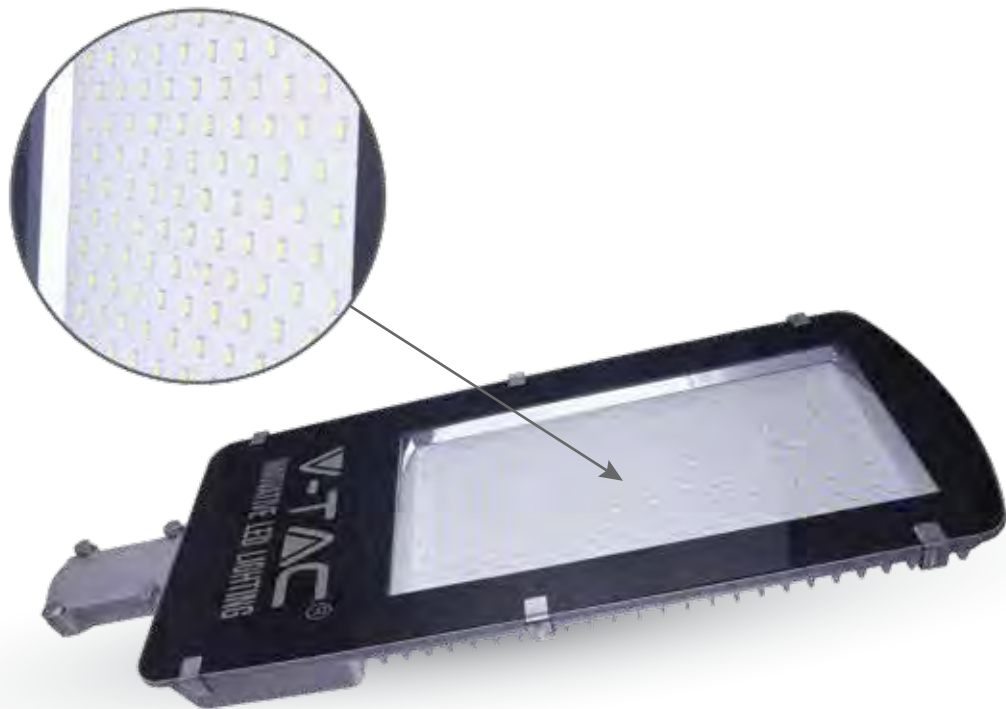

9000
LUMENS

100W
VT-15100ST

N/A 3000K Warmwhite
5462 4500K Daywhite
5463 6000K White



10800
LUMENS

120W
VT-15120ST

N/A 3000K Warmwhite
5460 4500K Daywhite
5461 6000K White







12000
LUMENS

150W
VT-15155ST

N/A 3000K Warmwhite
5455 4500K Daywhite
5453 6000K White



Model No.	VT-15100ST	VT-15120 ST	VT-15155 ST
Watts	100W	120W	150W
EQ. Watts	500W	600W	750W
Voltage/Frequency	AC:85-265V,50/60Hz	AC:85-265V,50/60Hz	AC:100-265V,50/60Hz
Luminous Flux	9000lm	10800lm	12000lm
LED Type	SMD	SMD	SMD
CRI	>75	>75	>70
PF	>0.95	>0.95	0.95
Beam Angle	100°D	100°D	100°D
Color of Fixture	Black	Black	Black
Body Type	Die Cast Aluminum	Die Cast Aluminum	Die Cast Aluminum
IP Rating	IP65	IP65	IP65
Dimension	296 x 703 x 70mm	297 x 703 x 70mm	302 x 802 x 75mm
PoleSize	Ø60mm 	Ø60mm 	Ø60mm 
EAN Code 3000K	N/A	N/A	N/A
EAN Code 4500K	3800157603591	3800157603577	3800157603522
EAN Code 6000K	3800157603607	3800157603584	3800157602884

120⁺⁺ LM/W
HIGH LUMENS

100W
VT-15104 ST

N/A 3000K Warmwhite
 N/A 4500K Daywhite
 5468 6000K White



Model No.

VT-15104 ST

Watts	100W
EQ. Watts	600W
Voltage/Frequency	AC:85-265V,50/60Hz
Luminous Flux	12000lm
LED Type	SMD
CRI	>75
PF	>0.95
Beam Angle	100°D
Color of Fixture	Black
Body Type	Die Cast Aluminum
IP Rating	IP65
Dimension	297 x 703 x 70mm
PoleSize	Ø60mm



EAN Code 3000K
 EAN Code 4500K
 EAN Code 6000K

N/A
 N/A
 3800157607797



LED STREETLIGHT ACCESSORIES

STREETLIGHT-ADAPTER

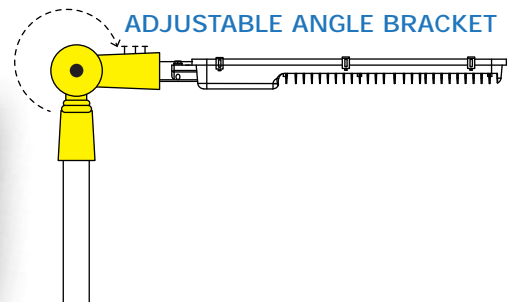

Model No.	VT-795
SKU Code	3624
Color	Black
Body	Aluminum
EAN Code	3800157608152

COMPATIBLE WITH ALL OUR STREET LIGHT MODELS, THIS ADAPTER ALLOWS THE ANGLE OF THE STREETLIGHT TO BE ADJUSTED AS PER CLIENT'S REQUIREMENTS



LED STRIP LIGHTS

Add an extensive array of lights and colors to any setting or interior, rejuvenate and transform the ambience of any environment at the flick of a switch with V-TAC's LED Strip Light Series. Easy installation with minimal space requirement makes this the right choice for Restaurants, Auditoriums and Meeting Rooms etc.

PRODUCT FEATURES

- LED strip is a low Voltage flexible Ribbon available in 12v
- Flexible & easy installation
- Exceptionally low power consumption
- Multiple visual effects in unending colours and shades
- Available in 12V and 220V with different color range from Warm White to RGB
- Available in IP20 and IP65 rating
- Available in 8mm or 10mm width
- Available in 1 or 1.5 meter rigid bar options with different options of Aluminium Profiles

APPLICATIONS

- Ideal for illuminating Borders, Edges, Cabinets, Bars and any area with limited space for installation
- Safe to use in most of the application



5050-WP 30 LED/M



LED Type	5050	Color	SKU Code	EAN Code
Watt/M	4.8W	White	2144	3800230621399
Current/M	.4A	Warm White	2145	3800230621412
Voltage	12V	Daywhite	N/A	N/A
LED Qty	30	Red	2129	3800230621450
LM/LED	14	Green	N/A	N/A
Beam Angle	120°	Blue	2142	3800230621436
IP Rating	IP65	Yellow	N/A	N/A
Width	10mm	RGB	2118	3800230621528

5050-NON WP 30 LED/M



LED Type	5050	Color	SKU Code	EAN Code
Watt/M	4.8W	White	2133	3800230621382
Current/M	.4A	Warm White	2135	3800230621405
Voltage	12V	Daywhite	N/A	N/A
LED Qty	30	Red	2136	3800230621443
LM/LED	12	Green	N/A	N/A
Beam Angle	120°	Blue	2127	3800230621429
IP Rating	IP20	Yellow	N/A	N/A
Width	10mm	RGB	2124	3800230621535

5050-NON WP 60 LED/M



LED Type	5050	Color	SKU Code	EAN Code
Watt/M	9.6W	White	2126	3800230621481
Current/M	.8A	Warm White	2122	3800230621504
Voltage	12V	Daywhite	2143	3800230621467
LED Qty	60	Red	2128	3800230624468
LM/LED	14	Green	2138	3800230621443
Beam Angle	120°	Blue	2137	3800230621429
IP Rating	IP20	Yellow	2156	3800230628824
Width	10mm	RGB	2120	3800230621542

5050-WP 60 LED/M



LED Type	5050	Color	SKU Code	EAN Code
Watt/M	9.6W	White	2148	3800230621498
Current/M	.8A	Warm White	2149	3800230621511
Voltage	12V	Daywhite	2150	3800230621474
LED Qty	60	Red	2152	3800230624775
LM/LED	14	Green	2153	3800230621450
Beam Angle	120°	Blue	2151	3800230621436
IP Rating	IP65	Yellow	N/A	N/A
Width	10mm	RGB	2155	3800230621559

LED STRIP LIGHTS

3528 SERIES

3528-NON WP 60 LED/M



LED Type	3528	Color	SKU Code	EAN Code
Watt/M	3.6W	White	2005	3800230621153
Current/M	.3A	Warm White	2016	3800230621160
Voltage	12V	Daywhite	2041	3800230621184
LED Qty	60	Red	2015	3800230621269
LM/LED	5	Green	2011	3800230621221
Beam Angle	120°	Blue	2013	3800230621252
IP Rating	IP20	Yellow	2009	3800230621214
Width	8mm	RGB	N/A	N/A

3528-WP 60 LED/M



LED Type	3528	Color	SKU Code	EAN Code
Watt/M	3.6W	White	2031	3800230621146
Current/M	.3A	Warm White	2032	3800230621177
Voltage	12V	Daywhite	2043	3800230621191
LED Qty	60	Red	2036	3800230621276
LM/LED	5	Green	2034	3800230621238
Beam Angle	120°	Blue	2035	3800230621245
IP Rating	IP65	Yellow	2033	3800230621207
Width	8mm	RGB	N/A	N/A

3528-NON WP 120 LED/M



LED Type	3528	Color	SKU Code	EAN Code
Watt/M	7.2W	White	2002	3800230621283
Current/M	.6A	Warm White	2025	3800230621306
Voltage	12V	Daywhite	2042	3800230621320
LED Qty	120	Red	2030	3800230621368
LM/LED	5	Green	N/A	N/A
Beam Angle	120°	Blue	2029	3800230621344
IP Rating	IP20	Yellow	N/A	N/A
Width	8mm	RGB	N/A	N/A

3528-WP 120 LED/M



LED Type	3528	Color	SKU Code	EAN Code
Watt/M	7.2W	White	2037	3800230621290
Current/M	.6A	Warm White	2038	3800230621313
Voltage	12V	Daywhite	2044	3800230621337
LED Qty	120	Red	2039	3800230621375
LM/LED	5	Green	N/A	N/A
Beam Angle	120°	Blue	2027	3800230621351
IP Rating	IP65	Yellow	N/A	N/A
Width	8mm	RGB	N/A	N/A

3014-NON WP 204 LED/M



204
LED/M



IP20



LED Type	3014	Color	SKU Code	EAN Code
Watt/M	18W	White	2403	3800230628053
Current/M	1.5A	Warm White	2404	3800230628060
Voltage	12V	Daywhite	2405	3800157600309
LED Qty	204	Red	N/A	N/A
LM/LED	10LM	Green	N/A	N/A
Beam Angle	120°	Blue	N/A	N/A
IP Rating	IP20	Yellow	N/A	N/A
Width	10mm	RGB	N/A	N/A

**5050-NON WP 60 LED/M
 RGB+W**



60
LED/M



IP20



LED Type	5050	Color	SKU Code	EAN Code
Watt/M	14.4W	White	N/A	N/A
Current/M	1.2A	Warm White	N/A	N/A
Voltage	12V	Daywhite	N/A	N/A
LED Qty	30:30	Red	N/A	N/A
LM/LED	15LM	Green	N/A	N/A
Beam Angle	120°	Blue	N/A	N/A
IP Rating	IP20	Yellow	N/A	N/A
Width	10mm	RGB	2159(RGB+W)	3800230629623



Rigid-Bar 5630-NON WP 72LED/M

72
LED/M



LED Type	5630	Color	SKU Code	EAN Code
Watt/M	16W	White	2308	3800230621702
Current/M	1.3A	Warm White	2309	3800230621719
Voltage	12V	Daywhite	2314	3800230628497
LED Qty	72	Red	N/A	N/A
LM/LED	20:22	Green	N/A	N/A
Beam Angle	120°	Blue	N/A	N/A
IP Rating	IP20	Yellow	N/A	N/A
Width	10mm	RGB	N/A0	N/A

Rigid-Bar With Profile 5630-NON WP 72LED/M

72
LED/M

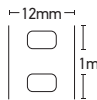

LED Type	5630	Color	SKU Code	EAN Code
Watt/M	18W	White	2310	3800230627810
Current/M	1.5A	Warm White	2311	3800230627827
Voltage	12V	Daywhite	N/A	N/A
LED Qty	72	Red	N/A	N/A
LM/LED	22	Green	N/A	N/A
Beam Angle	120°	Blue	N/A	N/A
IP Rating	IP20	Yellow	N/A	N/A
Width	12mmx1meter	RGB	N/A	N/A

Rigid-Bar With Profile 5630-NON WP 72LED/M

72
LED/M

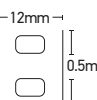

LED Type	5630	Color	SKU Code	EAN Code
Watt/M	18W	White	2312	3800230627830
Current/M	1.5A	Warm White	2313	3800230627841
Voltage	12V	Daywhite	N/A	N/A
LED Qty	72	Red	N/A	N/A
LM/LED	22	Green	N/A	N/A
Beam Angle	120°	Blue	N/A	N/A
IP Rating	IP20	Yellow	N/A	N/A
Width	12mmx0.5meter	RGB	N/A	N/A



INTRODUCING

LED NEON FLEX

LED NEON STRIP LIGHT



MODEL	VT-555	VT-555	VT-555
SKU CODE	2512	2513	2514
Color/ Temperature	White	Warmwhite	Daywhite
Lumen LM/M	320±5%	320±5%	320±5%
FPC Width MM	7.5	7.5	7.5
Power W/M	8-10W	8-10W	8-10W
Jacket Dia	9 x16.5 mm	9 x16.5 mm	9 x16.5 mm
EAN CODE	3800157605656	3800157605663	3800157605670



MODEL	VT-555
SKU CODE	2515
Color/ Temperature	Blue
Lumen LM/M	320±5%
FPC Width MM	7.5
Power W/M	8-10
Jacket Dia	9 x16.5 mm
EAN CODE	3800157605687

MODEL	VT-555
SKU CODE	2516
Color/ Temperature	RED
Lumen LM/M	320±5%
FPC Width MM	7.5
Power W/M	8-10
Jacket Dia	9 x16.5 mm
EAN CODE	3800157605694

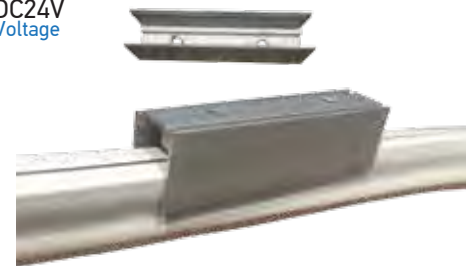

Item	Profile
SKU CODE	2527

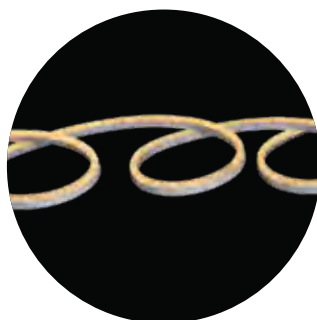
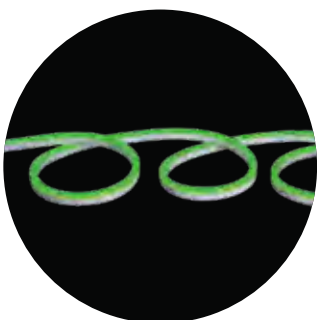

MODEL	VT-555
SKU CODE	2517
Color/ Temperature	Green
Lumen LM/M	320±5%
FPC Width MM	7.5
Power W/M	8-10
Jacket Dia	9 x16.5 mm
EAN CODE	3800157605700

MODEL	VT-555
SKU CODE	2518
Color/ Temperature	Yellow
Lumen LM/M	320±5%
FPC Width MM	7.5
Power W/M	8-10
Jacket Dia	9 x16.5 mm
EAN CODE	3800157605717



Item	Power cord without plug
SKU CODE	3331
EAN CODE	3800157608268



Item	Pin
SKU CODE	3333
EAN CODE	3800157607889



Item	End safe cap
SKU CODE	3334
EAN CODE	3800157607896

LED STRIP SETS PLUG AND PLAY



LED STRIP LIGHT set is a complete kit where we provide you with 5 meters of LED STRIP LIGHT ,along with the POWER SUPPLY and CONNECTOR and REMOTE CONTROL (optional) ,to make it a complete kit . Available and made in different colour options as per requirement.

- LED Strip
- Remote control (included)
- Driver (included)
- Packing: Blister Pack, 5 meters roll

SKU CODE	DESCRIPTION	EAN CODE
2351	LED Strip Set SMD3528 60 LEDs 4500K IP20	3800230621634
2350	LED Strip Set SMD5050 30 LEDs RGB IP20	3800230621641
2352	LED Strip Set SMD5050 30 LEDs RGB IP65	3800230621658
2353	LED Strip Set SMD5050 60 LEDs RGB IP20	3800230621665
2354	LED Strip Set SMD5050 60 LEDs RGB IP65	3800230621672
2355	LED Strip Set SMD5050 60 LEDs White IP20	3800230621689
2356	LED Strip Set SMD5050 60 LEDs White IP65	3800230621696

LED STRIP ACCESSORIES

SKU CODE	DESCRIPTION	EAN CODE
3500	Flexible Connector - LED Strip 3528	3800230622051
3501	Flexible Connector - LED Strip 5050	3800230622068
3502	Flexible Connector - LED Strip 5050 RGB	3800230622075
3503	Connector - LED Strip 3528	3800230622082
3504	Connector - LED Strip 5050	3800230622099
3505	Connector - LED Strip 5050 RGB	3800230622105
3507	Flexible Connector - LED Strip 3528 DC Female	N/A
3508	Flexible Connector - LED Strip 5050 DC Female	N/A
3509	Connector - LED Strip 3528 Cross Type	N/A
3510	Connector - LED Strip 5050 Cross Type	N/A
3511	Connector - LED Strip 5050 L Type	N/A
3512	Connector - LED Strip DC Female	3800230622112



**ALUMINIUM PROFILES
FOR LED STRIPS**

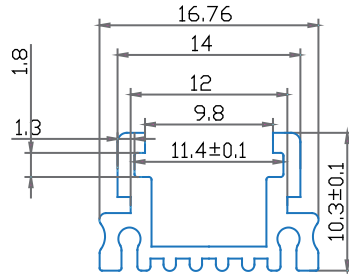
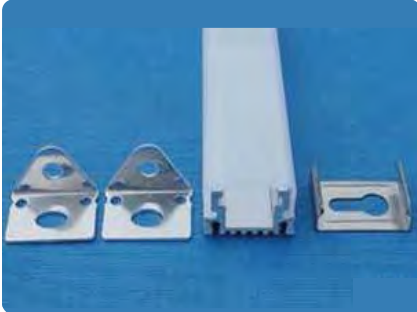

MODEL NO:	VT-7101
SKU CODE:	9981
SIZE:	16.76 x 10.3 x 1000 mm
COLOR:	Transparent
EAN CODE:	3800230622129

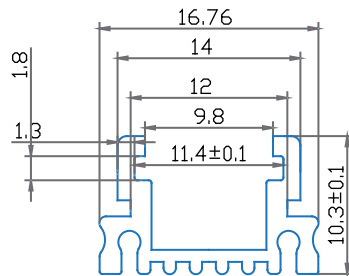
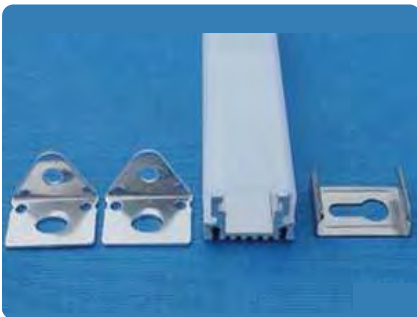

MODEL NO:	VT-7101
SKU CODE:	9982
SIZE:	16.76 x 10.3 x 1000 mm
COLOR:	Matt
EAN CODE:	3800230622136

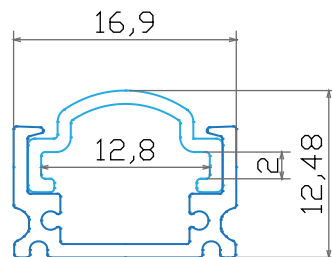

MODEL NO:	VT-7102
SKU CODE:	9983
SIZE:	16.9 x 12.48 x 1000 mm
COLOR:	Transparent
EAN CODE:	3800230622143

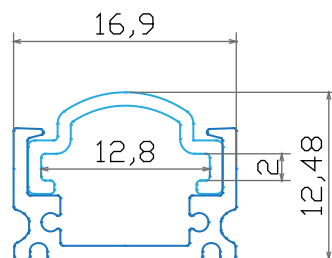

MODEL NO:	VT-7102
SKU CODE:	9984
SIZE:	16.9 x 12.48 x 1000 mm
COLOR:	Matt
EAN CODE:	3800230622150

ALUMINIUM PROFILES
FOR LED STRIPS

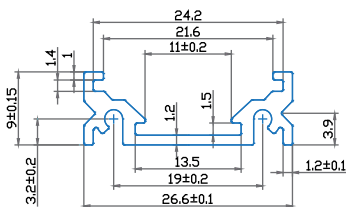

MODEL NO:	VT-7103
SKU CODE:	9985
SIZE:	26.5 x 9 x 1000 mm
COLOR:	Transparent
EAN CODE:	3800230622167

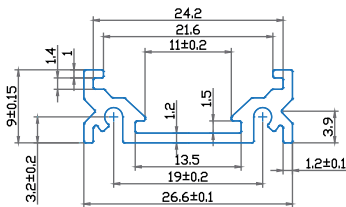

MODEL NO:	VT-7103
SKU CODE:	9986
SIZE:	26.5 x 9 x 1000 mm
COLOR:	Matt
EAN CODE:	3800230622174

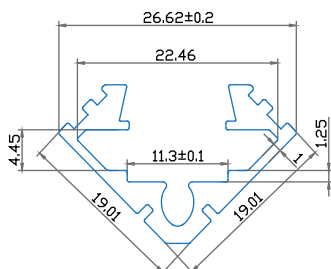
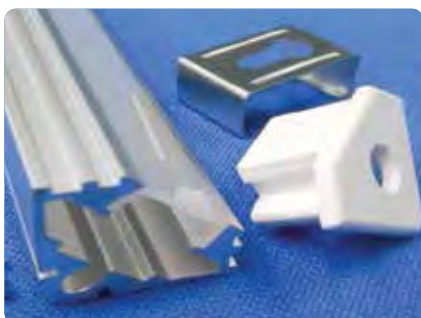

MODEL NO:	VT-7104
SKU CODE:	9987
SIZE:	19 x 19 x 1000 mm
COLOR:	Matt
EAN CODE:	3800230622181

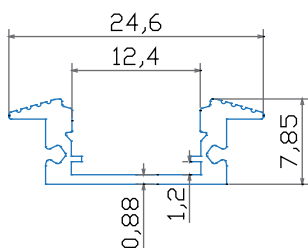

MODEL NO:	VT-7105
SKU CODE:	9990
SIZE:	24.6 x 7.85 x 1000 mm
COLOR:	Milky
EAN CODE:	3800230628077

**ALUMINIUM PROFILES
FOR LED STRIPS**

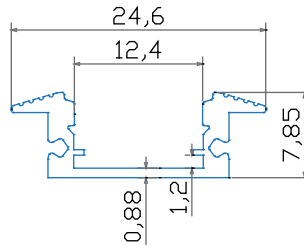
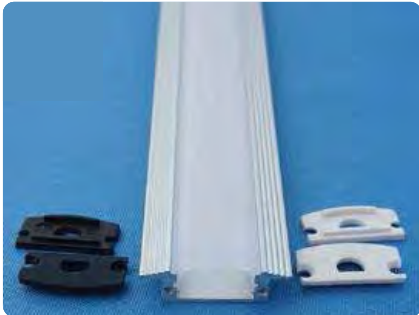

MODEL NO:	VT-7105
SKU CODE:	9991
SIZE:	24.6 x 7.85 x 2000 mm
COLOR:	Milky
EAN CODE:	3800230628794

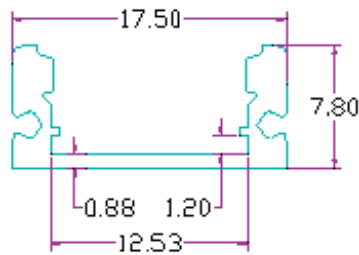
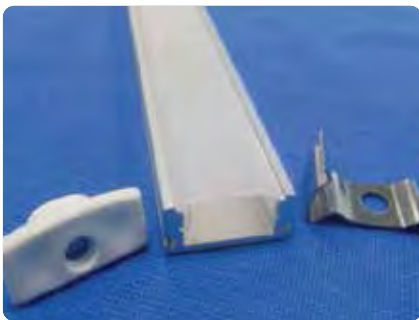

MODEL NO:	VT-7106
SKU CODE:	9992 /9993
SIZE:	17.5 x 7.8 x1000 / 2000 mm
COLOR:	Milky / Milky
EAN CODE:	3800230628800 3800230628817

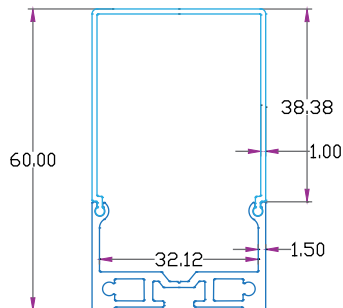

MODEL NO:	VT-7107
SKU CODE:	9994
SIZE:	60 x 35.1 x 1000 mm
COLOR:	Milky
EAN CODE:	3800157601399

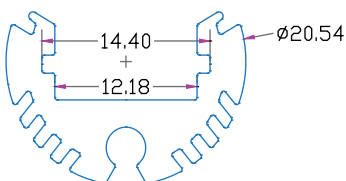

MODEL NO:	VT-7108
SKU CODE:	9995
SIZE:	ø20.54 x 1000 mm
COLOR:	Milky
EAN CODE:	3800157601405

LED STRIP CONTROLLERS



DC12/24V
Voltage

SKU Code	3300
Model No.	VT-2402
Description	Dimmer for LED Strip with Remote Control
Max Current /Watt	8A, 96W
Input Voltage	DC 12/24 V
Size	115 x 55 x 35 mm
EAN Code	3800230622198



DC12/24V
Voltage

SKU Code	3303
Model No.	VT-2404
Description	Radio Controller with Remote Control 4 Buttons
Max Current /Watt	12A, 144W
Input Voltage	DC 12/24 V
Size	105 x 65 x 20 mm
EAN Code	3800230622204



INFRARED
REMOTE
CONTROL DC12/24V
Voltage

SKU Code	3304
Model No.	VT-2401
Description	Infrared Controller with Remote Control 24 Buttons
Max Current /Watt	6A, 72W
Input Voltage	DC 12/24 V
Size	65 x 35 x 22 mm
EAN Code	3800230622211



DC12V
Voltage

SKU Code	3307
Model No.	VT- DMX 512
Description	DMX 512 Controller
Max Current /Watt	4A x3, 144W
Input Voltage	DC 12V
Size	165 x 75 x 25 mm
EAN Code	3800230622266



DC12/24V
Voltage

SKU Code	3312
Model No.	VT-2405
Description	Radio Controller with Touch Remote Control
Max Current /Watt	3A x4, 144W
Input Voltage	DC 12/24 V
Size	130 x 65 x 25 mm
EAN Code	3800230622273



DC12/24V
Voltage

SKU Code	3317
Model No.	VT-2401
Description	Infrared Controller with Remote Control 44 Buttons
Max Current /Watt	6A, 72W
Input Voltage	DC 12/24 V
Size	125 x 56 x 7 mm
EAN Code	3800230622228



DC12V
Voltage

SKU Code	3318
Model No.	N/A
Description	Radio Controller with Remote Control
Max Current /Watt	500W
Input Voltage	DC 12V
Size	120 x 75 x 25 mm
EAN Code	3800230622235



RF
REMOTE
CONTROL

DC12V
Voltage

SKU Code	3320
Model No.	N/A
Description	Mini RF Controller
Max Current /Watt	N/A
Input Voltage	DC 12V
Size	N/A
EAN Code	3800230628022

LED STRIP CONTROLLERS



DC12V Voltage

SKU Code	3319
Model No.	N/A
Description	24B Mini Controller
Max Current /Watt	N/A
Input Voltage	DC 12V
Size	N/A
EAN Code	3800230628015



DC12V Voltage

SKU Code	3321
Model No.	N/A
Description	Wi-Fi Single Controller
Max Current /Watt	N/A
Input Voltage	DC 12V
Size	N/A
EAN Code	3800230628039



DC12V Voltage

SKU Code	3322
Model No.	N/A
Description	Wi-Fi RGB Controller
Max Current /Watt	N/A
Input Voltage	DC 12V
Size	N/A
EAN Code	3800230628046



DC12V Voltage

SKU Code	3326
Model No.	N/A
Description	5050 60 RGB + WHITE LED Controller
Max Current /Watt	N/A
Input Voltage	DC 12V
Size	N/A
EAN Code	3800230629630



DC12V Voltage

SKU Code	3327
Model No.	VT-2408
Description	RGB+W Amplifier
Max Current /Watt	N/A
Input Voltage	DC 12V
Size	N/A
EAN Code	3800157601047



DC12V Voltage

SKU Code	3328
Model No.	N/A
Description	360W RF Controller
Max Current /Watt	N/A
Input Voltage	DC 12V
Size	N/A
EAN Code	3800157601054



DC12V Voltage

SKU Code	3009
Model No.	N/A
Description	5050 RGB Strip Amplifier
Max Current /Watt	N/A
Input Voltage	DC 12V
Size	N/A
EAN Code	3800230622259



DC12V Voltage

SKU Code	3018
Model No.	N/A
Description	5050 RGB Strip Mini-Amplifier
Max Current /Watt	N/A
Input Voltage	DC 12V
Size	N/A
EAN Code	3800230622242

SMD LED MODULES



SKU Code	5007
Wattage	0.9W
Voltage	12V
LED TYPE	5050
COLOR	RGB
LED Qty	3
LM/LED	16
IP RATING	IP 65 15 x 93 x 8 mm
SIZE (L x B x H)	N/A
EAN CODE	



SKU Code	5008
Wattage	1.2W
Voltage	12V
LED TYPE	5050
COLOR	White
LED Qty	4
LM/LED	16
IP RATING	IP 65
SIZE (L x B x H)	35 x 46 x 4 mm
EAN CODE	N/A



SKU Code	5025	5026
Wattage	1.24W	1.24W
Voltage	12V	12V
LED TYPE	SAMSUNG 5630	SAMSUNG 5630
COLOR	White	Warm White
LED Qty	3	3
LM/LED	45	45
IP RATING	IP 65	IP 65
SIZE (L x B x H)	63.5 x 16 x 6.8 mm	63.5 x 16 x 6.8 mm
EAN CODE	3800230623812	3800230623829



SKU Code	5027
Wattage	1.24W
Voltage	12V
LED TYPE	5630
COLOR	Red
LED Qty	3
LM/LED	22
IP RATING	IP 65
SIZE (L x B x H)	63.5 x 16 x 6.8 mm
EAN CODE	3800230623836



SKU Code	5028
Wattage	1.24W
Voltage	12V
LED TYPE	5050
COLOR	RGB
LED Qty	3
LM/LED	29
IP RATING	IP 65
SIZE (L x B x H)	63.5 x 16 x 6.8 mm
EAN CODE	3800230623843



SKU Code	5029
Wattage	1.24W
Voltage	12V
LED TYPE	5630
COLOR	White
LED Qty	4
LM/LED	45
IP RATING	IP 65
SIZE (L x B x H)	63.5 x 16 x 6.8 mm
EAN CODE	3800230629869

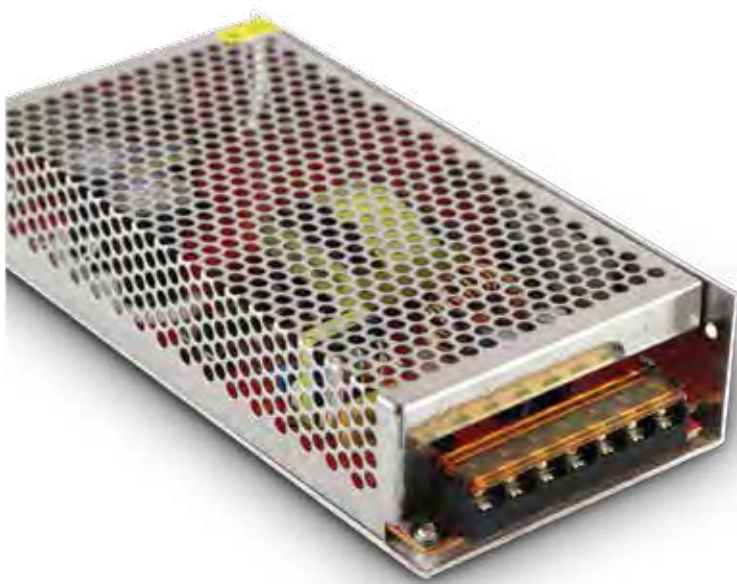

LED STRIP POWER SUPPLY METAL DRIVER (SMPS) SERIES

Product Features:

- Switching Metal Power Supply for all types of strip lights, led lighting , led display , etc
- With short circuit protection, over load protection , stable output voltage
- Built in EMI Filter
- High efficiency , low temperature
- 100% load tested
- Protection Rating : IP20
- CE, ROHS, EMC approved

MODEL	SKU CODE	WATTS POWER	CURRENT CAPACITY	OUTPUT	UNIT SIZE	EAN CODE
VT-20025	3050	25W	2.1A	12V	90 x 60 x 40 mm	3800230621726
VT-20040	3058	40W	3.3A	12V	108 x 78 x 35 mm	3800230625731
VT-20045	3051	45W	3.8A	12V	110 x 78 x 35 mm	3800230621733
VT-20060	3052	60W	5A	12V	160 x 98 x 38 mm	3800230621740
VT-20075	3053	75W	6A	12V	160 x 98 x 38 mm	3800230621757
VT-20080	3059	80W	6.6A	12V	160 x 98 x 40 mm	3800230625748
VT-20100	3060	100W	8.3A	12V	199 x 98 x 42 mm	3800230625755
VT-20120	3054	120W	10A	12V	199 x 98 x 42 mm	3800230621764
VT-20150	3055	150W	12.5A	12V	199 x 98 x 42 mm	3800230621771
VT-20200	3061	200W	16.5A	12V	200 x 110 x 50 mm	3800230625762
VT-20250	3056	250W	20A	12V	200 x 110 x 50 mm	3800230621788
VT-20350	3057	350W	30A	12V	215 x 115 x 50 mm	3800230621795
VT-20500	3062	500W	42A	12V	215 x 115 x 50 mm	3800157605984

LED STRIP POWER SUPPLY RAINPROOF POWER SUPPLY SERIES

Product Features :

- RAIN PROOF DRIVER for all types of STRIP LIGHTS, LED LIGHTING, LED DISPLAY, etc.
- Industrial specifications and standards.
- With short circuit protection, over load protection and stable output voltage.
- Built in EMI Filter.
- High efficiency and low temperature.
- 100% load tested.
- Protection Rating: IP44.
- CE, ROHS and EMC approved.



MODEL	SKU CODE	WATTS POWER	CURRENT CAPACITY	OUTPUT	UNIT SIZE	EAN CODE
VT-21060	3070	60W	5A	12V	155 x 105 x 50 mm	3800230621801
VT-21080	3069	80W	6.6A	12V	155 x 105 x 50 mm	3800230621818
VT-21080	3075	80W	3.3A	24V	155 x 102 x 46 mm	3800230621870
VT-21120	3071	120W	10A	12V	195 x 115 x 53 mm	3800230621825
VT-21150	3072	150W	12.5A	12V	195 x 115 x 53 mm	3800230621832
VT-21150	3076	150W	6.2A	24V	195 x 112 x 52 mm	3800230621880
VT-21200	3078	200W	8.3A	24V	195 x 112 x 50 mm	3800230621849
VT-21250	3073	250W	20A	12V	233 x 153 x 66 mm	3800230621856
VT-21300	3081	300W	25A	12V	233 x 153 x 66 mm	3800157601542
VT-21400	3074	400W	33A	12V	233 x 153 x 66 mm	3800230621863
VT-21400	3077	400W	16.6A	24V	232 x 153 x 65 mm	3800230621894



LED STRIP POWER SUPPLY
WATERPROOF POWER SUPPLY SERIES

Product Features :

- WATERPROOF DRIVER for all types of STRIP LIGHTS, LED LIGHTING, LED DISPLAY, etc.
- Industrial specifications and standards.
- With short circuit protection, over load protection and stable output voltage.
- Built in EMI Filter.
- High efficiency and low temperature.
- 100% load tested.
- Protection Rating: IP65.
- CE, ROHS, EMC approved.



MODEL	SKU CODE	WATTS POWER	CURRENT CAPACITY	OUTPUT	UNIT SIZE	EAN CODE
VT-22030	3100	30W	2.5A	12V	201 x 30.5 x 20 mm	3800230621900
VT-22045	3090	45W	3.75A	12V	250 x 40 x 23 mm	3800230621917
VT-22045	3095	45W	1.88A	24V	250 x 40 x 23 mm	3800230621979
VT-22060	3091	60W	5A	12V	180 x 72 x 45 mm	3800230621924
VT-22100	3092	100W	8.5A	12V	253 x 72 x 45 mm	3800230621931
VT-22120	3093	120W	10A	12V	253 x 72 x 45 mm	3800230621948
VT-22150	3094	150W	12.5A	12V	253 x 72 x 45 mm	3800230621955
VT-22150	3096	150W	6.25A	24V	253 x 72 x 45 mm	3800230621986
VT-22200	3097	200W	8.3A	24V	231 x 120 x 53 mm	3800230621993
VT-22200	3098	200W	16.6A	12V	200 x 120 x 53 mm	3800230625779
VT-22360	3099	360W	30A	12V	256 x 102 x 65 mm	3800230625786
VT-22020	3214	20W	0.83A	24V	201 x 30.5 x 20 mm	3800230621962
VT-22030	3215	30W	1.25A	24V	201 x 30.5 x 20 mm	3800230629562
VT-22101	3102	100W	4.2A	24V	201 x 30.5 x 20 mm	3800157605991
VT-22300	3219	300W	25A	12V	201 x 30.5 x 20 mm	3800157604932

LED STRIP POWER SUPPLY PLASTIC ADAPTOR SERIES

Product Features :



- Plastic DRIVER for all types of STRIP LIGHTS, LED LIGHTING, LED DISPLAY, etc.
- With specifications and Industrial standards.
- With short circuit protection, over load protection and stable output voltage.
- Built in EMI Filter.
- High efficiency and low temperature.
- 100% load tested.
- Protection Rating: IP 20.
- CE, Rosh, EMC approved.
- Options available with BS STANDARD 3 PIN PLUG.

MODEL	SKU CODE	WATTS POWER	CURRENT CAPACITY	OUTPUT	VOLTAGE / FREQUENCY	EAN CODE
VT-23018	3017	18W	1.5A	12V	AC 110-240V, 50/60Hz	3800230622006
VT-23030	3007	30W	2.5A	12V	AC 110-240V, 50/60Hz	3800230622013
VT-23042	3016	42W	3.5A	12V	AC 110-240V, 50/60Hz	3800230622020
VT-23060	3008	60W	5A	12V	AC 110-240V, 50/60Hz	3800230622037
VT-23080	3019	80W	6.5A	12V	AC 110-240V, 50/60Hz	3800230622044
VT-23040	3033	40W	3.3A	12V	AC 110-240V, 50/60Hz	3800230626745
VT-23002 W <small>With UK Standard, BS plug</small>	3030	24W	2A	12V	AC 85-240V, 50/60Hz	3800230625298
VT-23003 W <small>With UK Standard, BS plug</small>	3031	42W	3.5A	12V	AC 85-240V, 50/60Hz	3800230625304
VT-23005 W <small>With UK Standard, BS plug</small>	3032	60W	5A	12V	AC 85-240V, 50/60Hz	3800230625311



Plastic Adaptor Series (EMC Approved)



MODEL	SKU CODE	WATTS POWER	CURRENT CAPACITY	OUTPUT	VOLTAGE / FREQUENCY	EAN CODE
VT-23024	3036	24W	2A	12V	AC: 110-240V, 50/60Hz	3800157601474
VT-23060	3035	60W	5A	12V	AC: 110-240V, 50/60Hz	3800157601085
VT-23078	3034	78W	6.5A	12V	AC: 110-240V, 50/60Hz	3800157601078
VT-23024 W <small>With UK Standard, BS plug</small>	3038	24W	2A	12V	AC: 110-240V, 50/60Hz	3800157601535
VT-23060 W <small>With UK Standard, BS plug</small>	3037	60W	5A	12V	AC: 110-240V, 50/60Hz	3800157601528



LED TRACK LIGHTS

Perfect ecological alternative to Old Halogen Lights, Track lights are the extensive range of modern LED Track Lights! Delivering high performance, excellent durability and remarkable light output to serve the general Commercial and Retail market

PRODUCT FEATURES

- Available from 10W up to 45W
- Saves 80% energy
- No Ultraviolet or Infrared Rays
- Totally flexible, Compact & Adjustable design
- No Lead or Mercury content hence Environment friendly
- Provides Uniform Radiance & Enhances appeal of any environment
- Enhances measurable levels of performance as compared to older versions of high wattage halogen & HID light sources in retail & Commercial Lighting applications

APPLICATIONS

- Perfect choice for Exhibition Stands, Hotels, Bars, Commercial & Residential Lighting





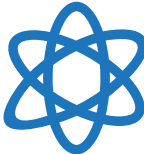

Experience The
True Colors with
CRI95 TRACKS

 **CRI**
>95

 **1800**
 LUMENS
33W
VT-4535

 **100W**
 EQUIVALENT

 **25°**
 BEAM ANGLE

1233 3000K Warmwhite
 1234 4500K Daywhite
 1235 6000K White

 **2300**
 LUMENS
45W
VT-4545

 **135W**
 EQUIVALENT

 **25°**
 BEAM ANGLE

1236 3000K Warmwhite
 1237 4500K Daywhite
 1238 6000K White

Model No	VT-4535	VT-4545
Watts	33W	45W
EQ. Watts	100W	135W
Voltage/Frequency	100-240V,50/60Hz	100-240V,50/60Hz
Luminous Flux	1800lm	2300lm
LED Type	COB	COB
CRI	>95	>95
PF	>0.9	>0.9
Beam Angle	25'D	25'D
Color of Fixture	Black	Black
Body Type	Die Cast Aluminum	Die Cast Aluminum
Dimension	112 x 165 x 205mm 	112 x 164 x 218mm 
EAN Code 3000K	3800157603720	3800157603751
EAN Code 4500K	3800157603737	3800157603768
EAN Code 6000K	3800157603744	3800157603775



23W
VT-4521T

N/A 3000K Warmwhite
N/A 4500K Daywhite
1202 6000K White

1500
LUMENS



23W
VT-4521T

N/A 3000K Warmwhite
N/A 4500K Daywhite
1201 6000K White

1500
LUMENS



Model No	VT-4521T	VT-4521T
Watts	23W	23W
EQ. Watts	100W	100W
Voltage/Frequency	AC: 100-240V, 50/60Hz	AC: 100-240V, 50/60Hz
Luminous Flux	1500lm	1500lm
LED Type	COB	COB
CRI	>80	>80
PF	> 0.9	> 0.9
Beam Angle	46°D	46°D
Color of Fixture	Black	White
Body Type	Die Cast Aluminum	Die Cast Aluminum
Dimension	80mm x 185mm	80mm x 185mm



EAN Code 3000K
EAN Code 4500K
EAN Code 6000K

N/A
N/A
3800157600187

N/A
N/A
3800157600170



2300
LUMENS

33W
VT-4534

1242 3000K Warmwhite
1231 4500K Daywhite
1232 6000K White



4300
LUMENS

48W
VT-4548T

N/A 3000K Warmwhite
N/A 4500K Daywhite
1200 6000K White



2300
LUMENS

33W
VT-4534

1241 3000K Warmwhite
1229 4500K Daywhite
1230 6000K White



4300
LUMENS

48W
VT-4548T

N/A 3000K Warmwhite
N/A 4500K Daywhite
1199 6000K White



Model No	VT-4534	VT-4548T	VT-4534	VT-4548T
Watts	33W	48W	33W	48W
EQ. Watts	100W	250W	100W	250W
Voltage/Frequency	220-240V, 50/60Hz	AC: 90-240V, 50/60Hz	220-240V, 50/60Hz	AC: 90-240V, 50/60Hz
Luminous Flux	2300lm	4300lm	2300lm	4300lm
LED Type	COB	SMD	COB	SMD
CRI	>80	> 80	>80	> 80
PF	>0.9	> 0.9	>0.9	> 0.9
Beam Angle	22'D	100'D	22'D	100'D
Color of Fixture	Black	Black	White	White
Body Type	Die Cast Aluminum	Die Cast Aluminum	Die Cast Aluminum	Die Cast Aluminum
Dimension	106 x 208 x 206mm	204 x 107 x 230mm	106 x 208 x 206mm	204 x 107 x 230mm
EAN Code 3000K	3800157604000	N/A	3800157603997	N/A
EAN Code 4500K	3800157602525	N/A	3800157602501	N/A
EAN Code 6000K	3800157602532	3800157600163	3800157602518	3800157600156



3250
LUMENS

45W
VT-4546

1249 3000K WarmWhite
1250 4500K DayWhite
1251 6000K White



3250
LUMENS

45W
VT-4546

1252 3000K WarmWhite
1253 4500K DayWhite
1254 6000K White



3450
LUMENS

35W
VT-4536

1255 3000K WarmWhite
1256 4500K DayWhite
1257 6000K White







2400
LUMENS

48W
VT-4540T

2600
LUMENS

1191 3000K Warmwhite
1192 4500K Daywhite
N/A 6000K White



Model No	VT-4546	VT-4546	VT-4536	VT-4540T
Watts	45W	45W	35W	40W
EQ. Watts	250W	250W	120W	200W
Voltage/Frequency	AC: 220-240V, 50/60Hz	AC: 220-240V, 50/60Hz	AC: 220-264V, 50/60Hz	AC: 220-240V, 50/60Hz
Luminous Flux	3250lm	3250lm	3450lm	2400lm/2600lm
LED Type	COB	COB	COB	SHARP/COB
CRI	> 80	> 80	> 80	>80
PF	> 0.95	> 0.95	> 0.9	> 0.9
Beam Angle	20'D	20'D	12'D/24'D	22'D
Color of Fixture	White	Black	White	Black
Body Type	PC + Aluminum	PC + Aluminum	Aluminum	Aluminum
Dimension	110 x 255mm	110 x 255mm	165 x 92 x 192	225 x 185 x 138mm
				
EAN Code 3000K	3800157607490	3800157607520	3800157607551	3800230629548
EAN Code 4500K	3800157607505	3800157607537	3800157607568	3800230629555
EAN Code 6000K	3800157607513	3800157607544	3800157607575	N/A

TRACK FITTINGS 2 LINE FITTINGS



SKU CODE 3546 **GU10 COMPATIBLE**
DESCRIPTION GU10 Fitting 2 Line White
EAN CODE 3800230628312



SKU CODE 3545 **GU10 COMPATIBLE**
DESCRIPTION GU10 Fitting 2 Line Black
EAN CODE 3800230628305



SKU CODE 3556 **PAR20 COMPATIBLE**
DESCRIPTION Par 20 Fitting 2 Line White
EAN CODE 3800230628411



SKU CODE 3555 **PAR20 COMPATIBLE**
DESCRIPTION Par 20 Fitting 2 Line Black
EAN CODE 3800230628404



SKU CODE 3550 **PAR30 COMPATIBLE**
DESCRIPTION Par30 Fitting 2 Line White
EAN CODE 3800230628350



SKU CODE 3549 **PAR30 COMPATIBLE**
DESCRIPTION Par30 Fitting 2 Line Black
EAN CODE 3800230628343



SKU CODE 3569 **PAR38 COMPATIBLE**
DESCRIPTION Par38 Fitting 2 Line White
EAN CODE 3800157604246



SKU CODE 3571 **PAR 20-30-38 COMPATIBLE**
DESCRIPTION 2 Line Track Wire White
EAN CODE 3800157604260



SKU CODE 3572 **PAR 20-30-38 COMPATIBLE**
DESCRIPTION 2 Line Track Wire Black
EAN CODE 3800157604277

4 LINE FITTINGS



**GU10
COMPATIBLE**

SKU CODE

3544

DESCRIPTION

GU10 Fitting 4 Line White

EAN CODE

3800230628299



**GU10
COMPATIBLE**

3543

GU10 Fitting 4 Line Black

3800230628282



**PAR20
COMPATIBLE**

3554

Par 20 Fitting 4 Line White

3800230628394



**PAR20
COMPATIBLE**

SKU CODE

3553

DESCRIPTION

Par 20 Fitting 4 Line Black

EAN CODE

3800230628381



**PAR30
COMPATIBLE**

3548

Par30 Fitting 4 Line White

3800230628336



**PAR30
COMPATIBLE**

3547

Par30 Fitting 4 Line Black

3800230628329



**PAR38
COMPATIBLE**

SKU CODE

3570

DESCRIPTION

Par38 Fitting 4 Line White

EAN CODE

3800157604252



**PAR
20-30-38
COMPATIBLE**

3573

4 Line Track Wire White

3800157604284



**PAR
20-30-38
COMPATIBLE**

3574

4 Line Track Wire Black

3800157604291



**GU10
TRACK FITTING**

SKU CODE

3617

DESCRIPTION

1 x GU10 Track Fitting White

EAN CODE

3800157607469



**GU10
TRACK FITTING**

3618

2 x GU10 Track Fitting White

3800157607476



**GU10
TRACK FITTING**

3619

3 x GU10 Track Fitting White

3800157607483

ACCESSORIES

SKU CODE	DESCRIPTION	EAN CODE
3557	130mm 4 Line Black	3800230628428
3558	130mm 4 Line White	3800230628435
3559	Flexible Joint 4 Line Black	3800230628442
3560	Flexible Joint 4 Line White	3800230628459
3514	2I Track Light Accessory Black	3800230626110
3516	2T Track Light Accessory Black	3800230626127
3517	2X Track Light Accessory Black	3800230626134
3515	2L Track Light Accessory Black	3800230626141
3519	2I Track Light Accessory White	3800230626158
3518	2X Track Light Accessory White	3800230626172
3520	2L Track Light Accessory White	3800230626189
3523	4I Track Light Accessory Black	3800230623195
3524	4T Track Light Accessory Black	3800230623201
3526	4X Track Light Accessory Black	3800230623218
3528	4L Track Light Accessory Black	3800230623225
3522	4I Track Light Accessory White	3800230623232
3525	4T Track Light Accessory White	3800230623249
3527	4X Track Light Accessory White	3800230623256
3529	4L Track Light Accessory White	3800230623263
9944	1 Meter Black 4 Core Track	3800230623133
9952	1.5 Meters Black 4 Core Track	3800230623140
9954	2 Meters Black 4 Core Track	3800230623157
9945	1 Meter White 4 Core Track	3800230623164
9953	1.5 Meters White 4 Core Track	3800230623171
9955	2 Meters White 4 Core Trac	3800230623188
3565	Hanging Track Line Kit 1Meter Black	3800157600019
3566	Hanging Track Line Kit 1Meter White	3800157600026
3567	E27 FITTING 4 LINE WHITE	3800157602402
3568	E27 FITTING 2 LINE WHITE	3800157602419

3514



3515



3516



3519



3517



3520



3528



3523



3522



3525



3529



3526



3518



3527



3521



3524



3566

9945



9953

LED COB DOWNLIGHTS

Swap outdated CFL Lights with high quality LED Down Lights for long- lasting energy efficiency and instant brightness. Choose from a wide range of 3W to 40W

PRODUCT FEATURES

- Innumerable styles & Elegant appearance
- Non - Flickering
- No UV Radiation
- Best Quality LED Chips from companies like CREE & SAMSUNG
- Premium Quality Power Driver with lowest power factor saver & high RA
- Easy Installation
- Varied finishes with strong die cast Aluminium body
- Low Maintenance
- All down lights come with premium quality power

APPLICATIONS

- Residences, Showrooms, Hotels & Boutiques etc.





10W
VT-2610 **730**
LUMENS
1102 3000K Warmwhite
1101 4500K Daywhite
1100 6000K White

20W
VT-2620 **1500**
LUMENS
1108 3000K Warmwhite
1104 4500K Daywhite
1103 6000K White

30W
VT-2630 **2400**
LUMENS
1107 3000K Warmwhite
1106 4500K Daywhite
1105 6000K White

40W
VT-2645 **3200**
LUMENS
1163 3000K Warmwhite
1164 4500K Daywhite
1165 6000K White

Model No.	VT-2610	VT-2620	VT-2630	VT-2645
Watts	10W	20W	30W	40W
EQ. Watts	25W	50W	75W	100W
Voltage/Frequency	AC: 220-240V, 50Hz	AC: 220-240V, 50Hz	AC: 220-240V, 50Hz	AC: 220-240V, 50Hz
Luminous Flux	730lm	1500lm	2400lm	3200lm
LED Type	COB	COB	COB	COB
CRI	≥80	≥80	≥80	≥80
PF	> 0.9	> 0.9	> 0.9	> 0.9
Beam Angle	120'D	120'D	120'D	120'D
Body Type	PKW (White)	PKW (White)	PKW (White)	PKW (White)
Shape	Round	Round	Round	Round
Dimension	Ø 135mm x 71mm	Ø 182mm x 90mm	Ø 222mm x 111mm	Ø 222mm x 111mm
Cutting Size	D=Ø105mm	D=Ø160mm	D=Ø205mm	D=Ø205mm



EAN Code 3000K
EAN Code 4500K
EAN Code 6000K

3800230622396
3800230622389
3800230622372

3800230625410
3800230622419
3800230622402

3800230625021
3800230622433
3800230622426

3800230627285
3800230627292
3800230627308

IP65



390
LUMENS

6W
VT-2906 RD

1162 3000K Warmwhite
N/A 4500K Daywhite
1154 6000K White



IP65



390
LUMENS

6W
VT-2906 SQ

1161 3000K Warmwhite
N/A 4500K Daywhite
1153 6000K White



2100
LUMENS

35W
VT-7035

1091 3000K Warmwhite
1092 4500K Daywhite
1093 6000K White

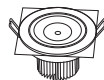
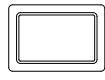

IP65

Model No.	VT-2906 RD	VT-2906 SQ	VT-7035
Watts	6W	6W	35W
EQ. Watts	15W	15W	80W
Voltage/Frequency	AC:200~240V, 50/60Hz	AC:200~240V, 50/60Hz	AC: 85-265V, 50/60Hz
Luminous Flux	390lm	390lm	2100lm
LED Type	COB	COB	SMD
CRI	> 80	> 80	> 70
PF	> 0.5	> 0.5	> 0.9
Beam Angle	21'D	21'D	160'D
Body Type	Powder Coating Aluminum	Powder Coating Aluminum	Powder Coating Aluminum
Shape	Round	Square	Rectangle
Dimension	Φ90mm x 61mm	90 x 90 x 61mm	170 x 264 x 64mm
Cutting Size	D=Φ80mm	80x80mm	225 x 150mm
			
EAN Code 3000K	3800230626943	3800230626936	3800230626226
EAN Code 4500K	N/A	N/A	3800230626233
EAN Code 6000K	3800230626691	3800230626684	3800230626240



3W
VT-1109 RD

1207 3000K Warmwhite
 1208 4500K Daywhite
 N/A 6000K White



3W
VT-1109 SQ



1209 3000K Warmwhite
 1210 4500K Daywhite
 1223 6000K White



5W
VT-1005 RD

1239 3000K Warmwhite
 N/A 4500K Daywhite
 1240 6000K White



Model No.	VT-1109 RD	VT-1109 SQ	VT-1005 RD
Watts	3W	3W	5W
EQ. Watts	12W	12W	30W
Voltage/Frequency	AC: 100-240V, 50/60Hz	AC: 100-240V, 50/60Hz	AC: 100-240V, 50/60Hz
Luminous Flux	120lm	120lm	350lm
CRI	> 80	> 80	>80
PF	> 0.5	> 0.5	>0.5
Beam Angle	15'D	15'D	60'D
Color of Fixture	PKW (White)	PKW (White)	PKW
Body Type	Aluminum	Aluminum	Aluminum
Shape	Round	Square	Round
Dimension	Ø80 x 51mm	80 x 80 x 51mm	Ø88 x 40mm
Cutting Size	D=Ø62mm	62 x 62mm	D= Ø72mm
			
EAN Code 3000K	3800157600231	3800157600255	3800157603782
EAN Code 4500K	3800157600248	3800157600262	N/A
EAN Code 6000K	N/A	3800157601504	3800157603799



550
LUMENS
8W
VT-2908 RD

1116 3000K Warmwhite
1117 4500K Daywhite
1118 6000K White



550
LUMENS
8W
VT-2908 SQ

1113 3000K Warmwhite
1114 4500K Daywhite
1115 6000K White



Model No.

Watts
EQ. Watts
Voltage/Frequency
Luminous Flux
LED Type
CRI
PF
Beam Angle
Body Type
Shape
Dimension
Cutting Size

VT-2908 RD

8W
32W
AC: 100-240V, 50/60Hz
550lm
COB
≥80
> 0.8
24'D
Powder Coating Diecast
Round
Ø103 x 75mm
D=Ø80mm



3800230625144
3800230625151
3800230625168

VT-2908 SQ

8W
32W
AC: 100-240V, 50/60Hz
550lm
COB
≥80
> 0.8
24'D
Powder Coating Diecast
Square
103 x 103 x 75mm
80 x 80mm



3800230625175
3800230625182
3800230625199

EAN Code 3000K
EAN Code 4500K
EAN Code 6000K



7W
VT-2807 N/A 3000K Warmwhite
1110 4500K Daywhite
N/A 6000K White



22W
VT-2822 N/A 3000K Warmwhite
1111 4500K Daywhite
N/A 6000K White



30W
VT-2830 N/A 3000K Warmwhite
1112 4500K Daywhite
N/A 6000K White



Model No.	VT-2807	VT-2822	VT-2830
Watts	7W	22W	30W
EQ. Watts	18W	55W	75W
Voltage/Frequency	AC: 170-240V, 50/60Hz	AC: 170-240V, 50/60Hz	AC: 170-240V, 50/60Hz
Luminous Flux	550lm	1570lm	2100lm
LED Type	COB.CREE	COB.CREE	COB.CREE
CRI	>80	>80	>80
PF	> 0.8	> 0.8	> 0.9
Beam Angle	20'D	25'D	25'D
Body Type	Ivory White	Ivory White	Ivory White
Shape	Zoom	Zoom	Zoom
Dimension	Ø100 x 76mm	Ø158 x 150mm	Ø190 x 160mm
Cutting Size	D=Ø86mm	D=Ø140mm	D=Ø175mm
			
EAN Code 3000K	N/A	N/A	N/A
EAN Code 4500K	3800230622440	3800230622457	3800230622464
EAN Code 6000K	N/A	N/A	N/A

ZOOM
FITTINGS



2000
LUMENS



20W 1017 3000K Warmwhite
1187 4500K Daywhite
VT-2720 1018 6000K White



4000
LUMENS



48W N/A 3000K Warmwhite
1197 4500K Daywhite
VT-1748 N/A 6000K White



2400
LUMENS



30W 1193 3000K Warmwhite
1070 4000K Daywhite
VT-4530 1032 6000K White



5700
LUMENS



60W N/A 3000K Warmwhite
N/A 4500K Daywhite
VT-4560 1198 6000K White

Model No.	VT-2720	VT-1748	VT-4530	VT-4560
Watts	20W	48W	30W	60W
EQ. Watts	80W	250W	120W	300W
Voltage/Frequency	AC: 165-265V, 50/60Hz	AC: 90-240V, 50/60Hz	AC: 165-265V, 50/60Hz	AC: 90-240V, 50/60Hz
Luminous Flux	2000lm	4000lm	2400lm	5700lm
LED Type	COB	COB	COB	SMD
CRI	≥80	>80	>80	> 80
PF	> 0.7	> 0.9	> 0.9	> 0.9
Beam Angle	60'D	48'D	60'D	100'D
Body Type	Aluminum (PKW)	Aluminum	Aluminum, White	Aluminum
Shape	Round.Zoom	Round	Rectangle.Zoom	Rectangle
Dimension	Ø204 x 125mm	Ø250 x 145mm	241 x 154 x 92mm	240 x 145 x 165mm
Cutting Size	D=Ø175mm	D=Ø205mm	132 x 200mm	215 x 215mm
EAN Code 3000K	3800230626561	N/A	3800230629937	N/A
EAN Code 4500K	3800230628534	3800157600132	3800230622365	N/A
EAN Code 6000K	3800230626585	N/A	3800230622358	3800157600149





LED DOME LIGHTS

Introducing a customized innovation to an old problem LED DOME LIGHTS, Compact and Easy to install elegant replacement for traditional full round Dome Lights, Creates a perfect fusion between bright and dark spots for ambience of any environment

PRODUCT FEATURES

- 80% Electricity savings as compared to traditional Incandescent Bulbs
- 20,000 hours Lifespan
- Non - Flickering
- No UV Radiation
- Easy Installation
- Premium Quality LED Chip
- Premium Quality Power Driver
- Instant start 0-100% in 0 seconds
- Extreme Weather toleration (-20 to + 45 Degrees Centigrade)

APPLICATIONS

- Mostly used in Parking Lots, Passage's in big areas, Exterior Walls of Prestigious Buildings for ambience, Airports, Ports and Malls





Max. **60W**
VT-8002C 4966
Time Delay
Adjustable



12W
VT-8008 **IP66**



N/A 3000K Warmwhite
4984 4500K Daywhite
4985 6000K White





12W
VT-8008 **IP66**



4981 3000K Warmwhite
4971 4500K Daywhite
4980 6000K White



Model No.	VT-8002C	VT-8008	VT-8008
Sensor Type	Microwave	Microwave	Microwave
Color	White	White	Black
Detection Range	360°D	Max.(0 x H): 10m x 4m, 360°D	Max.(0 x H): 10m x 4m, 360°D
Voltage	AC: 220-240V,50Hz	AC: 200-240V,50/60Hz	AC: 200-240V,50/60Hz
Rated Load	Uses Max. 60W(E27)	12W	12W
EQ. Watts		60W	60W
Detection Distance	*1-8m (radius)	*10%/50%/100%	*10%/50%/100%
Time Delay	*10 sec to 12 min	10s/lmin/5min/10min/30min	*10s/lmin/5min/10min/30min
Luminous Flux	1300lm	840lm	840lm
Body Type	PC Cover	Plastic Clad Aluminum	Plastic Clad Aluminum
IP Rating	IP44	IP66	IP66
Dimension	Ø296 x 96mm	Ø300 x 100mm	Ø300 x 100mm
			
EAN Code 3000K		N/A	3800230629586
EAN Code 4500K	3800230625816	3800157601290	3800230629036
EAN Code 6000K		3800157601306	3800230629579



12W
VT-8017

5057 3000K Warmwhite
5058 4500K Daywhite
5059 6000K White



Model No.	VT-8017
Sensor Type	IR Sensor
Color	White
Detection Range	360°D
Voltage	AC: 200-240V, 50Hz
Rated Load	12W (24PCS LED)
EQ. Watts	60W
Detection Distance	max.6m(<24°C)
Time Delay	*10 sec to 3 min
Luminous Flux	800lm
Body Type	Plastic Clad Aluminum
IP Rating	IP20
Dimension	Ø290 x 60mm



EAN Code 3000K	3800157605250
EAN Code 4500K	3800157605267
EAN Code 6000K	3800157605274





12W
VT-8006

N/A 3000K Warmwhite
4969 4500K Daywhite
N/A 6000K White



12W
VT-8007

N/A 3000K Warmwhite
4970 4500K Daywhite
N/A 6000K White



12W
VT-8009

N/A 3000K Warmwhite
4972 4500K Daywhite
N/A 6000K White



12W
VT-8010

N/A 3000K Warmwhite
4973 4500K Daywhite
N/A 6000K White



Model No.	VT-8006	VT-8007	VT-8009	VT-8010
Watts	12W	12W	12W	12W
EQ. Watts	40W	40W	40W	40W
Voltage/Frequency	AC: 200-240V,50/60Hz	AC: 200-240V,50/60Hz	AC: 200-240V,50/60Hz	AC: 200-240V,50/60Hz
Luminous Flux	840lm	840lm	840lm	840lm
IP Rating	IP66	IP66	IP66	IP66
CRI	>70	>70	>70	>70
PF	>0.9	>0.9	>0.9	>0.9
Beam Angle	110°D	110°D	110°D	110°D
Color of Fixture	Black	Black	Black	Black
Body Type	Plastic Clad Aluminum	Plastic Clad Aluminum	Plastic Clad Aluminum	Plastic Clad Aluminum
Shape	Half-Round	Full-Round	Half-Oval	Full-Oval
Dimension	Ø300 x 100mm	Ø300 x 100mm	290 x 200 x 100mm	290 x 200 x 100mm
EAN Code 3000K	N/A	N/A	N/A	N/A
EAN Code 4500K	3800230629012	3800230629029	3800230629043	3800230629050
EAN Code 6000K	N/A	N/A	N/A	N/A



8W
VT-8014

4999 3000K Warmwhite
N/A 4500K Daywhite
4997 6000K White



12W
VT-8015

4998 3000K Warmwhite
5050 4500K Daywhite
4996 6000K White



12W
VT-8016

N/A 3000K Warmwhite
5054 4500K Daywhite
5053 6000K White



12W
VT-8007

N/A 3000K Warmwhite
4983 4500K Daywhite
N/A 6000K White



Model No.	VT-8014	VT-8015	VT-8016	VT-8007
Watts	8W	12W	12W	12W
EQ. Watts	20W	40W	40W	40W
Voltage/Frequency	AC: 200-240V, 50Hz	AC: 200-240V, 50Hz	AC: 200-240V, 50Hz	AC: 200-240V, 50/60Hz
Luminous Flux	560lm	840lm	840lm	840lm
IP Rating	IP66	IP66	IP66	IP66
CRI	>70	>70	>70	>70
PF	>0.5	>0.5	>0.5	>0.9
Beam Angle	120°D	120°D	120°D	110°D
Color of Fixture	White	White	White	White
Body Type	Plastic Clad Aluminum	Plastic Clad Aluminum	Plastic Clad Aluminum	Plastic Clad Aluminum
Shape	Round	Round	Oval	Full-Round
Dimension	Ø178 x 80mm	Ø220 x 105mm	245 x 165 x 96mm	Ø300 x 100mm

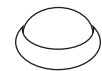

EAN Code 3000K
EAN Code 4500K
EAN Code 6000K

3800157602556
N/A
3800157602259

3800157602549
3800157603294
3800157602228

N/A
3800157603331
3800157603324

N/A
3800157601283
N/A



12W
VT-8006

N/A 3000K Warmwhite
4986 4500K Daywhite
N/A 6000K White



12W
VT-8015

N/A 3000K Warmwhite
5052 4500K Daywhite
5051 6000K White



12W
VT-8016

N/A 3000K Warmwhite
5056 4500K Daywhite
5055 6000K White



Model No.	VT-8006	VT-8015	VT-8016
Watts	12W	12W	12W
EQ. Watts	40W	40W	40W
Voltage/Frequency	AC: 200-240V,50/60Hz	AC: 200-240V, 50Hz	AC: 200-240V, 50Hz
Luminous Flux	840lm	840lm	840lm
IP Rating	IP66	IP66	IP66
CRI	>70	>70	>70
PF	>0.9	>0.5	>0.5
Beam Angle	110°D	120°D	120°D
Color of Fixture	White	Black	Black
Body Type	Plastic Clad Aluminum	Plastic Clad Aluminum	Plastic Clad Aluminum
Shape	Half-Round	Round	Oval
Dimension	Ø300 x 100mm	Ø220 x 105mm	245 x 165 x 96mm
EAN Code 3000K	N/A	N/A	N/A
EAN Code 4500K	3800157601313	3800157603317	3800157603980
EAN Code 6000K	N/A	3800157603300	3800157603348



MOTION SENSORS

Many areas like lobbies, parking garages, staircases remain unused for long hours, but do need lighting to be lit automatically in case of movement. A motion sensor is a device which detects movements, and in some cases light conditions and then transmits a signal for illumination.

PRODUCT FEATURES

- Power saving
- Available for in-door and out door purposes
- Compatible with most of our models
- Proven quality from reliable suppliers
- Wide range of models to choose from

APPLICATIONS

- Outdoor Areas like parking garages, Gardens compounds and yards
- Indoor areas like walkways, lobbies and staircases.





Max. **60W**
VT-8005 4982
Time Delay
Adjustable



••• **IP44**

Max. **300W**
VT-8003 4967
Time Delay
Adjustable



••• **IP44**

Max. **300W**
VT-8003 5077
Time Delay
Adjustable



Model No.	VT-8005	VT-8003	VT-8003
Sensor Type	Infrared	Infrared	Infrared
Color	White	White	Black
Detection Range	360°D	180°D	180°D
Voltage	AC: 110-240V,50/60Hz	AC: 220-240V,50Hz	AC: 220-240V,50Hz
Rated Load	Max.60W(E27)	Max.300W	Max.300W
Detection Distance	Max.6m (<24° C)	max.12m (<24° C)	max.12m (<24° C)
Time Delay	*10sec±3sec-5min±1 min	*10 sec to 7min	*10 sec to 7min
Ambient Light	*<3-2000LUX	*<3-2000LUX	*<3-2000LUX
Body Type	Plastic	PC	PC
Detector	/	One	One
IP Rating	IP20	IP44	IP44
Dimension	Ø55.5 x 116.5mm	86.4 x 60.4 x 98mm	86.4 x 60.4 x 98mm



EAN Code

3800157600071

3800230625823

3800157606875



Max. **300W**
VT-8004

4968
Time Delay
Adjustable



Max. **300W**
VT-8018

5078
Time Delay
Adjustable



IP65
VT-8021

5079
HOUSING FOR
MICROWAVE SENSOR

SENSOR
INSIDE

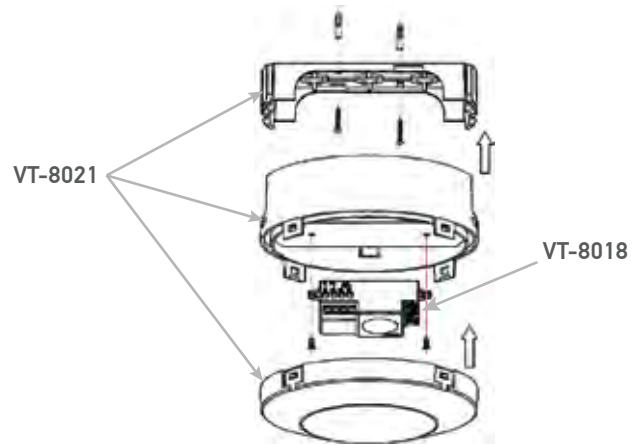

Model No.	VT-8004	VT-8018	VT-8021
Sensor Type	Infrared	Microwave	Microwave
Color	White	White	White
Detection Range	360°D	180°/360°D	-
Voltage	AC: 220-240V,50Hz	AC: 220-240V,50/60Hz	-
Rated Load	Max.300W	Max.300W	-
Detection Distance	max.12m (<24° C)	*1-8m (radius)	-
Time Delay	*10 sec to 7 min	*5 sec to 15 min	-
Ambient Light	*<3-2000LUX	*<3-2000LUX	-
Body Type	PC	Plastic	Plastic
Detector	Three	One	-
IP Rating	IP44	IP20	IP65
Dimension	88 x 55mm	37 x 25 x 61.5mm	Φ134 x 66.5mm



EAN Code **3800230625830**

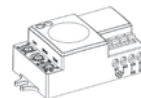

3800157606882



3800157606899



IP44 5081
Time Delay
Adjustable
VT-8019

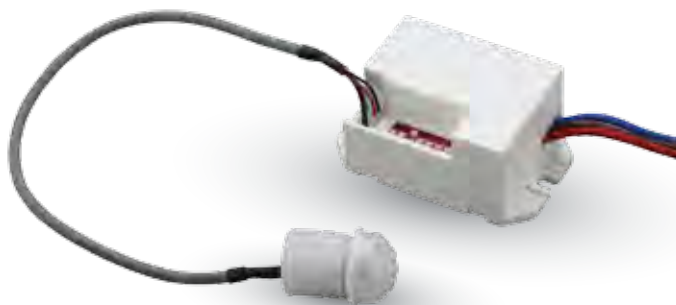

Max. **800W** 5082
Time Delay
Adjustable
VT-8022



Max. **1200W** 5083
Time Delay
Adjustable
VT-8023



Model No.	VT-8019	VT-8022	VT-8023
Sensor Type	Photocell	IR Motion	Microwave
Color	White	White	White
Detection Range	360°D	120°/360°D	180°D
Voltage	AC: 110-240V, 50/60Hz	AC: 110-240V, 50/60Hz	AC: 220-240V, 50/60Hz
Rated Load	-	Max.500/800W	Max.1200W
Detection Distance	-	3m/6m(choice) (<24°C)	*5m - 15m
Time Delay	-	*5 sec to 8 min	*10 sec to 12 min
Ambient Light	*<5-15LUX	*<10-2000LUX	*<3-2000LUX
Body Type	Plastic	Plastic	Plastic
Detector	One	One	One
IP Rating	IP44	IP20	IP20
Dimension	35.5 x 46 x 44.1mm	36.8 x 25.5 x 55.4mm	80 x 80 x 32mm



EAN Code **3800157608015**



EAN Code **3800157608022**

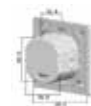

EAN Code **3800157608039**



Max. **300/500W** 5084
VT-8025 ON/OFF VIA
MOVING HAND



Max. **300/500W** 5085
VT-8026 ON/OFF VIA THE OPENING
AND CLOSING OFF THE DOOR



Model No.	VT-8025	VT-8026
Sensor Type	Motion	Motion
Color	White	White
Detection Range	-	-
Voltage	AC: 110-240V, 50/60Hz	AC: 110-240V, 50/60Hz
Rated Load	Max.300/500W	Max.300/500W
Detection Distance	5cm/6cm (<24°C)	5cm/6cm (<24°C)
Time Delay	-	-
Ambient Light	-	-
Body Type	Plastic	Plastic
Detector	One	One
IP Rating	IP20	IP20
Dimension	35.5 x 78.2 x 18.7mm	35.5 x 78.2 x 18.7mm

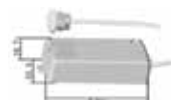

EAN Code

3800157608046

3800157608053



LED OUTDOOR LIGHTS

Transform the exteriors of a Building or a Garden into a Beautiful piece of Architecture. Simultaneously help navigate obstacles at night, prevent accidents and provide security

PRODUCT FEATURES

- Perfect replacement for traditional fittings as they are more flexible & efficient
- Work perfectly in extreme temperatures from -20° to $+45^{\circ}$ without any adverse effects
- Specifically designed for Outdoor use
- IP65/67 Protection Rating to ensure safety
- Low Maintenance
- Outstanding Colour options and settings

APPLICATIONS

- Used for Gardens, Outdoor Residential Areas, Walkways & Passages, Driveways, Fountains, Lawns, Entrance, Patio or Terrace and similar environments





IP65
VT-721 UG

4791
Type: Underground



IP65
VT-722

4793
Type: Wall



IP67
VT-723 UG

4792
Type: Underground



IP44
VT-726

7032
Type: Wall

Model No.	VT-721 UG	VT-722	VT-723 UG	VT-726
Type	Underground	Wall	Underground	Wall
Suitable	LED Fitting	LED Fitting	LED Fitting	LED Fitting
Holder	GU10	GU10	GU10	E27
Material	Aluminum, 304SS, Glass	304SS, Glass	Aluminum, 304SS, Glass	304SS Lampbody, Frosted PC
Color	Black Lamp Body	Silver	Black Lamp Body	Satin Nickle
IP Rating	IP65	IP65	IP67	IP44
Dimension	101 x 109 x 145mm	D=Ø60mm H=156mm	D= ø95mm H=317mm	D=Ø102mm H=200mm

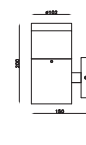
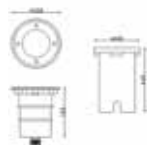

EAN Code

3800230625267

3800230625281

3800230625267

3800157603713



18W 5103 RGB
VT-1233 5106 3000K Warmwhite
5102 6000K White

100W
EQUIVALENT

GLASS
BODY TYPE

120°
BEAM ANGLE

 **IP68**



18W N/A RGB
VT-1235 5105 3000K Warmwhite
5104 6000K White

100W
EQUIVALENT

180°
BEAM ANGLE

MOUNTED
SURFACE

 **IP68**

Model No.

Watts

EQ. Watts

Voltage/Frequency

Luminous Flux

Beam Angle

Body Type

IP Rating

Dimension

VT-1233

18W

100W

AC:12V,50/60Hz

1100lm

120°D

Thick Glass

IP68

D:168mm x H:105mm

VT-1235

18W

100W

AC:12V,50/60Hz

1100lm

180°D

PVC Case

IP68

D:298mm x H:76mm

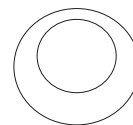
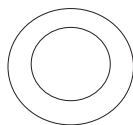

EAN Code 3000K
EAN Code 4500K
EAN Code 6000K

3800157601115
3800230627124
3800230627117

3800157601108
N/A
3800157601092

LED TABLE LAMPS

Our most cozy and favorite corners, be it at work or at home, while you are working, or relaxing and reading a book, always deserve the best lighting conditions. To cater to this need we bring to you an exclusive range of LED table lamps. designed with a touch of class, these lamps deliver very smooth lighting with suitable functions to set the right mood and ambiance.

PRODUCT FEATURES

- Energy efficient ways of keeping it that way.
- Adjustable direction
- Multiple functions like dimming, color changing.
- With USB charging functionality.
- Sleek and modern design

APPLICATIONS

• Table lamps can be used in any space, though they are most often found in bedrooms, living rooms at home next to sofas, chairs or beds. it is also a good accessory to be a part of the office decor.





120°
BEAM ANGLE

DIMMABLE

7W
VT-1007D

7034 { 3000K Warmwhite
4500K Daywhite
6000K White



120°
BEAM ANGLE

DIMMABLE

7W
VT-1007D

7042 { 3000K Warmwhite
4500K Daywhite
6000K White



120°
BEAM ANGLE

DIMMABLE

7W
VT-1007D

7043 { 3000K Warmwhite
4500K Daywhite
6000K White



Model No.	VT-1007D	VT-1007D	VT-1007D
Watts	7W	7W	7W
Voltage	AC: 100-240V, 50/60Hz	AC: 100-240V, 50/60Hz	AC: 100-240V, 50/60Hz
Lumens	400lm	400lm	400lm
IP Rating	IP20	IP20	IP20
CRI	> 80	> 80	> 80
PF	>0.45	>0.45	>0.45
Beam Angle	120'D	120'D	120'D
Color of Fixture	Grey	Pink	Blue
Body Type	ABS	ABS	ABS
Size	170 x 415 x 135mm	170 x 415 x 135mm	170 x 415 x 135mm

EAN Code 3000K }
 EAN Code 4500K }
 EAN Code 6000K }

3800157603836

3800157605311

3800157605328



120°
BEAM ANGLE

DIMMABLE

7W
VT-1009

COLOR CHANGEABLE

7039 { 3000K Warmwhite
4500K Daywhite
6000K White



120°
BEAM ANGLE

DIMMABLE

7W
VT-1009

COLOR CHANGEABLE

7040 { 3000K Warmwhite
4500K Daywhite
6000K White



120°
BEAM ANGLE

DIMMABLE

7W
VT-1008D

USB CHARGING

7035 { 3000K Warmwhite
4500K Daywhite
6000K White



120°
BEAM ANGLE

DIMMABLE

10W
VT-1010D

COLOR CHANGEABLE

7033 { 3000K Warmwhite
4500K Daywhite
6000K White

Model No.	VT-1009	VT-1009	VT-1008D	VT-1010D
Watts	7W	7W	7W	10W
Voltage	AC: 100-240V, 50/60Hz	AC: 100-240V, 50/60Hz	AC: 100-240V, 50/60Hz	AC: 100-240V, 50/60Hz
Lumens	650lm	650lm	400lm	700lm
IP Rating	IP20	IP20	IP20	IP20
CRI	> 80	> 80	> 80	> 80
PF	>0.45	>0.45	>0.45	>0.45
Beam Angle	120°D	120°D	120°D	120°D
Color of Fixture	White	Black+White	White	White with Silver
Body Type	ABS+Aluminum	ABS+Aluminum	ABS	ABS+Aluminum
Size	240 x 396 x 180mm	240 x 396 x 180mm	170 x 352 x 113mm	325 x 425 x 205mm

EAN Code 3000K
EAN Code 4500K
EAN Code 6000K

3800157605281

3800157605298

3800157603843

3800157603829

**WITH BUILT-IN
BATTERY PACK**



58W N/A 3000K Warmwhite
VT-558 7028 4500K Daywhite
7029 6000K White



17W N/A 3000K Warmwhite
VT-517 7030 4500K Daywhite
7031 6000K White

Model No.	VT-558	VT-517
Watts	58W	17W
Voltage	AC: 220-240V, 50/60Hz	AC: 220-240V, 50/60Hz
Lumens	5000lm	1300lm
LED Chip	SMD	SMD
*EM Discharge Current	0.6-0.7A	0.4-0.5A
*EM Output Current	170±5% MA	50±5% MA
**CM Charging Current	120MA	80MA
**CM Input Current	(AC240V) 20-30MA	(AC240V) 20-30MA
Charging Time	≥24 Hours	≥24 Hours
Working Time	≥3 HOURS	≥3 HOURS
Battery Capacity	2.2AH(2200MAH) 7.2V	1.5AH(1500MAH) 6V
CRI	> 80	> 80
PF	>0.9	>0.9
Beam Angle	120°D	120°D
IP Rating	IP66	IP65
Body Type	Plastic Clad Aluminum	Plastic Clad Aluminum
Size	1565 x 130x 92mm	Ø305mm x 84mm

EAN Code 3000K
EAN Code 4500K
EAN Code 6000K

N/A
3800157603614
3800157603621

N/A
3800157603638
3800157603645

PRESENCE IN
COUNTRIES **50**

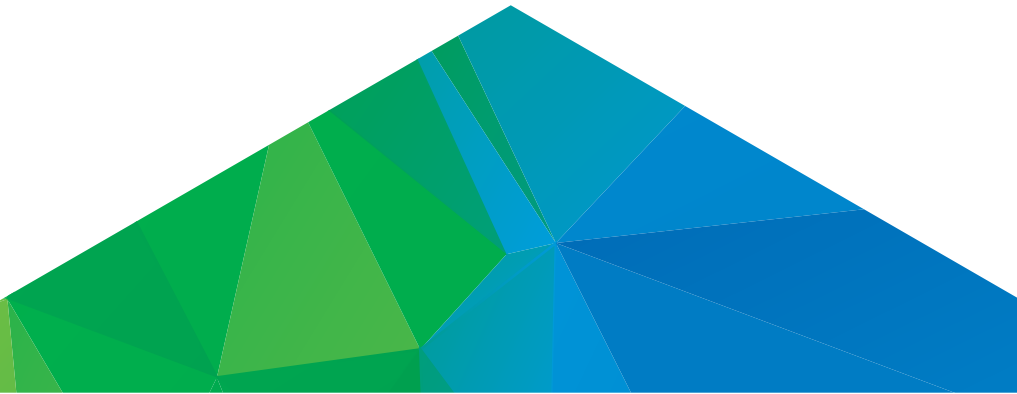

EUROPE OFFICE

V-TAC EUROPE LTD
Sofia Bulgaria

UK OFFICE

V-TAC UK LTD
London (United Kingdom)

INDIA OFFICE

V-TAC TECHNOLOGIES INDIA

HONG KONG OFFICE

V-TAC EXPORTS LTD

www.v-tac.eu | www.v-tac.co.uk | www.vtacexports.com