

## Fișă tehnică | Număr articol: 231-152/001-000

THT male header; 1.0 x 1.0 mm solder pin; straight; Pin spacing 5 mm; 22-pole; gray

[www.wago.com/231-152/001-000](http://www.wago.com/231-152/001-000)

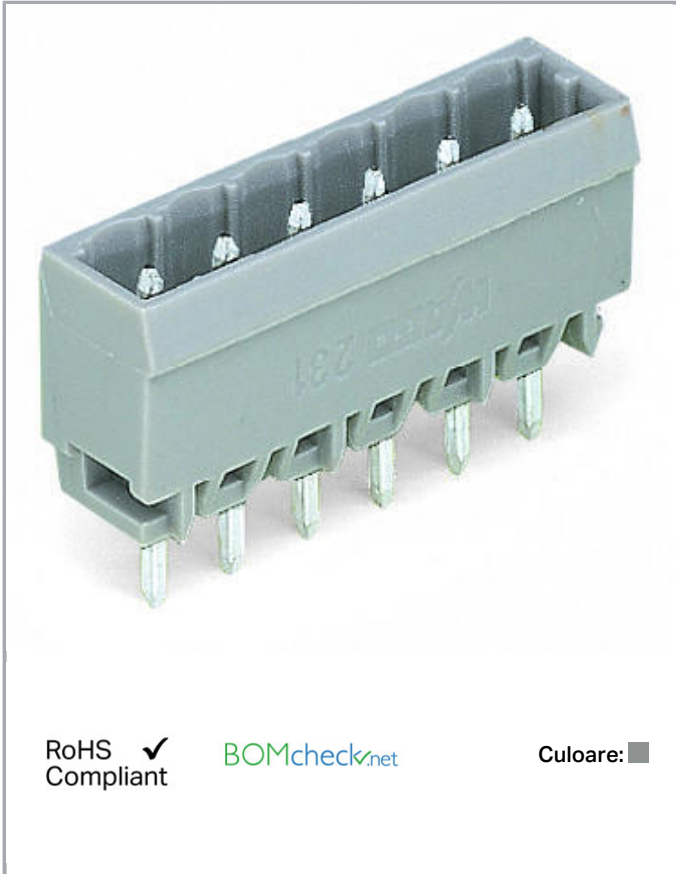

Supus modificărilor.

WAGO Kontakttechnik GmbH & Co. KG  
/Representative Office Romania  
Sos. Pipera-Tunari nr. 1/1  
building 1, 2nd floor | 077190 Voluntari, Ilfov  
Tel.: +40-(0)31 421 85 68 | Email: info-RO@wago.com

Aveți întrebări despre produsele noastre?  
Vă stăm la dispoziție pentru preluarea apelului la +40 (0) 31 421 85 68.

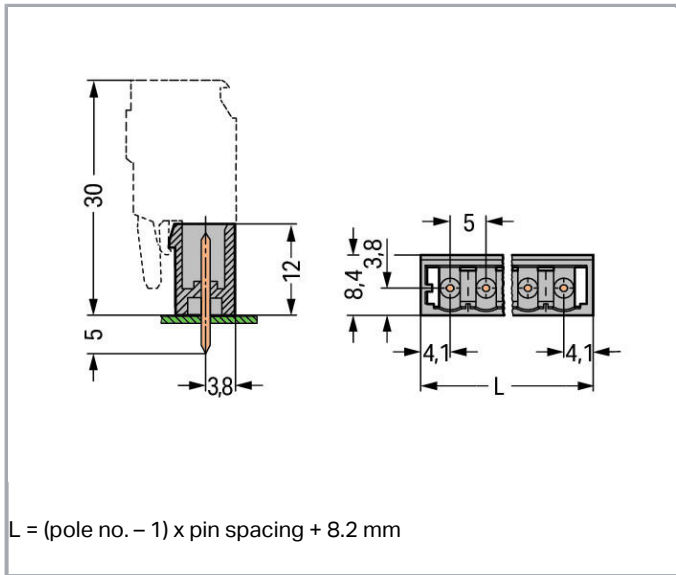

## Descriere articol

- Horizontal or vertical PCB mounting via straight or angled solder pins
- Pin cross-section: 1 x 1 mm
- With coding fingers

### Safety information 1:

The *MULTI CONNECTION SYSTEM (MCS)* is designed without breaking capacity for compliance with DIN EN 61984. When used as intended, MCS Connectors shall not be connected/disconnected when live or under load. The circuit design should ensure header pins, which can be touched, are not live when unmated.

## Date

### Electrical data

#### Ratings per IEC/EN 60664-1

Ratings per	IEC/EN 60664-1
Nominal voltage (III/3)	320 V
Rated surge voltage (III/3)	4 kV
Rated voltage (III/2)	320 V
Rated surge voltage (III/2)	4 kV
Nominal voltage (II/2)	630 V
Rated surge voltage (II/2)	4 kV
Rated current	12 A

Supus modificărilor.

WAGO Kontakttechnik GmbH & Co. KG  
 /Representative Office Romania  
 Sos. Pipera-Tunari nr. 1/1  
 building 1, 2nd floor | 077190 Voluntari, Ilfov  
 Tel.: +40-(0)31 421 85 68 | Email: info-RO@wago.com

Aveți întrebări despre produsele noastre?  
 Vă stăm la dispoziție pentru preluarea apelului la +40 (0) 31 421 85 68.



Legend (ratings)

(III / 2) ≙ Overvoltage category III / Pollution degree 2

**Approvals per UL 1059**

Rated voltage UL (Use Group B)	300 V
Rated current UL (Use Group B)	10 A
Rated voltage UL (Use Group D)	300 V
Rated current UL (Use Group D)	10 A
Approvals per	UL 1059

**Approvals per UL 1977**

Rated voltage UL 1977	600 V
Rated current UL 1977	10 A

**Approvals per CSA**

Rated voltage CSA (Use Group B)	300 V
Rated current CSA (Use Group B)	10 A
Rated voltage CSA (Use Group D)	300 V
Rated current CSA (Use Group D)	10 A

**Connection data**

Pole No.	22
Total number of potentials	22
Number of connection types	1
Number of levels	1

**Geometrical Data**

Pin spacing	5 mm / 0.197 inch
Width	113.2 mm / 4.457 inch
Height	17 mm / 0.669 inch
Height from the surface	12 mm / 0.472 inch
Depth	8.4 mm / 0.331 inch
Solder pin length	5 mm
Solder pin dimensions	1 x 1 mm
Drilled hole diameter with tolerance	1.4 <sup>(+0.1)</sup> mm

Supus modificărilor.

WAGO Kontakttechnik GmbH & Co. KG  
 /Representative Office Romania  
 Sos. Pipera-Tunari nr. 1/1  
 building 1, 2nd floor | 077190 Voluntari, Ilfov  
 Tel.: +40-(0)31 421 85 68 | Email: info-RO@wago.com

Aveți întrebări despre produsele noastre?  
 Vă stăm la dispoziție pentru preluarea apelului la +40 (0) 31 421 85 68.



## Plug connection

Contact type (pluggable connector)	Male connector/plug
Connector (connection type)	for PCBs
Mismating protection	No
Mating direction to the PCB	90°

## PCB contact

PCB contact	THT
Solder pin arrangement	over the entire male connector, in line
Number of solder pins per potential	1

## Material Data

Color	gray
Material group	I
Insulation material	Polyamide 66 (PA 66)
Flammability class per UL94	V0
Contact material	Electrolytic copper (E <sub>Cu</sub> )
Contact plating	tin-plated
Fire load	0,119 MJ
Weight	6,8 g

## Environmental Requirements

Limit temperature range	-60 ... +100 °C
-------------------------	-----------------

## Commercial data

Product Group	3 (Multi Conn. System)
Packaging type	BOX
Country of origin	PL
GTIN	4044918864275
Customs tariff number	85366990990

## Aprobări / certificate

### Country specific Approvals

Emblemă	Aprobare	Text de aprobare suplimentar	Nume certificat
---------	----------	------------------------------	-----------------

Supus modificărilor.

WAGO Kontakttechnik GmbH & Co. KG  
 /Representative Office Romania  
 Sos. Pipera-Tunari nr. 1/1  
 building 1, 2nd floor | 077190 Voluntari, Ilfov  
 Tel.: +40-(0)31 421 85 68 | Email: info-RO@wago.com

Aveți întrebări despre produsele noastre?  
 Vă stăm la dispoziție pentru preluarea apelului la +40 (0) 31 421 85 68.





CSA  
DEKRA Certification B.V.



C22.2

1466354





## Ship Approvals

Emblemă	Aprobare	Text de aprobare suplimentar	Nume certificat
	<b>ABS</b> American Bureau of Shipping	-	19- HG1869876- PDA
	<b>DNV GL</b> Det Norske Veritas, Germanischer Lloyd	-	TAE000016Z

## UL-Approvals

Emblemă	Aprobare	Text de aprobare suplimentar	Nume certificat
	<b>UL</b> Underwriters Laboratories Inc.	UL 1059	20190731- E45172
	<b>UR</b> UL International Germany GmbH	UL 1977	E45171

## Counterpart

	<b>Nr. articol</b> 231-122/026-000 1-conductor female plug; 2.5 mm <sup>2</sup> ; Pin spacing 5 mm; 22-pole; 2,50 mm <sup>2</sup> ; gray	<a href="http://www.wago.com/231-122/026-000">www.wago.com/231-122/026-000</a>
	<b>Nr. articol</b> 2231-122/031-000 1-conductor female plug; push-button; clamping collar; 2.5 mm <sup>2</sup> ; Pin spacing 5 mm; 22-pole; 2,50 mm <sup>2</sup> ; gray	<a href="http://www.wago.com/2231-122/031-000">www.wago.com/2231-122/031-000</a>
	<b>Nr. articol</b> 2231-122/026-000 1-conductor female plug; push-button; 2.5 mm <sup>2</sup> ; Pin spacing 5 mm; 22-pole; 2,50 mm <sup>2</sup> ; gray	<a href="http://www.wago.com/2231-122/026-000">www.wago.com/2231-122/026-000</a>
	<b>Nr. articol</b> 2231-122/102-000 1-conductor female plug; push-button; with integrated end plate; 2.5 mm <sup>2</sup> ; Pin spacing 5 mm; 22-pole; 2,50 mm <sup>2</sup> ; gray	<a href="http://www.wago.com/2231-122/102-000">www.wago.com/2231-122/102-000</a>
	<b>Nr. articol</b> 2231-122/037-000	

Supus modificărilor.

WAGO Kontakttechnik GmbH & Co. KG  
/Representative Office Romania  
Sos. Pipera-Tunari nr. 1/1  
building 1, 2nd floor | 077190 Voluntari, Ilfov  
Tel.: +40-(0)31 421 85 68 | Email: info-RO@wago.com

Aveți întrebări despre produsele noastre?  
Vă stăm la dispoziție pentru preluarea apelului la +40 (0) 31 421 85 68.

1-conductor female plug; push-button; Locking lever; 2.5 mm<sup>2</sup>; Pin spacing 5 mm; 22-pole; 2,50 mm<sup>2</sup>; gray [www.wago.com/2231-122/037-000](http://www.wago.com/2231-122/037-000)



**Nr. articol**231-122/027-000

1-conductor female plug; clamping collar; 2.5 mm<sup>2</sup>; Pin spacing 5 mm; 22-pole; 2,50 mm<sup>2</sup>; gray

[www.wago.com/231-122/027-000](http://www.wago.com/231-122/027-000)



**Nr. articol**231-122/031-000

1-conductor female plug; clamping collar; 2.5 mm<sup>2</sup>; Pin spacing 5 mm; 22-pole; 2,50 mm<sup>2</sup>; gray

[www.wago.com/231-122/031-000](http://www.wago.com/231-122/031-000)



**Nr. articol**231-122/026-000/035-000

1-conductor female plug; Strain relief plate; 2.5 mm<sup>2</sup>; Pin spacing 5 mm; 22-pole; 2,50 mm<sup>2</sup>; gray

[www.wago.com/231-122/026-000](http://www.wago.com/231-122/026-000)

/035-000



**Nr. articol**231-122/037-000

1-conductor female plug; Locking lever; 2.5 mm<sup>2</sup>; Pin spacing 5 mm; 22-pole; 2,50 mm<sup>2</sup>; gray

[www.wago.com/231-122/037-000](http://www.wago.com/231-122/037-000)



**Nr. articol**232-122/026-000

1-conductor female plug; angled; 2.5 mm<sup>2</sup>; Pin spacing 5 mm; 22-pole; 2,50 mm<sup>2</sup>; gray

[www.wago.com/232-122/026-000](http://www.wago.com/232-122/026-000)



**Nr. articol**231-122/102-000

1-conductor female plug; with integrated end plate; 2.5 mm<sup>2</sup>; Pin spacing 5 mm; 22-pole; 2,50 mm<sup>2</sup>; gray

[www.wago.com/231-122/102-000](http://www.wago.com/231-122/102-000)



**Nr. articol**232-222/026-000

1-conductor female plug; angled; 2.5 mm<sup>2</sup>; Pin spacing 5 mm; 22-pole; 2,50 mm<sup>2</sup>; gray

[www.wago.com/232-222/026-000](http://www.wago.com/232-222/026-000)

## Produse compatibile

### Marking accessories



**Nr. articol:** 210-833

Marking strips; on reel; 6 mm wide; plain; Self-adhesive; white

[www.wago.com/210-833](http://www.wago.com/210-833)



**Nr. articol:** 210-834

Marking strips; on reel; 5 mm wide; plain; Self-adhesive; white

[www.wago.com/210-834](http://www.wago.com/210-834)

### Coding



**Nr. articol:** 231-129

Coding key; snap-on type; light gray

[www.wago.com/231-129](http://www.wago.com/231-129)



**Nr. articol:** 231-500

Spacer; for formation of groups; light gray

[www.wago.com/231-500](http://www.wago.com/231-500)

Supus modificărilor.

**Descărcări****Documentation****Additional Information**

Technical explanations

Apr 3, 2019

pdf  
3,6 MB

Descărcare

**CAD/CAE-Data****CAD data**

2D/3D Models 231-152/001-000

URL

Descărcare

**CAE data**

EPLAN Data Portal 231-152/001-000

URL

Descărcare

**PCB Design**

Symbol and Footprint 231-152/001-000

URL

Descărcare

CAX data for your PCB design, consisting of "schematic symbols and PCB footprints", allow easy integration of the WAGO component into your development environment.

**Supported formats:**

- Accel EDA 14 & 15
- Altium 6 to current version
- Cadence Allegro
- DesignSpark
- Eagle Libraries
- KiCad
- Mentor Graphics BoardStation
- Mentor Graphics Design Architect
- Mentor Graphics Design Expedition 99 and 2000
- OrCAD 9.X PCB and Capture
- PADS PowerPCB 3, 3.5, 4.X, and 5.X
- PADS PowerPCB and PowerLogic 3.0
- PCAD 2000, 2001, 2002, 2004, and 2006
- Pulsonix 8.5 or newer
- STL
- 3D STEP

—  
Supus modificărilor.

WAGO Kontakttechnik GmbH & Co. KG  
/Representative Office Romania  
Sos. Pipera-Tunari nr. 1/1  
building 1, 2nd floor | 077190 Voluntari, Ilfov  
Tel.: +40-(0)31 421 85 68 | Email: info-RO@wago.com

Aveți întrebări despre produsele noastre?

Vă stăm la dispoziție pentru preluarea apelului la +40 (0) 31 421 85 68.

- TARGET 3001!
- View Logic ViewDraw
- Quadcept
- Zuken CadStar 3 and 4
- Zuken CR-5000 and CR-8000

PCB Component Libraries (EDA), PCB CAD Library Ultra Librarian

---

## Installation Notes

### Coding

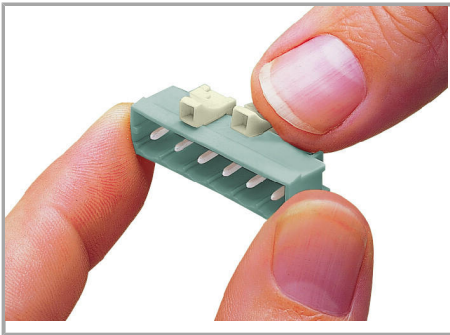

Coding a male header – fitting coding key(s).

## Familie de produse

<i>MCS</i> MIDI Classic

[Afișare globală produse din familie.](#)

Supus modificărilor.