

Fișă tehnică | Număr articol: 2002-2647

Double-deck terminal block; Ground conductor/through terminal block; PE /N; without marker carrier; for DIN-rail 35 x 15 and 35 x 7.5; 2.5 mm²; Push-in CAGE CLAMP®; 2,50 mm²; gray

www.wago.com/2002-2647

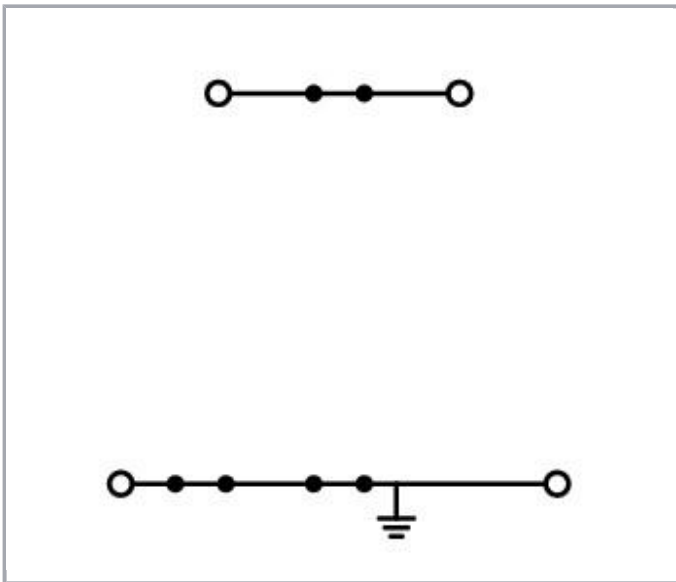
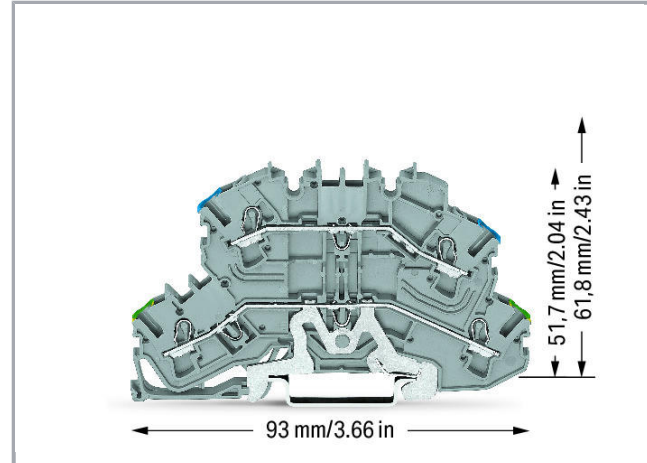
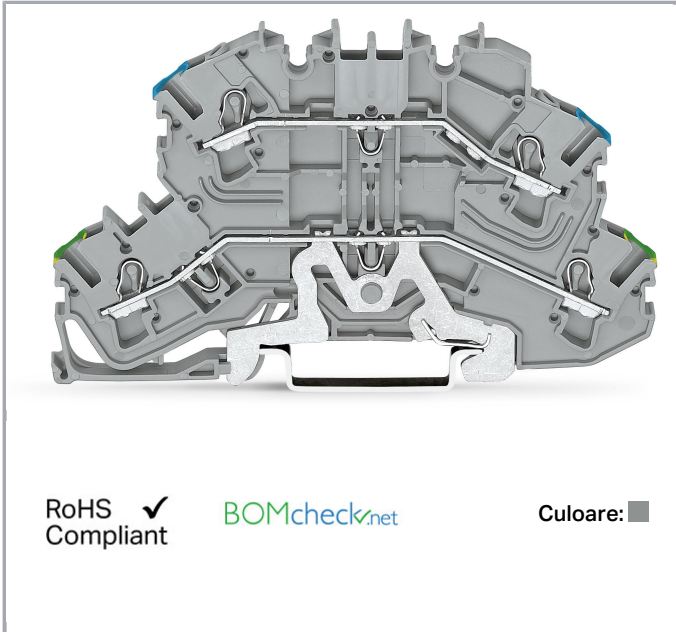

Date

Electrical data

Supus modificărilor.

WAGO Kontakttechnik GmbH & Co. KG
/Representative Office Romania
Sos. Pipera-Tunari nr. 1/1
building 1, 2nd floor | 077190 Voluntari, Ilfov
Tel.: +40-(0)31 421 85 68 | Email: info-RO@wago.com

Aveți întrebări despre produsele noastre?
Vă stăm la dispoziție pentru preluarea apelului la +40 (0) 31 421 85 68.



Ratings per IEC/EN 60664-1

Ratings per	IEC/EN 60947-7-1
Nominal voltage (III/3)	500 V
Rated surge voltage (III/3)	6 kV
Rated current	24 A
Legend (ratings)	(III / 3) ≙ Overvoltage category III / Pollution degree 3

Approvals per CSA

Rated voltage CSA (Use Group B)	600 V
Rated current CSA (Use Group B)	6,3 A
Rated voltage CSA (Use Group C)	600 V
Rated current CSA (Use Group C)	6,3 A

Connection data

Connection technology	Push-in CAGE CLAMP®
Actuation type	Push-in Open Tool Slot
Connectable conductor materials	Copper
Nominal cross-section	2,5 mm ²
Solid conductor	0,25 ... 4 mm ² / 22 ... 12 AWG
Solid conductor; push-in termination	0,75 ... 4 mm ² / 18 ... 12 AWG
Fine-stranded conductor	0,25 ... 4 mm ² / 22 ... 12 AWG
Fine-stranded conductor; with insulated ferrule	1 ... 2,5 mm ² / 18 ... 12 AWG
Fine-stranded conductor; with ferrule; push-in termination	1 ... 2,5 mm ² / 18 ... 12 AWG
Strip length	10 ... 12 mm / 0.39 ... 0.47 inch
Total number of connection points	4
Total number of potentials	2
Number of levels	2
Wiring type	Front-entry wiring
Note (conductor cross-section)	Depending on the conductor characteristic, a conductor with a smaller cross-section can also be inserted via push-in termination.

Geometrical Data

Width	5,2 mm / 0.205 inch
Height from upper-edge of DIN-rail	51,7 mm / 2.035 inch
Depth	93 mm / 3.661 inch

Supus modificărilor.

WAGO Kontakttechnik GmbH & Co. KG
/Representative Office Romania
Sos. Pipera-Tunari nr. 1/1
building 1, 2nd floor | 077190 Voluntari, Ilfov
Tel.: +40-(0)31 421 85 68 | Email: info-RO@wago.com

Aveți întrebări despre produsele noastre?
Vă stăm la dispoziție pentru preluarea apelului la +40 (0) 31 421 85 68.

Mechanical data

Design	horizontal type
Mounting type	DIN-35 rail
Potential marking	PE/N
Marking level	Center/side marking

Material Data



Color	gray
Insulation material	Polyamide 66 (PA 66)
Fire load	0,255 MJ
Weight	16,7 g

Commercial data

Product Group	22 (TOPJOB S)
Packaging type	BOX
Country of origin	DE
GTIN	4050821403852
Customs tariff number	85369010000

Aprobări / certificate

Country specific Approvals

Emblemă	Aprobare	Text de aprobare suplimentar	Nume certificat
	CCA DEKRA Certification B.V.	EN 60947	NTR NL 7730
	CSA DEKRA Certification B.V.	C22.2 No. 158	1536069
	KEMA/KEUR DEKRA Certification B.V.	EN 60947	71- 107687

Ship Approvals

Emblemă	Aprobare	Text de aprobare suplimentar	Nume certificat
---------	----------	------------------------------	-----------------

Supus modificărilor.



ABS
American Bureau of Shipping

EN 60947

20-
HG1941090-
PDA



DNV GL
Det Norske Veritas, Germanischer Lloyd

-

TAE00001V2





UL-Approvals

Emblemă	Aprobare	Text de aprobare suplimentar	Nume certificat
	UR Underwriters Laboratories Inc.	UL 1059	E45172

Counterpart

Produse compatibile















Jumper

	Nr. articol: 2002-400 Adjacent jumper for continuous commoning; insulated; 2-way; Nominal current 25 A; light gray	www.wago.com/2002-400
	Nr. articol: 2002-402 Push-in type jumper bar; insulated; 2-way; Nominal current 25 A; light gray	www.wago.com/2002-402
	Nr. articol: 2002-402/000-005 Push-in type jumper bar; insulated; 2-way; Nominal current 25 A; red	www.wago.com/2002-402/000-005
	Nr. articol: 2002-402/000-006 Push-in type jumper bar; insulated; 2-way; Nominal current 25 A; blue	www.wago.com/2002-402/000-006















Supus modificărilor.

WAGO Kontakttechnik GmbH & Co. KG
/Representative Office Romania
Sos. Pipera-Tunari nr. 1/1
building 1, 2nd floor | 077190 Voluntari, Ilfov
Tel.: +40-(0)31 421 85 68 | Email: info-RO@wago.com

Aveți întrebări despre produsele noastre?
Vă stăm la dispoziție pentru preluarea apelului la +40 (0) 31 421 85 68.

	Nr. articol: 2002-403 Push-in type jumper bar; insulated; 3-way; Nominal current 25 A; light gray	www.wago.com/2002-403
	Nr. articol: 2002-403/000-005 Push-in type jumper bar; insulated; 3-way; Nominal current 25 A; red	www.wago.com/2002-403/000-005
	Nr. articol: 2002-403/000-006 Push-in type jumper bar; insulated; 3-way; Nominal current 25 A; blue	www.wago.com/2002-403/000-006
	Nr. articol: 2002-404 Push-in type jumper bar; insulated; 4-way; Nominal current 25 A; light gray	www.wago.com/2002-404
	Nr. articol: 2002-404/000-005 Push-in type jumper bar; insulated; 4-way; Nominal current 25 A; red	www.wago.com/2002-404/000-005
	Nr. articol: 2002-404/000-006 Push-in type jumper bar; insulated; 4-way; Nominal current 25 A; blue	www.wago.com/2002-404/000-006
	Nr. articol: 2002-405 Push-in type jumper bar; insulated; 5-way; Nominal current 25 A; light gray	www.wago.com/2002-405
	Nr. articol: 2002-405/000-005 Push-in type jumper bar; insulated; 5-way; Nominal current 25 A; red	www.wago.com/2002-405/000-005
	Nr. articol: 2002-405/000-006 Push-in type jumper bar; insulated; 5-way; Nominal current 25 A; blue	www.wago.com/2002-405/000-006
	Nr. articol: 2002-405/011-000 Star point jumper; insulated; 3-way (1-3-5); IN = IN terminal block; light gray	www.wago.com/2002-405/011-000
	Nr. articol: 2002-406 Push-in type jumper bar; insulated; 6-way; Nominal current 25 A; light gray	www.wago.com/2002-406
	Nr. articol: 2002-406/000-005 Push-in type jumper bar; insulated; 6-way; Nominal current 25 A; red	www.wago.com/2002-406/000-005
	Nr. articol: 2002-406/000-006 Push-in type jumper bar; insulated; 6-way; Nominal current 25 A; blue	www.wago.com/2002-406/000-006
	Nr. articol: 2002-406/020-000 Delta jumper; insulated; 1-2 3-4 5-6; IN = IN terminal block; light gray	www.wago.com/2002-406/020-000

Supus modificărilor.

	Nr. articol: 2002-407 Push-in type jumper bar; insulated; 7-way; Nominal current 25 A; light gray	www.wago.com/2002-407
	Nr. articol: 2002-407/000-005 Push-in type jumper bar; insulated; 7-way; Nominal current 25 A; red	www.wago.com/2002-407/000-005
	Nr. articol: 2002-407/000-006 Push-in type jumper bar; insulated; 7-way; Nominal current 25 A; blue	www.wago.com/2002-407/000-006
	Nr. articol: 2002-408 Push-in type jumper bar; insulated; 8-way; Nominal current 25 A; light gray	www.wago.com/2002-408
	Nr. articol: 2002-408/000-005 Push-in type jumper bar; insulated; 8-way; Nominal current 25 A; red	www.wago.com/2002-408/000-005
	Nr. articol: 2002-408/000-006 Push-in type jumper bar; insulated; 8-way; Nominal current 25 A; blue	www.wago.com/2002-408/000-006
	Nr. articol: 2002-409 Push-in type jumper bar; insulated; 9-way; Nominal current 25 A; light gray	www.wago.com/2002-409
	Nr. articol: 2002-409/000-005 Push-in type jumper bar; insulated; 9-way; Nominal current 25 A; red	www.wago.com/2002-409/000-005
	Nr. articol: 2002-409/000-006 Push-in type jumper bar; insulated; 9-way; Nominal current 25 A; blue	www.wago.com/2002-409/000-006
	Nr. articol: 2002-410 Push-in type jumper bar; insulated; 10-way; Nominal current 25 A; light gray	www.wago.com/2002-410
	Nr. articol: 2002-410/000-005 Push-in type jumper bar; insulated; 10-way; Nominal current 25 A; red	www.wago.com/2002-410/000-005
	Nr. articol: 2002-410/000-006 Push-in type jumper bar; insulated; 10-way; Nominal current 25 A; blue	www.wago.com/2002-410/000-006
	Nr. articol: 2002-423 Adjacent jumper for continuous commoning; insulated; from 1 to 3; Nominal current 25 A; light gray	www.wago.com/2002-423
	Nr. articol: 2002-423/000-005 Adjacent jumper for continuous commoning; insulated; from 1 to 3; Nominal current 25 A; red	www.wago.com/2002-423/000-005
	Nr. articol: 2002-423/000-006 Adjacent jumper for continuous commoning; insulated; from 1 to 3; Nominal current 25 A; blue	www.wago.com/2002-423/000-006

Supus modificărilor.

	Nr. articol: 2002-433 Push-in type jumper bar; insulated; from 1 to 3; Nominal current 25 A; light gray	www.wago.com/2002-433
	Nr. articol: 2002-434 Push-in type jumper bar; insulated; from 1 to 4; Nominal current 25 A; light gray	www.wago.com/2002-434
	Nr. articol: 2002-435 Push-in type jumper bar; insulated; from 1 to 5; Nominal current 25 A; light gray	www.wago.com/2002-435
	Nr. articol: 2002-436 Push-in type jumper bar; insulated; from 1 to 6; Nominal current 25 A; light gray	www.wago.com/2002-436
	Nr. articol: 2002-437 Push-in type jumper bar; insulated; from 1 to 7; Nominal current 25 A; light gray	www.wago.com/2002-437
	Nr. articol: 2002-438 Push-in type jumper bar; insulated; from 1 to 8; Nominal current 25 A; light gray	www.wago.com/2002-438
	Nr. articol: 2002-439 Push-in type jumper bar; insulated; from 1 to 9; Nominal current 25 A; light gray	www.wago.com/2002-439
	Nr. articol: 2002-440 Push-in type jumper bar; insulated; from 1 to 10; Nominal current 25 A; light gray	www.wago.com/2002-440
	Nr. articol: 2002-472 Staggered jumper; insulated; 2-way; Nominal current 25 A; suitable for 2002 and 2003 Series rail-mounted terminal blocks; light gray	www.wago.com/2002-472
	Nr. articol: 2002-473 Staggered jumper; insulated; 3-way; Nominal current 25 A; suitable for 2002 and 2003 Series rail-mounted terminal blocks; light gray	www.wago.com/2002-473
	Nr. articol: 2002-473/011-000 Ready-made staggered jumper; insulated; 2-way (1-3); Nominal current 25 A; with contact lugs broken off at the factory and circuit marking; light gray	www.wago.com/2002-473/011-000
	Nr. articol: 2002-474 Staggered jumper; insulated; 4-way; Nominal current 25 A; suitable for 2002 and 2003 Series rail-mounted terminal blocks; light gray	www.wago.com/2002-474
	Nr. articol: 2002-475 Staggered jumper; insulated; 5-way; Nominal current 25 A; suitable for 2002 and 2003 Series rail-mounted terminal blocks; light gray	www.wago.com/2002-475
	Nr. articol: 2002-475/011-000 Ready-made staggered jumper; insulated; 3-way (1-3-5); Nominal current 25 A; with contact lugs broken off at the factory and circuit marking; light gray	www.wago.com/2002-475/011-000
	Nr. articol: 2002-476 Staggered jumper; insulated; 6-way; Nominal current 25 A; suitable for 2002 and 2003 Series rail-mounted terminal blocks; light gray	www.wago.com/2002-476
	Nr. articol: 2002-477 Staggered jumper; insulated; 7-way; Nominal current 25 A; suitable for 2002 and 2003 Series rail-mounted terminal blocks; light gray	www.wago.com/2002-477
	Nr. articol: 2002-477/011-000	

Supus modificărilor.



Ready-made staggered jumper; insulated; 1-3-5-7; Nominal current 25 A; with contact lugs broken off at the factory and circuit marking; light gray

www.wago.com/2002-477/011-000



Nr. articol: 2002-478

Staggered jumper; insulated; 8-way; Nominal current 25 A; suitable for 2002 and 2003 Series rail-mounted terminal blocks; light gray

www.wago.com/2002-478



Nr. articol: 2002-479

Staggered jumper; insulated; 9-way; Nominal current 25 A; suitable for 2002 and 2003 Series rail-mounted terminal blocks; light gray

www.wago.com/2002-479

Nr. articol: 2002-479/011-000

Ready-made staggered jumper; insulated; 1-3-5-7-9; Nominal current 25 A; with contact lugs broken off at the factory and circuit marking; light gray

www.wago.com/2002-479/011-000



Nr. articol: 2002-480

Staggered jumper; insulated; 10-way; Nominal current 25 A; suitable for 2002 and 2003 Series rail-mounted terminal blocks; light gray

www.wago.com/2002-480



Nr. articol: 2002-481

Staggered jumper; insulated; 11-way; Nominal current 25 A; suitable for 2002 and 2003 Series rail-mounted terminal blocks; light gray

www.wago.com/2002-481

Nr. articol: 2002-481/011-000

Ready-made staggered jumper; insulated; 1-3-5-7-9-11; Nominal current 25 A; with contact lugs broken off at the factory and circuit marking; light gray

www.wago.com/2002-481/011-000



Nr. articol: 2002-482

Staggered jumper; insulated; 12-way; Nominal current 25 A; suitable for 2002 and 2003 Series rail-mounted terminal blocks; light gray

www.wago.com/2002-482



Nr. articol: 2002-492

Double-deck vertical jumper; insulated; light gray

www.wago.com/2002-492



Nr. articol: 2002-492/000-012

Double-deck vertical jumper; insulated; orange

www.wago.com/2002-492/000-012



Nr. articol: 210-103

Wire commoning chain; insulated; 50 connections; black

www.wago.com/210-103

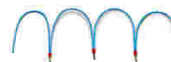

Nr. articol: 210-123

Wire commoning chain; insulated; 50 connections

www.wago.com/210-123

check



Nr. articol: 2002-611

TOPJOB®S L-type test plug module; modular; 1-pole; 2,50 mm²; gray

www.wago.com/2002-611



Nr. articol: 2002-649

TOPJOB®S L-type spacer module; modular; e.g., for bridging commoned terminal blocks; gray

www.wago.com/2002-649



Nr. articol: 2009-174

Test plug adapter; for 4 mm Ø test plugs; for testing TOPJOB®S rail-mounted terminal blocks; gray

www.wago.com/2009-174



Nr. articol: 2009-182

Testing tap; for max. 2.5 mm²; tool-free connection for individual test wires 0.08 - 2.5 mm; gray









www.wago.com/2009-182

Supus modificărilor.





End plate

	Nr. articol: 2002-2691 End and intermediate plate; 1 mm thick; gray	www.wago.com/2002-2691
	Nr. articol: 2002-2692 End and intermediate plate; 1 mm thick; orange	www.wago.com/2002-2692













ferrule

	Nr. articol: 216-241 Ferrule; Sleeve for 0.5 mm ² / 20 AWG; insulated; electro-tin plated; electrolytic copper; gastight crimped; acc. to DIN 46228, Part 4/09.90; white	www.wago.com/216-241
	Nr. articol: 216-242 Ferrule; Sleeve for 0.75 mm ² / 18 AWG; insulated; electro-tin plated; electrolytic copper; gastight crimped; acc. to DIN 46228, Part 4/09.90; gray	www.wago.com/216-242
	Nr. articol: 216-243 Ferrule; Sleeve for 1 mm ² / AWG 18; insulated; electro-tin plated; electrolytic copper; gastight crimped; acc. to DIN 46228, Part 4/09.90; red	www.wago.com/216-243
	Nr. articol: 216-244 Ferrule; Sleeve for 1.5 mm ² / AWG 16; insulated; electro-tin plated; electrolytic copper; gastight crimped; acc. to DIN 46228, Part 4/09.90; black	www.wago.com/216-244
	Nr. articol: 216-246 Ferrule; Sleeve for 2.5 mm ² / AWG 14; insulated; electro-tin plated; electrolytic copper; gastight crimped; acc. to DIN 46228, Part 4/09.90; blue	www.wago.com/216-246
	Nr. articol: 216-262 Ferrule; Sleeve for 0.75 mm ² / 18 AWG; insulated; electro-tin plated; electrolytic copper; gastight crimped; acc. to DIN 46228, Part 4/09.90; gray	www.wago.com/216-262
	Nr. articol: 216-263 Ferrule; Sleeve for 1 mm ² / AWG 18; insulated; electro-tin plated; electrolytic copper; gastight crimped; acc. to DIN 46228, Part 4/09.90; red	www.wago.com/216-263
	Nr. articol: 216-264 Ferrule; Sleeve for 1.5 mm ² / AWG 16; insulated; electro-tin plated; electrolytic copper; gastight crimped; acc. to DIN 46228, Part 4/09.90; black	www.wago.com/216-264
	Nr. articol: 216-266 Ferrule; Sleeve for 2.5 mm ² / AWG 14; insulated; electro-tin plated; electrolytic copper; gastight crimped; acc. to DIN 46228, Part 4/09.90; blue	www.wago.com/216-266















Marking accessories

	Nr. articol: 2002-121 Adaptor	www.wago.com/2002-121
	Nr. articol: 2002-161 Adaptor	www.wago.com/2002-161
	Nr. articol: 2009-110 Marking strips; on reel; not stretchable; plain; snap-on type; white	www.wago.com/2009-110
	Nr. articol: 2009-115 WMB-Inline; for Smart Printer; 1500 pieces on roll; stretchable 5 - 5.2 mm; plain; snap-on type; white	www.wago.com/2009-115

Supus modificărilor.

	Nr. articol: 2009-115/000-002 WMB-Inline; for Smart Printer; 1500 pieces on roll; stretchable 5 - 5.2 mm; plain; snap-on type; yellow	www.wago.com/2009-115/000-002
	Nr. articol: 2009-115/000-005 WMB-Inline; for Smart Printer; 1500 pieces on roll; stretchable 5 - 5.2 mm; plain; snap-on type; red	www.wago.com/2009-115/000-005
	Nr. articol: 2009-115/000-006 WMB-Inline; for Smart Printer; 1500 pieces on roll; stretchable 5 - 5.2 mm; plain; snap-on type; blue	www.wago.com/2009-115/000-006
	Nr. articol: 2009-115/000-007 WMB-Inline; for Smart Printer; 1500 pieces on roll; stretchable 5 - 5.2 mm; plain; snap-on type; gray	www.wago.com/2009-115/000-007
	Nr. articol: 2009-115/000-012 WMB-Inline; for Smart Printer; 1500 pieces on roll; stretchable 5 - 5.2 mm; plain; snap-on type; orange	www.wago.com/2009-115/000-012
	Nr. articol: 2009-115/000-017 WMB-Inline; for Smart Printer; 1500 pieces on roll; stretchable 5 - 5.2 mm; plain; snap-on type; light green	www.wago.com/2009-115/000-017
	Nr. articol: 2009-115/000-023 WMB-Inline; for Smart Printer; 1500 pieces on roll; stretchable 5 - 5.2 mm; plain; snap-on type; green	www.wago.com/2009-115/000-023
	Nr. articol: 2009-115/000-024 WMB-Inline; for Smart Printer; 1500 pieces on roll; stretchable 5 - 5.2 mm; plain; snap-on type; violet	www.wago.com/2009-115/000-024
	Nr. articol: 2009-145 Mini-WSB Inline; for Smart Printer; 1700 pieces on roll; stretchable 5 - 5.2 mm; plain; snap-on type; white	www.wago.com/2009-145
	Nr. articol: 2009-145/000-002 Mini-WSB Inline; for Smart Printer; 1700 pieces on roll; stretchable 5 - 5.2 mm; plain; snap-on type; yellow	www.wago.com/2009-145/000-002
	Nr. articol: 2009-145/000-005 Mini-WSB Inline; for Smart Printer; 1700 pieces on roll; stretchable 5 - 5.2 mm; plain; snap-on type; red	www.wago.com/2009-145/000-005
	Nr. articol: 2009-145/000-006 Mini-WSB Inline; for Smart Printer; 1700 pieces on roll; stretchable 5 - 5.2 mm; plain; snap-on type; blue	www.wago.com/2009-145/000-006
	Nr. articol: 2009-145/000-007 Mini-WSB Inline; for Smart Printer; 1700 pieces on roll; stretchable 5 - 5.2 mm; plain; snap-on type; gray	www.wago.com/2009-145/000-007
	Nr. articol: 2009-145/000-012	

Supus modificărilor.

	Mini-WSB Inline; for Smart Printer; 1700 pieces on roll; stretchable 5 - 5.2 mm; plain; snap-on type; orange	www.wago.com/2009-145/000-012
	Nr. articol: 2009-145/000-023 Mini-WSB Inline; for Smart Printer; 1700 pieces on roll; stretchable 5 - 5.2 mm; plain; snap-on type; green	www.wago.com/2009-145/000-023
	Nr. articol: 2009-145/000-024 Mini-WSB Inline; for Smart Printer; 1700 pieces on roll; stretchable 5 - 5.2 mm; plain; snap-on type; violet	www.wago.com/2009-145/000-024
	Nr. articol: 2009-191 Group marker carrier	www.wago.com/2009-191
	Nr. articol: 2009-192 Group marker carrier	www.wago.com/2009-192
	Nr. articol: 2009-193 Group marker carrier	www.wago.com/2009-193
	Nr. articol: 2009-198 Adaptor	www.wago.com/2009-198
	Nr. articol: 248-501 Miniature WSB Quick marking system; plain; Marker width 5 mm; 10 strips with 10 markers per card	www.wago.com/248-501
	Nr. articol: 248-501/000-002 Mini-WSB marking card; as card; not stretchable; plain; snap-on type; yellow	www.wago.com/248-501/000-002
	Nr. articol: 248-501/000-005 Mini-WSB marking card; as card; not stretchable; plain; snap-on type; red	www.wago.com/248-501/000-005
	Nr. articol: 248-501/000-006 Mini-WSB marking card; as card; not stretchable; plain; snap-on type; blue	www.wago.com/248-501/000-006
	Nr. articol: 248-501/000-007 Mini-WSB marking card; as card; not stretchable; plain; snap-on type; gray	www.wago.com/248-501/000-007
	Nr. articol: 248-501/000-012 Mini-WSB marking card; as card; not stretchable; plain; snap-on type; orange	www.wago.com/248-501/000-012
	Nr. articol: 248-501/000-017 Mini-WSB marking card; as card; not stretchable; plain; snap-on type; light green	www.wago.com/248-501/000-017
	Nr. articol: 248-501/000-023 Mini-WSB marking card; as card; not stretchable; plain; snap-on type; green	www.wago.com/248-501/000-023

Supus modificărilor.

WAGO Kontakttechnik GmbH & Co. KG
 /Representative Office Romania
 Sos. Pipera-Tunari nr. 1/1
 building 1, 2nd floor | 077190 Voluntari, Ilfov
 Tel.: +40-(0)31 421 85 68 | Email: info-RO@wago.com

Aveți întrebări despre produsele noastre?
 Vă stăm la dispoziție pentru preluarea apelului la +40 (0) 31 421 85 68.

**Nr. articol:** 248-501/000-024

Mini-WSB marking card; as card; not stretchable; plain; snap-on type; violet

www.wago.com/248-501/000-024**Nr. articol:** 793-501

WMB marking card; as card; not stretchable; plain; snap-on type; white

www.wago.com/793-501**Nr. articol:** 793-501/000-002

WMB marking card; as card; not stretchable; plain; snap-on type; yellow

www.wago.com/793-501/000-002**Nr. articol:** 793-501/000-005

WMB marking card; as card; not stretchable; plain; snap-on type; red

www.wago.com/793-501/000-005**Nr. articol:** 793-501/000-006

WMB marking card; as card; not stretchable; plain; snap-on type; blue

www.wago.com/793-501/000-006**Nr. articol:** 793-501/000-007

WMB marking card; as card; not stretchable; plain; snap-on type; gray

www.wago.com/793-501/000-007**Nr. articol:** 793-501/000-012

WMB marking card; as card; not stretchable; plain; snap-on type; orange

www.wago.com/793-501/000-012**Nr. articol:** 793-501/000-017

WMB marking card; as card; not stretchable; plain; snap-on type; light green

www.wago.com/793-501/000-017**Nr. articol:** 793-501/000-023

WMB marking card; as card; not stretchable; plain; snap-on type; green

www.wago.com/793-501/000-023**Nr. articol:** 793-501/000-024

WMB marking card; as card; not stretchable; plain; snap-on type; violet

www.wago.com/793-501/000-024**Nr. articol:** 793-5501

WMB marking card; as card; for terminal block width 5 - 17.5 mm; stretchable 5 - 5.2 mm; plain; snap-on type; white

www.wago.com/793-5501**Nr. articol:** 793-5501/000-002

WMB marking card; as card; for terminal block width 5 - 17.5 mm; stretchable 5 - 5.2 mm; plain; snap-on type; yellow

www.wago.com/793-5501/000-002**Nr. articol:** 793-5501/000-005

WMB marking card; as card; for terminal block width 5 - 17.5 mm; stretchable 5 - 5.2 mm; plain; snap-on type; red

www.wago.com/793-5501/000-005**Nr. articol:** 793-5501/000-006

Supus modificărilor.



WMB marking card; as card; for terminal block width 5 - 17.5 mm; stretchable 5 - 5.2 mm; plain; snap-on type; blue

www.wago.com/793-5501/000-006



Nr. articol: 793-5501/000-007

WMB marking card; as card; for terminal block width 5 - 17.5 mm; stretchable 5 - 5.2 mm; plain; snap-on type; gray

www.wago.com/793-5501/000-007



Nr. articol: 793-5501/000-012

WMB marking card; as card; for terminal block width 5 - 17.5 mm; stretchable 5 - 5.2 mm; plain; snap-on type; orange

www.wago.com/793-5501/000-012



Nr. articol: 793-5501/000-014

WMB marking card; as card; for terminal block width 5 - 17.5 mm; stretchable 5 - 5.2 mm; plain; snap-on type; brown

www.wago.com/793-5501/000-014



Nr. articol: 793-5501/000-017

WMB marking card; as card; for terminal block width 5 - 17.5 mm; stretchable 5 - 5.2 mm; plain; snap-on type; green

www.wago.com/793-5501/000-017



Nr. articol: 793-5501/000-023

WMB marking card; as card; for terminal block width 5 - 17.5 mm; stretchable 5 - 5.2 mm; plain; snap-on type; light green

www.wago.com/793-5501/000-023



Nr. articol: 793-5501/000-024

WMB marking card; as card; for terminal block width 5 - 17.5 mm; stretchable 5 - 5.2 mm; plain; snap-on type; violet

www.wago.com/793-5501/000-024

Insulation stop



Nr. articol: 2002-171

Insulation stop; 0.25 - 0.5 mm²; 5 pieces/strip; light gray

www.wago.com/2002-171



Nr. articol: 2002-172

Insulation stop; 0.75 - 1 mm²; 5 pieces/strip; dark gray

www.wago.com/2002-172

Push-In type wire jumper



Nr. articol: 2009-412

Push-in type wire jumper; insulated; wire length 60 mm; Conductor cross section 1.5 mm²; suitable for 2001, 2002, 2003 and 2022 Series rail-mounted terminal blocks; black

www.wago.com/2009-412



Nr. articol: 2009-414

Push-in type wire jumper; insulated; wire length 110 mm; Conductor cross section 1.5 mm²; suitable for 2001, 2002, 2003 and 2022 Series rail-mounted terminal blocks; black

www.wago.com/2009-414



Nr. articol: 2009-414/000-005

Push-in type wire jumper; insulated; wire length 110 mm; Conductor cross section 1.5 mm²; suitable for 2001, 2002, 2003 and 2022 Series rail-mounted terminal blocks; red

www.wago.com/2009-414/000-005



Nr. articol: 2009-414/000-006

Push-in type wire jumper; insulated; wire length 110 mm; Conductor cross section 1.5 mm²; suitable for 2001, 2002, 2003 and 2022 Series rail-mounted terminal blocks; blue

www.wago.com/2009-414/000-006

Nr. articol: 2009-416

Push-in type wire jumper; insulated; wire length 250 mm; Conductor cross section 1.5 mm²; suitable

www.wago.com/2009-416

Supus modificărilor.



for 2001, 2002, 2003 and 2022 Series rail-mounted terminal blocks; black

Protective Warning Marker

**Nr. articol: 2002-115**

Protective warning marker; with high-voltage symbol, black; for 5 terminal blocks; yellow

www.wago.com/2002-115

Carrier rail

**Nr. articol: 210-112**

Steel carrier rail; 35 x 7.5 mm; 1 mm thick; 2 m long; slotted; according to EN 60715; "Hole width 25 mm

www.wago.com/210-112**Nr. articol: 210-113**

Steel carrier rail; 35 x 7.5 mm; 1 mm thick; 2 m long; unslotted; according to EN 60715

www.wago.com/210-113**Nr. articol: 210-114**

Steel carrier rail; 35 x 15 mm; 1.5 mm thick; 2 m long; unslotted; similar to EN 60715

www.wago.com/210-114**Nr. articol: 210-115**

Steel carrier rail; 35 x 7.5 mm; 1 mm thick; 2 m long; slotted; according to EN 60715; "Hole width 18 mm

www.wago.com/210-115**Nr. articol: 210-118**

Steel carrier rail; 35 x 15 mm; 2.3 mm thick; 2 m long; unslotted; according to EN 60715

www.wago.com/210-118**Nr. articol: 210-196**

Aluminum carrier rail; 35 x 8.2 mm; 1.6 mm thick; 2 m long; unslotted; similar to EN 60715; silver-colored

www.wago.com/210-196**Nr. articol: 210-197**

Steel carrier rail; 35 x 15 mm; 1.5 mm thick; 2 m long; slotted; similar to EN 60715

www.wago.com/210-197**Nr. articol: 210-198**

Copper carrier rail; 35 x 15 mm; 2.3 mm thick; 2 m long; unslotted; according to EN 60715; copper-colored

www.wago.com/210-198**Nr. articol: 210-504**

Steel carrier rail; 35 x 7.5 mm; 1 mm thick; 2 m long; slotted; galvanized; according to EN 60715

www.wago.com/210-504**Nr. articol: 210-505**

Steel carrier rail; 35 x 7.5 mm; 1 mm thick; 2 m long; unslotted; galvanized; according to EN 60715

www.wago.com/210-505**Nr. articol: 210-506**

Steel carrier rail; 35 x 15 mm; 1.5 mm thick; 2 m long; unslotted; galvanized; similar to EN 60715

www.wago.com/210-506**Nr. articol: 210-508**

Steel carrier rail; 35 x 15 mm; 1.5 mm thick; 2 m long; slotted; galvanized; similar to EN 60715

www.wago.com/210-508

tools

**Nr. articol: 210-658**

Operating tool; Blade: 3.5 x 0.5 mm; with a partially insulated shaft; angled; short

www.wago.com/210-658**Nr. articol: 210-720**

Operating tool; Blade: 3.5 x 0.5 mm; with a partially insulated shaft

www.wago.com/210-720

Supus modificărilor.

Descărcări Documentation

Additional Information

Technical explanations

Apr 3, 2019

pdf
2,1 MB

Descărcare

CAD/CAE-Data

CAD data

2D/3D Models 2002-2647

URL

Descărcare

CAE data

EPLAN Data Portal 2002-2647

URL

Descărcare

WSCAD Universe 2002-2647

URL

Descărcare

Installation Notes

Conductor termination

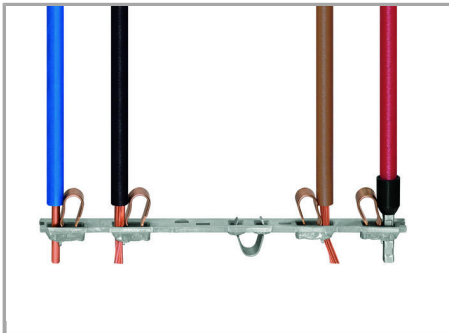

All conductor types at a glance

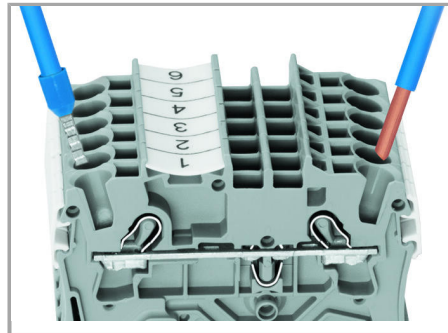

Terminating solid and ferruled conductors via push-in connection.

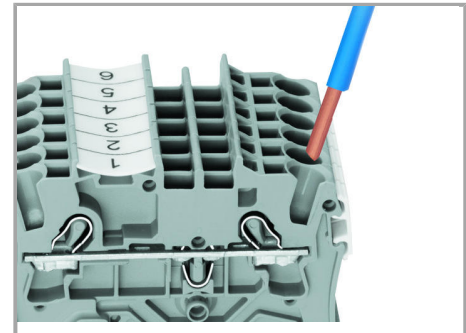

Inserting conductors via push-in termination.

Solid conductors with cross-sections from either one size above, or up to two sizes below, the rated cross-section can be simply pushed in – no tools needed.

Supus modificărilor.

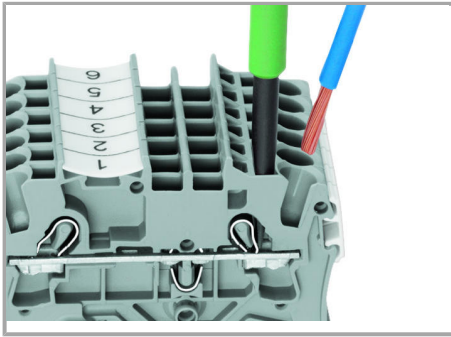

Inserting a conductor via operating tool.

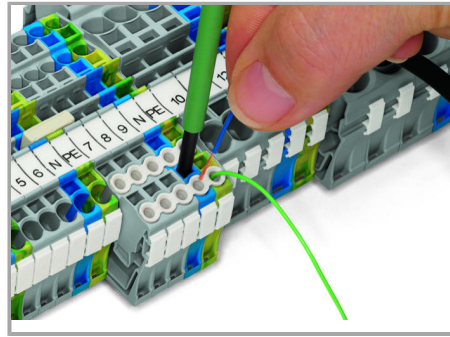

Conductor termination – Insulation stop.

Connecting fine-stranded conductors without ferrules, or small cross-sectional conductors that cannot be pushed in, is performed similarly to the original CAGE CLAMP® – just use an operating tool.

The smart feature:

To open the clamp, the operating tool is inserted vertically. The conductor entry is less than 15 degrees for easier wiring.

Commoning

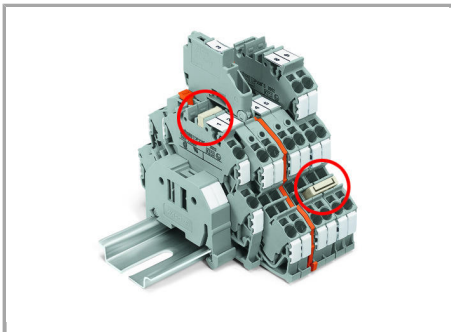

The same profile allows for commoning with TOPJOB® S double-deck terminal blocks (upper deck) and with triple-deck terminal blocks (lower deck).

Supus modificărilor.

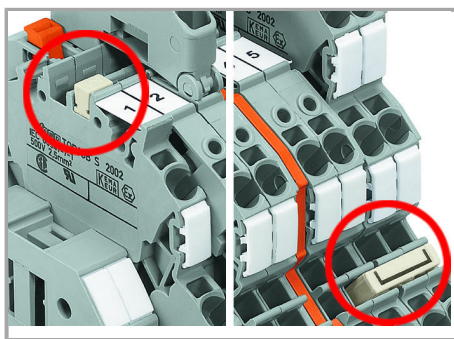

Left picture – Vertical jumper (2002-492)

Right picture – Push-in type jumper bar
(2002 Series)

Familie de produse

TOPJOB® S

TOPJOB® S: In various industrial applications and modern building installations, WAGO's wide and versatile range of rail-mount terminal blocks provides more than just reliable electrical connections.

[Afișare globală produse din familie.](#)

Supus modificărilor.