

## Fișă tehnică | Număr articol: 2022-1307/999-953

2-conductor/1-pin ground carrier terminal block; suitable for Ex nA applications; for DIN-rail 35 x 15 and 35 x 7.5; 2.5 mm<sup>2</sup>; Push-in CAGE CLAMP®; 2,50 mm<sup>2</sup>; green-yellow

[www.wago.com/2022-1307/999-953](http://www.wago.com/2022-1307/999-953)

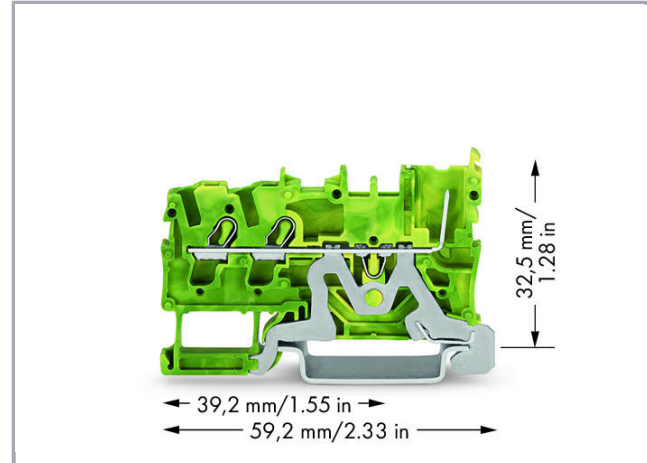
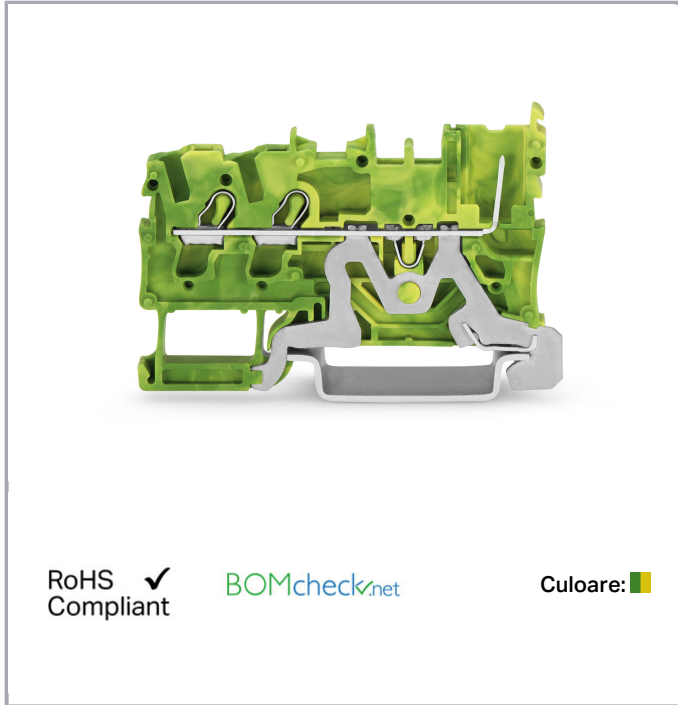

RoHS Compliant

[BOMcheck.net](https://www.bomcheck.net)

Culoare:

### Date

#### Electrical data

#### Ratings per IEC/EN 60664-1

Ratings per

IEC/EN 60947-7-2

#### Connection data

Connection technology	Push-in CAGE CLAMP®
Number of connection points (connection type)	2
Actuation type	Open Tool Slot Push-in
Connectable conductor materials	Copper
Nominal cross-section	2.5 mm <sup>2</sup>
Solid conductor	0,25 ... 4 mm <sup>2</sup> / 22 ... 12 AWG
Solid conductor; push-in termination	0.75 ... 4 mm <sup>2</sup> / 18 ... 12 AWG

Supus modificărilor.

WAGO Kontakttechnik GmbH & Co. KG  
/Representative Office Romania  
Sos. Pipera-Tunari nr. 1/1  
building 1, 2nd floor | 077190 Voluntari, Ilfov  
Tel.: +40-(0)31 421 85 68 | Email: info-RO@wago.com

Aveți întrebări despre produsele noastre?  
Vă stăm la dispoziție pentru preluarea apelului la +40 (0) 31 421 85 68.



Fine-stranded conductor	0,25 ... 4 mm <sup>2</sup> / 22 ... 12 AWG
Fine-stranded conductor; with insulated ferrule	1 ... 2.5 mm <sup>2</sup> / 18 ... 12 AWG
Fine-stranded conductor; with ferrule; push-in termination	1 ... 2.5 mm <sup>2</sup> / 18 ... 12 AWG
Strip length	10 ... 12 mm / 0.39 ... 0.47 inch
Number of connection points	1
Total number of connection points	2
Total number of potentials	1
Number of levels	1
Wiring type	Front-entry wiring
Note (conductor cross-section)	Depending on the conductor characteristic, a conductor with a smaller cross section can also be inserted via push-in termination.

### Geometrical Data

Width	5.2 mm / 0.205 inch
Height from upper-edge of DIN-rail	32.5 mm / 1.28 inch
Depth	59.2 mm / 2.331 inch

### Mechanical data

Design	horizontal
Mounting type	DIN-35 rail
Marking level	Center/side marking

### Material Data

Color	green-yellow
Insulation material	Polyamide 66 (PA 66)
Fire load	0,136 MJ
Weight	9,4 g

### Commercial data

Packaging type	BOX
Country of origin	CN
GTIN	4050821644781
Customs tariff number	85366990990

### Aprobări / certificate

#### Ex-Approvals

Nume



Supus modificărilor.

WAGO Kontakttechnik GmbH & Co. KG  
 /Representative Office Romania  
 Sos. Pipera-Tunari nr. 1/1  
 building 1, 2nd floor | 077190 Voluntari, Ilfov  
 Tel.: +40-(0)31 421 85 68 | Email: info-RO@wago.com

Aveți întrebări despre produsele noastre?  
 Vă stăm la dispoziție pentru preluarea apelului la +40 (0) 31 421 85 68.

Emblemă	Aprobare	Text de aprobare suplimentar	certificat
	ATEX Physikalisch Technische Bundesanstalt (PTB)	EN 60079	PTB 13 ATEX 1004 U (II 3 G Ex nA IIC Gc)

## Country specific Approvals

Emblemă	Aprobare	Text de aprobare suplimentar	Nume certificat
	CCA DEKRA Certification B.V.	EN 60947	NTR NL 7628
	CSA DEKRA Certification B.V.	C22.2 No. 158	2437422
	KEMA/KEUR DEKRA Certification B.V.	EN 61984	71- 101201

## UL-Approvals

Emblemă	Aprobare	Text de aprobare suplimentar	Nume certificat
	UR Underwriters Laboratories Inc.	UL 1059	E45172

## Counterpart













## Produse compatibile

Supus modificărilor.















WAGO Kontakttechnik GmbH & Co. KG  
/Representative Office Romania  
Sos. Pipera-Tunari nr. 1/1  
building 1, 2nd floor | 077190 Voluntari, Ilfov  
Tel.: +40-(0)31 421 85 68 | Email: info-RO@wago.com

Aveți întrebări despre produsele noastre?  
Vă stăm la dispoziție pentru preluarea apelului la +40 (0) 31 421 85 68.















## Jumper

	<b>Nr. articol: 2002-400</b> Adjacent jumper for continuous commoning; insulated; 2-way; Nominal current 25 A; light gray	<a href="http://www.wago.com/2002-400">www.wago.com/2002-400</a>
	<b>Nr. articol: 2002-402</b> Push-in type jumper bar; insulated; 2-way; Nominal current 25 A; light gray	<a href="http://www.wago.com/2002-402">www.wago.com/2002-402</a>
	<b>Nr. articol: 2002-402/000-005</b> Push-in type jumper bar; insulated; 2-way; Nominal current 25 A; red	<a href="http://www.wago.com/2002-402/000-005">www.wago.com/2002-402/000-005</a>
	<b>Nr. articol: 2002-402/000-006</b> Push-in type jumper bar; insulated; 2-way; Nominal current 25 A; blue	<a href="http://www.wago.com/2002-402/000-006">www.wago.com/2002-402/000-006</a>
	<b>Nr. articol: 2002-403</b> Push-in type jumper bar; insulated; 3-way; Nominal current 25 A; light gray	<a href="http://www.wago.com/2002-403">www.wago.com/2002-403</a>
	<b>Nr. articol: 2002-403/000-005</b> Push-in type jumper bar; insulated; 3-way; Nominal current 25 A; red	<a href="http://www.wago.com/2002-403/000-005">www.wago.com/2002-403/000-005</a>
	<b>Nr. articol: 2002-403/000-006</b> Push-in type jumper bar; insulated; 3-way; Nominal current 25 A; blue	<a href="http://www.wago.com/2002-403/000-006">www.wago.com/2002-403/000-006</a>
	<b>Nr. articol: 2002-404</b> Push-in type jumper bar; insulated; 4-way; Nominal current 25 A; light gray	<a href="http://www.wago.com/2002-404">www.wago.com/2002-404</a>
	<b>Nr. articol: 2002-404/000-005</b> Push-in type jumper bar; insulated; 4-way; Nominal current 25 A; red	<a href="http://www.wago.com/2002-404/000-005">www.wago.com/2002-404/000-005</a>
	<b>Nr. articol: 2002-404/000-006</b> Push-in type jumper bar; insulated; 4-way; Nominal current 25 A; blue	<a href="http://www.wago.com/2002-404/000-006">www.wago.com/2002-404/000-006</a>
	<b>Nr. articol: 2002-405</b> Push-in type jumper bar; insulated; 5-way; Nominal current 25 A; light gray	<a href="http://www.wago.com/2002-405">www.wago.com/2002-405</a>
	<b>Nr. articol: 2002-405/000-005</b> Push-in type jumper bar; insulated; 5-way; Nominal current 25 A; red	<a href="http://www.wago.com/2002-405/000-005">www.wago.com/2002-405/000-005</a>
	<b>Nr. articol: 2002-405/000-006</b> Push-in type jumper bar; insulated; 5-way; Nominal current 25 A; blue	<a href="http://www.wago.com/2002-405/000-006">www.wago.com/2002-405/000-006</a>

Supus modificărilor.

	<b>Nr. articol:</b> 2002-405/011-000 Star point jumper; insulated; 3-way (1-3-5); IN = IN terminal block; light gray	<a href="http://www.wago.com/2002-405/011-000">www.wago.com/2002-405/011-000</a>
	<b>Nr. articol:</b> 2002-406 Push-in type jumper bar; insulated; 6-way; Nominal current 25 A; light gray	<a href="http://www.wago.com/2002-406">www.wago.com/2002-406</a>
	<b>Nr. articol:</b> 2002-406/000-005 Push-in type jumper bar; insulated; 6-way; Nominal current 25 A; red	<a href="http://www.wago.com/2002-406/000-005">www.wago.com/2002-406/000-005</a>
	<b>Nr. articol:</b> 2002-406/000-006 Push-in type jumper bar; insulated; 6-way; Nominal current 25 A; blue	<a href="http://www.wago.com/2002-406/000-006">www.wago.com/2002-406/000-006</a>
	<b>Nr. articol:</b> 2002-406/020-000 Delta jumper; insulated; 1-2 3-4 5-6; IN = IN terminal block; light gray	<a href="http://www.wago.com/2002-406/020-000">www.wago.com/2002-406/020-000</a>
	<b>Nr. articol:</b> 2002-407 Push-in type jumper bar; insulated; 7-way; Nominal current 25 A; light gray	<a href="http://www.wago.com/2002-407">www.wago.com/2002-407</a>
	<b>Nr. articol:</b> 2002-407/000-005 Push-in type jumper bar; insulated; 7-way; Nominal current 25 A; red	<a href="http://www.wago.com/2002-407/000-005">www.wago.com/2002-407/000-005</a>
	<b>Nr. articol:</b> 2002-407/000-006 Push-in type jumper bar; insulated; 7-way; Nominal current 25 A; blue	<a href="http://www.wago.com/2002-407/000-006">www.wago.com/2002-407/000-006</a>
	<b>Nr. articol:</b> 2002-408 Push-in type jumper bar; insulated; 8-way; Nominal current 25 A; light gray	<a href="http://www.wago.com/2002-408">www.wago.com/2002-408</a>
	<b>Nr. articol:</b> 2002-408/000-005 Push-in type jumper bar; insulated; 8-way; Nominal current 25 A; red	<a href="http://www.wago.com/2002-408/000-005">www.wago.com/2002-408/000-005</a>
	<b>Nr. articol:</b> 2002-408/000-006 Push-in type jumper bar; insulated; 8-way; Nominal current 25 A; blue	<a href="http://www.wago.com/2002-408/000-006">www.wago.com/2002-408/000-006</a>
	<b>Nr. articol:</b> 2002-409 Push-in type jumper bar; insulated; 9-way; Nominal current 25 A; light gray	<a href="http://www.wago.com/2002-409">www.wago.com/2002-409</a>
	<b>Nr. articol:</b> 2002-409/000-005 Push-in type jumper bar; insulated; 9-way; Nominal current 25 A; red	<a href="http://www.wago.com/2002-409/000-005">www.wago.com/2002-409/000-005</a>
	<b>Nr. articol:</b> 2002-409/000-006 Push-in type jumper bar; insulated; 9-way; Nominal current 25 A; blue	<a href="http://www.wago.com/2002-409/000-006">www.wago.com/2002-409/000-006</a>
	<b>Nr. articol:</b> 2002-410 Push-in type jumper bar; insulated; 10-way; Nominal current 25 A; light gray	<a href="http://www.wago.com/2002-410">www.wago.com/2002-410</a>













Supus modificărilor.

	<b>Nr. articol:</b> 2002-410/000-005 Push-in type jumper bar; insulated; 10-way; Nominal current 25 A; red	<a href="http://www.wago.com/2002-410/000-005">www.wago.com/2002-410/000-005</a>
	<b>Nr. articol:</b> 2002-410/000-006 Push-in type jumper bar; insulated; 10-way; Nominal current 25 A; blue	<a href="http://www.wago.com/2002-410/000-006">www.wago.com/2002-410/000-006</a>
	<b>Nr. articol:</b> 2002-423 Adjacent jumper for continuous commoning; insulated; from 1 to 3; Nominal current 25 A; light gray	<a href="http://www.wago.com/2002-423">www.wago.com/2002-423</a>
	<b>Nr. articol:</b> 2002-423/000-005 Adjacent jumper for continuous commoning; insulated; from 1 to 3; Nominal current 25 A; red	<a href="http://www.wago.com/2002-423/000-005">www.wago.com/2002-423/000-005</a>
	<b>Nr. articol:</b> 2002-423/000-006 Adjacent jumper for continuous commoning; insulated; from 1 to 3; Nominal current 25 A; blue	<a href="http://www.wago.com/2002-423/000-006">www.wago.com/2002-423/000-006</a>
	<b>Nr. articol:</b> 2002-433 Push-in type jumper bar; insulated; from 1 to 3; Nominal current 25 A; light gray	<a href="http://www.wago.com/2002-433">www.wago.com/2002-433</a>
	<b>Nr. articol:</b> 2002-434 Push-in type jumper bar; insulated; from 1 to 4; Nominal current 25 A; light gray	<a href="http://www.wago.com/2002-434">www.wago.com/2002-434</a>
	<b>Nr. articol:</b> 2002-435 Push-in type jumper bar; insulated; from 1 to 5; Nominal current 25 A; light gray	<a href="http://www.wago.com/2002-435">www.wago.com/2002-435</a>
	<b>Nr. articol:</b> 2002-436 Push-in type jumper bar; insulated; from 1 to 6; Nominal current 25 A; light gray	<a href="http://www.wago.com/2002-436">www.wago.com/2002-436</a>
	<b>Nr. articol:</b> 2002-437 Push-in type jumper bar; insulated; from 1 to 7; Nominal current 25 A; light gray	<a href="http://www.wago.com/2002-437">www.wago.com/2002-437</a>
	<b>Nr. articol:</b> 2002-438 Push-in type jumper bar; insulated; from 1 to 8; Nominal current 25 A; light gray	<a href="http://www.wago.com/2002-438">www.wago.com/2002-438</a>
	<b>Nr. articol:</b> 2002-439 Push-in type jumper bar; insulated; from 1 to 9; Nominal current 25 A; light gray	<a href="http://www.wago.com/2002-439">www.wago.com/2002-439</a>
	<b>Nr. articol:</b> 2002-440 Push-in type jumper bar; insulated; from 1 to 10; Nominal current 25 A; light gray	<a href="http://www.wago.com/2002-440">www.wago.com/2002-440</a>
	<b>Nr. articol:</b> 2002-472 Staggered jumper; insulated; 2-way; Nominal current 25 A; suitable for 2002 and 2003 Series rail-mounted terminal blocks; light gray	<a href="http://www.wago.com/2002-472">www.wago.com/2002-472</a>
	<b>Nr. articol:</b> 2002-473 Staggered jumper; insulated; 3-way; Nominal current 25 A; suitable for 2002 and 2003 Series rail-mounted terminal blocks; light gray	<a href="http://www.wago.com/2002-473">www.wago.com/2002-473</a>
	<b>Nr. articol:</b> 2002-473/011-000 Ready-made staggered jumper; insulated; 2-way (1-3); Nominal current 25 A; with contact lugs broken off at the factory and circuit marking; light gray	<a href="http://www.wago.com/2002-473/011-000">www.wago.com/2002-473/011-000</a>

Supus modificărilor.















WAGO Kontakttechnik GmbH & Co. KG  
/Representative Office Romania  
Sos. Pipera-Tunari nr. 1/1  
building 1, 2nd floor | 077190 Voluntari, Ilfov  
Tel.: +40-(0)31 421 85 68 | Email: info-RO@wago.com

Aveți întrebări despre produsele noastre?  
Vă stăm la dispoziție pentru preluarea apelului la +40 (0) 31 421 85 68.

	<b>Nr. articol: 2002-474</b> Staggered jumper; insulated; 4-way; Nominal current 25 A; suitable for 2002 and 2003 Series rail-mounted terminal blocks; light gray	<a href="http://www.wago.com/2002-474">www.wago.com/2002-474</a>
	<b>Nr. articol: 2002-475</b> Staggered jumper; insulated; 5-way; Nominal current 25 A; suitable for 2002 and 2003 Series rail-mounted terminal blocks; light gray	<a href="http://www.wago.com/2002-475">www.wago.com/2002-475</a>
	<b>Nr. articol: 2002-475/011-000</b> Ready-made staggered jumper; insulated; 3-way (1-3-5); Nominal current 25 A; with contact lugs broken off at the factory and circuit marking; light gray	<a href="http://www.wago.com/2002-475/011-000">www.wago.com/2002-475/011-000</a>
	<b>Nr. articol: 2002-476</b> Staggered jumper; insulated; 6-way; Nominal current 25 A; suitable for 2002 and 2003 Series rail-mounted terminal blocks; light gray	<a href="http://www.wago.com/2002-476">www.wago.com/2002-476</a>
	<b>Nr. articol: 2002-477</b> Staggered jumper; insulated; 7-way; Nominal current 25 A; suitable for 2002 and 2003 Series rail-mounted terminal blocks; light gray	<a href="http://www.wago.com/2002-477">www.wago.com/2002-477</a>
	<b>Nr. articol: 2002-477/011-000</b> Ready-made staggered jumper; insulated; 1-3-5-7; Nominal current 25 A; with contact lugs broken off at the factory and circuit marking; light gray	<a href="http://www.wago.com/2002-477/011-000">www.wago.com/2002-477/011-000</a>
	<b>Nr. articol: 2002-478</b> Staggered jumper; insulated; 8-way; Nominal current 25 A; suitable for 2002 and 2003 Series rail-mounted terminal blocks; light gray	<a href="http://www.wago.com/2002-478">www.wago.com/2002-478</a>
	<b>Nr. articol: 2002-479</b> Staggered jumper; insulated; 9-way; Nominal current 25 A; suitable for 2002 and 2003 Series rail-mounted terminal blocks; light gray	<a href="http://www.wago.com/2002-479">www.wago.com/2002-479</a>
	<b>Nr. articol: 2002-479/011-000</b> Ready-made staggered jumper; insulated; 1-3-5-7-9; Nominal current 25 A; with contact lugs broken off at the factory and circuit marking; light gray	<a href="http://www.wago.com/2002-479/011-000">www.wago.com/2002-479/011-000</a>
	<b>Nr. articol: 2002-480</b> Staggered jumper; insulated; 10-way; Nominal current 25 A; suitable for 2002 and 2003 Series rail-mounted terminal blocks; light gray	<a href="http://www.wago.com/2002-480">www.wago.com/2002-480</a>
	<b>Nr. articol: 2002-481</b> Staggered jumper; insulated; 11-way; Nominal current 25 A; suitable for 2002 and 2003 Series rail-mounted terminal blocks; light gray	<a href="http://www.wago.com/2002-481">www.wago.com/2002-481</a>
	<b>Nr. articol: 2002-481/011-000</b> Ready-made staggered jumper; insulated; 1-3-5-7-9-11; Nominal current 25 A; with contact lugs broken off at the factory and circuit marking; light gray	<a href="http://www.wago.com/2002-481/011-000">www.wago.com/2002-481/011-000</a>
	<b>Nr. articol: 2002-482</b> Staggered jumper; insulated; 12-way; Nominal current 25 A; suitable for 2002 and 2003 Series rail-mounted terminal blocks; light gray	<a href="http://www.wago.com/2002-482">www.wago.com/2002-482</a>
	<b>Nr. articol: 210-103</b> Wire commoning chain; insulated; 50 connections; black	<a href="http://www.wago.com/210-103">www.wago.com/210-103</a>
	<b>Nr. articol: 210-123</b> Wire commoning chain; insulated; 50 connections	<a href="http://www.wago.com/210-123">www.wago.com/210-123</a>

**Carrier rail**

Supus modificărilor.

















	<b>Nr. articol: 210-112</b> Steel carrier rail; 35 x 7.5 mm; 1 mm thick; 2 m long; slotted; according to EN 60715; "Hole width 25 mm	<a href="http://www.wago.com/210-112">www.wago.com/210-112</a>
	<b>Nr. articol: 210-113</b> Steel carrier rail; 35 x 7.5 mm; 1 mm thick; 2 m long; unslotted; according to EN 60715	<a href="http://www.wago.com/210-113">www.wago.com/210-113</a>
	<b>Nr. articol: 210-114</b> Steel carrier rail; 35 x 15 mm; 1.5 mm thick; 2 m long; unslotted; similar to EN 60715	<a href="http://www.wago.com/210-114">www.wago.com/210-114</a>
	<b>Nr. articol: 210-115</b> Steel carrier rail; 35 x 7.5 mm; 1 mm thick; 2 m long; slotted; according to EN 60715; "Hole width 18 mm	<a href="http://www.wago.com/210-115">www.wago.com/210-115</a>
	<b>Nr. articol: 210-118</b> Steel carrier rail; 35 x 15 mm; 2.3 mm thick; 2 m long; unslotted; according to EN 60715	<a href="http://www.wago.com/210-118">www.wago.com/210-118</a>
	<b>Nr. articol: 210-196</b> Aluminum carrier rail; 35 x 8.2 mm; 1.6 mm thick; 2 m long; unslotted; similar to EN 60715; silver-colored	<a href="http://www.wago.com/210-196">www.wago.com/210-196</a>
	<b>Nr. articol: 210-197</b> Steel carrier rail; 35 x 15 mm; 1.5 mm thick; 2 m long; slotted; similar to EN 60715	<a href="http://www.wago.com/210-197">www.wago.com/210-197</a>
	<b>Nr. articol: 210-198</b> Copper carrier rail; 35 x 15 mm; 2.3 mm thick; 2 m long; unslotted; according to EN 60715; copper-colored	<a href="http://www.wago.com/210-198">www.wago.com/210-198</a>
<b>Protective Warning Marker</b>		
	<b>Nr. articol: 2002-115</b> Protective warning marker; with high-voltage symbol, black; for 5 terminal blocks; yellow	<a href="http://www.wago.com/2002-115">www.wago.com/2002-115</a>
<b>ferrule</b>		
	<b>Nr. articol: 216-241</b> Ferrule; Sleeve for 0.5 mm <sup>2</sup> / 20 AWG; insulated; electro-tin plated; electrolytic copper; gastight crimped; acc. to DIN 46228, Part 4/09.90; white	<a href="http://www.wago.com/216-241">www.wago.com/216-241</a>
	<b>Nr. articol: 216-242</b> Ferrule; Sleeve for 0.75 mm <sup>2</sup> / 18 AWG; insulated; electro-tin plated; electrolytic copper; gastight crimped; acc. to DIN 46228, Part 4/09.90; gray	<a href="http://www.wago.com/216-242">www.wago.com/216-242</a>
	<b>Nr. articol: 216-243</b> Ferrule; Sleeve for 1 mm <sup>2</sup> / AWG 18; insulated; electro-tin plated; electrolytic copper; gastight crimped; acc. to DIN 46228, Part 4/09.90; red	<a href="http://www.wago.com/216-243">www.wago.com/216-243</a>
	<b>Nr. articol: 216-244</b> Ferrule; Sleeve for 1.5 mm <sup>2</sup> / AWG 16; insulated; electro-tin plated; electrolytic copper; gastight crimped; acc. to DIN 46228, Part 4/09.90; black	<a href="http://www.wago.com/216-244">www.wago.com/216-244</a>
	<b>Nr. articol: 216-246</b> Ferrule; Sleeve for 2.5 mm <sup>2</sup> / AWG 14; insulated; electro-tin plated; electrolytic copper; gastight crimped; acc. to DIN 46228, Part 4/09.90; blue	<a href="http://www.wago.com/216-246">www.wago.com/216-246</a>
	<b>Nr. articol: 216-262</b> Ferrule; Sleeve for 0.75 mm <sup>2</sup> / 18 AWG; insulated; electro-tin plated; electrolytic copper; gastight crimped; acc. to DIN 46228, Part 4/09.90; gray	<a href="http://www.wago.com/216-262">www.wago.com/216-262</a>
	<b>Nr. articol: 216-263</b> Ferrule; Sleeve for 1 mm <sup>2</sup> / AWG 18; insulated; electro-tin plated; electrolytic copper; gastight	<a href="http://www.wago.com/216-263">www.wago.com/216-263</a>

Supus modificărilor.















WAGO Kontakttechnik GmbH & Co. KG  
/Representative Office Romania  
Sos. Pipera-Tunari nr. 1/1  
building 1, 2nd floor | 077190 Voluntari, Ilfov  
Tel.: +40-(0)31 421 85 68 | Email: info-RO@wago.com

Aveți întrebări despre produsele noastre?  
Vă stăm la dispoziție pentru preluarea apelului la +40 (0) 31 421 85 68.



	crimped; acc. to DIN 46228, Part 4/09.90; red	
	<b>Nr. articol: 216-264</b> Ferrule; Sleeve for 1.5 mm <sup>2</sup> / AWG 16; insulated; electro-tin plated; electrolytic copper; gastight crimped; acc. to DIN 46228, Part 4/09.90; black	<a href="http://www.wago.com/216-264">www.wago.com/216-264</a>
	<b>Nr. articol: 216-266</b> Ferrule; Sleeve for 2.5 mm <sup>2</sup> / AWG 14; insulated; electro-tin plated; electrolytic copper; gastight crimped; acc. to DIN 46228, Part 4/09.90; blue	<a href="http://www.wago.com/216-266">www.wago.com/216-266</a>
	<b>Nr. articol: 216-284</b> Ferrule; Sleeve for 1.5 mm <sup>2</sup> / AWG 16; insulated; electro-tin plated; electrolytic copper; gastight crimped; acc. to DIN 46228, Part 4/09.90; black	<a href="http://www.wago.com/216-284">www.wago.com/216-284</a>
	<b>Nr. articol: 216-286</b> Ferrule; Sleeve for 2.5 mm <sup>2</sup> / AWG 14; insulated; electro-tin plated; electrolytic copper; gastight crimped; acc. to DIN 46228, Part 4/09.90; blue	<a href="http://www.wago.com/216-286">www.wago.com/216-286</a>
<b>Insulation stop</b>		
	<b>Nr. articol: 2002-171</b> Insulation stop; 0.25 - 0.5 mm <sup>2</sup> ; 5 pieces/strip; light gray	<a href="http://www.wago.com/2002-171">www.wago.com/2002-171</a>
	<b>Nr. articol: 2002-172</b> Insulation stop; 0.75 - 1 mm <sup>2</sup> ; 5 pieces/strip; dark gray	<a href="http://www.wago.com/2002-172">www.wago.com/2002-172</a>
<b>check</b>		
	<b>Nr. articol: 2002-511</b> Modular TOPJOB®S connector; modular; for jumper contact slot; 1-pole; 2,50 mm <sup>2</sup> ; gray	<a href="http://www.wago.com/2002-511">www.wago.com/2002-511</a>
	<b>Nr. articol: 2002-549</b> Spacer module; modular; e.g., for bridging commoned terminal blocks; gray	<a href="http://www.wago.com/2002-549">www.wago.com/2002-549</a>
	<b>Nr. articol: 2002-552</b> Modular TOPJOB®S connector; modular; for jumper contact slot; 2-pole; 2,50 mm <sup>2</sup> ; gray	<a href="http://www.wago.com/2002-552">www.wago.com/2002-552</a>
	<b>Nr. articol: 2002-553</b> Modular TOPJOB®S connector; modular; for jumper contact slot; 3-pole; 2,50 mm <sup>2</sup> ; gray	<a href="http://www.wago.com/2002-553">www.wago.com/2002-553</a>
	<b>Nr. articol: 2002-554</b> Modular TOPJOB®S connector; modular; for jumper contact slot; 4-pole; 2,50 mm <sup>2</sup> ; gray	<a href="http://www.wago.com/2002-554">www.wago.com/2002-554</a>
	<b>Nr. articol: 2002-555</b> Modular TOPJOB®S connector; modular; for jumper contact slot; 5-pole; 2,50 mm <sup>2</sup> ; gray	<a href="http://www.wago.com/2002-555">www.wago.com/2002-555</a>
	<b>Nr. articol: 2002-556</b> Modular TOPJOB®S connector; modular; for jumper contact slot; 6-pole; 2,50 mm <sup>2</sup> ; gray	<a href="http://www.wago.com/2002-556">www.wago.com/2002-556</a>
	<b>Nr. articol: 2002-557</b> Modular TOPJOB®S connector; modular; for jumper contact slot; 7-pole; 2,50 mm <sup>2</sup> ; gray	<a href="http://www.wago.com/2002-557">www.wago.com/2002-557</a>
	<b>Nr. articol: 2002-558</b> Modular TOPJOB®S connector; modular; for jumper contact slot; 8-pole; 2,50 mm <sup>2</sup> ; gray	<a href="http://www.wago.com/2002-558">www.wago.com/2002-558</a>
	<b>Nr. articol: 2002-559</b> Modular TOPJOB®S connector; modular; for jumper contact slot; 9-pole; 2,50 mm <sup>2</sup> ; gray	<a href="http://www.wago.com/2002-559">www.wago.com/2002-559</a>















Supus modificărilor.

	<b>Nr. articol: 2002-560</b> Modular TOPJOB®S connector; modular; for jumper contact slot; 10-pole; 2,50 mm <sup>2</sup> ; gray	<a href="http://www.wago.com/2002-560">www.wago.com/2002-560</a>
	<b>Nr. articol: 2009-174</b> Test plug adapter; for 4 mm Ø test plugs; for testing TOPJOB®S rail-mounted terminal blocks; gray	<a href="http://www.wago.com/2009-174">www.wago.com/2009-174</a>
	<b>Nr. articol: 2009-182</b> Testing tap; for max. 2.5 mm <sup>2</sup> ; tool-free connection for individual test wires 0.08 - 2.5 mm; gray	<a href="http://www.wago.com/2009-182">www.wago.com/2009-182</a>
	<b>Nr. articol: 859-500</b> Test pin; 1 mm Ø; with solder connection for test wire	<a href="http://www.wago.com/859-500">www.wago.com/859-500</a>
<b>tools</b>		
	<b>Nr. articol: 210-720</b> Operating tool; Blade: 3.5 x 0.5 mm; with a partially insulated shaft	<a href="http://www.wago.com/210-720">www.wago.com/210-720</a>
<b>Marking accessories</b>		
	<b>Nr. articol: 2002-161</b> Adaptor	<a href="http://www.wago.com/2002-161">www.wago.com/2002-161</a>
	<b>Nr. articol: 2009-110</b> Marking strips; on reel; not stretchable; plain; snap-on type; white	<a href="http://www.wago.com/2009-110">www.wago.com/2009-110</a>
	<b>Nr. articol: 2009-115</b> WMB-Inline; for Smart Printer; 1500 pieces on roll; stretchable 5 - 5.2 mm; plain; snap-on type; white	<a href="http://www.wago.com/2009-115">www.wago.com/2009-115</a>
	<b>Nr. articol: 2009-115/000-002</b> WMB-Inline; for Smart Printer; 1500 pieces on roll; stretchable 5 - 5.2 mm; plain; snap-on type; yellow	<a href="http://www.wago.com/2009-115/000-002">www.wago.com/2009-115/000-002</a>
	<b>Nr. articol: 2009-115/000-005</b> WMB-Inline; for Smart Printer; 1500 pieces on roll; stretchable 5 - 5.2 mm; plain; snap-on type; red	<a href="http://www.wago.com/2009-115/000-005">www.wago.com/2009-115/000-005</a>
	<b>Nr. articol: 2009-115/000-006</b> WMB-Inline; for Smart Printer; 1500 pieces on roll; stretchable 5 - 5.2 mm; plain; snap-on type; blue	<a href="http://www.wago.com/2009-115/000-006">www.wago.com/2009-115/000-006</a>
	<b>Nr. articol: 2009-115/000-007</b> WMB-Inline; for Smart Printer; 1500 pieces on roll; stretchable 5 - 5.2 mm; plain; snap-on type; gray	<a href="http://www.wago.com/2009-115/000-007">www.wago.com/2009-115/000-007</a>
	<b>Nr. articol: 2009-115/000-012</b> WMB-Inline; for Smart Printer; 1500 pieces on roll; stretchable 5 - 5.2 mm; plain; snap-on type; orange	<a href="http://www.wago.com/2009-115/000-012">www.wago.com/2009-115/000-012</a>
	<b>Nr. articol: 2009-115/000-017</b> WMB-Inline; for Smart Printer; 1500 pieces on roll; stretchable 5 - 5.2 mm; plain; snap-on type; light green	<a href="http://www.wago.com/2009-115/000-017">www.wago.com/2009-115/000-017</a>
	<b>Nr. articol: 2009-115/000-023</b> WMB-Inline; for Smart Printer; 1500 pieces on roll; stretchable 5 - 5.2 mm; plain; snap-on type; green	<a href="http://www.wago.com/2009-115/000-023">www.wago.com/2009-115/000-023</a>













Supus modificărilor.

WAGO Kontakttechnik GmbH & Co. KG  
/Representative Office Romania  
Sos. Pipera-Tunari nr. 1/1  
building 1, 2nd floor | 077190 Voluntari, Ilfov  
Tel.: +40-(0)31 421 85 68 | Email: info-RO@wago.com

Aveți întrebări despre produsele noastre?  
Vă stăm la dispoziție pentru preluarea apelului la +40 (0) 31 421 85 68.

	<b>Nr. articol: 2009-115/000-024</b> WMB-Inline; for Smart Printer; 1500 pieces on roll; stretchable 5 - 5.2 mm; plain; snap-on type; violet	<a href="http://www.wago.com/2009-115/000-024">www.wago.com/2009-115/000-024</a>
	<b>Nr. articol: 2009-145</b> Mini-WSB Inline; for Smart Printer; 1700 pieces on roll; stretchable 5 - 5.2 mm; plain; snap-on type; white	<a href="http://www.wago.com/2009-145">www.wago.com/2009-145</a>
	<b>Nr. articol: 2009-145/000-002</b> Mini-WSB Inline; for Smart Printer; 1700 pieces on roll; stretchable 5 - 5.2 mm; plain; snap-on type; yellow	<a href="http://www.wago.com/2009-145/000-002">www.wago.com/2009-145/000-002</a>
	<b>Nr. articol: 2009-145/000-005</b> Mini-WSB Inline; for Smart Printer; 1700 pieces on roll; stretchable 5 - 5.2 mm; plain; snap-on type; red	<a href="http://www.wago.com/2009-145/000-005">www.wago.com/2009-145/000-005</a>
	<b>Nr. articol: 2009-145/000-006</b> Mini-WSB Inline; for Smart Printer; 1700 pieces on roll; stretchable 5 - 5.2 mm; plain; snap-on type; blue	<a href="http://www.wago.com/2009-145/000-006">www.wago.com/2009-145/000-006</a>
	<b>Nr. articol: 2009-145/000-007</b> Mini-WSB Inline; for Smart Printer; 1700 pieces on roll; stretchable 5 - 5.2 mm; plain; snap-on type; gray	<a href="http://www.wago.com/2009-145/000-007">www.wago.com/2009-145/000-007</a>
	<b>Nr. articol: 2009-145/000-012</b> Mini-WSB Inline; for Smart Printer; 1700 pieces on roll; stretchable 5 - 5.2 mm; plain; snap-on type; orange	<a href="http://www.wago.com/2009-145/000-012">www.wago.com/2009-145/000-012</a>
	<b>Nr. articol: 2009-145/000-023</b> Mini-WSB Inline; for Smart Printer; 1700 pieces on roll; stretchable 5 - 5.2 mm; plain; snap-on type; green	<a href="http://www.wago.com/2009-145/000-023">www.wago.com/2009-145/000-023</a>
	<b>Nr. articol: 2009-145/000-024</b> Mini-WSB Inline; for Smart Printer; 1700 pieces on roll; stretchable 5 - 5.2 mm; plain; snap-on type; violet	<a href="http://www.wago.com/2009-145/000-024">www.wago.com/2009-145/000-024</a>
	<b>Nr. articol: 2009-191</b> Group marker carrier	<a href="http://www.wago.com/2009-191">www.wago.com/2009-191</a>
	<b>Nr. articol: 2009-192</b> Group marker carrier	<a href="http://www.wago.com/2009-192">www.wago.com/2009-192</a>
	<b>Nr. articol: 2009-193</b> Group marker carrier	<a href="http://www.wago.com/2009-193">www.wago.com/2009-193</a>
	<b>Nr. articol: 2009-198</b> Adaptor	<a href="http://www.wago.com/2009-198">www.wago.com/2009-198</a>
	<b>Nr. articol: 248-501</b> Miniature WSB Quick marking system; plain; Marker width 5 mm; 10 strips with 10 markers per card	<a href="http://www.wago.com/248-501">www.wago.com/248-501</a>
	<b>Nr. articol: 248-501/000-002</b> Mini-WSB marking card; as card; not stretchable; plain; snap-on type; yellow	<a href="http://www.wago.com/248-501/000-002">www.wago.com/248-501/000-002</a>

Supus modificărilor.

	<b>Nr. articol:</b> 248-501/000-005 Mini-WSB marking card; as card; not stretchable; plain; snap-on type; red	<a href="http://www.wago.com/248-501/000-005">www.wago.com/248-501/000-005</a>
	<b>Nr. articol:</b> 248-501/000-006 Mini-WSB marking card; as card; not stretchable; plain; snap-on type; blue	<a href="http://www.wago.com/248-501/000-006">www.wago.com/248-501/000-006</a>
	<b>Nr. articol:</b> 248-501/000-007 Mini-WSB marking card; as card; not stretchable; plain; snap-on type; gray	<a href="http://www.wago.com/248-501/000-007">www.wago.com/248-501/000-007</a>
	<b>Nr. articol:</b> 248-501/000-012 Mini-WSB marking card; as card; not stretchable; plain; snap-on type; orange	<a href="http://www.wago.com/248-501/000-012">www.wago.com/248-501/000-012</a>
	<b>Nr. articol:</b> 248-501/000-017 Mini-WSB marking card; as card; not stretchable; plain; snap-on type; light green	<a href="http://www.wago.com/248-501/000-017">www.wago.com/248-501/000-017</a>
	<b>Nr. articol:</b> 248-501/000-023 Mini-WSB marking card; as card; not stretchable; plain; snap-on type; green	<a href="http://www.wago.com/248-501/000-023">www.wago.com/248-501/000-023</a>
	<b>Nr. articol:</b> 248-501/000-024 Mini-WSB marking card; as card; not stretchable; plain; snap-on type; violet	<a href="http://www.wago.com/248-501/000-024">www.wago.com/248-501/000-024</a>
	<b>Nr. articol:</b> 793-501 WMB marking card; as card; not stretchable; plain; snap-on type; white	<a href="http://www.wago.com/793-501">www.wago.com/793-501</a>
	<b>Nr. articol:</b> 793-501/000-002 WMB marking card; as card; not stretchable; plain; snap-on type; yellow	<a href="http://www.wago.com/793-501/000-002">www.wago.com/793-501/000-002</a>
	<b>Nr. articol:</b> 793-501/000-005 WMB marking card; as card; not stretchable; plain; snap-on type; red	<a href="http://www.wago.com/793-501/000-005">www.wago.com/793-501/000-005</a>
	<b>Nr. articol:</b> 793-501/000-006 WMB marking card; as card; not stretchable; plain; snap-on type; blue	<a href="http://www.wago.com/793-501/000-006">www.wago.com/793-501/000-006</a>
	<b>Nr. articol:</b> 793-501/000-007 WMB marking card; as card; not stretchable; plain; snap-on type; gray	<a href="http://www.wago.com/793-501/000-007">www.wago.com/793-501/000-007</a>
	<b>Nr. articol:</b> 793-501/000-012 WMB marking card; as card; not stretchable; plain; snap-on type; orange	<a href="http://www.wago.com/793-501/000-012">www.wago.com/793-501/000-012</a>

Supus modificărilor.

WAGO Kontakttechnik GmbH & Co. KG  
/Representative Office Romania  
Sos. Pipera-Tunari nr. 1/1  
building 1, 2nd floor | 077190 Voluntari, Ilfov  
Tel.: +40-(0)31 421 85 68 | Email: info-RO@wago.com

Aveți întrebări despre produsele noastre?  
Vă stăm la dispoziție pentru preluarea apelului la +40 (0) 31 421 85 68.

**Nr. articol: 793-501/000-017**

WMB marking card; as card; not stretchable; plain; snap-on type; light green

[www.wago.com/793-501/000-017](http://www.wago.com/793-501/000-017)**Nr. articol: 793-501/000-023**

WMB marking card; as card; not stretchable; plain; snap-on type; green

[www.wago.com/793-501/000-023](http://www.wago.com/793-501/000-023)**Nr. articol: 793-501/000-024**

WMB marking card; as card; not stretchable; plain; snap-on type; violet

[www.wago.com/793-501/000-024](http://www.wago.com/793-501/000-024)**Nr. articol: 793-5501**

WMB marking card; as card; for terminal block width 5 - 17.5 mm; stretchable 5 - 5.2 mm; plain; snap-on type; white

[www.wago.com/793-5501](http://www.wago.com/793-5501)**Nr. articol: 793-5501/000-002**

WMB marking card; as card; for terminal block width 5 - 17.5 mm; stretchable 5 - 5.2 mm; plain; snap-on type; yellow

[www.wago.com/793-5501/000-002](http://www.wago.com/793-5501/000-002)**Nr. articol: 793-5501/000-005**

WMB marking card; as card; for terminal block width 5 - 17.5 mm; stretchable 5 - 5.2 mm; plain; snap-on type; red

[www.wago.com/793-5501/000-005](http://www.wago.com/793-5501/000-005)**Nr. articol: 793-5501/000-006**

WMB marking card; as card; for terminal block width 5 - 17.5 mm; stretchable 5 - 5.2 mm; plain; snap-on type; blue

[www.wago.com/793-5501/000-006](http://www.wago.com/793-5501/000-006)**Nr. articol: 793-5501/000-007**

WMB marking card; as card; for terminal block width 5 - 17.5 mm; stretchable 5 - 5.2 mm; plain; snap-on type; gray

[www.wago.com/793-5501/000-007](http://www.wago.com/793-5501/000-007)**Nr. articol: 793-5501/000-012**

WMB marking card; as card; for terminal block width 5 - 17.5 mm; stretchable 5 - 5.2 mm; plain; snap-on type; orange

[www.wago.com/793-5501/000-012](http://www.wago.com/793-5501/000-012)**Nr. articol: 793-5501/000-014**

WMB marking card; as card; for terminal block width 5 - 17.5 mm; stretchable 5 - 5.2 mm; plain; snap-on type; brown

[www.wago.com/793-5501/000-014](http://www.wago.com/793-5501/000-014)**Nr. articol: 793-5501/000-017**

WMB marking card; as card; for terminal block width 5 - 17.5 mm; stretchable 5 - 5.2 mm; plain; snap-on type; green

[www.wago.com/793-5501/000-017](http://www.wago.com/793-5501/000-017)**Nr. articol: 793-5501/000-023**















WMB marking card; as card; for terminal block width 5 - 17.5 mm; stretchable 5 - 5.2 mm; plain; snap-on type; light green

[www.wago.com/793-5501/000-023](http://www.wago.com/793-5501/000-023)**Nr. articol: 793-5501/000-024**

WMB marking card; as card; for terminal block width 5 - 17.5 mm; stretchable 5 - 5.2 mm; plain; snap-on type; violet

[www.wago.com/793-5501/000-024](http://www.wago.com/793-5501/000-024)**Push-In type wire jumper****Nr. articol: 2009-412**

Supus modificărilor.

	Push-in type wire jumper; insulated; wire length 60 mm; Conductor cross section 1.5 mm <sup>2</sup> ; suitable for 2001, 2002, 2003 and 2022 Series rail-mounted terminal blocks; black	<a href="http://www.wago.com/2009-412">www.wago.com/2009-412</a>
	<b>Nr. articol: 2009-414</b> Push-in type wire jumper; insulated; wire length 110 mm; Conductor cross section 1.5 mm <sup>2</sup> ; suitable for 2001, 2002, 2003 and 2022 Series rail-mounted terminal blocks; black	<a href="http://www.wago.com/2009-414">www.wago.com/2009-414</a>
	<b>Nr. articol: 2009-414/000-005</b> Push-in type wire jumper; insulated; wire length 110 mm; Conductor cross section 1.5 mm <sup>2</sup> ; suitable for 2001, 2002, 2003 and 2022 Series rail-mounted terminal blocks; red	<a href="http://www.wago.com/2009-414/000-005">www.wago.com/2009-414/000-005</a>
	<b>Nr. articol: 2009-414/000-006</b> Push-in type wire jumper; insulated; wire length 110 mm; Conductor cross section 1.5 mm <sup>2</sup> ; suitable for 2001, 2002, 2003 and 2022 Series rail-mounted terminal blocks; blue	<a href="http://www.wago.com/2009-414/000-006">www.wago.com/2009-414/000-006</a>
	<b>Nr. articol: 2009-416</b> Push-in type wire jumper; insulated; wire length 250 mm; Conductor cross section 1.5 mm <sup>2</sup> ; suitable for 2001, 2002, 2003 and 2022 Series rail-mounted terminal blocks; black	<a href="http://www.wago.com/2009-416">www.wago.com/2009-416</a>
<b>Coding</b>		
	<b>Nr. articol: 2022-100</b> Carrier with 6 coding pins; for coding of female plugs; orange	<a href="http://www.wago.com/2022-100">www.wago.com/2022-100</a>
<b>Female plug</b>		
	<b>Nr. articol: 2022-101</b> 1-conductor female plug; 2.5 mm <sup>2</sup> ; 1-pole; 2,50 mm <sup>2</sup> ; gray	<a href="http://www.wago.com/2022-101">www.wago.com/2022-101</a>
	<b>Nr. articol: 2022-102/999-953</b> 1-conductor female plug; 2.5 mm <sup>2</sup> ; 2-pole; 2,50 mm <sup>2</sup> ; gray	<a href="http://www.wago.com/2022-102/999-953">www.wago.com/2022-102/999-953</a>
	<b>Nr. articol: 2022-103/000-038/999-953</b> 1-conductor female plug; 2.5 mm <sup>2</sup> ; 3-pole; 2,50 mm <sup>2</sup> ; gray, blue, green-yellow	<a href="http://www.wago.com/2022-103/000-038/999-953">www.wago.com/2022-103/000-038/999-953</a>
	<b>Nr. articol: 2022-103/000-039/999-953</b> 1-conductor female plug; 2.5 mm <sup>2</sup> ; 3-pole; 2,50 mm <sup>2</sup> ; green-yellow, blue, gray	<a href="http://www.wago.com/2022-103/000-039/999-953">www.wago.com/2022-103/000-039/999-953</a>
	<b>Nr. articol: 2022-103/999-953</b> 1-conductor female plug; 2.5 mm <sup>2</sup> ; 3-pole; 2,50 mm <sup>2</sup> ; gray	<a href="http://www.wago.com/2022-103/999-953">www.wago.com/2022-103/999-953</a>
	<b>Nr. articol: 2022-104/000-038/999-953</b> 1-conductor female plug; 2.5 mm <sup>2</sup> ; 4-pole; 2,50 mm <sup>2</sup> ; gray, blue, green-yellow	<a href="http://www.wago.com/2022-104/000-038/999-953">www.wago.com/2022-104/000-038/999-953</a>
	<b>Nr. articol: 2022-104/000-039/999-953</b> 1-conductor female plug; 2.5 mm <sup>2</sup> ; 4-pole; 2,50 mm <sup>2</sup> ; green-yellow/blue/gray	<a href="http://www.wago.com/2022-104/000-039/999-953">www.wago.com/2022-104/000-039/999-953</a>
	<b>Nr. articol: 2022-104/999-953</b> 1-conductor female plug; 2.5 mm <sup>2</sup> ; 4-pole; 2,50 mm <sup>2</sup> ; gray	<a href="http://www.wago.com/2022-104/999-953">www.wago.com/2022-104/999-953</a>

Supus modificărilor.



**Nr. articol:** 2022-105/000-038/999-953

1-conductor female plug; 2.5 mm<sup>2</sup>; 5-pole; 2,50 mm<sup>2</sup>; gray, blue, green-yellow

[www.wago.com/2022-105/000-038/999-953](http://www.wago.com/2022-105/000-038/999-953)



**Nr. articol:** 2022-105/000-039/999-953

1-conductor female plug; 2.5 mm<sup>2</sup>; 5-pole; 2,50 mm<sup>2</sup>; green-yellow, blue, gray

[www.wago.com/2022-105/000-039/999-953](http://www.wago.com/2022-105/000-039/999-953)



**Nr. articol:** 2022-105/999-953

1-conductor female plug; 2.5 mm<sup>2</sup>; 5-pole; 2,50 mm<sup>2</sup>; gray

[www.wago.com/2022-105/999-953](http://www.wago.com/2022-105/999-953)



**Nr. articol:** 2022-106/000-038/999-953

1-conductor female plug; 2.5 mm<sup>2</sup>; 6-pole; 2,50 mm<sup>2</sup>; gray, blue, green-yellow

[www.wago.com/2022-106/000-038/999-953](http://www.wago.com/2022-106/000-038/999-953)



**Nr. articol:** 2022-106/000-039/999-953

1-conductor female plug; 2.5 mm<sup>2</sup>; 6-pole; 2,50 mm<sup>2</sup>; green-yellow, blue, gray

[www.wago.com/2022-106/000-039/999-953](http://www.wago.com/2022-106/000-039/999-953)



**Nr. articol:** 2022-106/999-953

1-conductor female plug; 2.5 mm<sup>2</sup>; 6-pole; 2,50 mm<sup>2</sup>; gray

[www.wago.com/2022-106/999-953](http://www.wago.com/2022-106/999-953)



**Nr. articol:** 2022-107/999-953

1-conductor female plug; 2.5 mm<sup>2</sup>; 7-pole; 2,50 mm<sup>2</sup>; gray

[www.wago.com/2022-107/999-953](http://www.wago.com/2022-107/999-953)



**Nr. articol:** 2022-108/999-953

1-conductor female plug; 2.5 mm<sup>2</sup>; 8-pole; 2,50 mm<sup>2</sup>; gray

[www.wago.com/2022-108/999-953](http://www.wago.com/2022-108/999-953)

#### End plate



**Nr. articol:** 2022-1391

End and intermediate plate; 1 mm thick; gray

[www.wago.com/2022-1391](http://www.wago.com/2022-1391)



**Nr. articol:** 2022-1392

End and intermediate plate; 1 mm thick; orange

[www.wago.com/2022-1392](http://www.wago.com/2022-1392)

## Descărcări

### Documentation

#### Additional Information

Technical explanations

Apr 3, 2019

pdf  
2,1 MB

Descărcare

## CAD/CAE-Data

### CAD data

Supus modificărilor.

WAGO Kontakttechnik GmbH & Co. KG  
/Representative Office Romania  
Sos. Pipera-Tunari nr. 1/1  
building 1, 2nd floor | 077190 Voluntari, Ilfov  
Tel.: +40-(0)31 421 85 68 | Email: info-RO@wago.com

Aveți întrebări despre produsele noastre?  
Vă stăm la dispoziție pentru preluarea apelului la +40 (0) 31 421 85 68.

2D/3D Models 2022-1307/999-953

[URL](#)

[Descărcare](#)

#### CAE data

EPLAN Data Portal 2022-1307/999-953

[URL](#)

[Descărcare](#)

WSCAD Universe 2022-1307/999-953

[URL](#)

[Descărcare](#)

## Installation Notes

### Installation

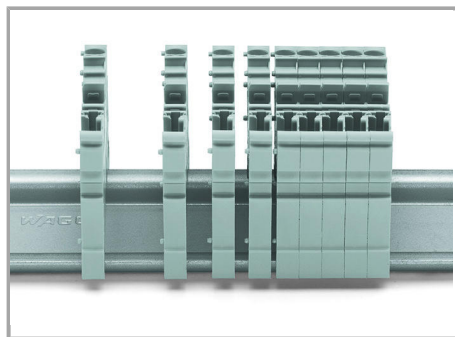

Snap individual carrier terminal blocks onto the carrier rail and slide together.

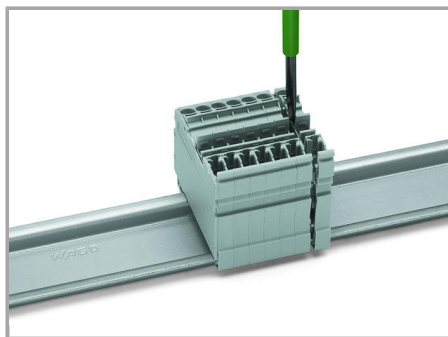

Open the assembly by laterally sliding a block via operating tool (3.5 x 0.5 mm blade).

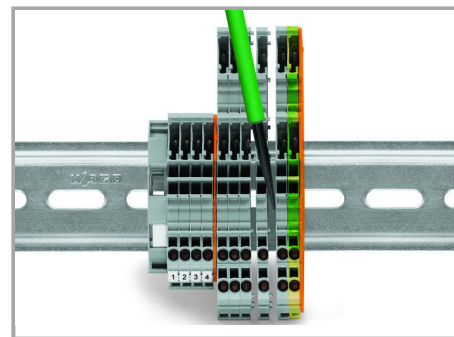

Separate terminal block assembly and slide individual terminal blocks laterally using an operating tool.

### Inserting a conductor

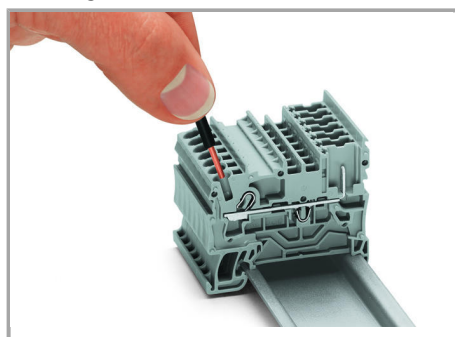

Push-in CAGE CLAMP® enables solid conductors and fine-stranded conductors with ferrules to be connected by simply pushing them into the unit.

### Commoning

Supus modificărilor.



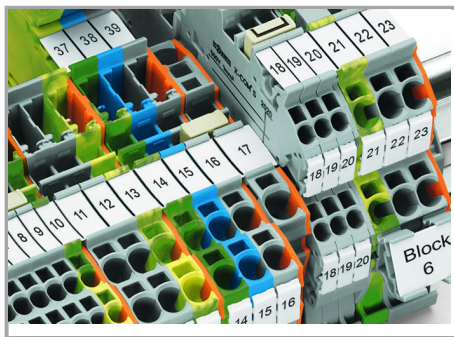

Commoning X-COM®S-SYSTEM Terminal Blocks using jumpers for TOPJOB® S Terminal Blocks. An end plate provides connection to TOPJOB® S Terminal Blocks. 2020 and 2022 Series Terminal Blocks are combinable. Jumper slots are on the same level for both series.

#### Testing

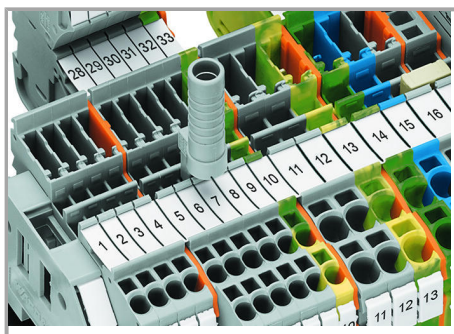

Test plug adapter (2009-174) for 4 mm test plugs or banana plugs – also suitable for X-COM®S-SYSTEM-MINI Terminal Blocks.

#### Coding

Supus modificărilor.

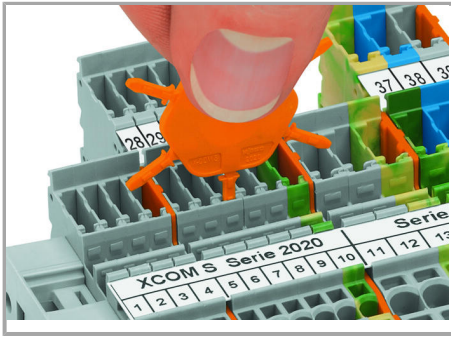

Insert coding pin into the corresponding slot and twist it off.

#### Ex Application

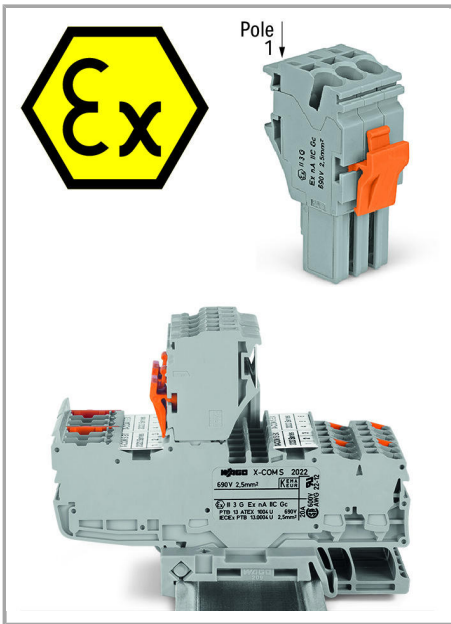

630 V = rated voltage for use in Zone 2 hazardous areas, "nA" type of protection

"n" refers to an ignition protection class in Zone 2:

This zone covers areas in which a dangerous, explosive atmosphere consisting of gases, vapors or dust is

Supus modificărilor.

unlikely to exist and will only persist for a short period if it does.

“A” means: non-sparking (function modules without relays/switches)

Ex marking:

“Ex” sign and extended item number “.../999-953” are printed on the side of both carrier terminal blocks and female plugs with Ex approval.

Shorter locking lever (factory-mounted) makes accidental disconnection more difficult.

### Marking

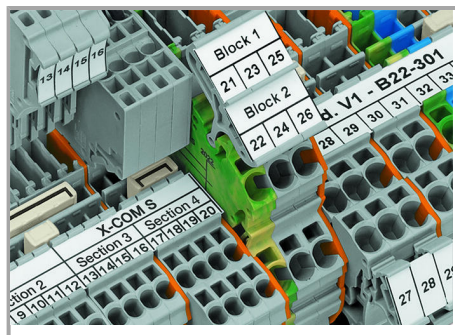

Clear marking via large marking area

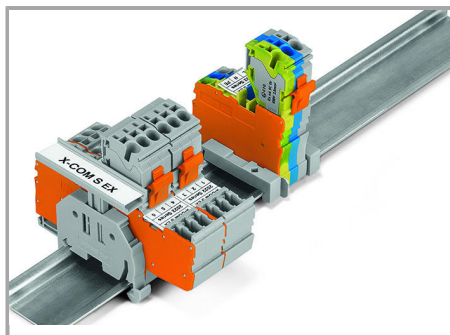

Group marking with height-adjustable group marker carrier (2009 163)

### Safety

Supus modificărilor.

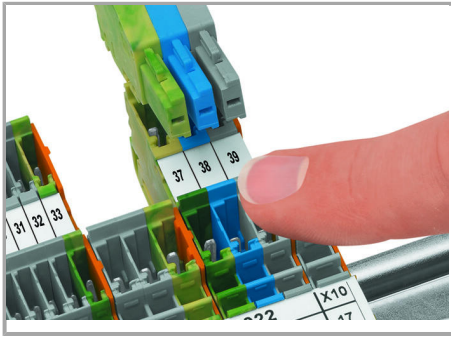

Carrier terminal blocks and female plugs are touch-proof.

## Familie de produse

### **X-COM S**

Afișare globală produse din familie.

Supus modificărilor.