

## Descriere articol

- Protected against mismatching and maintenance-free
- Push-in CAGE CLAMP® spring pressure connection technology allows solid conductors to be simply pushed into a unit

Supus modificărilor.



- Compact design with 4.4 mm pole spacing
- When assembled, the installation connectors complies with IP40 and are suitable for easily accessible areas

**Note:**

All connectors for mounted installations (snap-in versions for lighting fixtures or devices, all types of PCB and distribution connectors) are factory-equipped with locking levers to ensure plugs and sockets are securely locked. Additional locking levers are only required for flying leads (plug /socket).

**Note on mismatching protection:**

All WINSTA<sup>®</sup> components are 100% protected against mismatching when:

- plugging different numbers of poles
- plugging while rotated 180
- plugging while laterally staggered
- plugging one pole

**Safety information 1:**

Application note for the U.S. market (USR): Some versions may also be used for current interruption in accordance with the UL certificate in select applications with currents below 5 A and voltages up to 600 V. For further information, please contact your local sales office.

**Date****Electrical data**

Note on Contact Resistance

approx. 1 mΩ of contact resistance approx. 0.25 mΩ contact transition plug/socket

**Ratings per IEC/EN 60664-1**

Ratings per	IEC/EN 60664-1
Nominal voltage (III/3)	250 V
Rated surge voltage (III/3)	4 kV
Rated current	16 A
Legend (ratings)	(III / 3) ≙ Overvoltage category III / Pollution degree 3

**Approvals per UL 1977**

Rated voltage UL 1977	600 V
Rated current UL 1977	14 A

**Connection data**

Connection technology	Push-in CAGE CLAMP <sup>®</sup>
Actuation type	Operating tool Push-in
Nominal cross-section	1,5 mm <sup>2</sup>
Solid conductor	0,25 ... 1,5 mm <sup>2</sup> / 22 ... 16 AWG

Supus modificărilor.

WAGO Kontakttechnik GmbH & Co. KG  
/Representative Office Romania  
Sos. Pipera-Tunari nr. 1/1  
building 1, 2nd floor | 077190 Voluntari, Ilfov  
Tel.: +40-(0)31 421 85 68 | Email: info-RO@wago.com

Aveți întrebări despre produsele noastre?  
Vă stăm la dispoziție pentru preluarea apelului la +40 (0) 31 421 85 68.



Solid conductor; push-in termination	0,75 ... 1,5 mm <sup>2</sup> / 20 ... 16 AWG
Stranded conductor	0,25 ... 1 mm <sup>2</sup> / 22 ... 18 AWG
Fine-stranded conductor	0,25 ... 1,5 mm <sup>2</sup> / 22 ... 16 AWG
Fine-stranded conductor; with insulated ferrule	0,25 ... 0,75 mm <sup>2</sup> / 22 ... 20 AWG
Fine-stranded conductor; with uninsulated ferrule	0,25 ... 0,75 mm <sup>2</sup> / 22 ... 20 AWG
Fine-stranded conductor; with ferrule; push-in termination	0,75 mm <sup>2</sup> / 20 AWG
Strip length	9 mm / 0.35 inch
Note (strip length)	see also packaging or instructions
Pole No.	2
Total number of connection points	2
Total number of potentials	2
Connectable sheathed cable diameter	3,8 ... 8,2 mm
Conductor entry direction to mating direction	0°
Strip length (outer insulation)	17,5 mm

### Geometrical Data

Pin spacing	4,4 mm / 0.173 inch
Width	15,6 mm / 0.614 inch
Height	13,2 mm / 0.52 inch
Depth	46,5 mm / 1.831 inch

### Mechanical data

Coding	A
Mating force of a plug-in connection	approx. 20 ... 70 N (depending on pole number)
Retention force of a plug-in connection	Locked: > 80 N
Unmating force of a plug-in connection	Unlocked: approx. 20 ... 70 N (depending on pole number)
Number of mating cycles	200, without resistive load 100, with resistive load $I_N = 16$ A, tested (1.5 mm <sup>2</sup> /AWG 16)
Marking	L N
Protection type	IP40
Potential marking	L N
Application	General mains applications

Supus modificărilor.

## Plug connection

Contact type (pluggable connector)	Male connector/plug
Connector (connection type)	for conductor
Mismatching protection	Yes
Locking of plug-in connection	locking lever
Locking lever	retrofitable
Strain relief	strain relief housing, short

## Material Data

Color	black
Insulation material	Polyamide 66 (PA 66)
Clamping spring material	Chrome nickel spring steel (CrNi)
Contact material	Copper or copper alloy (surface-treated)
Weight	4,6 g

## Environmental Requirements

Processing temperature	-5 ... +40 °C
Continuous operating temperature	-35 ... +85 °C
Note on continuous operating temperature	Insulating parts for temperatures $\leq 105$ °C

## Commercial data

Packaging type	BOX
Country of origin	DE
GTIN	4055143463638
Customs tariff number	85366990990

## Aprobări / certificate

### Ship Approvals













Emblemă	Aprobare	Text de aprobare suplimentar	Nume certificat
	LR Lloyds Register	EN 61535	08 /20047 (E2)

Supus modificărilor.

WAGO Kontakttechnik GmbH & Co. KG  
/Representative Office Romania  
Sos. Pipera-Tunari nr. 1/1  
building 1, 2nd floor | 077190 Voluntari, Ilfov  
Tel.: +40-(0)31 421 85 68 | Email: info-RO@wago.com

Aveți întrebări despre produsele noastre?  
Vă stăm la dispoziție pentru preluarea apelului la +40 (0) 31 421 85 68.

## Counterpart

	<b>Nr. articol</b> 890-102 Socket; with strain relief housing; 2-pole; Cod. A; 1,50 mm <sup>2</sup> ; black	<a href="http://www.wago.com/890-102">www.wago.com/890-102</a>
	<b>Nr. articol</b> 890-1606 T-distribution connector; 2-pole; Cod. A; 1 input; 2 outputs; 2 locking levers; black	<a href="http://www.wago.com/890-1606">www.wago.com/890-1606</a>
	<b>Nr. articol</b> 890-1615 T-distribution connector; 2-pole; Cod. A; 1 input; 2 outputs; 3 locking levers; for flying leads; black	<a href="http://www.wago.com/890-1615">www.wago.com/890-1615</a>
	<b>Nr. articol</b> 890-1634 h-distribution connector; 2-pole; Cod. A; 1 input; 2 outputs; outputs on one side; 2 locking levers; black	<a href="http://www.wago.com/890-1634">www.wago.com/890-1634</a>
	<b>Nr. articol</b> 890-1636 h-distribution connector; 2-pole; Cod. A; 1 input; 2 outputs; outputs on one side; 3 locking levers; for flying leads; black	<a href="http://www.wago.com/890-1636">www.wago.com/890-1636</a>
	<b>Nr. articol</b> 890-202 Socket; 2-pole; Cod. A; 1,50 mm <sup>2</sup> ; black	<a href="http://www.wago.com/890-202">www.wago.com/890-202</a>
	<b>Nr. articol</b> 890-202/342-000 Socket; with strain relief housing; 2-pole; Cod. A; 1,50 mm <sup>2</sup> ; black	<a href="http://www.wago.com/890-202/342-000">www.wago.com/890-202/342-000</a>
	<b>Nr. articol</b> 890-702 Snap-in socket; 2-pole; Cod. A; 1,50 mm <sup>2</sup> ; black	<a href="http://www.wago.com/890-702">www.wago.com/890-702</a>
	<b>Nr. articol</b> 890-802 Socket for PCBs; straight; 2-pole; Cod. A	<a href="http://www.wago.com/890-802">www.wago.com/890-802</a>
	<b>Nr. articol</b> 890-802/011-000 Socket for PCBs; angled; 2-pole; Cod. A; black	<a href="http://www.wago.com/890-802/011-000">www.wago.com/890-802/011-000</a>
	<b>Nr. articol</b> 891-8992/005-101 pre-assembled interconnecting cable; Eca; Socket/plug; 2-pole; Cod. A; H05VV-F 2 x 1.0 mm <sup>2</sup> ; 1 m; 1,00 mm <sup>2</sup> ; black	<a href="http://www.wago.com/891-8992/005-101">www.wago.com/891-8992/005-101</a>
	<b>Nr. articol</b> 891-8992/105-101 pre-assembled connecting cable; Eca; Socket/open-ended; 2-pole; Cod. A; H05VV-F 2 x 1.0 mm <sup>2</sup> ; 1 m; 1,00 mm <sup>2</sup> ; black	<a href="http://www.wago.com/891-8992/105-101">www.wago.com/891-8992/105-101</a>

Supus modificărilor.

## Produse compatibile

### tools



Nr. articol: 210-719

Operating tool; Blade: 2.5 x 0.4 mm; with a partially insulated shaft

[www.wago.com/210-719](http://www.wago.com/210-719)

## Installation Notes

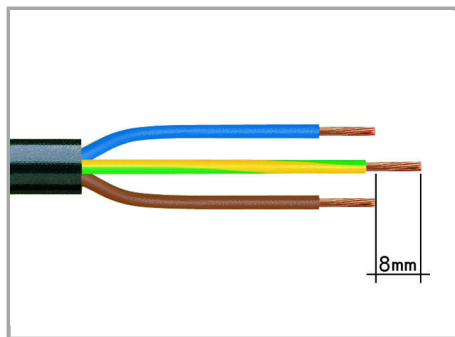

1. Strip length, outer insulation = 30 mm (2-pole), 37 mm (3-pole), 45 mm (4- and 5-pole)

2. Strip length = 9 mm

3. Extended ground conductor = 8 mm

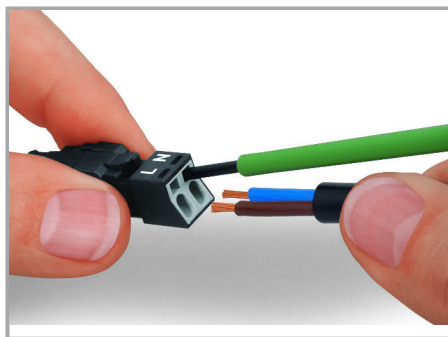

To terminate fine-stranded conductors, open the clamping unit via screwdriver (2.5 mm blade width) and insert a stripped conductor until it hits backstop. Terminate solid conductors by simply pushing them in.

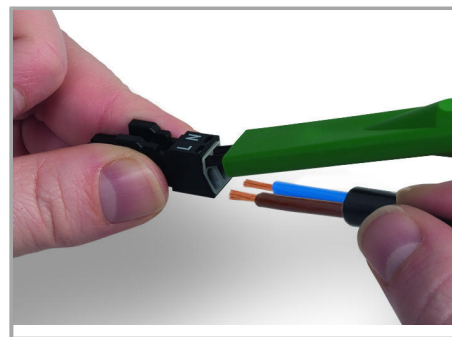

To terminate fine-stranded conductors, open clamping units via operating tool (890-382) and insert stripped conductors until they hit backstop.

Terminate solid conductors by simply pushing them in.

Supus modificărilor.



To terminate fine-stranded conductors, open clamping units via operating tool (890-383) and insert stripped conductors until they hit backstop.

Terminate solid conductors by simply pushing them in.

#### Installation

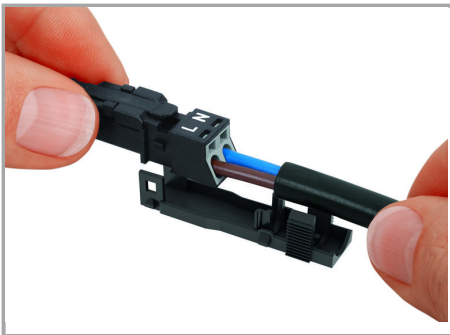

Latch wired connector onto the base of the strain relief housing.

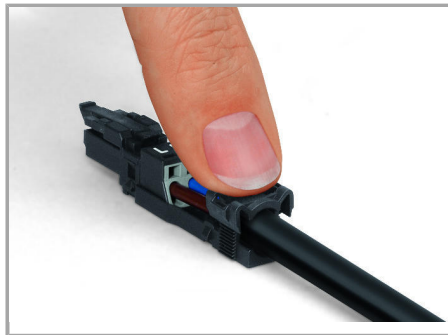

Push down strain relief clamp by hand.



Push down strain relief clamp via 2.5 mm screwdriver alternately on both sides.

Supus modificărilor.

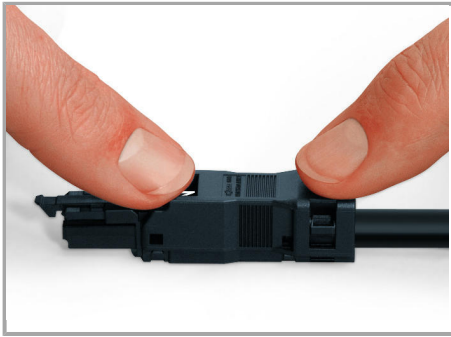

Latch the top of the strain relief housing.



The printed marking of the connector is clearly visible in the openings of the strain relief housing.

## Familie de produse

*WINSTA*® MINI

Afișare globală produse din familie.

Supus modificărilor.