

Fișă tehnică | Număr articol: 2002-2972

Double-deck disconnect terminal block; with pivoting knife disconnect; same profile as double-deck, double-disconnect terminal block; N/L; for DIN-rail 35 x 15 and 35 x 7.5; 2.5 mm²; Push-in CAGE CLAMP®; 2,50 mm²; gray

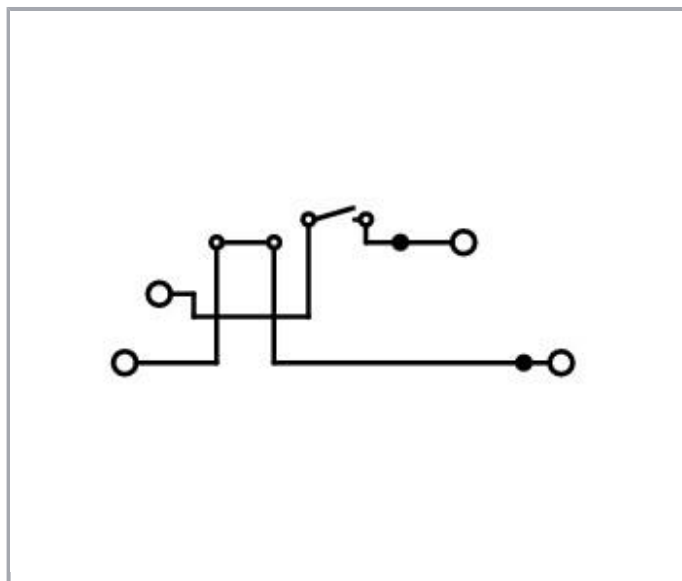

www.wago.com/2002-2972

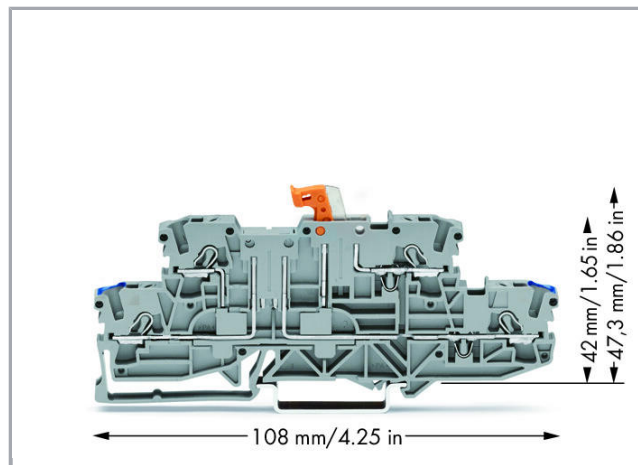
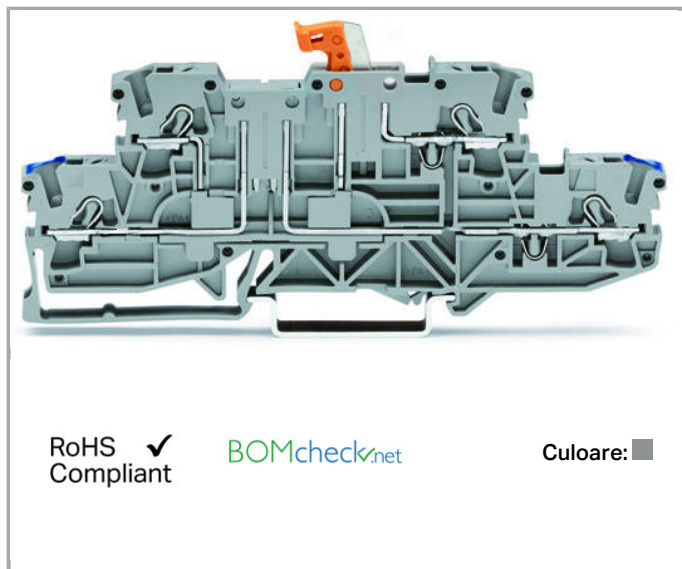

Date

Electrical data

Supus modificărilor.

WAGO Kontakttechnik GmbH & Co. KG
/Representative Office Romania
Sos. Pipera-Tunari nr. 1/1
building 1, 2nd floor | 077190 Voluntari, Ilfov
Tel.: +40-(0)31 421 85 68 | Email: info-RO@wago.com

Aveți întrebări despre produsele noastre?
Vă stăm la dispoziție pentru preluarea apelului la +40 (0) 31 421 85 68.

Ratings per IEC/EN 60664-1

| | |
|-----------------------------|---|
| Ratings per | IEC/EN 60947-7-1 |
| Nominal voltage (III/3) | 400 V |
| Rated surge voltage (III/3) | 6 kV |
| Rated current | 16 A |
| Legend (ratings) | (III / 3) ≙ Overvoltage category III / Pollution degree 3 |

Approvals per UL 1059

| | |
|--------------------------------|---------|
| Rated voltage UL (Use Group B) | 300 V |
| Rated current UL (Use Group B) | 15 A |
| Rated voltage UL (Use Group C) | 300 V |
| Rated current UL (Use Group C) | 15 A |
| Approvals per | UL 1059 |

Approvals per CSA

| | |
|---------------------------------|-------|
| Rated voltage CSA (Use Group B) | 300 V |
| Rated current CSA (Use Group B) | 15 A |
| Rated voltage CSA (Use Group C) | 150 V |
| Rated current CSA (Use Group C) | 15 A |

Connection data

| | |
|--|--|
| Connection technology | Push-in CAGE CLAMP® |
| Actuation type | Push-in Open Tool Slot |
| Connectable conductor materials | Copper |
| Nominal cross-section | 2,5 mm ² |
| Solid conductor | 0,25 ... 4 mm ² / 22 ... 12 AWG |
| Solid conductor; push-in termination | 0,75 ... 4 mm ² / 18 ... 12 AWG |
| Fine-stranded conductor | 0,25 ... 4 mm ² / 22 ... 12 AWG |
| Fine-stranded conductor; with insulated ferrule | 1 ... 2,5 mm ² / 18 ... 12 AWG |
| Fine-stranded conductor; with ferrule; push-in termination | 1 ... 2,5 mm ² / 18 ... 12 AWG |
| Strip length | 10 ... 12 mm / 0.39 ... 0.47 inch |
| Total number of connection points | 4 |
| Total number of potentials | 4 |
| Number of levels | 2 |

Supus modificărilor.

WAGO Kontakttechnik GmbH & Co. KG
/Representative Office Romania
Sos. Pipera-Tunari nr. 1/1
building 1, 2nd floor | 077190 Voluntari, Ilfov
Tel.: +40-(0)31 421 85 68 | Email: info-RO@wago.com

Aveți întrebări despre produsele noastre?
Vă stăm la dispoziție pentru preluarea apelului la +40 (0) 31 421 85 68.



| | |
|--------------------------------|---|
| Wiring type | Front-entry wiring |
| Note (conductor cross-section) | Depending on the conductor characteristic, a conductor with a smaller cross-section can also be inserted via push-in termination. |

Geometrical Data

| | |
|------------------------------------|---------------------|
| Width | 5,2 mm / 0.205 inch |
| Height from upper-edge of DIN-rail | 42 mm / 1.654 inch |
| Depth | 108 mm / 4.252 inch |

Mechanical data

| | |
|-------------------|-----------------|
| Design | horizontal type |
| Mounting type | DIN-35 rail |
| Potential marking | N/L |
| Marking level | Side marking |

Material Data

| | |
|---------------------|----------------------|
| Color | gray |
| Insulation material | Polyamide 66 (PA 66) |
| Fire load | 0,315 MJ |
| Weight | 17,4 g |

Commercial data

| | |
|-----------------------|---------------|
| Product Group | 22 (TOPJOB S) |
| Packaging type | BOX |
| Country of origin | DE |
| GTIN | 4045454382896 |
| Customs tariff number | 85365080900 |

Aprobări / certificate**Ex-Approvals**

| Emblemă | Aprobare | Text de aprobare suplimentar | Nume certificat |
|--|--|------------------------------|----------------------|
|  | AEx Underwriters Laboratories Inc. | UL 60079 | 20190704- E185892 |
| | ATEX KIWA Netherlands B.V. | EN 60079 | KIWA 17ATEX0030 |

Supus modificărilor.

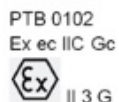

WAGO Kontakttechnik GmbH & Co. KG
/Representative Office Romania
Sos. Pipera-Tunari nr. 1/1
building 1, 2nd floor | 077190 Voluntari, Ilfov
Tel.: +40-(0)31 421 85 68 | Email: info-RO@wago.com

Aveți întrebări despre produsele noastre?
Vă stăm la dispoziție pentru preluarea apelului la +40 (0) 31 421 85 68.





| | | | |
|--|--------------------------------|----------|------------------------|
|  | IECEX KIWA Netherlands B.V. | EN 60079 | IECEX KIWA 17.0014U |
|--|--------------------------------|----------|------------------------|

Country specific Approvals

| Emblemă | Aprobare | Text de aprobare suplimentar | Nume certificat |
|---|---------------------------------------|------------------------------|-----------------|
|  | CCA DEKRA Certification B.V. | EN 60947 | NTR NL 7730 |
|  | CSA DEKRA Certification B.V. | C22.2 No. 158 | 1536069 |
|  | KEMA/KEUR DEKRA Certification B.V. | EN 60947 | 71- 107687 |

Ship Approvals

| Emblemă | Aprobare | Text de aprobare suplimentar | Nume certificat |
|--|--|------------------------------|--------------------------|
|  | ABS American Bureau of Shipping | EN 60947 | 20- HG1941090- PDA |
|  | DNV GL Det Norske Veritas, Germanischer Lloyd | - | TAE00001V2 |

UL-Approvals

| Emblemă | Aprobare | Text de aprobare suplimentar | Nume certificat |
|--|--------------------------------------|------------------------------|-----------------|
|  | UR Underwriters Laboratories Inc. | UL 1059 | E45172 |

Supus modificărilor.





WAGO Kontakttechnik GmbH & Co. KG
/Representative Office Romania
Sos. Pipera-Tunari nr. 1/1
building 1, 2nd floor | 077190 Voluntari, Ilfov
Tel.: +40-(0)31 421 85 68 | Email: info-RO@wago.com

Aveți întrebări despre produsele noastre?
Vă stăm la dispoziție pentru preluarea apelului la +40 (0) 31 421 85 68.

Counterpart

Produse compatibile

General accessories

| | | |
|--|---|--|
|  | Nr. articol: 2002-880/1000-411 Component plug; 2-pole; with diode 1N4007; 10.4 mm wide; Operating temperature 85°C max.; gray | www.wago.com/2002-880/1000-411 |
|  | Nr. articol: 2002-880/1000-541 Component plug; 2-pole; LED (red); 10.4 mm wide; Operating temperature 85°C max.; gray | www.wago.com/2002-880/1000-541 |
|  | Nr. articol: 2002-880/1000-542 LED module; with red LED; 10.4 mm wide; 30 - 65 V; Operating temperature 85°C max. | www.wago.com/2002-880/1000-542 |
|  | Nr. articol: 2002-880/1000-836 Component plug; 2-pole; LED (red); 10.4 mm wide; Operating temperature 85°C max.; gray | www.wago.com/2002-880/1000-836 |



plug

| | | |
|--|--|--|
|  | Nr. articol: 2002-880 Empty component plug housing; 10.4 mm wide; 2-pole; Type 4; gray | www.wago.com/2002-880 |
|--|--|--|

















Protective Warning Marker

| | | |
|--|---|--|
|  | Nr. articol: 2002-115 Protective warning marker; with high-voltage symbol, black; for 5 terminal blocks; yellow | www.wago.com/2002-115 |
|--|---|--|













check

| | | |
|--|---|--|
|  | Nr. articol: 2002-511 Modular TOPJOB®S connector; modular; for jumper contact slot; 1-pole; 2,50 mm ² ; gray | www.wago.com/2002-511 |
|  | Nr. articol: 2002-549 Spacer module; modular; e.g., for bridging commoned terminal blocks; gray | www.wago.com/2002-549 |

Supus modificărilor.

| | | |
|--|--|--|
|  | Nr. articol: 2002-552 Modular TOPJOB®S connector; modular; for jumper contact slot; 2-pole; 2,50 mm ² ; gray | www.wago.com/2002-552 |
|  | Nr. articol: 2002-553 Modular TOPJOB®S connector; modular; for jumper contact slot; 3-pole; 2,50 mm ² ; gray | www.wago.com/2002-553 |
|  | Nr. articol: 2002-554 Modular TOPJOB®S connector; modular; for jumper contact slot; 4-pole; 2,50 mm ² ; gray | www.wago.com/2002-554 |
|  | Nr. articol: 2002-555 Modular TOPJOB®S connector; modular; for jumper contact slot; 5-pole; 2,50 mm ² ; gray | www.wago.com/2002-555 |
|  | Nr. articol: 2002-556 Modular TOPJOB®S connector; modular; for jumper contact slot; 6-pole; 2,50 mm ² ; gray | www.wago.com/2002-556 |
|  | Nr. articol: 2002-557 Modular TOPJOB®S connector; modular; for jumper contact slot; 7-pole; 2,50 mm ² ; gray | www.wago.com/2002-557 |
|  | Nr. articol: 2002-558 Modular TOPJOB®S connector; modular; for jumper contact slot; 8-pole; 2,50 mm ² ; gray | www.wago.com/2002-558 |
|  | Nr. articol: 2002-559 Modular TOPJOB®S connector; modular; for jumper contact slot; 9-pole; 2,50 mm ² ; gray | www.wago.com/2002-559 |
|  | Nr. articol: 2002-560 Modular TOPJOB®S connector; modular; for jumper contact slot; 10-pole; 2,50 mm ² ; gray | www.wago.com/2002-560 |
|  | Nr. articol: 2002-611 TOPJOB®S L-type test plug module; modular; 1-pole; 2,50 mm ² ; gray | www.wago.com/2002-611 |
|  | Nr. articol: 2002-649 TOPJOB®S L-type spacer module; modular; e.g., for bridging commoned terminal blocks; gray | www.wago.com/2002-649 |
|  | Nr. articol: 2009-174 Test plug adapter; for 4 mm Ø test plugs; for testing TOPJOB®S rail-mounted terminal blocks; gray | www.wago.com/2009-174 |
|  | Nr. articol: 2009-182 Testing tap; for max. 2.5 mm ² ; tool-free connection for individual test wires 0.08 - 2.5 mm; gray | www.wago.com/2009-182 |
|  | Nr. articol: 210-136 Test plug; 2 mm Ø; with 500 mm cable; red | www.wago.com/210-136 |
| Marking accessories | | |
|  | Nr. articol: 2002-161 Adaptor | www.wago.com/2002-161 |
|  | Nr. articol: 2009-110 Marking strips; on reel; not stretchable; plain; snap-on type; white | www.wago.com/2009-110 |
|  | Nr. articol: 2009-115 WMB-Inline; for Smart Printer; 1500 pieces on roll; stretchable 5 - 5.2 mm; plain; snap-on type; white | www.wago.com/2009-115 |
| | Nr. articol: 2009-115/000-002 WMB-Inline; for Smart Printer; 1500 pieces on roll; stretchable 5 - 5.2 mm; plain; snap-on type; yellow /000-002 | www.wago.com/2009-115 |















Supus modificărilor.

| | | |
|---|--|--|
|  | Nr. articol: 2009-115/000-005 WMB-Inline; for Smart Printer; 1500 pieces on roll; stretchable 5 - 5.2 mm; plain; snap-on type; red | www.wago.com/2009-115/000-005 |
|  | Nr. articol: 2009-115/000-006 WMB-Inline; for Smart Printer; 1500 pieces on roll; stretchable 5 - 5.2 mm; plain; snap-on type; blue | www.wago.com/2009-115/000-006 |
|  | Nr. articol: 2009-115/000-007 WMB-Inline; for Smart Printer; 1500 pieces on roll; stretchable 5 - 5.2 mm; plain; snap-on type; gray | www.wago.com/2009-115/000-007 |
|  | Nr. articol: 2009-115/000-012 WMB-Inline; for Smart Printer; 1500 pieces on roll; stretchable 5 - 5.2 mm; plain; snap-on type; orange | www.wago.com/2009-115/000-012 |
|  | Nr. articol: 2009-115/000-017 WMB-Inline; for Smart Printer; 1500 pieces on roll; stretchable 5 - 5.2 mm; plain; snap-on type; light green | www.wago.com/2009-115/000-017 |
|  | Nr. articol: 2009-115/000-023 WMB-Inline; for Smart Printer; 1500 pieces on roll; stretchable 5 - 5.2 mm; plain; snap-on type; green | www.wago.com/2009-115/000-023 |
|  | Nr. articol: 2009-115/000-024 WMB-Inline; for Smart Printer; 1500 pieces on roll; stretchable 5 - 5.2 mm; plain; snap-on type; violet | www.wago.com/2009-115/000-024 |
|  | Nr. articol: 2009-135 WMB-Inline; for Smart Printer; on reel; stretchable 5 - 5.2 mm; plain; snap-on type; white | www.wago.com/2009-135 |
|  | Nr. articol: 2009-145 Mini-WSB Inline; for Smart Printer; 1700 pieces on roll; stretchable 5 - 5.2 mm; plain; snap-on type; white | www.wago.com/2009-145 |
|  | Nr. articol: 2009-145/000-002 Mini-WSB Inline; for Smart Printer; 1700 pieces on roll; stretchable 5 - 5.2 mm; plain; snap-on type; yellow | www.wago.com/2009-145/000-002 |
|  | Nr. articol: 2009-145/000-005 Mini-WSB Inline; for Smart Printer; 1700 pieces on roll; stretchable 5 - 5.2 mm; plain; snap-on type; red | www.wago.com/2009-145/000-005 |
|  | Nr. articol: 2009-145/000-006 Mini-WSB Inline; for Smart Printer; 1700 pieces on roll; stretchable 5 - 5.2 mm; plain; snap-on type; blue | www.wago.com/2009-145/000-006 |
|  | Nr. articol: 2009-145/000-007 Mini-WSB Inline; for Smart Printer; 1700 pieces on roll; stretchable 5 - 5.2 mm; plain; snap-on type; gray | www.wago.com/2009-145/000-007 |

Supus modificărilor.

WAGO Kontakttechnik GmbH & Co. KG
/Representative Office Romania
Sos. Pipera-Tunari nr. 1/1
building 1, 2nd floor | 077190 Voluntari, Ilfov
Tel.: +40-(0)31 421 85 68 | Email: info-RO@wago.com















Aveți întrebări despre produsele noastre?
Vă stăm la dispoziție pentru preluarea apelului la +40 (0) 31 421 85 68.

| | | |
|--|--|--|
|  | Nr. articol: 2009-145/000-012 Mini-WSB Inline; for Smart Printer; 1700 pieces on roll; stretchable 5 - 5.2 mm; plain; snap-on type; orange | www.wago.com/2009-145/000-012 |
|  | Nr. articol: 2009-145/000-023 Mini-WSB Inline; for Smart Printer; 1700 pieces on roll; stretchable 5 - 5.2 mm; plain; snap-on type; green | www.wago.com/2009-145/000-023 |
|  | Nr. articol: 2009-145/000-024 Mini-WSB Inline; for Smart Printer; 1700 pieces on roll; stretchable 5 - 5.2 mm; plain; snap-on type; violet | www.wago.com/2009-145/000-024 |
|  | Nr. articol: 2009-191 Group marker carrier | www.wago.com/2009-191 |
|  | Nr. articol: 2009-192 Group marker carrier | www.wago.com/2009-192 |
|  | Nr. articol: 2009-193 Group marker carrier | www.wago.com/2009-193 |
|  | Nr. articol: 2009-198 Adaptor | www.wago.com/2009-198 |
|  | Nr. articol: 248-501 Miniature WSB Quick marking system; plain; Marker width 5 mm; 10 strips with 10 markers per card | www.wago.com/248-501 |
|  | Nr. articol: 248-501/000-002 Mini-WSB marking card; as card; not stretchable; plain; snap-on type; yellow | www.wago.com/248-501/000-002 |
|  | Nr. articol: 248-501/000-005 Mini-WSB marking card; as card; not stretchable; plain; snap-on type; red | www.wago.com/248-501/000-005 |
|  | Nr. articol: 248-501/000-006 Mini-WSB marking card; as card; not stretchable; plain; snap-on type; blue | www.wago.com/248-501/000-006 |
|  | Nr. articol: 248-501/000-007 Mini-WSB marking card; as card; not stretchable; plain; snap-on type; gray | www.wago.com/248-501/000-007 |
|  | Nr. articol: 248-501/000-012 Mini-WSB marking card; as card; not stretchable; plain; snap-on type; orange | www.wago.com/248-501/000-012 |
|  | Nr. articol: 248-501/000-017 Mini-WSB marking card; as card; not stretchable; plain; snap-on type; light green | www.wago.com/248-501/000-017 |
|  | Nr. articol: 248-501/000-023 Mini-WSB marking card; as card; not stretchable; plain; snap-on type; green | www.wago.com/248-501/000-023 |

Supus modificărilor.

WAGO Kontakttechnik GmbH & Co. KG
/Representative Office Romania
Sos. Pipera-Tunari nr. 1/1
building 1, 2nd floor | 077190 Voluntari, Ilfov
Tel.: +40-(0)31 421 85 68 | Email: info-RO@wago.com

Aveți întrebări despre produsele noastre?
Vă stăm la dispoziție pentru preluarea apelului la +40 (0) 31 421 85 68.

| | | |
|--|--|--|
|  | Nr. articol: 248-501/000-024 Mini-WSB marking card; as card; not stretchable; plain; snap-on type; violet | www.wago.com/248-501/000-024 |
|  | Nr. articol: 793-501 WMB marking card; as card; not stretchable; plain; snap-on type; white | www.wago.com/793-501 |
|  | Nr. articol: 793-501/000-002 WMB marking card; as card; not stretchable; plain; snap-on type; yellow | www.wago.com/793-501/000-002 |
|  | Nr. articol: 793-501/000-005 WMB marking card; as card; not stretchable; plain; snap-on type; red | www.wago.com/793-501/000-005 |
|  | Nr. articol: 793-501/000-006 WMB marking card; as card; not stretchable; plain; snap-on type; blue | www.wago.com/793-501/000-006 |
|  | Nr. articol: 793-501/000-007 WMB marking card; as card; not stretchable; plain; snap-on type; gray | www.wago.com/793-501/000-007 |
|  | Nr. articol: 793-501/000-012 WMB marking card; as card; not stretchable; plain; snap-on type; orange | www.wago.com/793-501/000-012 |
|  | Nr. articol: 793-501/000-017 WMB marking card; as card; not stretchable; plain; snap-on type; light green | www.wago.com/793-501/000-017 |
|  | Nr. articol: 793-501/000-023 WMB marking card; as card; not stretchable; plain; snap-on type; green | www.wago.com/793-501/000-023 |
|  | Nr. articol: 793-501/000-024 WMB marking card; as card; not stretchable; plain; snap-on type; violet | www.wago.com/793-501/000-024 |
|  | Nr. articol: 793-5501 WMB marking card; as card; for terminal block width 5 - 17.5 mm; stretchable 5 - 5.2 mm; plain; snap-on type; white | www.wago.com/793-5501 |
|  | Nr. articol: 793-5501/000-002 WMB marking card; as card; for terminal block width 5 - 17.5 mm; stretchable 5 - 5.2 mm; plain; snap-on type; yellow | www.wago.com/793-5501/000-002 |
|  | Nr. articol: 793-5501/000-005 WMB marking card; as card; for terminal block width 5 - 17.5 mm; stretchable 5 - 5.2 mm; plain; snap-on type; red | www.wago.com/793-5501/000-005 |
|  | Nr. articol: 793-5501/000-006 WMB marking card; as card; for terminal block width 5 - 17.5 mm; stretchable 5 - 5.2 mm; plain; snap- | www.wago.com/793-5501/000-006 |

Supus modificărilor.

on type; blue



Nr. articol: 793-5501/000-007

WMB marking card; as card; for terminal block width 5 - 17.5 mm; stretchable 5 - 5.2 mm; plain; snap-on type; gray

www.wago.com/793-5501/000-007



Nr. articol: 793-5501/000-012

WMB marking card; as card; for terminal block width 5 - 17.5 mm; stretchable 5 - 5.2 mm; plain; snap-on type; orange

www.wago.com/793-5501/000-012



Nr. articol: 793-5501/000-014

WMB marking card; as card; for terminal block width 5 - 17.5 mm; stretchable 5 - 5.2 mm; plain; snap-on type; brown

www.wago.com/793-5501/000-014



Nr. articol: 793-5501/000-017

WMB marking card; as card; for terminal block width 5 - 17.5 mm; stretchable 5 - 5.2 mm; plain; snap-on type; green

www.wago.com/793-5501/000-017



Nr. articol: 793-5501/000-023

WMB marking card; as card; for terminal block width 5 - 17.5 mm; stretchable 5 - 5.2 mm; plain; snap-on type; light green

www.wago.com/793-5501/000-023



Nr. articol: 793-5501/000-024

WMB marking card; as card; for terminal block width 5 - 17.5 mm; stretchable 5 - 5.2 mm; plain; snap-on type; violet

www.wago.com/793-5501/000-024

Jumper



Nr. articol: 2002-400

Adjacent jumper for continuous commoning; insulated; 2-way; Nominal current 25 A; light gray

www.wago.com/2002-400



Nr. articol: 2002-402

Push-in type jumper bar; insulated; 2-way; Nominal current 25 A; light gray

www.wago.com/2002-402



Nr. articol: 2002-402/000-005

Push-in type jumper bar; insulated; 2-way; Nominal current 25 A; red

www.wago.com/2002-402/000-005



Nr. articol: 2002-402/000-006

Push-in type jumper bar; insulated; 2-way; Nominal current 25 A; blue

www.wago.com/2002-402/000-006



Nr. articol: 2002-403

Push-in type jumper bar; insulated; 3-way; Nominal current 25 A; light gray

www.wago.com/2002-403



Nr. articol: 2002-403/000-005

Push-in type jumper bar; insulated; 3-way; Nominal current 25 A; red

www.wago.com/2002-403/000-005



Nr. articol: 2002-403/000-006

Push-in type jumper bar; insulated; 3-way; Nominal current 25 A; blue

www.wago.com/2002-403/000-006

Nr. articol: 2002-404

Push-in type jumper bar; insulated; 4-way; Nominal current 25 A; light gray

www.wago.com/2002-404

Supus modificărilor.

**Nr. articol:** 2002-404/000-005

Push-in type jumper bar; insulated; 4-way; Nominal current 25 A; red

www.wago.com/2002-404/000-005**Nr. articol:** 2002-404/000-006

Push-in type jumper bar; insulated; 4-way; Nominal current 25 A; blue

www.wago.com/2002-404/000-006**Nr. articol:** 2002-405

Push-in type jumper bar; insulated; 5-way; Nominal current 25 A; light gray

www.wago.com/2002-405**Nr. articol:** 2002-405/000-005

Push-in type jumper bar; insulated; 5-way; Nominal current 25 A; red

www.wago.com/2002-405/000-005**Nr. articol:** 2002-405/000-006

Push-in type jumper bar; insulated; 5-way; Nominal current 25 A; blue

www.wago.com/2002-405/000-006**Nr. articol:** 2002-405/011-000

Star point jumper; insulated; 3-way (1-3-5); IN = IN terminal block; light gray

www.wago.com/2002-405/011-000**Nr. articol:** 2002-406

Push-in type jumper bar; insulated; 6-way; Nominal current 25 A; light gray

www.wago.com/2002-406**Nr. articol:** 2002-406/000-005

Push-in type jumper bar; insulated; 6-way; Nominal current 25 A; red

www.wago.com/2002-406/000-005**Nr. articol:** 2002-406/000-006

Push-in type jumper bar; insulated; 6-way; Nominal current 25 A; blue

www.wago.com/2002-406/000-006**Nr. articol:** 2002-406/020-000

Delta jumper; insulated; 1-2 3-4 5-6; IN = IN terminal block; light gray

www.wago.com/2002-406/020-000**Nr. articol:** 2002-407

Push-in type jumper bar; insulated; 7-way; Nominal current 25 A; light gray

www.wago.com/2002-407**Nr. articol:** 2002-407/000-005















Push-in type jumper bar; insulated; 7-way; Nominal current 25 A; red

www.wago.com/2002-407/000-005**Nr. articol:** 2002-407/000-006















Push-in type jumper bar; insulated; 7-way; Nominal current 25 A; blue

www.wago.com/2002-407/000-006

Supus modificărilor.

| | | |
|--|--|--|
|  | Nr. articol: 2002-408 Push-in type jumper bar; insulated; 8-way; Nominal current 25 A; light gray | www.wago.com/2002-408 |
|  | Nr. articol: 2002-408/000-005 Push-in type jumper bar; insulated; 8-way; Nominal current 25 A; red | www.wago.com/2002-408/000-005 |
|  | Nr. articol: 2002-408/000-006 Push-in type jumper bar; insulated; 8-way; Nominal current 25 A; blue | www.wago.com/2002-408/000-006 |
|  | Nr. articol: 2002-409 Push-in type jumper bar; insulated; 9-way; Nominal current 25 A; light gray | www.wago.com/2002-409 |
|  | Nr. articol: 2002-409/000-005 Push-in type jumper bar; insulated; 9-way; Nominal current 25 A; red | www.wago.com/2002-409/000-005 |
|  | Nr. articol: 2002-409/000-006 Push-in type jumper bar; insulated; 9-way; Nominal current 25 A; blue | www.wago.com/2002-409/000-006 |
|  | Nr. articol: 2002-410 Push-in type jumper bar; insulated; 10-way; Nominal current 25 A; light gray | www.wago.com/2002-410 |
|  | Nr. articol: 2002-410/000-005 Push-in type jumper bar; insulated; 10-way; Nominal current 25 A; red | www.wago.com/2002-410/000-005 |
|  | Nr. articol: 2002-410/000-006 Push-in type jumper bar; insulated; 10-way; Nominal current 25 A; blue | www.wago.com/2002-410/000-006 |
|  | Nr. articol: 2002-423 Adjacent jumper for continuous commoning; insulated; from 1 to 3; Nominal current 25 A; light gray | www.wago.com/2002-423 |
|  | Nr. articol: 2002-423/000-005 Adjacent jumper for continuous commoning; insulated; from 1 to 3; Nominal current 25 A; red | www.wago.com/2002-423/000-005 |
|  | Nr. articol: 2002-423/000-006 Adjacent jumper for continuous commoning; insulated; from 1 to 3; Nominal current 25 A; blue | www.wago.com/2002-423/000-006 |
|  | Nr. articol: 2002-433 Push-in type jumper bar; insulated; from 1 to 3; Nominal current 25 A; light gray | www.wago.com/2002-433 |
|  | Nr. articol: 2002-434 Push-in type jumper bar; insulated; from 1 to 4; Nominal current 25 A; light gray | www.wago.com/2002-434 |
|  | Nr. articol: 2002-435 Push-in type jumper bar; insulated; from 1 to 5; Nominal current 25 A; light gray | www.wago.com/2002-435 |











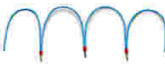

Supus modificărilor.

| | | |
|--|--|--|
|  | Nr. articol: 2002-436 Push-in type jumper bar; insulated; from 1 to 6; Nominal current 25 A; light gray | www.wago.com/2002-436 |
|  | Nr. articol: 2002-437 Push-in type jumper bar; insulated; from 1 to 7; Nominal current 25 A; light gray | www.wago.com/2002-437 |
|  | Nr. articol: 2002-438 Push-in type jumper bar; insulated; from 1 to 8; Nominal current 25 A; light gray | www.wago.com/2002-438 |
|  | Nr. articol: 2002-439 Push-in type jumper bar; insulated; from 1 to 9; Nominal current 25 A; light gray | www.wago.com/2002-439 |
|  | Nr. articol: 2002-440 Push-in type jumper bar; insulated; from 1 to 10; Nominal current 25 A; light gray | www.wago.com/2002-440 |
|  | Nr. articol: 2002-472 Staggered jumper; insulated; 2-way; Nominal current 25 A; suitable for 2002 and 2003 Series rail-mounted terminal blocks; light gray | www.wago.com/2002-472 |
|  | Nr. articol: 2002-473 Staggered jumper; insulated; 3-way; Nominal current 25 A; suitable for 2002 and 2003 Series rail-mounted terminal blocks; light gray | www.wago.com/2002-473 |
| | Nr. articol: 2002-473/011-000 Ready-made staggered jumper; insulated; 2-way (1-3); Nominal current 25 A; with contact lugs broken off at the factory and circuit marking; light gray | www.wago.com/2002-473/011-000 |
|  | Nr. articol: 2002-474 Staggered jumper; insulated; 4-way; Nominal current 25 A; suitable for 2002 and 2003 Series rail-mounted terminal blocks; light gray | www.wago.com/2002-474 |
|  | Nr. articol: 2002-475 Staggered jumper; insulated; 5-way; Nominal current 25 A; suitable for 2002 and 2003 Series rail-mounted terminal blocks; light gray | www.wago.com/2002-475 |
| | Nr. articol: 2002-475/011-000 Ready-made staggered jumper; insulated; 3-way (1-3-5); Nominal current 25 A; with contact lugs broken off at the factory and circuit marking; light gray | www.wago.com/2002-475/011-000 |
|  | Nr. articol: 2002-476 Staggered jumper; insulated; 6-way; Nominal current 25 A; suitable for 2002 and 2003 Series rail-mounted terminal blocks; light gray | www.wago.com/2002-476 |
|  | Nr. articol: 2002-477 Staggered jumper; insulated; 7-way; Nominal current 25 A; suitable for 2002 and 2003 Series rail-mounted terminal blocks; light gray | www.wago.com/2002-477 |
|  | Nr. articol: 2002-477/011-000 Ready-made staggered jumper; insulated; 1-3-5-7; Nominal current 25 A; with contact lugs broken off at the factory and circuit marking; light gray | www.wago.com/2002-477/011-000 |
|  | Nr. articol: 2002-478 Staggered jumper; insulated; 8-way; Nominal current 25 A; suitable for 2002 and 2003 Series rail-mounted terminal blocks; light gray | www.wago.com/2002-478 |
|  | Nr. articol: 2002-479 Staggered jumper; insulated; 9-way; Nominal current 25 A; suitable for 2002 and 2003 Series rail-mounted terminal blocks; light gray | www.wago.com/2002-479 |

Supus modificărilor.

WAGO Kontakttechnik GmbH & Co. KG
/Representative Office Romania
Sos. Pipera-Tunari nr. 1/1
building 1, 2nd floor | 077190 Voluntari, Ilfov
Tel.: +40-(0)31 421 85 68 | Email: info-RO@wago.com















Aveți întrebări despre produsele noastre?
Vă stăm la dispoziție pentru preluarea apelului la +40 (0) 31 421 85 68.

| | | |
|--|---|--|
| | Nr. articol: 2002-479/011-000 Ready-made staggered jumper; insulated; 1-3-5-7-9; Nominal current 25 A; with contact lugs broken off at the factory and circuit marking; light gray | www.wago.com/2002-479/011-000 |
|  | Nr. articol: 2002-480 Staggered jumper; insulated; 10-way; Nominal current 25 A; suitable for 2002 and 2003 Series rail-mounted terminal blocks; light gray | www.wago.com/2002-480 |
|  | Nr. articol: 2002-481 Staggered jumper; insulated; 11-way; Nominal current 25 A; suitable for 2002 and 2003 Series rail-mounted terminal blocks; light gray | www.wago.com/2002-481 |
| | Nr. articol: 2002-481/011-000 Ready-made staggered jumper; insulated; 1-3-5-7-9-11; Nominal current 25 A; with contact lugs broken off at the factory and circuit marking; light gray | www.wago.com/2002-481/011-000 |
|  | Nr. articol: 2002-482 Staggered jumper; insulated; 12-way; Nominal current 25 A; suitable for 2002 and 2003 Series rail-mounted terminal blocks; light gray | www.wago.com/2002-482 |
|  | Nr. articol: 210-103 Wire commoning chain; insulated; 50 connections; black | www.wago.com/210-103 |
|  | Nr. articol: 210-123 Wire commoning chain; insulated; 50 connections | www.wago.com/210-123 |
| tools | | |
|  | Nr. articol: 210-658 Operating tool; Blade: 3.5 x 0.5 mm; with a partially insulated shaft; angled; short | www.wago.com/210-658 |
|  | Nr. articol: 210-720 Operating tool; Blade: 3.5 x 0.5 mm; with a partially insulated shaft | www.wago.com/210-720 |
| ferrule | | |
|  | Nr. articol: 216-241 Ferrule; Sleeve for 0.5 mm ² / 20 AWG; insulated; electro-tin plated; electrolytic copper; gastight crimped; acc. to DIN 46228, Part 4/09.90; white | www.wago.com/216-241 |
|  | Nr. articol: 216-242 Ferrule; Sleeve for 0.75 mm ² / 18 AWG; insulated; electro-tin plated; electrolytic copper; gastight crimped; acc. to DIN 46228, Part 4/09.90; gray | www.wago.com/216-242 |
|  | Nr. articol: 216-243 Ferrule; Sleeve for 1 mm ² / AWG 18; insulated; electro-tin plated; electrolytic copper; gastight crimped; acc. to DIN 46228, Part 4/09.90; red | www.wago.com/216-243 |
|  | Nr. articol: 216-244 Ferrule; Sleeve for 1.5 mm ² / AWG 16; insulated; electro-tin plated; electrolytic copper; gastight crimped; acc. to DIN 46228, Part 4/09.90; black | www.wago.com/216-244 |
|  | Nr. articol: 216-246 Ferrule; Sleeve for 2.5 mm ² / AWG 14; insulated; electro-tin plated; electrolytic copper; gastight crimped; acc. to DIN 46228, Part 4/09.90; blue | www.wago.com/216-246 |
|  | Nr. articol: 216-262 Ferrule; Sleeve for 0.75 mm ² / 18 AWG; insulated; electro-tin plated; electrolytic copper; gastight crimped; acc. to DIN 46228, Part 4/09.90; gray | www.wago.com/216-262 |
| | Nr. articol: 216-263 | |









Supus modificărilor.

WAGO Kontakttechnik GmbH & Co. KG
/Representative Office Romania
Sos. Pipera-Tunari nr. 1/1
building 1, 2nd floor | 077190 Voluntari, Ilfov
Tel.: +40-(0)31 421 85 68 | Email: info-RO@wago.com

Aveți întrebări despre produsele noastre?
Vă stăm la dispoziție pentru preluarea apelului la +40 (0) 31 421 85 68.

| | | |
|--|---|--|
|  | Ferrule; Sleeve for 1 mm ² / AWG 18; insulated; electro-tin plated; electrolytic copper; gastight crimped; acc. to DIN 46228, Part 4/09.90; red | www.wago.com/216-263 |
|  | Nr. articol: 216-264 Ferrule; Sleeve for 1.5 mm ² / AWG 16; insulated; electro-tin plated; electrolytic copper; gastight crimped; acc. to DIN 46228, Part 4/09.90; black | www.wago.com/216-264 |
|  | Nr. articol: 216-266 Ferrule; Sleeve for 2.5 mm ² / AWG 14; insulated; electro-tin plated; electrolytic copper; gastight crimped; acc. to DIN 46228, Part 4/09.90; blue | www.wago.com/216-266 |
| Insulation stop | | |
|  | Nr. articol: 2002-171 Insulation stop; 0.25 - 0.5 mm ² ; 5 pieces/strip; light gray | www.wago.com/2002-171 |
|  | Nr. articol: 2002-172 Insulation stop; 0.75 - 1 mm ² ; 5 pieces/strip; dark gray | www.wago.com/2002-172 |
| End plate | | |
|  | Nr. articol: 2002-2991 End and intermediate plate; 1 mm thick; gray | www.wago.com/2002-2991 |
|  | Nr. articol: 2002-2992 End and intermediate plate; 1 mm thick; orange | www.wago.com/2002-2992 |
| Push-In type wire jumper | | |
|  | Nr. articol: 2009-412 Push-in type wire jumper; insulated; wire length 60 mm; Conductor cross section 1.5 mm ² ; suitable for 2001, 2002, 2003 and 2022 Series rail-mounted terminal blocks; black | www.wago.com/2009-412 |
|  | Nr. articol: 2009-414 Push-in type wire jumper; insulated; wire length 110 mm; Conductor cross section 1.5 mm ² ; suitable for 2001, 2002, 2003 and 2022 Series rail-mounted terminal blocks; black | www.wago.com/2009-414 |
|  | Nr. articol: 2009-414/000-005 Push-in type wire jumper; insulated; wire length 110 mm; Conductor cross section 1.5 mm ² ; suitable for 2001, 2002, 2003 and 2022 Series rail-mounted terminal blocks; red | www.wago.com/2009-414/000-005 |
|  | Nr. articol: 2009-414/000-006 Push-in type wire jumper; insulated; wire length 110 mm; Conductor cross section 1.5 mm ² ; suitable for 2001, 2002, 2003 and 2022 Series rail-mounted terminal blocks; blue | www.wago.com/2009-414/000-006 |
|  | Nr. articol: 2009-416 Push-in type wire jumper; insulated; wire length 250 mm; Conductor cross section 1.5 mm ² ; suitable for 2001, 2002, 2003 and 2022 Series rail-mounted terminal blocks; black | www.wago.com/2009-416 |
| Carrier rail | | |
|  | Nr. articol: 210-112 Steel carrier rail; 35 x 7.5 mm; 1 mm thick; 2 m long; slotted; according to EN 60715; "Hole width 25 mm | www.wago.com/210-112 |
|  | Nr. articol: 210-113 Steel carrier rail; 35 x 7.5 mm; 1 mm thick; 2 m long; unslotted; according to EN 60715 | www.wago.com/210-113 |
|  | Nr. articol: 210-114 Steel carrier rail; 35 x 15 mm; 1.5 mm thick; 2 m long; unslotted; similar to EN 60715 | www.wago.com/210-114 |

Supus modificărilor.

| | | |
|---|---|--|
|  | Nr. articol: 210-115 Steel carrier rail; 35 x 7.5 mm; 1 mm thick; 2 m long; slotted; according to EN 60715; "Hole width 18 mm | www.wago.com/210-115 |
|  | Nr. articol: 210-118 Steel carrier rail; 35 x 15 mm; 2.3 mm thick; 2 m long; unslotted; according to EN 60715 | www.wago.com/210-118 |
|  | Nr. articol: 210-196 Aluminum carrier rail; 35 x 8.2 mm; 1.6 mm thick; 2 m long; unslotted; similar to EN 60715; silver-colored | www.wago.com/210-196 |
|  | Nr. articol: 210-197 Steel carrier rail; 35 x 15 mm; 1.5 mm thick; 2 m long; slotted; similar to EN 60715 | www.wago.com/210-197 |
|  | Nr. articol: 210-198 Copper carrier rail; 35 x 15 mm; 2.3 mm thick; 2 m long; unslotted; according to EN 60715; copper-colored | www.wago.com/210-198 |
|  | Nr. articol: 210-504 Steel carrier rail; 35 x 7.5 mm; 1 mm thick; 2 m long; slotted; galvanized; according to EN 60715 | www.wago.com/210-504 |
|  | Nr. articol: 210-505 Steel carrier rail; 35 x 7.5 mm; 1 mm thick; 2 m long; unslotted; galvanized; according to EN 60715 | www.wago.com/210-505 |
|  | Nr. articol: 210-506 Steel carrier rail; 35 x 15 mm; 1.5 mm thick; 2 m long; unslotted; galvanized; similar to EN 60715 | www.wago.com/210-506 |
|  | Nr. articol: 210-508 Steel carrier rail; 35 x 15 mm; 1.5 mm thick; 2 m long; slotted; galvanized; similar to EN 60715 | www.wago.com/210-508 |

Descărcări

Documentation

Additional Information

| | | | |
|------------------------|-------------|---------------|------------|
| Technical explanations | Apr 3, 2019 | pdf 2,1 MB | Descărcare |
|------------------------|-------------|---------------|------------|

CAD/CAE-Data

CAD data

| | | |
|------------------------|-----|------------|
| 2D/3D Models 2002-2972 | URL | Descărcare |
|------------------------|-----|------------|

CAE data

| | | |
|-----------------------------|-----|------------|
| EPLAN Data Portal 2002-2972 | URL | Descărcare |
|-----------------------------|-----|------------|

| | | |
|--------------------------|-----|------------|
| WSCAD Universe 2002-2972 | URL | Descărcare |
|--------------------------|-----|------------|

Supus modificărilor.

WAGO Kontakttechnik GmbH & Co. KG
/Representative Office Romania
Sos. Pipera-Tunari nr. 1/1
building 1, 2nd floor | 077190 Voluntari, Ilfov
Tel.: +40-(0)31 421 85 68 | Email: info-RO@wago.com

Aveți întrebări despre produsele noastre?
Vă stăm la dispoziție pentru preluarea apelului la +40 (0) 31 421 85 68.

Installation Notes

Conductor termination

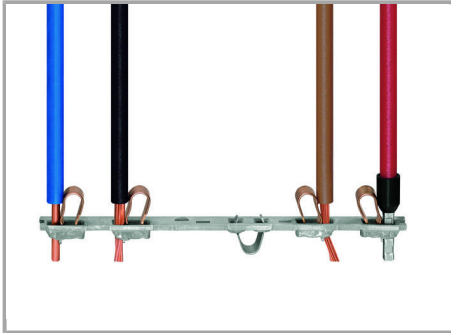

All conductor types at a glance

Testing

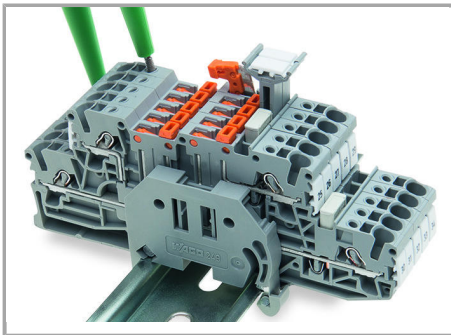

Testing with voltage tester.

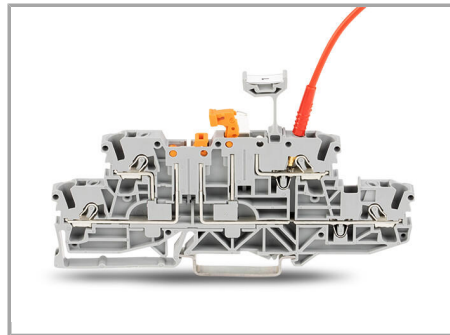

Double-deck, double-disconnect terminal block (2002-2951) with group marker carrier (2002-160) accommodated in a jumper contact slot and test plug (210-136)

Marking

Supus modificărilor.

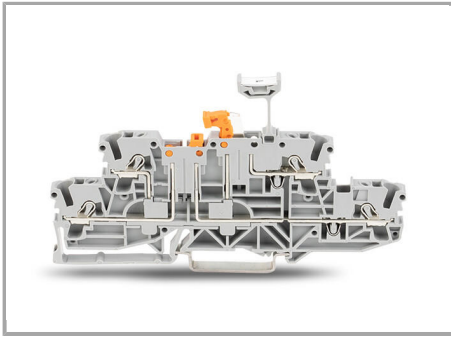

Double-deck, double-disconnect terminal block (2002-2951) with group marker carrier (2002-160) accommodated in jumper contact slot

Familie de produse

TOPJOB® S

TOPJOB® S: In various industrial applications and modern building installations, WAGO's wide and versatile range of rail-mount terminal blocks provides more than just reliable electrical connections.

[Afișare globală produse din familie.](#)

Supus modificărilor.