

## Fișă tehnică | Număr articol: 770-1681

h-distribution connector; 4-pole; Cod. B; 1 input; 2 outputs; outputs on one side; 2 locking levers; gray

[www.wago.com/770-1681](http://www.wago.com/770-1681)

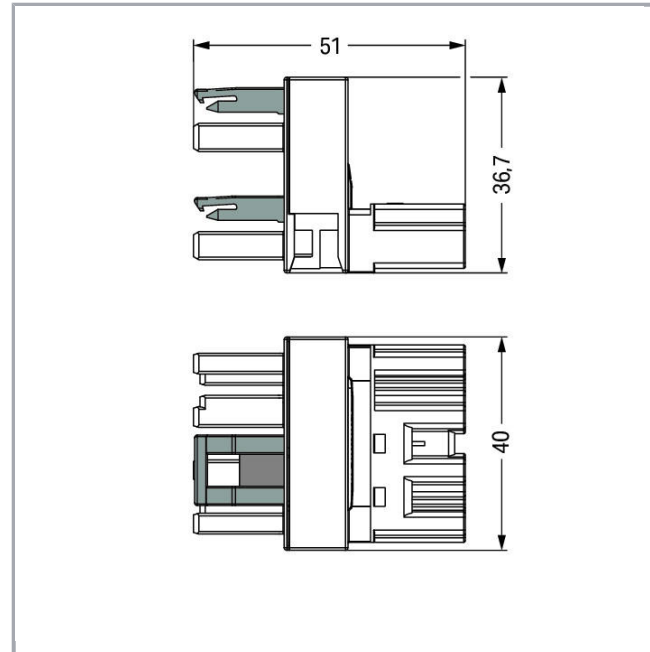
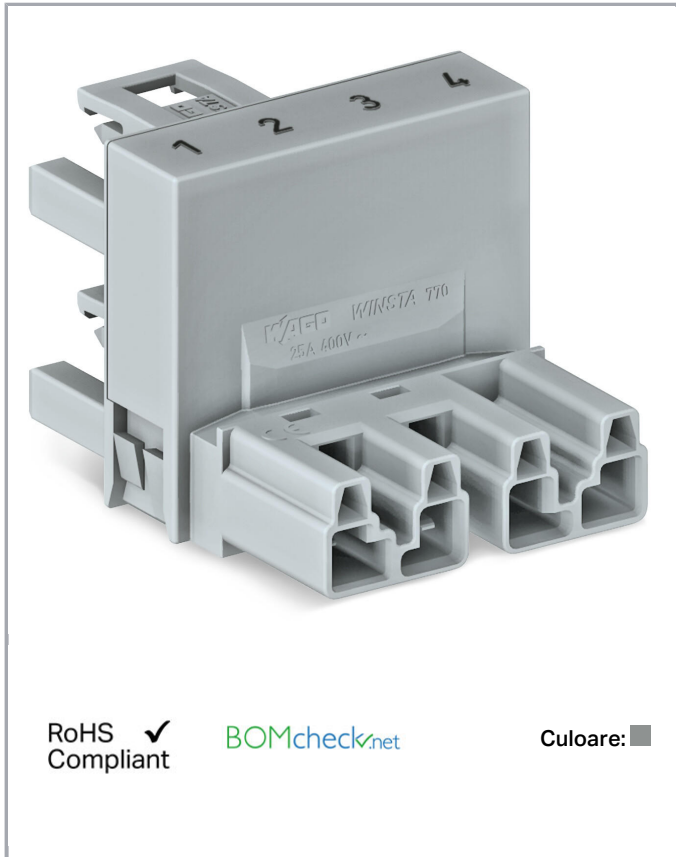

### Descriere articol

- Protected against mismatching and maintenance-free
- Additional variable coding is possible
- Components can be clearly printed on and color-coded to meet custom requirements

#### Note:

All connectors for mounted installations (snap-in versions for lighting fixtures or devices, all types of PCB and distribution connectors) are factory-equipped with locking levers to ensure plugs and sockets are securely locked. Additional locking levers are only required for flying leads (plug /socket).

#### Note on mismatching protection:

All WINSTA<sup>®</sup> components are 100% protected against mismatching when:

- a.) plugging different numbers of poles
- b.) plugging while rotated 180

Supus modificărilor.

WAGO Kontakttechnik GmbH & Co. KG  
/Representative Office Romania  
Sos. Pipera-Tunari nr. 1/1  
building 1, 2nd floor | 077190 Voluntari, Ilfov  
Tel.: +40-(0)31 421 85 68 | Email: info-RO@wago.com

Aveți întrebări despre produsele noastre?  
Vă stăm la dispoziție pentru preluarea apelului la +40 (0) 31 421 85 68.



c.) plugging while laterally staggered

d.) plugging one pole

**Safety information 1:**

Application note for the U.S. market (USR): Some versions may also be used for current interruption in accordance with the UL certificate in select applications with currents below 16 A and voltages up to 600 V. For further information, please contact your local sales office.

**Date****Electrical data**

Note on Contact Resistance	approx. 1 mΩ of contact resistance approx. 0.25 mΩ contact transition plug/socket
----------------------------	---

**Ratings per IEC/EN 60664-1**

Ratings per	IEC/EN 60664-1
Nominal voltage (III/3)	400 V
Rated surge voltage (III/3)	6 kV
Rated current	25 A
Legend (ratings)	(III / 3) ≙ Overvoltage category III / Pollution degree 3

**Approvals per UL 1977**

Rated voltage UL 1977	600 V
Rated current UL 1977	23 A

**Connection data**

Pole No.	4
Total number of potentials	4

**Geometrical Data**

Pin spacing	10 mm / 0.394 inch
Width	40 mm / 1.575 inch
Height	36,7 mm / 1.445 inch
Depth	51 mm / 2.008 inch

**Mechanical data**

Coding	B
Mating force of a plug-in connection	approx. 20 ... 70 N (depending on pole number)
Retention force of a plug-in connection	When locked: > 80 N
Unmating force of a plug-in connection	when unlocked: approx. 20 ... 70 N (depending on pole number)

Supus modificărilor.

WAGO Kontakttechnik GmbH & Co. KG  
 /Representative Office Romania  
 Sos. Pipera-Tunari nr. 1/1  
 building 1, 2nd floor | 077190 Voluntari, Ilfov  
 Tel.: +40-(0)31 421 85 68 | Email: info-RO@wago.com

Aveți întrebări despre produsele noastre?  
 Vă stăm la dispoziție pentru preluarea apelului la +40 (0) 31 421 85 68.



Number of mating cycles	200, without resistive load 100, with resistive load $I_N = 25$ A, tested (4 mm <sup>2</sup> /AWG 12)
Distributor type	h-distribution connector (unidirectional)
Marking	1 2 3 4
Protection type	IP20
Note on protection type	Only when mated (these compact connectors are not designed for use in open, easily accessible areas).
Potential marking	1 2 3 4

### Plug connection

Contact type (pluggable connector)	Socket/plug
Mismating protection	Yes
Locking of plug-in connection	locking lever
Locking lever	yes

### Material Data

Color	gray
Insulation material	Polyamide 66 (PA 66)
Contact material	Copper or copper alloy (surface-treated)
Fire load	0,544 MJ
Weight	32 g

### Environmental Requirements

Processing temperature	-5 ... +40 °C
Continuous operating temperature	-35 ... +85 °C
Note on continuous operating temperature	Insulating parts for temperatures $\leq 105$ °C

### Commercial data

Product Group	20 (WINSTA)
Packaging type	BOX
Country of origin	DE
GTIN	4050821687740
Customs tariff number	85366990990

### Aprobări / certificate

#### UL-Approvals





Supus modificărilor.

WAGO Kontakttechnik GmbH & Co. KG  
 /Representative Office Romania  
 Sos. Pipera-Tunari nr. 1/1  
 building 1, 2nd floor | 077190 Voluntari, Ilfov  
 Tel.: +40-(0)31 421 85 68 | Email: info-RO@wago.com

Aveți întrebări despre produsele noastre?  
 Vă stăm la dispoziție pentru preluarea apelului la +40 (0) 31 421 85 68.

Emblemă	Aprobare	Text de aprobare suplimentar	Nume certificat
	cURus Underwriters Laboratories Inc.	UL 1977	E45171 Sec. 9

## Counterpart

	<b>Nr. articol</b> 770-254 Plug; 4-pole; Cod. B; 4,00 mm <sup>2</sup> ; gray	<a href="http://www.wago.com/770-254">www.wago.com/770-254</a>
	<b>Nr. articol</b> 770-244 Socket; 4-pole; Cod. B; 4,00 mm <sup>2</sup> ; gray	<a href="http://www.wago.com/770-244">www.wago.com/770-244</a>
	<b>Nr. articol</b> 771-9994/005-103 pre-assembled interconnecting cable; Socket/plug; 4-pole; Cod. B; Control cable 4 x 1.0 mm <sup>2</sup> ; 1 m; 1,00 mm <sup>2</sup> ; gray	<a href="http://www.wago.com/771-9994/005-103">www.wago.com/771-9994/005-103</a>
	<b>Nr. articol</b> 771-9994/105-103 pre-assembled connecting cable; Eca; Socket/open-ended; 4-pole; Cod. B; Control cable 4 x 1.0 mm <sup>2</sup> ; 1 m; 1,00 mm <sup>2</sup> ; gray	<a href="http://www.wago.com/771-9994/105-103">www.wago.com/771-9994/105-103</a>
	<b>Nr. articol</b> 771-9994/205-103 pre-assembled connecting cable; Eca; Plug/open-ended; 4-pole; Cod. B; Control cable 4 x 1.0 mm <sup>2</sup> ; 1 m; 1,00 mm <sup>2</sup> ; gray	<a href="http://www.wago.com/771-9994/205-103">www.wago.com/771-9994/205-103</a>

## Descărcări

### CAD/CAE-Data

#### CAD data

2D/3D Models 770-1681	URL	Descărcare
-----------------------	-----	------------

#### CAE data

WSCAD Universe 770-1681	URL	Descărcare
-------------------------	-----	------------

## Installation Notes

### Installation

Supus modificărilor.

WAGO Kontakttechnik GmbH & Co. KG  
/Representative Office Romania  
Sos. Pipera-Tunari nr. 1/1  
building 1, 2nd floor | 077190 Voluntari, Ilfov  
Tel.: +40-(0)31 421 85 68 | Email: info-RO@wago.com

Aveți întrebări despre produsele noastre?  
Vă stăm la dispoziție pentru preluarea apelului la +40 (0) 31 421 85 68.

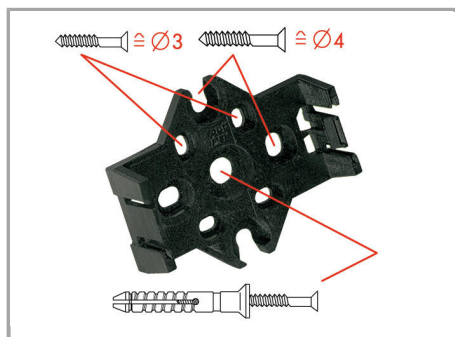

The mounting plate for distribution connectors can be mounted using commercially available screws or nail-drive anchors.



The distribution connectors are latched when mounted on the mounting plate.



To release the distribution connector, unlock the latch using a screwdriver.

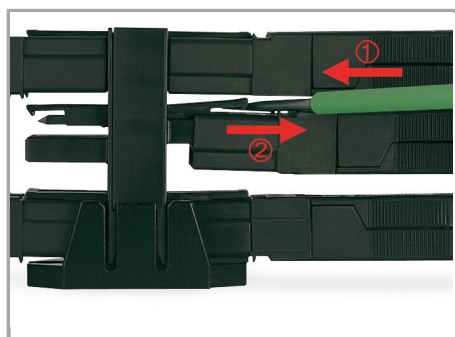

All distributor connections are locked and protected against accidental disconnection directly after mating. Locking of any connection is released using a screwdriver, even if all connections are in use.

## Familie de produse

**<i>WINSTA</i>® MIDI special**  
Afișare globală produse din familie.

Supus modificărilor.