

Fișă tehnică | Număr articol: 891-8994/105-103

pre-assembled connecting cable; Eca; Socket/open-ended; 4-pole; Cod. B;
Control cable 4 x 1.0 mm²; 1 m; 1,00 mm²; gray

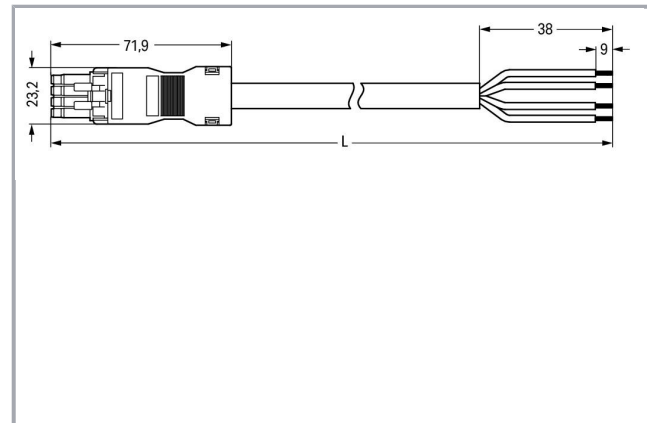

www.wago.com/891-8994/105-103

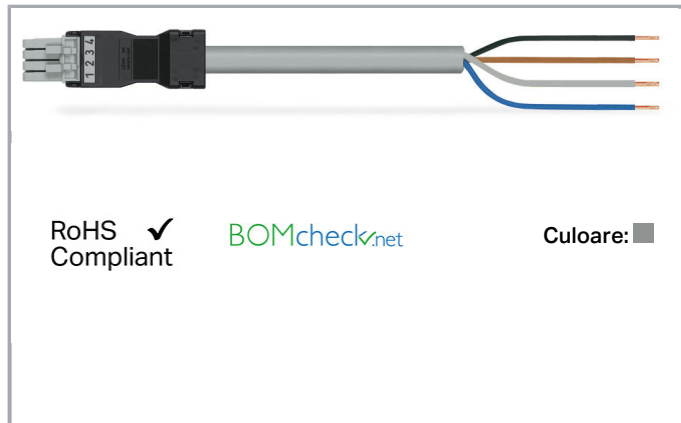

Descriere articol

- Protected against mismatching and maintenance-free
- Compact design with 4.4 mm pole spacing
- Components can be clearly printed on and color-coded to meet custom requirements

Note:

Cables with a different fire class can be found in the eShop.

Note on mismatching protection:

All WINSTA[®] components are 100% protected against mismatching when:

- plugging different numbers of poles
- plugging while rotated 180
- plugging while laterally staggered
- plugging one pole

Safety information 1:

Application note for the U.S. market (USR): Some versions may also be used for current interruption in accordance with the UL certificate in select applications with currents below 5 A and voltages up to 600 V. For further information, please contact your local sales office.

Date

Electrical data

Note on Contact Resistance

approx. 1 mΩ of contact resistance approx. 0.25 mΩ contact transition plug/socket

Supus modificărilor.

WAGO Kontakttechnik GmbH & Co. KG
/Representative Office Romania
Sos. Pipera-Tunari nr. 1/1
building 1, 2nd floor | 077190 Voluntari, Ilfov
Tel.: +40-(0)31 421 85 68 | Email: info-RO@wago.com

Aveți întrebări despre produsele noastre?
Vă stăm la dispoziție pentru preluarea apelului la +40 (0) 31 421 85 68.



Ratings per IEC/EN 60664-1

Ratings per	IEC/EN 60664-1
Nominal voltage (III/3)	400 V
Rated surge voltage (III/3)	6 kV
Rated current	10 A
Legend (ratings)	(III / 3) $\hat{=}$ Overvoltage category III / Pollution degree 3

Approvals per UL 1977

Rated voltage UL 1977	600 V
Rated current UL 1977	12 A

Connection data

Strip length	9 mm / 0.35 inch
Pole No.	4
Total number of potentials	4
Conductor preparation	tip-bonded
Sheathed cable diameter	7,1 ... 9 mm
Wire cross-section	1 mm ²
Strip length (outer insulation)	38 mm
Connection type	Socket - Free end

Geometrical Data

Pin spacing	4,4 mm / 0.173 inch
Total length	1 m

Mechanical data

Coding	B
Mating force of a plug-in connection	approx. 20 ... 70 N (depending on pole number)
Retention force of a plug-in connection	when locked: > 80N
Unmating force of a plug-in connection	when unlocked: approx. 20 ... 70 N (depending on pole number)
Number of mating cycles	200, without resistive load 100, with resistive load $I_N = 16$ A, tested (1.5 mm ² /16 AWG)
Connection type	Socket - free end

Supus modificărilor.



Type of pre-assembled cable	Connecting cable
Cable type	Control line 4 x 1
Marking	1 2 3 4
Protection type	IP40
Potential marking	1 2 3 4

Plug connection

Mismating protection	Yes
Locking of plug-in connection	locking lever
Locking lever	retrofittable

Material Data

Color	gray
Insulation material	Polyamide 66 (PA 66)
Fire class per EN 50575	E _{ca}
Contact material	Copper or copper alloy (surface-treated)
Fire load	1,521 MJ
Connector color	gray
Printing color of mating face	black
Strain relief color	black
Printing color of strain relief	white
Sheathed cable color	gray
Printing color of sheathed cable	black
Sheath material	PVC
Weight	89,4 g

Environmental Requirements

Processing temperature	-5 ... +40 °C
Continuous operating temperature	-35 ... +85 °C
Note on continuous operating temperature	PVC cable for temperatures ≤ 70 °C (including halogen-free) Insulating parts for temperatures ≤ 105 °C

Commercial data

Packaging type	not packed
Country of origin	PL
GTIN	4050821295556

Supus modificărilor.









WAGO Kontakttechnik GmbH & Co. KG
/Representative Office Romania
Sos. Pipera-Tunari nr. 1/1
building 1, 2nd floor | 077190 Voluntari, Ilfov
Tel.: +40-(0)31 421 85 68 | Email: info-RO@wago.com

Aveți întrebări despre produsele noastre?
Vă stăm la dispoziție pentru preluarea apelului la +40 (0) 31 421 85 68.

Customs tariff number

85444290900

Counterpart

	Nr. articol 890-1631 T-distribution connector; 4-pole; Cod. B; 1 input; 2 outputs; 2 locking levers; gray	www.wago.com/890-1631
	Nr. articol 890-1681 h-distribution connector; 4-pole; Cod. B; 1 input; 2 outputs; outputs on one side; 2 locking levers; gray	www.wago.com/890-1681
	Nr. articol 890-1731 T-distribution connector; 4-pole; Cod. B; 1 input; 2 outputs; 3 locking levers; for flying leads; gray	www.wago.com/890-1731
	Nr. articol 890-1734 3-way distribution connector; 4-pole; Cod. B; 1 input; 3 outputs; gray	www.wago.com/890-1734
	Nr. articol 890-1781 h-distribution connector; 4-pole; Cod. B; 1 input; 2 outputs; outputs on one side; 3 locking levers; for flying leads; gray	www.wago.com/890-1781
	Nr. articol 890-254 Plug; 4-pole; 1,50 mm ² ; gray	www.wago.com/890-254
	Nr. articol 890-754 Snap-in plug; 4-pole; Cod. B; 1,50 mm ² ; gray	www.wago.com/890-754
	Nr. articol 890-854 Plug for PCBs; straight; 4-pole; Cod. B	www.wago.com/890-854
	Nr. articol 890-854/011-000 Plug for PCBs; angled; 4-pole; Cod. B; gray	www.wago.com/890-854/011-000

Descărcări

CAD/CAE-Data

CAE data

WSCAD Universe 891-8994/105-103

URL

Descărcare

Supus modificărilor.

WAGO Kontakttechnik GmbH & Co. KG
 /Representative Office Romania
 Sos. Pipera-Tunari nr. 1/1
 building 1, 2nd floor | 077190 Voluntari, Ilfov
 Tel.: +40-(0)31 421 85 68 | Email: info-RO@wago.com

Aveți întrebări despre produsele noastre?
 Vă stăm la dispoziție pentru preluarea apelului la +40 (0) 31 421 85 68.



Installation Notes

Familie de produse

WINSTA® MINI special

Afișare globală produse din familie.

Supus modificărilor.

WAGO Kontakttechnik GmbH & Co. KG
/Representative Office Romania
Sos. Pipera-Tunari nr. 1/1
building 1, 2nd floor | 077190 Voluntari, Ilfov
Tel.: +40-(0)31 421 85 68 | Email: info-RO@wago.com

Aveți întrebări despre produsele noastre?
Vă stăm la dispoziție pentru preluarea apelului la +40 (0) 31 421 85 68.