

Fișă tehnică | Număr articol: 745-307

PCB terminal block; 6 mm<sup>2</sup>; Pin spacing 7.5 mm; 7-pole; CAGE CLAMP®; commoning option; 6,00 mm<sup>2</sup>; gray

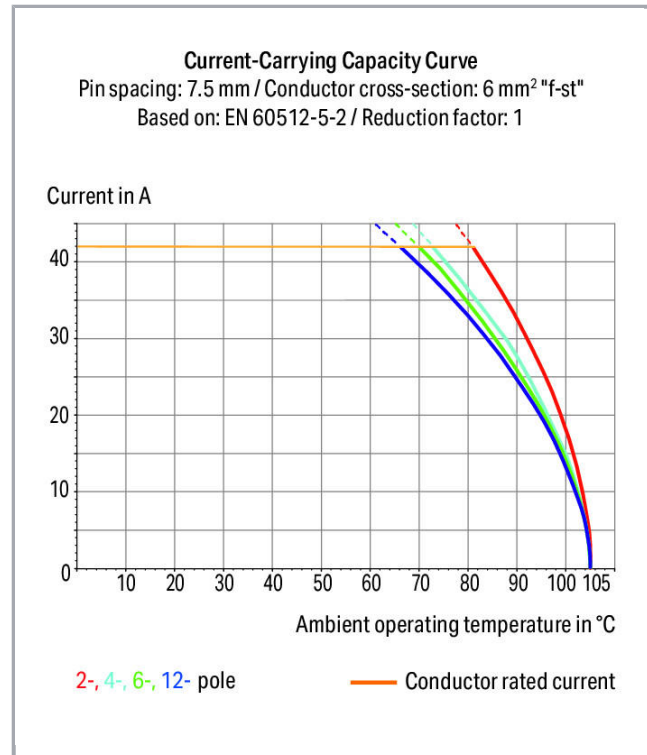

[www.wago.com/745-307](http://www.wago.com/745-307)

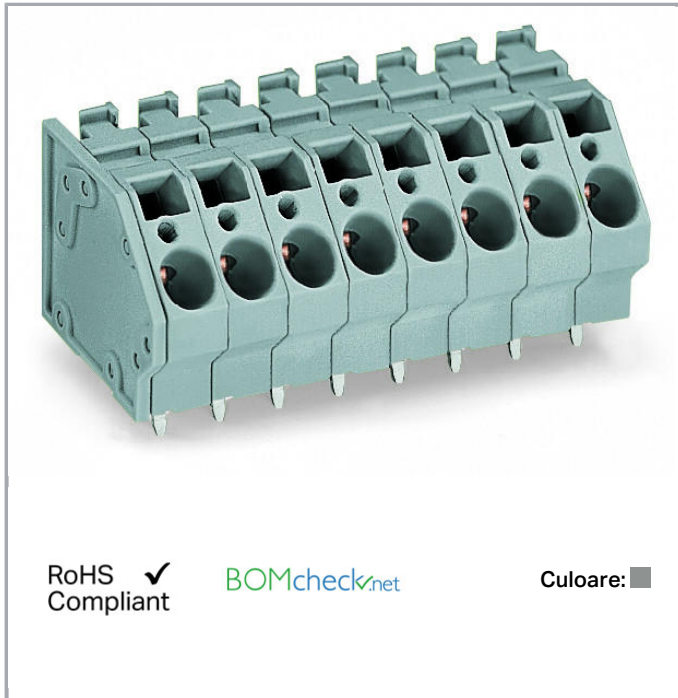

Supus modificărilor.

WAGO Kontakttechnik GmbH & Co. KG  
/Representative Office Romania  
Sos. Pipera-Tunari nr. 1/1  
building 1, 2nd floor | 077190 Voluntari, Ilfov  
Tel.: +40-(0)31 421 85 68 | Email: info-RO@wago.com

Aveți întrebări despre produsele noastre?  
Vă stăm la dispoziție pentru preluarea apelului la +40 (0) 31 421 85 68.

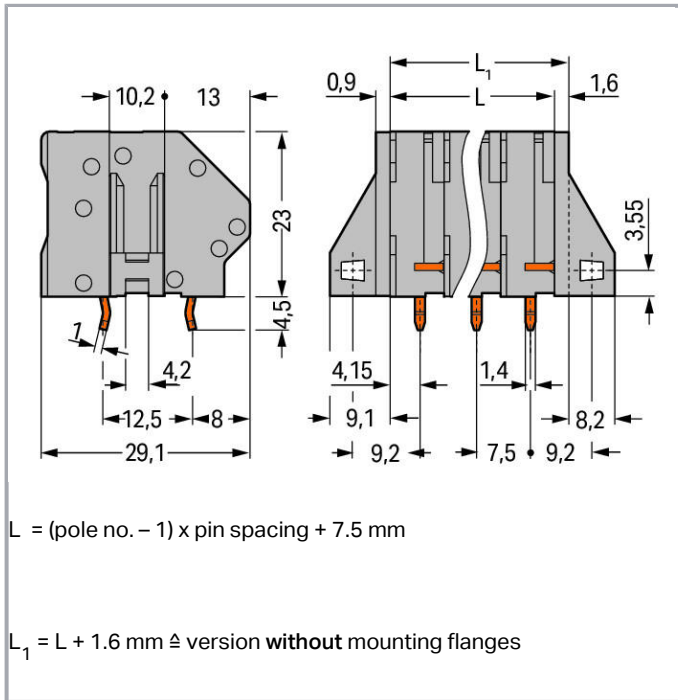

## Descriere articol

- PCB terminal strips with screwdriver-actuated CAGE CLAMP® connection
- Versions with Ex approval
- Common and distribute potentials via comb-style jumper bars
- Double solder pins for high mechanical stability
- Custom color combinations
- Integrated testing tap
- Marker slot for Mini-WSB markers

## Date

### Electrical data

### Ratings per IEC/EN 60664-1

Ratings per	IEC/EN 60664-1
Nominal voltage (III/3)	500 V
Rated surge voltage (III/3)	6 kV
Rated voltage (III/2)	630 V
Rated surge voltage (III/2)	6 kV
Nominal voltage (II/2)	1000 V

Supus modificărilor.

WAGO Kontakttechnik GmbH & Co. KG  
 /Representative Office Romania  
 Sos. Pipera-Tunari nr. 1/1  
 building 1, 2nd floor | 077190 Voluntari, Ilfov  
 Tel.: +40-(0)31 421 85 68 | Email: info-RO@wago.com

Aveți întrebări despre produsele noastre?  
 Vă stăm la dispoziție pentru preluarea apelului la +40 (0) 31 421 85 68.



Rated surge voltage (II/2)	6 kV
Rated current	41 A
Legend (ratings)	(III / 2) $\hat{=}$ Overvoltage category III / Pollution degree 2

### Approvals per UL 1059

Rated voltage UL (Use Group B)	300 V
Rated current UL (Use Group B)	30 A
Rated voltage UL (Use Group C)	150 V
Rated current UL (Use Group C)	30 A
Rated voltage UL (Use Group D)	300 V
Rated current UL (Use Group D)	10 A
Approvals per	UL 1059

### Approvals per CSA

Rated voltage CSA (Use Group B)	300 V
Rated current CSA (Use Group B)	30 A
Rated voltage CSA (Use Group C)	150 V
Rated current CSA (Use Group C)	30 A
Rated voltage CSA (Use Group D)	300 V
Rated current CSA (Use Group D)	10 A

### Connection data

Connection technology	CAGE CLAMP®
Actuation type	Operating tool
Solid conductor	0,2 ... 6 mm <sup>2</sup> / 24 ... 10 AWG
Fine-stranded conductor	0,2 ... 6 mm <sup>2</sup> / 24 ... 10 AWG
Fine-stranded conductor; with insulated ferrule	0,25 ... 4 mm <sup>2</sup>
Fine-stranded conductor; with uninsulated ferrule	0,25 ... 4 mm <sup>2</sup>
Strip length	11 ... 12 mm / 0.43 ... 0.47 inch
Conductor connection direction to PCB	45°
Pole No.	7
Total number of connection points	7
Total number of potentials	7
Number of connection types	1
Number of levels	1
Number of jumper slots	1

Supus modificărilor.

WAGO Kontakttechnik GmbH & Co. KG  
 /Representative Office Romania  
 Sos. Pipera-Tunari nr. 1/1  
 building 1, 2nd floor | 077190 Voluntari, Ilfov  
 Tel.: +40-(0)31 421 85 68 | Email: info-RO@wago.com

Aveți întrebări despre produsele noastre?  
 Vă stăm la dispoziție pentru preluarea apelului la +40 (0) 31 421 85 68.

## Geometrical Data

Pin spacing	7,5 mm / 0.295 inch
Width	54,1 mm / 2.13 inch
Height	27,5 mm / 1.083 inch
Height from the surface	23 mm / 0.906 inch
Depth	29,1 mm / 1.146 inch
Solder pin length	4,5 mm
Solder pin dimensions	1 x 1,4 mm
Drilled hole diameter with tolerance	1,8 <sup>(+0,1)</sup> mm

## PCB contact

PCB contact	THT
Solder pin arrangement	over the entire terminal strip (in-line)
Number of solder pins per potential	2

## Material Data

Color	gray
Material group	I
Insulation material	Polyamide 66 (PA 66)
Flammability class per UL94	V0
Clamping spring material	Chrome nickel spring steel (CrNi)
Contact material	Electrolytic copper (E <sub>Cu</sub> )
Contact plating	tin-plated
Fire load	0,532 MJ
Weight	34 g

## Environmental Requirements

Limit temperature range	-60 ... +105 °C
-------------------------	-----------------

## Commercial data

Product Group	4 (Printed Circuit)
Packaging type	BOX
Country of origin	PL
GTIN	4044918302227
Customs tariff number	85369010000



Supus modificărilor.

WAGO Kontakttechnik GmbH & Co. KG  
 /Representative Office Romania  
 Sos. Pipera-Tunari nr. 1/1  
 building 1, 2nd floor | 077190 Voluntari, Ilfov  
 Tel.: +40-(0)31 421 85 68 | Email: info-RO@wago.com

Aveți întrebări despre produsele noastre?  
 Vă stăm la dispoziție pentru preluarea apelului la +40 (0) 31 421 85 68.

## Aprobări / certificate

## Country specific Approvals

Emblemă	Aprobare	Text de aprobare suplimentar	Nume certificat
	CCA DEKRA Certification B.V.	EN 60947	2160584.16
	CCA DEKRA Certification B.V.	EN 60947	NTR NL-7097
	CSA DEKRA Certification B.V.	C22.2 No. 158	1604421

## UL-Approvals

Emblemă	Aprobare	Text de aprobare suplimentar	Nume certificat
	UR Underwriters Laboratories Inc.	UL 1059	E45172 sec6

## Counterpart

## Produse compatibile

## tools



Nr. articol: 210-721

Operating tool; Blade: 5.5 x 0.8 mm; with a partially insulated shaft

[www.wago.com/210-721](http://www.wago.com/210-721)

## check



Nr. articol: 210-136

Test plug; 2 mm Ø; with 500 mm cable; red

[www.wago.com/210-136](http://www.wago.com/210-136)

Nr. articol: 210-137

Supus modificărilor.

WAGO Kontakttechnik GmbH & Co. KG  
/Representative Office Romania  
Sos. Pipera-Tunari nr. 1/1  
building 1, 2nd floor | 077190 Voluntari, Ilfov  
Tel.: +40-(0)31 421 85 68 | Email: info-RO@wago.com

Aveți întrebări despre produsele noastre?  
Vă stăm la dispoziție pentru preluarea apelului la +40 (0) 31 421 85 68.



Test plug; 2.3 mm Ø; with 500 mm cable; yellow

[www.wago.com/210-137](http://www.wago.com/210-137)

---

**Jumper**

**Nr. articol: 745-380**  
 Comb-style jumper bar; 10-way
[www.wago.com/745-380](http://www.wago.com/745-380)
**Nr. articol: 745-381**  
 Comb-style jumper bar; 2-way (1-3)
[www.wago.com/745-381](http://www.wago.com/745-381)
**Nr. articol: 745-382**  
 Comb-style jumper bar; 2-way
[www.wago.com/745-382](http://www.wago.com/745-382)
**Nr. articol: 745-383**  
 Comb-style jumper bar; 3-way
[www.wago.com/745-383](http://www.wago.com/745-383)
**Nr. articol: 745-384**  
 Comb-style jumper bar; 4-way
[www.wago.com/745-384](http://www.wago.com/745-384)
**Nr. articol: 745-385**  
 Comb-style jumper bar; 5-way
[www.wago.com/745-385](http://www.wago.com/745-385)

---















**Marking accessories**

**Nr. articol: 2009-115**  
 WMB-Inline; for Smart Printer; 1500 pieces on roll; stretchable 5 - 5.2 mm; plain; snap-on type; white
[www.wago.com/2009-115](http://www.wago.com/2009-115)
**Nr. articol: 2009-115/000-002**  
 WMB-Inline; for Smart Printer; 1500 pieces on roll; stretchable 5 - 5.2 mm; plain; snap-on type; yellow
[www.wago.com/2009-115/000-002](http://www.wago.com/2009-115/000-002)
**Nr. articol: 2009-115/000-006**  
 WMB-Inline; for Smart Printer; 1500 pieces on roll; stretchable 5 - 5.2 mm; plain; snap-on type; blue
[www.wago.com/2009-115/000-006](http://www.wago.com/2009-115/000-006)
**Nr. articol: 2009-115/000-007**  
 WMB-Inline; for Smart Printer; 1500 pieces on roll; stretchable 5 - 5.2 mm; plain; snap-on type; gray
[www.wago.com/2009-115/000-007](http://www.wago.com/2009-115/000-007)
**Nr. articol: 2009-115/000-012**  
 WMB-Inline; for Smart Printer; 1500 pieces on roll; stretchable 5 - 5.2 mm; plain; snap-on type; orange
[www.wago.com/2009-115/000-012](http://www.wago.com/2009-115/000-012)
**Nr. articol: 2009-115/000-017**  
 WMB-Inline; for Smart Printer; 1500 pieces on roll; stretchable 5 - 5.2 mm; plain; snap-on type; light green
[www.wago.com/2009-115/000-017](http://www.wago.com/2009-115/000-017)
**Nr. articol: 2009-115/000-023**  
 WMB-Inline; for Smart Printer; 1500 pieces on roll; stretchable 5 - 5.2 mm; plain; snap-on type; green
[www.wago.com/2009-115/000-023](http://www.wago.com/2009-115/000-023)
**Nr. articol: 2009-115/000-024**  
 WMB-Inline; for Smart Printer; 1500 pieces on roll; stretchable 5 - 5.2 mm; plain; snap-on type; violet
[www.wago.com/2009-115/000-024](http://www.wago.com/2009-115/000-024)

Supus modificărilor.

WAGO Kontakttechnik GmbH & Co. KG  
 /Representative Office Romania  
 Sos. Pipera-Tunari nr. 1/1  
 building 1, 2nd floor | 077190 Voluntari, Ilfov  
 Tel.: +40-(0)31 421 85 68 | Email: info-RO@wago.com

Aveți întrebări despre produsele noastre?  
 Vă stăm la dispoziție pentru preluarea apelului la +40 (0) 31 421 85 68.

	<b>Nr. articol: 2009-145</b> Mini-WSB Inline; for Smart Printer; 1700 pieces on roll; stretchable 5 - 5.2 mm; plain; snap-on type; white	<a href="http://www.wago.com/2009-145">www.wago.com/2009-145</a>
	<b>Nr. articol: 2009-145/000-002</b> Mini-WSB Inline; for Smart Printer; 1700 pieces on roll; stretchable 5 - 5.2 mm; plain; snap-on type; yellow	<a href="http://www.wago.com/2009-145/000-002">www.wago.com/2009-145/000-002</a>
	<b>Nr. articol: 2009-145/000-005</b> Mini-WSB Inline; for Smart Printer; 1700 pieces on roll; stretchable 5 - 5.2 mm; plain; snap-on type; red	<a href="http://www.wago.com/2009-145/000-005">www.wago.com/2009-145/000-005</a>
	<b>Nr. articol: 2009-145/000-006</b> Mini-WSB Inline; for Smart Printer; 1700 pieces on roll; stretchable 5 - 5.2 mm; plain; snap-on type; blue	<a href="http://www.wago.com/2009-145/000-006">www.wago.com/2009-145/000-006</a>
	<b>Nr. articol: 2009-145/000-007</b> Mini-WSB Inline; for Smart Printer; 1700 pieces on roll; stretchable 5 - 5.2 mm; plain; snap-on type; gray	<a href="http://www.wago.com/2009-145/000-007">www.wago.com/2009-145/000-007</a>
	<b>Nr. articol: 2009-145/000-012</b> Mini-WSB Inline; for Smart Printer; 1700 pieces on roll; stretchable 5 - 5.2 mm; plain; snap-on type; orange	<a href="http://www.wago.com/2009-145/000-012">www.wago.com/2009-145/000-012</a>
	<b>Nr. articol: 2009-145/000-023</b> Mini-WSB Inline; for Smart Printer; 1700 pieces on roll; stretchable 5 - 5.2 mm; plain; snap-on type; green	<a href="http://www.wago.com/2009-145/000-023">www.wago.com/2009-145/000-023</a>
	<b>Nr. articol: 2009-145/000-024</b> Mini-WSB Inline; for Smart Printer; 1700 pieces on roll; stretchable 5 - 5.2 mm; plain; snap-on type; violet	<a href="http://www.wago.com/2009-145/000-024">www.wago.com/2009-145/000-024</a>
	<b>Nr. articol: 248-501</b> Miniature WSB Quick marking system; plain; Marker width 5 mm; 10 strips with 10 markers per card	<a href="http://www.wago.com/248-501">www.wago.com/248-501</a>
	<b>Nr. articol: 248-501/000-002</b> Mini-WSB marking card; as card; not stretchable; plain; snap-on type; yellow	<a href="http://www.wago.com/248-501/000-002">www.wago.com/248-501/000-002</a>
	<b>Nr. articol: 248-501/000-005</b> Mini-WSB marking card; as card; not stretchable; plain; snap-on type; red	<a href="http://www.wago.com/248-501/000-005">www.wago.com/248-501/000-005</a>
	<b>Nr. articol: 248-501/000-006</b> Mini-WSB marking card; as card; not stretchable; plain; snap-on type; blue	<a href="http://www.wago.com/248-501/000-006">www.wago.com/248-501/000-006</a>
	<b>Nr. articol: 248-501/000-007</b> Mini-WSB marking card; as card; not stretchable; plain; snap-on type; gray	<a href="http://www.wago.com/248-501/000-007">www.wago.com/248-501/000-007</a>
	<b>Nr. articol: 248-501/000-012</b> Mini-WSB marking card; as card; not stretchable; plain; snap-on type; orange	<a href="http://www.wago.com/248-501/000-012">www.wago.com/248-501/000-012</a>

Supus modificărilor.

**Nr. articol:** 248-501/000-017

Mini-WSB marking card; as card; not stretchable; plain; snap-on type; light green

[www.wago.com/248-501/000-017](http://www.wago.com/248-501/000-017)**Nr. articol:** 248-501/000-023

Mini-WSB marking card; as card; not stretchable; plain; snap-on type; green

[www.wago.com/248-501/000-023](http://www.wago.com/248-501/000-023)**Nr. articol:** 248-501/000-024

Mini-WSB marking card; as card; not stretchable; plain; snap-on type; violet

[www.wago.com/248-501/000-024](http://www.wago.com/248-501/000-024)**Nr. articol:** 793-501

WMB marking card; as card; not stretchable; plain; snap-on type; white

[www.wago.com/793-501](http://www.wago.com/793-501)**Nr. articol:** 793-501/000-002

WMB marking card; as card; not stretchable; plain; snap-on type; yellow

[www.wago.com/793-501/000-002](http://www.wago.com/793-501/000-002)**Nr. articol:** 793-501/000-005

WMB marking card; as card; not stretchable; plain; snap-on type; red

[www.wago.com/793-501/000-005](http://www.wago.com/793-501/000-005)**Nr. articol:** 793-501/000-006

WMB marking card; as card; not stretchable; plain; snap-on type; blue

[www.wago.com/793-501/000-006](http://www.wago.com/793-501/000-006)**Nr. articol:** 793-501/000-007

WMB marking card; as card; not stretchable; plain; snap-on type; gray

[www.wago.com/793-501/000-007](http://www.wago.com/793-501/000-007)**Nr. articol:** 793-501/000-012

WMB marking card; as card; not stretchable; plain; snap-on type; orange

[www.wago.com/793-501/000-012](http://www.wago.com/793-501/000-012)**Nr. articol:** 793-501/000-017

WMB marking card; as card; not stretchable; plain; snap-on type; light green

[www.wago.com/793-501/000-017](http://www.wago.com/793-501/000-017)**Nr. articol:** 793-501/000-023

WMB marking card; as card; not stretchable; plain; snap-on type; green

[www.wago.com/793-501/000-023](http://www.wago.com/793-501/000-023)**Nr. articol:** 793-501/000-024

WMB marking card; as card; not stretchable; plain; snap-on type; violet

[www.wago.com/793-501/000-024](http://www.wago.com/793-501/000-024)**Nr. articol:** 793-5501

WMB marking card; as card; for terminal block width 5 - 17.5 mm; stretchable 5 - 5.2 mm; plain; snap-on type; white















[www.wago.com/793-5501](http://www.wago.com/793-5501)**Nr. articol:** 793-5501/000-002

WMB marking card; as card; for terminal block width 5 - 17.5 mm; stretchable 5 - 5.2 mm; plain; snap-on type; yellow

















[www.wago.com/793-5501/000-002](http://www.wago.com/793-5501/000-002)

Supus modificărilor.



	<b>Nr. articol: 793-5501/000-005</b> WMB marking card; as card; for terminal block width 5 - 17.5 mm; stretchable 5 - 5.2 mm; plain; snap-on type; red	<a href="http://www.wago.com/793-5501/000-005">www.wago.com/793-5501/000-005</a>
	<b>Nr. articol: 793-5501/000-006</b> WMB marking card; as card; for terminal block width 5 - 17.5 mm; stretchable 5 - 5.2 mm; plain; snap-on type; blue	<a href="http://www.wago.com/793-5501/000-006">www.wago.com/793-5501/000-006</a>
	<b>Nr. articol: 793-5501/000-007</b> WMB marking card; as card; for terminal block width 5 - 17.5 mm; stretchable 5 - 5.2 mm; plain; snap-on type; gray	<a href="http://www.wago.com/793-5501/000-007">www.wago.com/793-5501/000-007</a>
	<b>Nr. articol: 793-5501/000-012</b> WMB marking card; as card; for terminal block width 5 - 17.5 mm; stretchable 5 - 5.2 mm; plain; snap-on type; orange	<a href="http://www.wago.com/793-5501/000-012">www.wago.com/793-5501/000-012</a>
	<b>Nr. articol: 793-5501/000-017</b> WMB marking card; as card; for terminal block width 5 - 17.5 mm; stretchable 5 - 5.2 mm; plain; snap-on type; green	<a href="http://www.wago.com/793-5501/000-017">www.wago.com/793-5501/000-017</a>
	<b>Nr. articol: 793-5501/000-023</b> WMB marking card; as card; for terminal block width 5 - 17.5 mm; stretchable 5 - 5.2 mm; plain; snap-on type; light green	<a href="http://www.wago.com/793-5501/000-023">www.wago.com/793-5501/000-023</a>
	<b>Nr. articol: 793-5501/000-024</b> WMB marking card; as card; for terminal block width 5 - 17.5 mm; stretchable 5 - 5.2 mm; plain; snap-on type; violet	<a href="http://www.wago.com/793-5501/000-024">www.wago.com/793-5501/000-024</a>
<b>ferrule</b>		
	<b>Nr. articol: 216-101</b> Ferrule; Sleeve for 0.5 mm <sup>2</sup> / AWG 22; uninsulated; electro-tin plated	<a href="http://www.wago.com/216-101">www.wago.com/216-101</a>
	<b>Nr. articol: 216-102</b> Ferrule; Sleeve for 0.75 mm <sup>2</sup> / AWG 20; uninsulated; electro-tin plated	<a href="http://www.wago.com/216-102">www.wago.com/216-102</a>
	<b>Nr. articol: 216-103</b> Ferrule; Sleeve for 1 mm <sup>2</sup> / AWG 18; uninsulated; electro-tin plated	<a href="http://www.wago.com/216-103">www.wago.com/216-103</a>
	<b>Nr. articol: 216-104</b> Ferrule; Sleeve for 1.5 mm <sup>2</sup> / AWG 16; uninsulated; electro-tin plated	<a href="http://www.wago.com/216-104">www.wago.com/216-104</a>
	<b>Nr. articol: 216-106</b> Ferrule; Sleeve for 2.5 mm <sup>2</sup> / AWG 14; uninsulated; electro-tin plated	<a href="http://www.wago.com/216-106">www.wago.com/216-106</a>
	<b>Nr. articol: 216-107</b> Ferrule; Sleeve for 4 mm <sup>2</sup> / AWG 12; uninsulated; electro-tin plated	<a href="http://www.wago.com/216-107">www.wago.com/216-107</a>
	<b>Nr. articol: 216-108</b> Ferrule; Sleeve for 6 mm <sup>2</sup> / AWG 10; uninsulated; electro-tin plated	<a href="http://www.wago.com/216-108">www.wago.com/216-108</a>
	<b>Nr. articol: 216-109</b> Ferrule; Sleeve for 10 mm <sup>2</sup> / AWG 8; uninsulated; electro-tin plated	<a href="http://www.wago.com/216-109">www.wago.com/216-109</a>

Supus modificărilor.

	<b>Nr. articol: 216-110</b> Ferrule; Sleeve for 16 mm <sup>2</sup> / AWG 6; uninsulated; electro-tin plated	<a href="http://www.wago.com/216-110">www.wago.com/216-110</a>
	<b>Nr. articol: 216-121</b> Ferrule; Sleeve for 0.5 mm <sup>2</sup> / AWG 22; uninsulated; electro-tin plated	<a href="http://www.wago.com/216-121">www.wago.com/216-121</a>
	<b>Nr. articol: 216-122</b> Ferrule; Sleeve for 0.75 mm <sup>2</sup> / AWG 20; uninsulated; electro-tin plated	<a href="http://www.wago.com/216-122">www.wago.com/216-122</a>
	<b>Nr. articol: 216-123</b> Ferrule; Sleeve for 1 mm <sup>2</sup> / AWG 18; uninsulated; electro-tin plated	<a href="http://www.wago.com/216-123">www.wago.com/216-123</a>
	<b>Nr. articol: 216-124</b> Ferrule; Sleeve for 1.5 mm <sup>2</sup> / AWG 16; uninsulated; electro-tin plated	<a href="http://www.wago.com/216-124">www.wago.com/216-124</a>
	<b>Nr. articol: 216-131</b> Ferrule; Sleeve for 0.25 mm <sup>2</sup> / AWG 24; uninsulated; electro-tin plated	<a href="http://www.wago.com/216-131">www.wago.com/216-131</a>
	<b>Nr. articol: 216-132</b> Ferrule; Sleeve for 0.34 mm <sup>2</sup> / AWG 24; uninsulated; electro-tin plated	<a href="http://www.wago.com/216-132">www.wago.com/216-132</a>
	<b>Nr. articol: 216-141</b> Ferrule; Sleeve for 0.5 mm <sup>2</sup> / 20 AWG; uninsulated; electro-tin plated; electrolytic copper; gastight crimped; acc. to DIN 46228, Part 1/08.92	<a href="http://www.wago.com/216-141">www.wago.com/216-141</a>
	<b>Nr. articol: 216-142</b> Ferrule; Sleeve for 0.75 mm <sup>2</sup> / 18 AWG; uninsulated; electro-tin plated; electrolytic copper; gastight crimped; acc. to DIN 46228, Part 1/08.92	<a href="http://www.wago.com/216-142">www.wago.com/216-142</a>
	<b>Nr. articol: 216-143</b> Ferrule; Sleeve for 1 mm <sup>2</sup> / AWG 18; uninsulated; electro-tin plated; electrolytic copper; gastight crimped; acc. to DIN 46228, Part 1/08.92	<a href="http://www.wago.com/216-143">www.wago.com/216-143</a>
	<b>Nr. articol: 216-144</b> Ferrule; Sleeve for 1.5 mm <sup>2</sup> / AWG 16; uninsulated; electro-tin plated; electrolytic copper; gastight crimped; acc. to DIN 46228, Part 1/08.92	<a href="http://www.wago.com/216-144">www.wago.com/216-144</a>
	<b>Nr. articol: 216-151</b> Ferrule; Sleeve for 0.25 mm <sup>2</sup> / AWG 24; uninsulated; electro-tin plated	<a href="http://www.wago.com/216-151">www.wago.com/216-151</a>
	<b>Nr. articol: 216-152</b> Ferrule; Sleeve for 0.34 mm <sup>2</sup> / AWG 24; uninsulated; electro-tin plated	<a href="http://www.wago.com/216-152">www.wago.com/216-152</a>
	<b>Nr. articol: 216-201</b> Ferrule; Sleeve for 0.5 mm <sup>2</sup> / 20 AWG; insulated; electro-tin plated; white	<a href="http://www.wago.com/216-201">www.wago.com/216-201</a>
	<b>Nr. articol: 216-202</b> Ferrule; Sleeve for 0.75 mm <sup>2</sup> / 18 AWG; insulated; electro-tin plated; gray	<a href="http://www.wago.com/216-202">www.wago.com/216-202</a>
	<b>Nr. articol: 216-203</b> Ferrule; Sleeve for 1 mm <sup>2</sup> / AWG 18; insulated; electro-tin plated; red	<a href="http://www.wago.com/216-203">www.wago.com/216-203</a>
	<b>Nr. articol: 216-204</b> Ferrule; Sleeve for 1.5 mm <sup>2</sup> / AWG 16; insulated; electro-tin plated; black	<a href="http://www.wago.com/216-204">www.wago.com/216-204</a>
	<b>Nr. articol: 216-205</b> Ferrule; Sleeve for 2.08 mm <sup>2</sup> / AWG 14; insulated; electro-tin plated; yellow	<a href="http://www.wago.com/216-205">www.wago.com/216-205</a>

Supus modificărilor.

**Nr. articol: 216-206**Ferrule; Sleeve for 2.5 mm<sup>2</sup> / AWG 14; insulated; electro-tin plated; blue[www.wago.com/216-206](http://www.wago.com/216-206)**Nr. articol: 216-207**Ferrule; Sleeve for 4 mm<sup>2</sup> / AWG 12; insulated; electro-tin plated; gray[www.wago.com/216-207](http://www.wago.com/216-207)**Nr. articol: 216-208**Ferrule; Sleeve for 6 mm<sup>2</sup> / AWG 10; insulated; electro-tin plated; electrolytic copper; gastight crimped; acc. to DIN 46228, Part 4/09.90; yellow[www.wago.com/216-208](http://www.wago.com/216-208)**Nr. articol: 216-209**Ferrule; Sleeve for 10 mm<sup>2</sup> / AWG 8; insulated; electro-tin plated; red[www.wago.com/216-209](http://www.wago.com/216-209)**Nr. articol: 216-210**Ferrule; Sleeve for 16 mm<sup>2</sup> / AWG 6; insulated; electro-tin plated; electrolytic copper; gastight crimped; acc. to DIN 46228, Part 4/09.90; blue[www.wago.com/216-210](http://www.wago.com/216-210)**Nr. articol: 216-221**Ferrule; Sleeve for 0.5 mm<sup>2</sup> / 20 AWG; insulated; electro-tin plated; white[www.wago.com/216-221](http://www.wago.com/216-221)**Nr. articol: 216-222**Ferrule; Sleeve for 0.75 mm<sup>2</sup> / 18 AWG; insulated; electro-tin plated; gray[www.wago.com/216-222](http://www.wago.com/216-222)**Nr. articol: 216-223**Ferrule; Sleeve for 1 mm<sup>2</sup> / AWG 18; insulated; electro-tin plated; red[www.wago.com/216-223](http://www.wago.com/216-223)**Nr. articol: 216-224**Ferrule; Sleeve for 1.5 mm<sup>2</sup> / AWG 16; insulated; electro-tin plated; black[www.wago.com/216-224](http://www.wago.com/216-224)**Nr. articol: 216-241**Ferrule; Sleeve for 0.5 mm<sup>2</sup> / 20 AWG; insulated; electro-tin plated; electrolytic copper; gastight crimped; acc. to DIN 46228, Part 4/09.90; white[www.wago.com/216-241](http://www.wago.com/216-241)**Nr. articol: 216-242**Ferrule; Sleeve for 0.75 mm<sup>2</sup> / 18 AWG; insulated; electro-tin plated; electrolytic copper; gastight crimped; acc. to DIN 46228, Part 4/09.90; gray[www.wago.com/216-242](http://www.wago.com/216-242)**Nr. articol: 216-243**Ferrule; Sleeve for 1 mm<sup>2</sup> / AWG 18; insulated; electro-tin plated; electrolytic copper; gastight crimped; acc. to DIN 46228, Part 4/09.90; red[www.wago.com/216-243](http://www.wago.com/216-243)**Nr. articol: 216-244**Ferrule; Sleeve for 1.5 mm<sup>2</sup> / AWG 16; insulated; electro-tin plated; electrolytic copper; gastight crimped; acc. to DIN 46228, Part 4/09.90; black[www.wago.com/216-244](http://www.wago.com/216-244)**Nr. articol: 216-246**Ferrule; Sleeve for 2.5 mm<sup>2</sup> / AWG 14; insulated; electro-tin plated; electrolytic copper; gastight crimped; acc. to DIN 46228, Part 4/09.90; blue[www.wago.com/216-246](http://www.wago.com/216-246)**Nr. articol: 216-262**Ferrule; Sleeve for 0.75 mm<sup>2</sup> / 18 AWG; insulated; electro-tin plated; electrolytic copper; gastight crimped; acc. to DIN 46228, Part 4/09.90; gray[www.wago.com/216-262](http://www.wago.com/216-262)**Nr. articol: 216-263**Ferrule; Sleeve for 1 mm<sup>2</sup> / AWG 18; insulated; electro-tin plated; electrolytic copper; gastight crimped; acc. to DIN 46228, Part 4/09.90; red[www.wago.com/216-263](http://www.wago.com/216-263)

Supus modificărilor.

WAGO Kontakttechnik GmbH &amp; Co. KG

/Representative Office Romania









Sos. Pipera-Tunari nr. 1/1

building 1, 2nd floor | 077190 Voluntari, Ilfov

Tel.: +40-(0)31 421 85 68 | Email: info-RO@wago.com

Aveți întrebări despre produsele noastre?

Vă stăm la dispoziție pentru preluarea apelului la +40 (0) 31 421 85 68.

	<b>Nr. articol: 216-264</b> Ferrule; Sleeve for 1.5 mm <sup>2</sup> / AWG 16; insulated; electro-tin plated; electrolytic copper; gastight crimped; acc. to DIN 46228, Part 4/09.90; black	<a href="http://www.wago.com/216-264">www.wago.com/216-264</a>
	<b>Nr. articol: 216-266</b> Ferrule; Sleeve for 2.5 mm <sup>2</sup> / AWG 14; insulated; electro-tin plated; electrolytic copper; gastight crimped; acc. to DIN 46228, Part 4/09.90; blue	<a href="http://www.wago.com/216-266">www.wago.com/216-266</a>
	<b>Nr. articol: 216-267</b> Ferrule; Sleeve for 4 mm <sup>2</sup> / AWG 12; insulated; electro-tin plated; electrolytic copper; gastight crimped; acc. to DIN 46228, Part 4/09.90; gray	<a href="http://www.wago.com/216-267">www.wago.com/216-267</a>
	<b>Nr. articol: 216-284</b> Ferrule; Sleeve for 1.5 mm <sup>2</sup> / AWG 16; insulated; electro-tin plated; electrolytic copper; gastight crimped; acc. to DIN 46228, Part 4/09.90; black	<a href="http://www.wago.com/216-284">www.wago.com/216-284</a>
	<b>Nr. articol: 216-286</b> Ferrule; Sleeve for 2.5 mm <sup>2</sup> / AWG 14; insulated; electro-tin plated; electrolytic copper; gastight crimped; acc. to DIN 46228, Part 4/09.90; blue	<a href="http://www.wago.com/216-286">www.wago.com/216-286</a>
	<b>Nr. articol: 216-287</b> Ferrule; Sleeve for 4 mm <sup>2</sup> / AWG 12; insulated; electro-tin plated; electrolytic copper; gastight crimped; acc. to DIN 46228, Part 4/09.90; gray	<a href="http://www.wago.com/216-287">www.wago.com/216-287</a>
	<b>Nr. articol: 216-288</b> Ferrule; Sleeve for 6 mm <sup>2</sup> / AWG 10; insulated; electro-tin plated; electrolytic copper; gastight crimped; acc. to DIN 46228, Part 4/09.90; yellow	<a href="http://www.wago.com/216-288">www.wago.com/216-288</a>
	<b>Nr. articol: 216-289</b> Ferrule; Sleeve for 10 mm <sup>2</sup> / AWG 8; insulated; electro-tin plated; electrolytic copper; gastight crimped; acc. to DIN 46228, Part 4/09.90; red	<a href="http://www.wago.com/216-289">www.wago.com/216-289</a>
	<b>Nr. articol: 216-301</b> Ferrule; Sleeve for 0.25 mm <sup>2</sup> / AWG 24; insulated; electro-tin plated; yellow	<a href="http://www.wago.com/216-301">www.wago.com/216-301</a>
	<b>Nr. articol: 216-302</b> Ferrule; Sleeve for 0.34 mm <sup>2</sup> / 22 AWG; insulated; electro-tin plated; green	<a href="http://www.wago.com/216-302">www.wago.com/216-302</a>
	<b>Nr. articol: 216-321</b> Ferrule; Sleeve for 0.25 mm <sup>2</sup> / AWG 24; insulated; electro-tin plated; yellow	<a href="http://www.wago.com/216-321">www.wago.com/216-321</a>
	<b>Nr. articol: 216-322</b> Ferrule; Sleeve for 0.34 mm <sup>2</sup> / 22 AWG; insulated; electro-tin plated; green	<a href="http://www.wago.com/216-322">www.wago.com/216-322</a>

## Descărcări

### Documentation

#### Additional Information

Technical explanations

Apr 3, 2019

pdf  
3,6 MB

Descărcare

## CAD/CAE-Data

### CAD data

Supus modificărilor.

WAGO Kontakttechnik GmbH & Co. KG  
/Representative Office Romania  
Sos. Pipera-Tunari nr. 1/1  
building 1, 2nd floor | 077190 Voluntari, Ilfov  
Tel.: +40-(0)31 421 85 68 | Email: info-RO@wago.com

Aveți întrebări despre produsele noastre?  
Vă stăm la dispoziție pentru preluarea apelului la +40 (0) 31 421 85 68.



2D/3D Models 745-307

[URL](#)

[Descărcare](#)

#### CAE data

EPLAN Data Portal 745-307

[URL](#)

[Descărcare](#)

#### PCB Design

Symbol and Footprint 745-307

[URL](#)

[Descărcare](#)

CAX data for your PCB design, consisting of "schematic symbols and PCB footprints", allow easy integration of the WAGO component into your development environment.

#### Supported formats:

- Accel EDA 14 & 15
- Altium 6 to current version
- Cadence Allegro
- DesignSpark
- Eagle Libraries
- KiCad
- Mentor Graphics BoardStation
- Mentor Graphics Design Architect
- Mentor Graphics Design Expedition 99 and 2000
- OrCAD 9.X PCB and Capture
- PADS PowerPCB 3, 3.5, 4.X, and 5.X
- PADS PowerPCB and PowerLogic 3.0
- PCAD 2000, 2001, 2002, 2004, and 2006
- Pulsonix 8.5 or newer
- STL
- 3D STEP
- TARGET 3001!
- View Logic ViewDraw
- Quadcept
- Zuken CadStar 3 and 4
- Zuken CR-5000 and CR-8000

PCB Component Libraries (EDA), PCB CAD Library Ultra Librarian

## Installation Notes

Supus modificărilor.

WAGO Kontakttechnik GmbH & Co. KG  
/Representative Office Romania  
Sos. Pipera-Tunari nr. 1/1  
building 1, 2nd floor | 077190 Voluntari, Ilfov  
Tel.: +40-(0)31 421 85 68 | Email: info-RO@wago.com

Aveți întrebări despre produsele noastre?  
Vă stăm la dispoziție pentru preluarea apelului la +40 (0) 31 421 85 68.

### Conductor termination

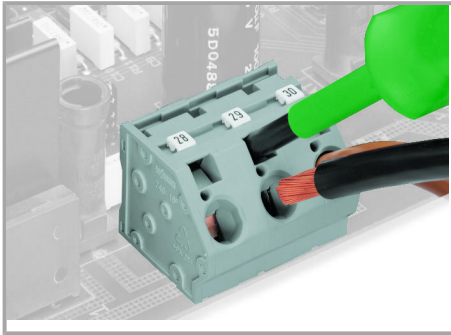

Inserting/removing a conductor via 5.5 mm screwdriver – 745 Series, 16 mm<sup>2</sup>.

### Marking

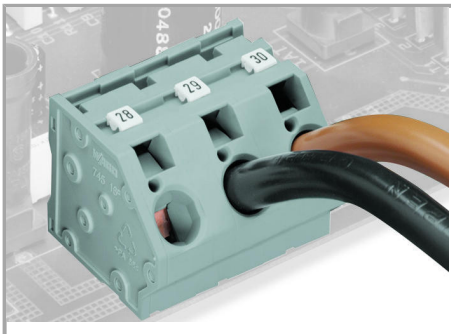

Marking via miniature WSB and WMB markers or factory direct marking – 745 Series.

### Testing

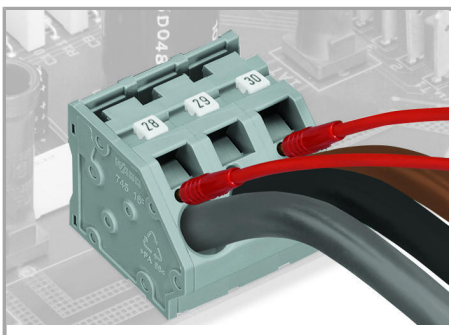

Testing with test plug – 745 Series.

### Commoning

Supus modificărilor.

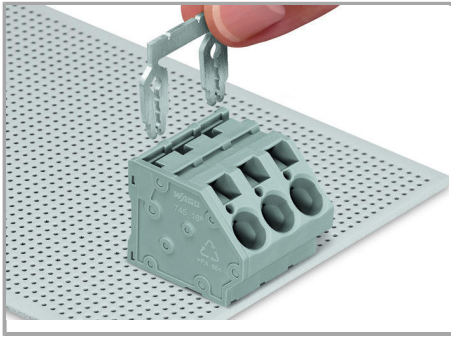

Inserting a comb-style jumper bar.

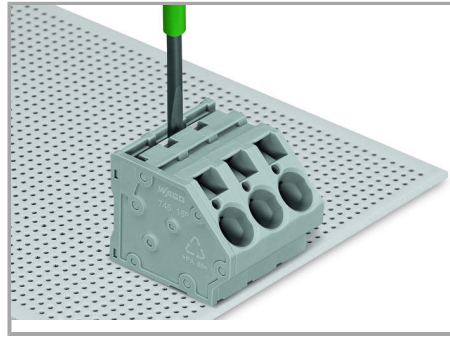

To insert a comb-style jumper bar, push it down using a screwdriver until it hits the backstop – 745 Series.

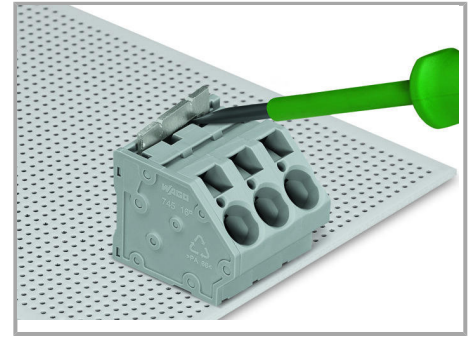

To remove the comb-style jumper bar, lift it up using a screwdriver – 745 Series.

Supus modificărilor.