

Fișă tehnică | Număr articol: 279-809/281-434

Component terminal block; 4-conductor; LED (red); 24 VDC; for DIN-rail 35 x 15 and 35 x 7.5; 1.5 mm²; CAGE CLAMP®; 1,50 mm²; gray

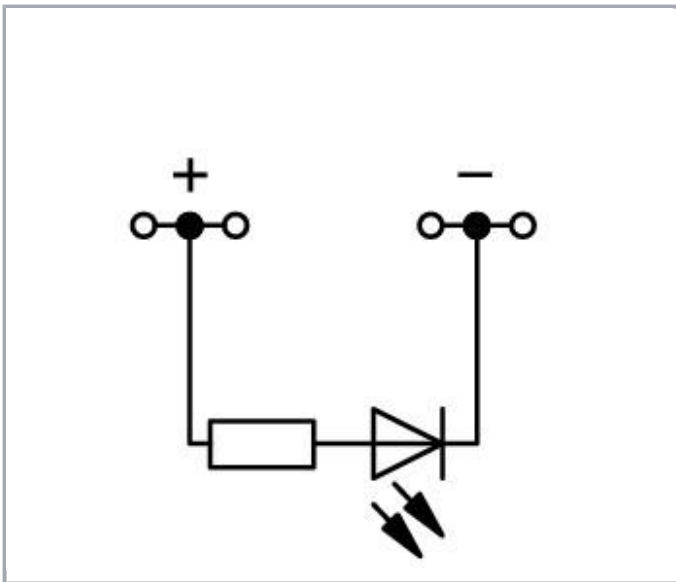

www.wago.com/279-809/281-434

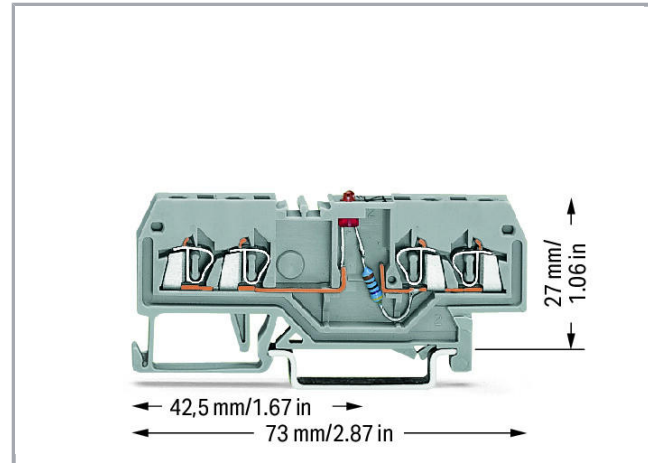
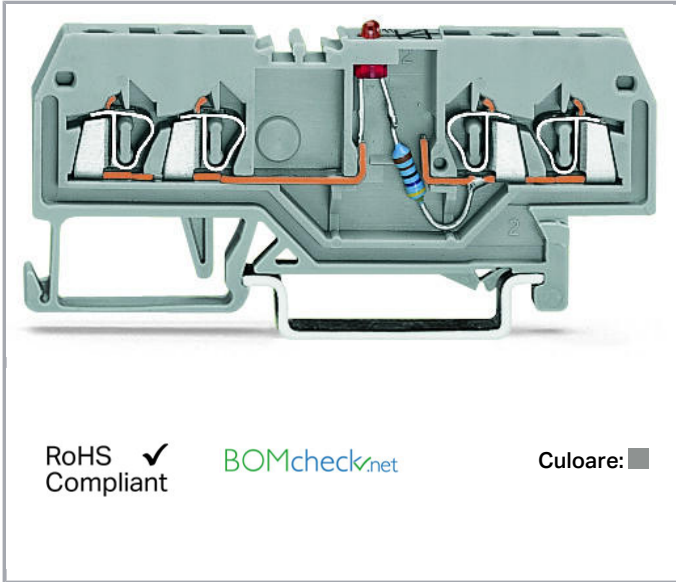

Date

Electrical data

Voltage type 1	DC
Nominal voltage	24 V

Supus modificărilor.

WAGO Kontakttechnik GmbH & Co. KG
/Representative Office Romania
Sos. Pipera-Tunari nr. 1/1
building 1, 2nd floor | 077190 Voluntari, Ilfov
Tel.: +40-(0)31 421 85 68 | Email: info-RO@wago.com

Aveți întrebări despre produsele noastre?
Vă stăm la dispoziție pentru preluarea apelului la +40 (0) 31 421 85 68.



Ratings per IEC/EN 60664-1

Ratings per	IEC/EN 60947-7-1
Rated current	0,025 A

Connection data

Connection technology	CAGE CLAMP®
Actuation type	Operating tool
Connectable conductor materials	Copper
Solid conductor	0.08 ... 1.5 mm ² / 28 ... 16 AWG
Fine-stranded conductor	0.08 ... 1.5 mm ² / 28 ... 16 AWG
Strip length	8 ... 9 mm / 0.31 ... 0.35 inch
Total number of connection points	4
Total number of potentials	1
Number of levels	1
Wiring type	Front-entry wiring

Geometrical Data

Width	4 mm / 0.157 inch
Height from upper-edge of DIN-rail	27 mm / 1.063 inch
Depth	73 mm / 2.874 inch

Mechanical data

Design	horizontal
Mounting type	DIN-35 rail
Marking level	Center marking

Material Data

Color	gray
Insulation material	Polyamide 66 (PA 66)
Fire load	0,12 MJ
Weight	6,6 g

Commercial data

Product Group	1 (Rail Mounted Terminal Blocks)
Packaging type	BOX

Supus modificărilor.

WAGO Kontakttechnik GmbH & Co. KG
 /Representative Office Romania
 Sos. Pipera-Tunari nr. 1/1
 building 1, 2nd floor | 077190 Voluntari, Ilfov
 Tel.: +40-(0)31 421 85 68 | Email: info-RO@wago.com

Aveți întrebări despre produsele noastre?
 Vă stăm la dispoziție pentru preluarea apelului la +40 (0) 31 421 85 68.

Country of origin	DE
GTIN	4045454194109
Customs tariff number	85369010000

Counterpart

Produse compatibile

assembling



Nr. articol: 209-106

Mounting carrier; for isolated mounting on DIN 35 rails; gray

www.wago.com/209-106



Nr. articol: 709-153

Cover; Type 1; suitable for cover carrier, type 1; 1 m long; transparent

www.wago.com/709-153

ferrule



Nr. articol: 216-101

Ferrule; Sleeve for 0.5 mm² / AWG 22; uninsulated; electro-tin plated

www.wago.com/216-101



Nr. articol: 216-102

Ferrule; Sleeve for 0.75 mm² / AWG 20; uninsulated; electro-tin plated

www.wago.com/216-102



Nr. articol: 216-103

Ferrule; Sleeve for 1 mm² / AWG 18; uninsulated; electro-tin plated

www.wago.com/216-103



Nr. articol: 216-201

Ferrule; Sleeve for 0.5 mm² / 20 AWG; insulated; electro-tin plated; white

www.wago.com/216-201



Nr. articol: 216-202

Ferrule; Sleeve for 0.75 mm² / 18 AWG; insulated; electro-tin plated; gray

www.wago.com/216-202



Nr. articol: 216-203

Ferrule; Sleeve for 1 mm² / AWG 18; insulated; electro-tin plated; red

www.wago.com/216-203

Nr. articol: 216-301

Ferrule; Sleeve for 0.25 mm² / AWG 24; insulated; electro-tin plated; yellow

www.wago.com/216-301



Nr. articol: 216-302

Ferrule; Sleeve for 0.34 mm² / 22 AWG; insulated; electro-tin plated; green

















www.wago.com/216-302

Insulation stop

Supus modificărilor.

WAGO Kontakttechnik GmbH & Co. KG
/Representative Office Romania
Sos. Pipera-Tunari nr. 1/1
building 1, 2nd floor | 077190 Voluntari, Ilfov
Tel.: +40-(0)31 421 85 68 | Email: info-RO@wago.com

















Aveți întrebări despre produsele noastre?
Vă stăm la dispoziție pentru preluarea apelului la +40 (0) 31 421 85 68.

	Nr. articol: 279-470 Insulation stop; 0.08 - 0.2 mm ² "s" (0.14 mm ² "f-st"); 5 pieces/strip; white	www.wago.com/279-470
	Nr. articol: 279-471 Insulation stop; 0.25 mm ² ; 5 pieces/strip; dark gray	www.wago.com/279-471
End plate		
	Nr. articol: 279-344 End and intermediate plate; 2 mm thick; gray	www.wago.com/279-344
	Nr. articol: 279-345 Separator plate; 2 mm thick; oversized; gray	www.wago.com/279-345
	Nr. articol: 279-346 End and intermediate plate; 2 mm thick; orange	www.wago.com/279-346
	Nr. articol: 279-347 Separator plate; 2 mm thick; oversized; orange	www.wago.com/279-347
Protective Warning Marker		
	Nr. articol: 279-415 Protective warning marker; with high-voltage symbol, black; for 5 terminal blocks; yellow	www.wago.com/279-415
Carrier rail		
	Nr. articol: 210-112 Steel carrier rail; 35 x 7.5 mm; 1 mm thick; 2 m long; slotted; according to EN 60715; "Hole width 25 mm	www.wago.com/210-112
	Nr. articol: 210-113 Steel carrier rail; 35 x 7.5 mm; 1 mm thick; 2 m long; unslotted; according to EN 60715	www.wago.com/210-113
	Nr. articol: 210-114 Steel carrier rail; 35 x 15 mm; 1.5 mm thick; 2 m long; unslotted; similar to EN 60715	www.wago.com/210-114
	Nr. articol: 210-115 Steel carrier rail; 35 x 7.5 mm; 1 mm thick; 2 m long; slotted; according to EN 60715; "Hole width 18 mm	www.wago.com/210-115
	Nr. articol: 210-118 Steel carrier rail; 35 x 15 mm; 2.3 mm thick; 2 m long; unslotted; according to EN 60715	www.wago.com/210-118
	Nr. articol: 210-196 Aluminum carrier rail; 35 x 8.2 mm; 1.6 mm thick; 2 m long; unslotted; similar to EN 60715; silver-colored	www.wago.com/210-196
	Nr. articol: 210-197 Steel carrier rail; 35 x 15 mm; 1.5 mm thick; 2 m long; slotted; similar to EN 60715	www.wago.com/210-197
	Nr. articol: 210-198 Copper carrier rail; 35 x 15 mm; 2.3 mm thick; 2 m long; unslotted; according to EN 60715; copper-colored	www.wago.com/210-198
	Nr. articol: 210-504 Steel carrier rail; 35 x 7.5 mm; 1 mm thick; 2 m long; slotted; galvanized; according to EN 60715	www.wago.com/210-504















Supus modificărilor.

WAGO Kontakttechnik GmbH & Co. KG
/Representative Office Romania
Sos. Pipera-Tunari nr. 1/1
building 1, 2nd floor | 077190 Voluntari, Ilfov
Tel.: +40-(0)31 421 85 68 | Email: info-RO@wago.com

Aveți întrebări despre produsele noastre?
Vă stăm la dispoziție pentru preluarea apelului la +40 (0) 31 421 85 68.

	Nr. articol: 210-505 Steel carrier rail; 35 x 7.5 mm; 1 mm thick; 2 m long; unslotted; galvanized; according to EN 60715	www.wago.com/210-505
	Nr. articol: 210-506 Steel carrier rail; 35 x 15 mm; 1.5 mm thick; 2 m long; unslotted; galvanized; similar to EN 60715	www.wago.com/210-506
	Nr. articol: 210-508 Steel carrier rail; 35 x 15 mm; 1.5 mm thick; 2 m long; slotted; galvanized; similar to EN 60715	www.wago.com/210-508
Jumper		
	Nr. articol: 210-103 Wire commoning chain; insulated; 50 connections; black	www.wago.com/210-103
	Nr. articol: 249-123 Push-in type wire jumper; insulated; wire length 180 mm; Conductor cross section 0.75 mm ²	www.wago.com/249-123
	Nr. articol: 249-125 Push-in type wire jumper; insulated; wire length 60 mm; Conductor cross section 0.75 mm ²	www.wago.com/249-125
	Nr. articol: 249-126 Push-in type wire jumper; insulated; wire length 110 mm; Conductor cross section 0.75 mm ²	www.wago.com/249-126
	Nr. articol: 249-127 Push-in type wire jumper; insulated; wire length 250 mm; Conductor cross section 0.75 mm ²	www.wago.com/249-127
	Nr. articol: 279-482 Comb-style jumper bar; insulated; 2-way; IN = IN terminal block; gray	www.wago.com/279-482
	Nr. articol: 279-483 Comb-style jumper bar; insulated; 3-way; IN = IN terminal block; gray	www.wago.com/279-483
	Nr. articol: 279-490 Comb-style jumper bar; insulated; 10-way; IN = IN terminal block; gray	www.wago.com/279-490
	Nr. articol: 279-492 Alternate comb-style jumper bar; insulated; 2-way; IN = IN terminal block; gray	www.wago.com/279-492
tools		
	Nr. articol: 210-647 Operating tool; Blade: 2.5 x 0.4 mm; with a partially insulated shaft	www.wago.com/210-647
	Nr. articol: 210-648 Operating tool; Blade: 2.5 x 0.4 mm; with a partially insulated shaft; angled; short	www.wago.com/210-648
	Nr. articol: 210-719 Operating tool; Blade: 2.5 x 0.4 mm; with a partially insulated shaft	www.wago.com/210-719
Marking accessories		
	Nr. articol: 2009-114 WMB-Inline; for Smart Printer; 2000 pieces on roll; stretchable 4 - 4.2 mm; plain; snap-on type; white	www.wago.com/2009-114
	Nr. articol: 2009-114/000-002 WMB-Inline; for Smart Printer; 2000 pieces on roll; stretchable 4 - 4.2 mm; plain; snap-on type; yellow	www.wago.com/2009-114/000-002

Supus modificărilor.

	Nr. articol: 2009-114/000-005 WMB-Inline; for Smart Printer; 2000 pieces on roll; stretchable 4 - 4.2 mm; plain; snap-on type; red	www.wago.com/2009-114/000-005
	Nr. articol: 2009-114/000-006 WMB-Inline; for Smart Printer; 2000 pieces on roll; stretchable 4 - 4.2 mm; plain; snap-on type; blue	www.wago.com/2009-114/000-006
	Nr. articol: 2009-114/000-007 WMB-Inline; for Smart Printer; 2000 pieces on roll; stretchable 4 - 4.2 mm; plain; snap-on type; gray	www.wago.com/2009-114/000-007
	Nr. articol: 2009-114/000-012 WMB-Inline; for Smart Printer; 2000 pieces on roll; stretchable 4 - 4.2 mm; plain; snap-on type; orange	www.wago.com/2009-114/000-012
	Nr. articol: 2009-114/000-023 WMB-Inline; for Smart Printer; 2000 pieces on roll; stretchable 4 - 4.2 mm; plain; snap-on type; green	www.wago.com/2009-114/000-023
	Nr. articol: 2009-114/000-024 WMB-Inline; for Smart Printer; 2000 pieces on roll; stretchable 4 - 4.2 mm; plain; snap-on type; violet	www.wago.com/2009-114/000-024
	Nr. articol: 249-105 Group marker carrier; gray	www.wago.com/249-105
	Nr. articol: 793-4501 WMB marking card; as card; stretchable 4 - 4.2 mm; plain; snap-on type; white	www.wago.com/793-4501
	Nr. articol: 793-4501/000-002 WMB marking card; as card; stretchable 4 - 4.2 mm; plain; snap-on type; yellow	www.wago.com/793-4501/000-002
	Nr. articol: 793-4501/000-005 WMB marking card; as card; stretchable 4 - 4.2 mm; plain; snap-on type; red	www.wago.com/793-4501/000-005
	Nr. articol: 793-4501/000-006 WMB marking card; as card; stretchable 4 - 4.2 mm; plain; snap-on type; blue	www.wago.com/793-4501/000-006
	Nr. articol: 793-4501/000-007 WMB marking card; as card; stretchable 4 - 4.2 mm; plain; snap-on type; gray	www.wago.com/793-4501/000-007
	Nr. articol: 793-4501/000-012 WMB marking card; as card; stretchable 4 - 4.2 mm; plain; snap-on type; orange	www.wago.com/793-4501/000-012
	Nr. articol: 793-4501/000-014 WMB marking card; as card; stretchable 4 - 4.2 mm; plain; snap-on type; brown	www.wago.com/793-4501/000-014

Supus modificărilor.



Nr. articol: 793-4501/000-017
WMB marking card; as card; stretchable 4 - 4.2 mm; plain; snap-on type; green

www.wago.com/793-4501/000-017



Nr. articol: 793-4501/000-023
WMB marking card; as card; stretchable 4 - 4.2 mm; plain; snap-on type; light green

www.wago.com/793-4501/000-023



Nr. articol: 793-4501/000-024
WMB marking card; as card; stretchable 4 - 4.2 mm; plain; snap-on type; violet

www.wago.com/793-4501/000-024

Descărcări

Documentation

Additional Information

Technical explanations	Apr 3, 2019	pdf 2,1 MB	Descărcare
------------------------	-------------	---------------	------------

CAD/CAE-Data

CAD data

2D/3D Models 279-809/281-434	URL	Descărcare
------------------------------	-----	------------

CAE data

EPLAN Data Portal 279-809/281-434	URL	Descărcare
-----------------------------------	-----	------------

WSCAD Universe 279-809/281-434	URL	Descărcare
--------------------------------	-----	------------

Installation Notes

Jumpered

Supus modificărilor.

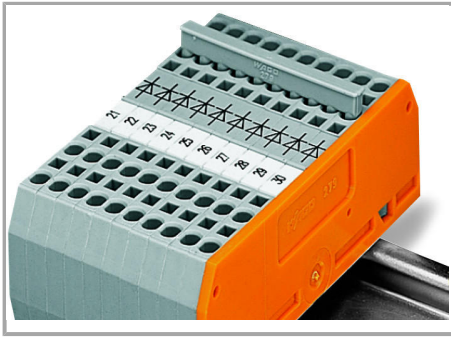

Commoning using comb-style jumper bars.
Push comb-style jumper bars down until fully inserted.

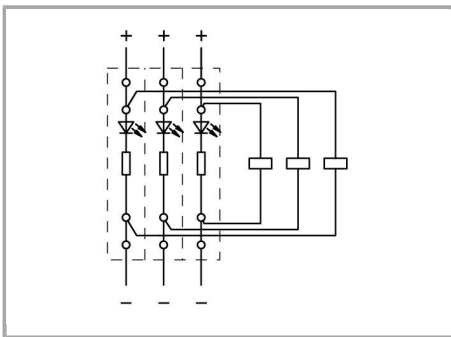

Circuit-related voltage indications can be created using the following terminal blocks:

279-809/281-434 or 279-809/281-413

Supus modificărilor.