

Fișă tehnică | Număr articol: 831-3103/133-000

1-conductor female plug; 100% protected against mismatching; Gripping plate; 10 mm²; Pin spacing 7.62 mm; 3-pole; 10,00 mm²; light gray

www.wago.com/831-3103/133-000

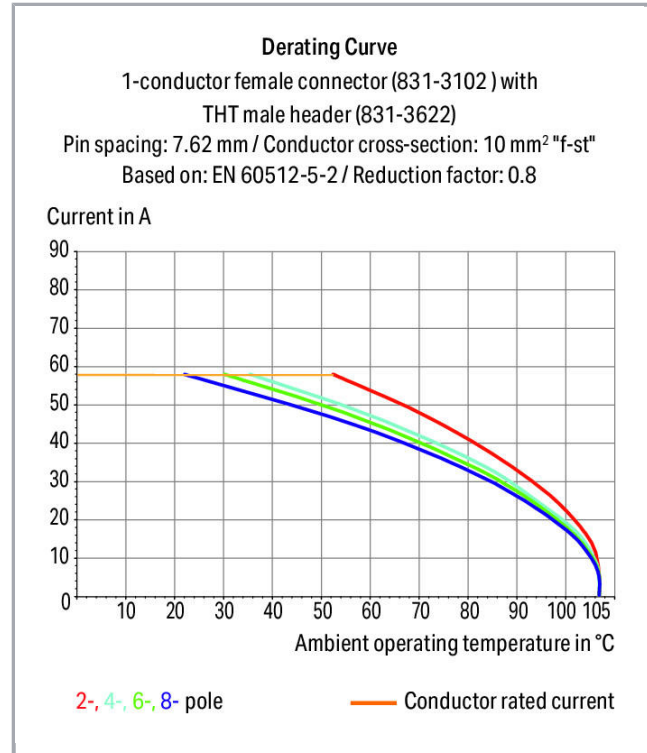
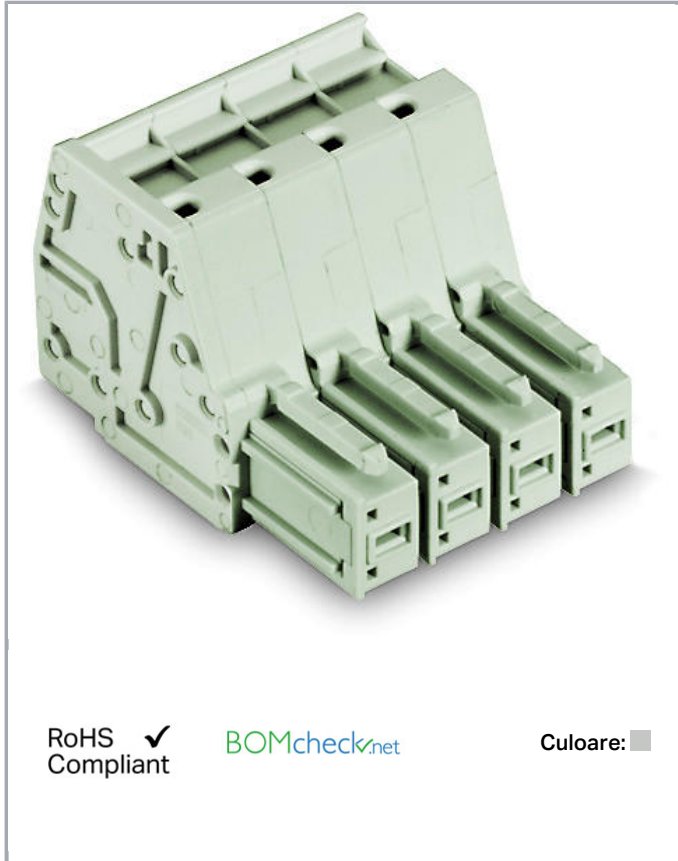

Supus modificărilor.

WAGO Kontakttechnik GmbH & Co. KG
/Representative Office Romania
Sos. Pipera-Tunari nr. 1/1
building 1, 2nd floor | 077190 Voluntari, Ilfov
Tel.: +40-(0)31 421 85 68 | Email: info-RO@wago.com

Aveți întrebări despre produsele noastre?
Vă stăm la dispoziție pentru preluarea apelului la +40 (0) 31 421 85 68.

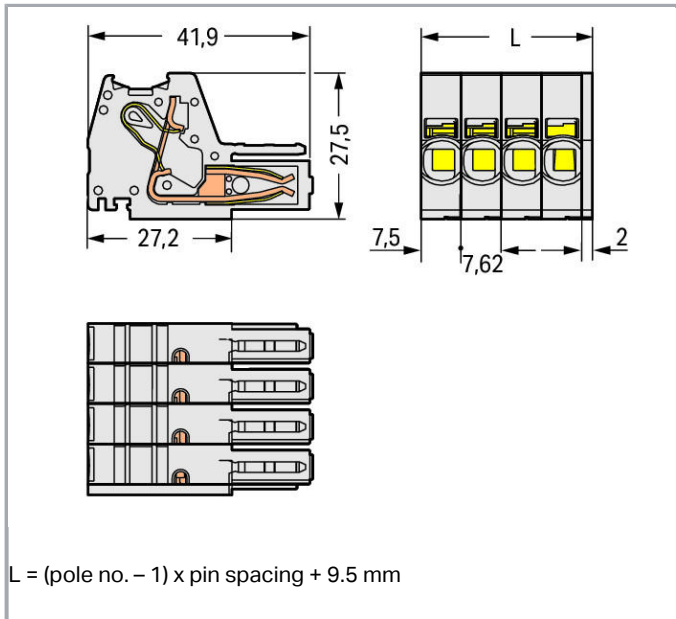

Descriere articol

- Universal connection for all conductor types
- Push-in termination of solid or ferruled conductors
- Integrated test ports for 2 mm Ø test plugs
- 600 V UL per UL 1059
- 100 % protected against mismatching
- Coding via coding fingers

Safety information 1:

The *MULTI CONNECTION SYSTEM (MCS)* is designed without breaking capacity for compliance with DIN EN 61984. When used as intended, MCS Connectors shall not be connected/disconnected when live or under load. The circuit design should ensure header pins, which can be touched, are not live when unmated.

Date

Electrical data

Ratings per IEC/EN 60664-1

Ratings per	IEC/EN 60664-1
Nominal voltage (III/3)	800 V
Rated surge voltage (III/3)	8 kV
Rated voltage (III/2)	1000 V

Supus modificărilor.

WAGO Kontakttechnik GmbH & Co. KG
 /Representative Office Romania
 Sos. Pipera-Tunari nr. 1/1
 building 1, 2nd floor | 077190 Voluntari, Ilfov
 Tel.: +40-(0)31 421 85 68 | Email: info-RO@wago.com

Aveți întrebări despre produsele noastre?
 Vă stăm la dispoziție pentru preluarea apelului la +40 (0) 31 421 85 68.



Rated surge voltage (III/2)	8 kV
Nominal voltage (II/2)	1000 V
Rated surge voltage (II/2)	8 kV
Rated current	41 A
Legend (ratings)	(III / 2) $\hat{=}$ Overvoltage category III / Pollution degree 2

Approvals per UL 1059

Rated voltage UL (Use Group C)	600 V
Rated current UL (Use Group C)	42 A
Approvals per	UL 1059

Approvals per CSA

Rated voltage CSA (Use Group C)	600 V
Rated current CSA (Use Group C)	41 A

Connection data

Connection technology	Push-in CAGE CLAMP [®]
Actuation type	Operating tool
Solid conductor	0,5 ... 10 mm ² / 20 ... 8 AWG
Fine-stranded conductor	0,5 ... 10 mm ² / 20 ... 8 AWG
Fine-stranded conductor; with insulated ferrule	0.5 ... 6 mm ²
Fine-stranded conductor; with uninsulated ferrule	0.5 ... 6 mm ²
Strip length	13 ... 15 mm / 0.51 ... 0.59 inch
Pole No.	3
Total number of connection points	3
Total number of potentials	3
Number of connection types	1
Number of levels	1

Geometrical Data

Pin spacing	7.62 mm / 0.3 inch
Width	24.74 mm / 0.974 inch
Height	27.5 mm / 1.083 inch
Depth	41.9 mm / 1.65 inch

Supus modificărilor.

WAGO Kontakttechnik GmbH & Co. KG
 /Representative Office Romania
 Sos. Pipera-Tunari nr. 1/1
 building 1, 2nd floor | 077190 Voluntari, Ilfov
 Tel.: +40-(0)31 421 85 68 | Email: info-RO@wago.com

Aveți întrebări despre produsele noastre?
 Vă stăm la dispoziție pentru preluarea apelului la +40 (0) 31 421 85 68.

Plug connection

Contact type (pluggable connector)	Female connector/socket
Connector (connection type)	for conductors
Mismatching protection	Yes

Material Data

Color	light gray
Material group	I
Insulation material	Polyamide 66 (PA 66)
Flammability class per UL94	V0
Clamping spring material	Chrome nickel spring steel (CrNi)
Material of the additional spring for socket contact	Chrome nickel spring steel (CrNi)
Contact material	Electrolytic copper (E _{Cu})
Contact plating	tin-plated
Weight	23,9 g

Environmental Requirements

Limit temperature range	-60 ... +105 °C
-------------------------	-----------------

Commercial data

Packaging type	BOX
Country of origin	DE
GTIN	4055143511223
Customs tariff number	85366990990

Aprobări / certificate

Country specific Approvals

Emblemă	Aprobare	Text de aprobare suplimentar	Nume certificat
	KEMA/KEUR DEKRA Certification B.V.	EN 61984	71- 110530

Supus modificărilor.

WAGO Kontakttechnik GmbH & Co. KG
/Representative Office Romania
Sos. Pipera-Tunari nr. 1/1
building 1, 2nd floor | 077190 Voluntari, Ilfov
Tel.: +40-(0)31 421 85 68 | Email: info-RO@wago.com

Aveți întrebări despre produsele noastre?
Vă stăm la dispoziție pentru preluarea apelului la +40 (0) 31 421 85 68.

Counterpart

**Nr. articol**831-32031-conductor male connector; 100% protected against mismatching; 10 mm²; Pin spacing 7.62 mm; 3-pole; 10,00 mm²; light graywww.wago.com/831-3203**Nr. articol**831-3603

THT male header; 1.0 x 1.2 mm solder pin; straight; 100% protected against mismatching; Pin spacing 7.62 mm; 3-pole; light gray

www.wago.com/831-3603**Nr. articol**831-3623

THT male header; 1.0 x 1.2 mm solder pin; angled; 100% protected against mismatching; Pin spacing 7.62 mm; 3-pole; light gray

www.wago.com/831-3623

Produse compatibile

Marking accessories

**Nr. articol:** 2009-110

Marking strips; on reel; not stretchable; plain; snap-on type; white

www.wago.com/2009-110**Nr. articol:** 2009-110/762-802

Marking strips; cut to a defined length; Specialty printing; not stretchable; Horizontal marking; snap-on type; white

www.wago.com/2009-110/762-802**Nr. articol:** 2009-110/762-803

Marking strips; cut to a defined length; Specialty printing; not stretchable; Horizontal marking; snap-on type; white

www.wago.com/2009-110/762-803**Nr. articol:** 2009-110/762-804

Marking strips; cut to a defined length; Specialty printing; not stretchable; Horizontal marking; snap-on type; white

www.wago.com/2009-110/762-804**Nr. articol:** 2009-110/762-805

Marking strips; cut to a defined length; Specialty printing; not stretchable; Horizontal marking; snap-on type; white

www.wago.com/2009-110/762-805**Nr. articol:** 2009-110/762-806















Marking strips; cut to a defined length; Specialty printing; not stretchable; Horizontal marking; snap-on type; white

www.wago.com/2009-110/762-806**Nr. articol:** 2009-110/762-807

Marking strips; cut to a defined length; Specialty printing; not stretchable; Horizontal marking; snap-on type; white

www.wago.com/2009-110/762-807**Nr. articol:** 2009-110/762-808















Supus modificărilor.

	Marking strips; cut to a defined length; Specialty printing; not stretchable; Horizontal marking; snap-on type; white	www.wago.com/2009-110/762-808
	Nr. articol: 2009-115 WMB-Inline; for Smart Printer; 1500 pieces on roll; stretchable 5 - 5.2 mm; plain; snap-on type; white	www.wago.com/2009-115
	Nr. articol: 2009-115/000-002 WMB-Inline; for Smart Printer; 1500 pieces on roll; stretchable 5 - 5.2 mm; plain; snap-on type; yellow	www.wago.com/2009-115/000-002
	Nr. articol: 2009-115/000-006 WMB-Inline; for Smart Printer; 1500 pieces on roll; stretchable 5 - 5.2 mm; plain; snap-on type; blue	www.wago.com/2009-115/000-006
	Nr. articol: 2009-115/000-007 WMB-Inline; for Smart Printer; 1500 pieces on roll; stretchable 5 - 5.2 mm; plain; snap-on type; gray	www.wago.com/2009-115/000-007
	Nr. articol: 2009-115/000-012 WMB-Inline; for Smart Printer; 1500 pieces on roll; stretchable 5 - 5.2 mm; plain; snap-on type; orange	www.wago.com/2009-115/000-012
	Nr. articol: 2009-115/000-017 WMB-Inline; for Smart Printer; 1500 pieces on roll; stretchable 5 - 5.2 mm; plain; snap-on type; light green	www.wago.com/2009-115/000-017
	Nr. articol: 2009-115/000-023 WMB-Inline; for Smart Printer; 1500 pieces on roll; stretchable 5 - 5.2 mm; plain; snap-on type; green	www.wago.com/2009-115/000-023
	Nr. articol: 2009-115/000-024 WMB-Inline; for Smart Printer; 1500 pieces on roll; stretchable 5 - 5.2 mm; plain; snap-on type; violet	www.wago.com/2009-115/000-024
	Nr. articol: 2009-135 WMB-Inline; for Smart Printer; on reel; stretchable 5 - 5.2 mm; plain; snap-on type; white	www.wago.com/2009-135
	Nr. articol: 2009-145 Mini-WSB Inline; for Smart Printer; 1700 pieces on roll; stretchable 5 - 5.2 mm; plain; snap-on type; white	www.wago.com/2009-145
	Nr. articol: 2009-145/000-002 Mini-WSB Inline; for Smart Printer; 1700 pieces on roll; stretchable 5 - 5.2 mm; plain; snap-on type; yellow	www.wago.com/2009-145/000-002
	Nr. articol: 2009-145/000-005 Mini-WSB Inline; for Smart Printer; 1700 pieces on roll; stretchable 5 - 5.2 mm; plain; snap-on type; red	www.wago.com/2009-145/000-005
	Nr. articol: 2009-145/000-006 Mini-WSB Inline; for Smart Printer; 1700 pieces on roll; stretchable 5 - 5.2 mm; plain; snap-on type; blue	www.wago.com/2009-145/000-006

Supus modificărilor.

WAGO Kontakttechnik GmbH & Co. KG
 /Representative Office Romania
 Sos. Pipera-Tunari nr. 1/1
 building 1, 2nd floor | 077190 Voluntari, Ilfov
 Tel.: +40-(0)31 421 85 68 | Email: info-RO@wago.com

Aveți întrebări despre produsele noastre?
 Vă stăm la dispoziție pentru preluarea apelului la +40 (0) 31 421 85 68.

	Nr. articol: 2009-145/000-007 Mini-WSB Inline; for Smart Printer; 1700 pieces on roll; stretchable 5 - 5.2 mm; plain; snap-on type; gray	www.wago.com/2009-145/000-007
	Nr. articol: 2009-145/000-012 Mini-WSB Inline; for Smart Printer; 1700 pieces on roll; stretchable 5 - 5.2 mm; plain; snap-on type; orange	www.wago.com/2009-145/000-012
	Nr. articol: 2009-145/000-023 Mini-WSB Inline; for Smart Printer; 1700 pieces on roll; stretchable 5 - 5.2 mm; plain; snap-on type; green	www.wago.com/2009-145/000-023
	Nr. articol: 2009-145/000-024 Mini-WSB Inline; for Smart Printer; 1700 pieces on roll; stretchable 5 - 5.2 mm; plain; snap-on type; violet	www.wago.com/2009-145/000-024
	Nr. articol: 248-501 Miniature WSB Quick marking system; plain; Marker width 5 mm; 10 strips with 10 markers per card	www.wago.com/248-501
	Nr. articol: 248-501/000-002 Mini-WSB marking card; as card; not stretchable; plain; snap-on type; yellow	www.wago.com/248-501/000-002
	Nr. articol: 248-501/000-005 Mini-WSB marking card; as card; not stretchable; plain; snap-on type; red	www.wago.com/248-501/000-005
	Nr. articol: 248-501/000-006 Mini-WSB marking card; as card; not stretchable; plain; snap-on type; blue	www.wago.com/248-501/000-006
	Nr. articol: 248-501/000-007 Mini-WSB marking card; as card; not stretchable; plain; snap-on type; gray	www.wago.com/248-501/000-007
	Nr. articol: 248-501/000-012 Mini-WSB marking card; as card; not stretchable; plain; snap-on type; orange	www.wago.com/248-501/000-012
	Nr. articol: 248-501/000-017 Mini-WSB marking card; as card; not stretchable; plain; snap-on type; light green	www.wago.com/248-501/000-017
	Nr. articol: 248-501/000-023 Mini-WSB marking card; as card; not stretchable; plain; snap-on type; green	www.wago.com/248-501/000-023
	Nr. articol: 793-501 WMB marking card; as card; not stretchable; plain; snap-on type; white	www.wago.com/793-501
	Nr. articol: 793-501/000-002 WMB marking card; as card; not stretchable; plain; snap-on type; yellow	www.wago.com/793-501/000-002

Supus modificărilor.



Nr. articol: 793-501/000-005
WMB marking card; as card; not stretchable; plain; snap-on type; red

www.wago.com/793-501/000-005



Nr. articol: 793-501/000-006
WMB marking card; as card; not stretchable; plain; snap-on type; blue

www.wago.com/793-501/000-006



Nr. articol: 793-501/000-007
WMB marking card; as card; not stretchable; plain; snap-on type; gray

www.wago.com/793-501/000-007



Nr. articol: 793-501/000-012
WMB marking card; as card; not stretchable; plain; snap-on type; orange

www.wago.com/793-501/000-012



Nr. articol: 793-501/000-017
WMB marking card; as card; not stretchable; plain; snap-on type; light green

www.wago.com/793-501/000-017



Nr. articol: 793-501/000-023
WMB marking card; as card; not stretchable; plain; snap-on type; green

www.wago.com/793-501/000-023



Nr. articol: 793-501/000-024
WMB marking card; as card; not stretchable; plain; snap-on type; violet

www.wago.com/793-501/000-024



Nr. articol: 793-5501
WMB marking card; as card; for terminal block width 5 - 17.5 mm; stretchable 5 - 5.2 mm; plain; snap-on type; white

www.wago.com/793-5501



Nr. articol: 793-5501/000-002
WMB marking card; as card; for terminal block width 5 - 17.5 mm; stretchable 5 - 5.2 mm; plain; snap-on type; yellow

www.wago.com/793-5501/000-002



Nr. articol: 793-5501/000-005
WMB marking card; as card; for terminal block width 5 - 17.5 mm; stretchable 5 - 5.2 mm; plain; snap-on type; red

www.wago.com/793-5501/000-005



Nr. articol: 793-5501/000-006
WMB marking card; as card; for terminal block width 5 - 17.5 mm; stretchable 5 - 5.2 mm; plain; snap-on type; blue

www.wago.com/793-5501/000-006



Nr. articol: 793-5501/000-007
WMB marking card; as card; for terminal block width 5 - 17.5 mm; stretchable 5 - 5.2 mm; plain; snap-on type; gray

www.wago.com/793-5501/000-007



Nr. articol: 793-5501/000-012
WMB marking card; as card; for terminal block width 5 - 17.5 mm; stretchable 5 - 5.2 mm; plain; snap-on type; orange

www.wago.com/793-5501/000-012

Nr. articol: 793-5501/000-017

Supus modificărilor.



WMB marking card; as card; for terminal block width 5 - 17.5 mm; stretchable 5 - 5.2 mm; plain; snap-on type; green

www.wago.com/793-5501/000-017



Nr. articol: 793-5501/000-023

WMB marking card; as card; for terminal block width 5 - 17.5 mm; stretchable 5 - 5.2 mm; plain; snap-on type; light green

www.wago.com/793-5501/000-023



Nr. articol: 793-5501/000-024

WMB marking card; as card; for terminal block width 5 - 17.5 mm; stretchable 5 - 5.2 mm; plain; snap-on type; violet

www.wago.com/793-5501/000-024

ferrule



Nr. articol: 216-101

Ferrule; Sleeve for 0.5 mm² / AWG 22; uninsulated; electro-tin plated

www.wago.com/216-101



Nr. articol: 216-102

Ferrule; Sleeve for 0.75 mm² / AWG 20; uninsulated; electro-tin plated

www.wago.com/216-102



Nr. articol: 216-103

Ferrule; Sleeve for 1 mm² / AWG 18; uninsulated; electro-tin plated

www.wago.com/216-103



Nr. articol: 216-104

Ferrule; Sleeve for 1.5 mm² / AWG 16; uninsulated; electro-tin plated

www.wago.com/216-104



Nr. articol: 216-106

Ferrule; Sleeve for 2.5 mm² / AWG 14; uninsulated; electro-tin plated

www.wago.com/216-106



Nr. articol: 216-107

Ferrule; Sleeve for 4 mm² / AWG 12; uninsulated; electro-tin plated

www.wago.com/216-107



Nr. articol: 216-108

Ferrule; Sleeve for 6 mm² / AWG 10; uninsulated; electro-tin plated

www.wago.com/216-108



Nr. articol: 216-121

Ferrule; Sleeve for 0.5 mm² / AWG 22; uninsulated; electro-tin plated

www.wago.com/216-121



Nr. articol: 216-122

Ferrule; Sleeve for 0.75 mm² / AWG 20; uninsulated; electro-tin plated

www.wago.com/216-122



Nr. articol: 216-123

Ferrule; Sleeve for 1 mm² / AWG 18; uninsulated; electro-tin plated

www.wago.com/216-123



Nr. articol: 216-124

Ferrule; Sleeve for 1.5 mm² / AWG 16; uninsulated; electro-tin plated

www.wago.com/216-124



Nr. articol: 216-131

Ferrule; Sleeve for 0.25 mm² / AWG 24; uninsulated; electro-tin plated

www.wago.com/216-131



Nr. articol: 216-132

Ferrule; Sleeve for 0.34 mm² / AWG 24; uninsulated; electro-tin plated

www.wago.com/216-132

Nr. articol: 216-141

















Ferrule; Sleeve for 0.5 mm² / 20 AWG; uninsulated; electro-tin plated; electrolytic copper; gastight

www.wago.com/216-141

Supus modificărilor.

WAGO Kontakttechnik GmbH & Co. KG
/Representative Office Romania
Sos. Pipera-Tunari nr. 1/1
building 1, 2nd floor | 077190 Voluntari, Ilfov
Tel.: +40-(0)31 421 85 68 | Email: info-RO@wago.com

Aveți întrebări despre produsele noastre?
Vă stăm la dispoziție pentru preluarea apelului la +40 (0) 31 421 85 68.

	crimped; acc. to DIN 46228, Part 1/08.92	
	Nr. articol: 216-142 Ferrule; Sleeve for 0.75 mm ² / 18 AWG; uninsulated; electro-tin plated; electrolytic copper; gastight crimped; acc. to DIN 46228, Part 1/08.92	www.wago.com/216-142
	Nr. articol: 216-143 Ferrule; Sleeve for 1 mm ² / AWG 18; uninsulated; electro-tin plated; electrolytic copper; gastight crimped; acc. to DIN 46228, Part 1/08.92	www.wago.com/216-143
	Nr. articol: 216-144 Ferrule; Sleeve for 1.5 mm ² / AWG 16; uninsulated; electro-tin plated; electrolytic copper; gastight crimped; acc. to DIN 46228, Part 1/08.92	www.wago.com/216-144
	Nr. articol: 216-151 Ferrule; Sleeve for 0.25 mm ² / AWG 24; uninsulated; electro-tin plated	www.wago.com/216-151
	Nr. articol: 216-152 Ferrule; Sleeve for 0.34 mm ² / AWG 24; uninsulated; electro-tin plated	www.wago.com/216-152
	Nr. articol: 216-201 Ferrule; Sleeve for 0.5 mm ² / 20 AWG; insulated; electro-tin plated; white	www.wago.com/216-201
	Nr. articol: 216-202 Ferrule; Sleeve for 0.75 mm ² / 18 AWG; insulated; electro-tin plated; gray	www.wago.com/216-202
	Nr. articol: 216-203 Ferrule; Sleeve for 1 mm ² / AWG 18; insulated; electro-tin plated; red	www.wago.com/216-203
	Nr. articol: 216-204 Ferrule; Sleeve for 1.5 mm ² / AWG 16; insulated; electro-tin plated; black	www.wago.com/216-204
	Nr. articol: 216-205 Ferrule; Sleeve for 2.08 mm ² / AWG 14; insulated; electro-tin plated; yellow	www.wago.com/216-205
	Nr. articol: 216-206 Ferrule; Sleeve for 2.5 mm ² / AWG 14; insulated; electro-tin plated; blue	www.wago.com/216-206
	Nr. articol: 216-207 Ferrule; Sleeve for 4 mm ² / AWG 12; insulated; electro-tin plated; gray	www.wago.com/216-207
	Nr. articol: 216-208 Ferrule; Sleeve for 6 mm ² / AWG 10; insulated; electro-tin plated; electrolytic copper; gastight crimped; acc. to DIN 46228, Part 4/09.90; yellow	www.wago.com/216-208
	Nr. articol: 216-221 Ferrule; Sleeve for 0.5 mm ² / 20 AWG; insulated; electro-tin plated; white	www.wago.com/216-221
	Nr. articol: 216-222 Ferrule; Sleeve for 0.75 mm ² / 18 AWG; insulated; electro-tin plated; gray	www.wago.com/216-222
	Nr. articol: 216-223 Ferrule; Sleeve for 1 mm ² / AWG 18; insulated; electro-tin plated; red	www.wago.com/216-223
	Nr. articol: 216-224 Ferrule; Sleeve for 1.5 mm ² / AWG 16; insulated; electro-tin plated; black	www.wago.com/216-224

Supus modificărilor.

**Nr. articol: 216-241**

Ferrule; Sleeve for 0.5 mm² / 20 AWG; insulated; electro-tin plated; electrolytic copper; gastight crimped; acc. to DIN 46228, Part 4/09.90; white

www.wago.com/216-241**Nr. articol: 216-242**

Ferrule; Sleeve for 0.75 mm² / 18 AWG; insulated; electro-tin plated; electrolytic copper; gastight crimped; acc. to DIN 46228, Part 4/09.90; gray

www.wago.com/216-242**Nr. articol: 216-243**

Ferrule; Sleeve for 1 mm² / AWG 18; insulated; electro-tin plated; electrolytic copper; gastight crimped; acc. to DIN 46228, Part 4/09.90; red

www.wago.com/216-243**Nr. articol: 216-244**

Ferrule; Sleeve for 1.5 mm² / AWG 16; insulated; electro-tin plated; electrolytic copper; gastight crimped; acc. to DIN 46228, Part 4/09.90; black

www.wago.com/216-244**Nr. articol: 216-246**

Ferrule; Sleeve for 2.5 mm² / AWG 14; insulated; electro-tin plated; electrolytic copper; gastight crimped; acc. to DIN 46228, Part 4/09.90; blue

www.wago.com/216-246**Nr. articol: 216-262**

Ferrule; Sleeve for 0.75 mm² / 18 AWG; insulated; electro-tin plated; electrolytic copper; gastight crimped; acc. to DIN 46228, Part 4/09.90; gray

www.wago.com/216-262**Nr. articol: 216-263**

Ferrule; Sleeve for 1 mm² / AWG 18; insulated; electro-tin plated; electrolytic copper; gastight crimped; acc. to DIN 46228, Part 4/09.90; red

www.wago.com/216-263**Nr. articol: 216-264**

Ferrule; Sleeve for 1.5 mm² / AWG 16; insulated; electro-tin plated; electrolytic copper; gastight crimped; acc. to DIN 46228, Part 4/09.90; black

www.wago.com/216-264**Nr. articol: 216-266**

Ferrule; Sleeve for 2.5 mm² / AWG 14; insulated; electro-tin plated; electrolytic copper; gastight crimped; acc. to DIN 46228, Part 4/09.90; blue

www.wago.com/216-266**Nr. articol: 216-267**

Ferrule; Sleeve for 4 mm² / AWG 12; insulated; electro-tin plated; electrolytic copper; gastight crimped; acc. to DIN 46228, Part 4/09.90; gray

www.wago.com/216-267**Nr. articol: 216-284**

Ferrule; Sleeve for 1.5 mm² / AWG 16; insulated; electro-tin plated; electrolytic copper; gastight crimped; acc. to DIN 46228, Part 4/09.90; black

www.wago.com/216-284**Nr. articol: 216-286**

Ferrule; Sleeve for 2.5 mm² / AWG 14; insulated; electro-tin plated; electrolytic copper; gastight crimped; acc. to DIN 46228, Part 4/09.90; blue

www.wago.com/216-286**Nr. articol: 216-287**

Ferrule; Sleeve for 4 mm² / AWG 12; insulated; electro-tin plated; electrolytic copper; gastight crimped; acc. to DIN 46228, Part 4/09.90; gray

www.wago.com/216-287**Nr. articol: 216-288**

Ferrule; Sleeve for 6 mm² / AWG 10; insulated; electro-tin plated; electrolytic copper; gastight crimped; acc. to DIN 46228, Part 4/09.90; yellow

www.wago.com/216-288**tools****Nr. articol: 210-721**

Operating tool; Blade: 5.5 x 0.8 mm; with a partially insulated shaft

www.wago.com/210-721

Supus modificărilor.

WAGO Kontakttechnik GmbH & Co. KG

/Representative Office Romania

Sos. Pipera-Tunari nr. 1/1

building 1, 2nd floor | 077190 Voluntari, Ilfov

Tel.: +40-(0)31 421 85 68 | Email: info-RO@wago.com

Aveți întrebări despre produsele noastre?

Vă stăm la dispoziție pentru preluarea apelului la +40 (0) 31 421 85 68.



check



Nr. articol: 210-136

Test plug; 2 mm Ø; with 500 mm cable; red

www.wago.com/210-136

Descărcări

Documentation

Additional Information

Technical explanations

Apr 3, 2019

pdf
3,6 MB

Descărcare

Installation Notes

Inserting a conductor

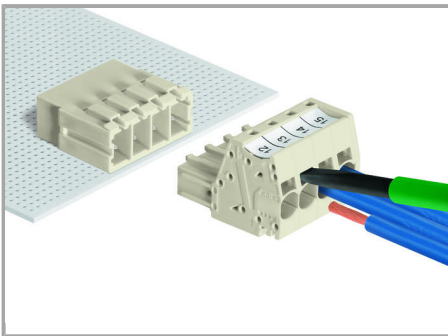

Inserting fine-stranded conductors via (5.5 x 0.8) mm screwdriver.

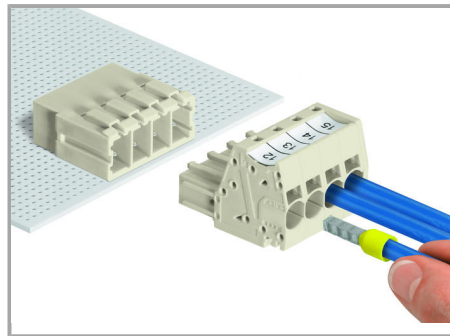

Inserting solid and ferruled conductors via push-in termination.

Testing

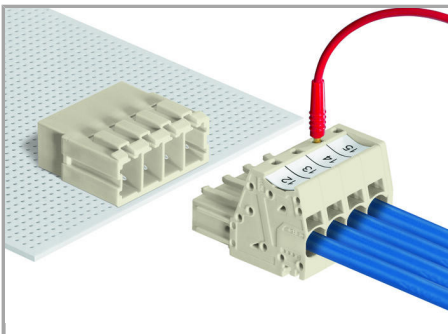

Testing with 2 mm Ø test plug.

Supus modificărilor.

WAGO Kontakttechnik GmbH & Co. KG
/Representative Office Romania
Sos. Pipera-Tunari nr. 1/1
building 1, 2nd floor | 077190 Voluntari, Ilfov
Tel.: +40-(0)31 421 85 68 | Email: info-RO@wago.com

Aveți întrebări despre produsele noastre?
Vă stăm la dispoziție pentru preluarea apelului la +40 (0) 31 421 85 68.

Coding

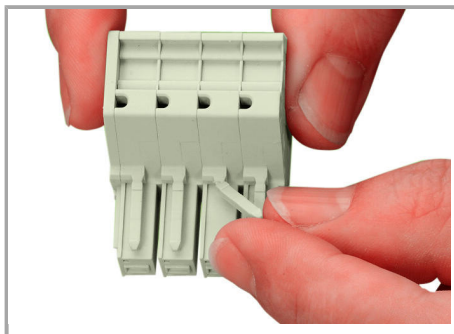

Break or cut off coding pin from female connector.

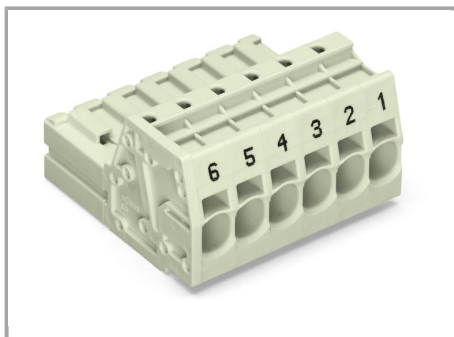

Familie de produse

<i>MCS</i> MAXI 6

[Afișare globală produse din familie.](#)

Supus modificărilor.