

## Descriere articol

- Protected against mismatching and maintenance-free
- Push-in CAGE CLAMP® spring pressure connection technology allows solid conductors to be simply pushed into a unit
- Two-wire connection per pole for loops or bridges
- Additional variable coding is possible
- Components can be clearly printed on and color-coded to meet custom requirements

### Note:

All connectors for mounted installations (snap-in versions for lighting fixtures or devices, all types of PCB and distribution connectors) are factory-equipped with locking levers to ensure plugs and sockets are securely locked. Additional locking levers are only required for flying leads (plug /socket).

### Note on mismatching protection:

All WINSTA® components are 100% protected against mismatching when:

- a.) plugging different numbers of poles
- b.) plugging while rotated 180
- c.) plugging while laterally staggered
- d.) plugging one pole

### Safety information 1:

Supus modificărilor.



Application note for the U.S. market (USR): Some versions may also be used for current interruption in accordance with the UL certificate in select applications with currents below 16 A and voltages up to 600 V. For further information, please contact your local sales office.

## Date

### Electrical data

Note on Contact Resistance	approx. 1 mΩ of contact resistance approx. 0.25 mΩ contact transition plug/socket
----------------------------	---

### Ratings per IEC/EN 60664-1

Ratings per	IEC/EN 60664-1
Nominal voltage (III/3)	400 V
Rated surge voltage (III/3)	6 kV
Rated current	25 A
Legend (ratings)	(III / 3) ≙ Overvoltage category III / Pollution degree 3

### Approvals per UL 1977

Rated voltage UL 1977	600 V
Rated current UL 1977	23 A

### Connection data

Connection technology	Push-in CAGE CLAMP®
Actuation type	Operating tool Push-in
Nominal cross-section	4 mm <sup>2</sup>
Solid conductor	0,5 ... 4 mm <sup>2</sup> / 20 ... 12 AWG
Solid conductor; push-in termination	1,5 ... 4 mm <sup>2</sup> / 16 ... 12 AWG
Stranded conductor	0,5 ... 2,5 mm <sup>2</sup> / 20 ... 14 AWG
Fine-stranded conductor	0,5 ... 4 mm <sup>2</sup> / 20 ... 12 AWG
Fine-stranded conductor; with insulated ferrule	0,25 ... 1,5 mm <sup>2</sup> / 20 ... 16 AWG
Fine-stranded conductor; with uninsulated ferrule	0,25 ... 2,5 mm <sup>2</sup> / 20 ... 14 AWG
Fine-stranded conductor; with ferrule; push-in termination	1,5 mm <sup>2</sup> / 16 AWG
Strip length	9 mm / 0.35 inch
Note (strip length)	see also packaging or instructions
Pole No.	5
Total number of connection points	10
Total number of potentials	5
Conductor entry direction to mating direction	0°

Supus modificărilor.

WAGO Kontakttechnik GmbH & Co. KG  
/Representative Office Romania  
Sos. Pipera-Tunari nr. 1/1  
building 1, 2nd floor | 077190 Voluntari, Ilfov  
Tel.: +40-(0)31 421 85 68 | Email: info-RO@wago.com

Aveți întrebări despre produsele noastre?  
Vă stăm la dispoziție pentru preluarea apelului la +40 (0) 31 421 85 68.



## Geometrical Data

Pin spacing	10 mm / 0.394 inch
Width	50 mm / 1.969 inch
Height	12,9 mm / 0.508 inch
Depth	37,5 mm / 1.476 inch

## Mechanical data

Coding	B
Mating force of a plug-in connection	approx. 20 ... 70 N (depending on pole number)
Retention force of a plug-in connection	Locked: > 80 N
Unmating force of a plug-in connection	Unlocked: approx. 20 ... 70 N (depending on pole number)
Number of mating cycles	200, without resistive load 100, with resistive load $I_N = 25$ A, tested (4 mm <sup>2</sup> /AWG 12)
Marking	N L - +
Protection type	IP20
Note on protection type	In mated condition with strain relief housing: IP2xC (These compact connectors are not designed for use in open, easily accessible areas.)
Potential marking	N L - +

## Plug connection

Contact type (pluggable connector)	Male connector/plug
Connector (connection type)	for conductor
Mismating protection	Yes
Locking of plug-in connection	locking lever
Locking lever	retrofitable

## Material Data

Color	pink
Insulation material	Polyamide 66 (PA 66)
Clamping spring material	Chrome nickel spring steel (CrNi)
Contact material	Copper or copper alloy (surface-treated)
Fire load	0,324 MJ

Supus modificărilor.

WAGO Kontakttechnik GmbH & Co. KG  
/Representative Office Romania  
Sos. Pipera-Tunari nr. 1/1  
building 1, 2nd floor | 077190 Voluntari, Ilfov  
Tel.: +40-(0)31 421 85 68 | Email: info-RO@wago.com

Aveți întrebări despre produsele noastre?  
Vă stăm la dispoziție pentru preluarea apelului la +40 (0) 31 421 85 68.

Weight	16,6g
--------	-------

## Environmental Requirements

Processing temperature	-5 ... +40 °C
Continuous operating temperature	-35 ... +85 °C
Note on continuous operating temperature	Insulating parts for temperatures ≤ 105 °C

## Commercial data

Packaging type	BOX
Country of origin	DE
GTIN	4050821553953
Customs tariff number	85366990990

## Aprobări / certificate

### UL-Approvals

Emblemă	Aprobare	Text de aprobare suplimentar	Nume certificat
	cURus Underwriters Laboratories Inc.	UL 1977	E45171 Sec. 9

## Counterpart



Nr. articol 770-785/082-000  
Snap-in socket; 5-pole; Cod. B; 4,00 mm<sup>2</sup>; pink

[www.wago.com/770-785/082-000](http://www.wago.com/770-785/082-000)



Nr. articol 770-285/082-000  
Socket; 5-pole; Cod. B; 4,00 mm<sup>2</sup>; pink

[www.wago.com/770-285/082-000](http://www.wago.com/770-285/082-000)



Nr. articol 770-885/011-000/082-000  
Socket for PCBs; angled; 5-pole; Cod. B; pink

[www.wago.com/770-885/011-000/082-000](http://www.wago.com/770-885/011-000/082-000)



Nr. articol 770-885/082-000  
Socket for PCBs; straight; 5-pole; Cod. B; pink

[www.wago.com/770-885/082-000](http://www.wago.com/770-885/082-000)

## Produse compatibile

Supus modificărilor.

WAGO Kontakttechnik GmbH & Co. KG  
/Representative Office Romania  
Sos. Pipera-Tunari nr. 1/1  
building 1, 2nd floor | 077190 Voluntari, Ilfov  
Tel.: +40-(0)31 421 85 68 | Email: info-RO@wago.com

Aveți întrebări despre produsele noastre?  
Vă stăm la dispoziție pentru preluarea apelului la +40 (0) 31 421 85 68.

## tools

**Nr. articol: 210-719**

Operating tool; Blade: 2.5 x 0.4 mm; with a partially insulated shaft

[www.wago.com/210-719](http://www.wago.com/210-719)

## Marking accessories

**Nr. articol: 770-450**

Marker card; Plastic; white

[www.wago.com/770-450](http://www.wago.com/770-450)**Nr. articol: 770-450/000-001**

Marker card; Plastic; white

[www.wago.com/770-450/000-001](http://www.wago.com/770-450/000-001)**Nr. articol: 770-450/000-002**

Marker card; Plastic; white

[www.wago.com/770-450/000-002](http://www.wago.com/770-450/000-002)**Nr. articol: 770-450/000-005**

Marker card; Plastic; white

[www.wago.com/770-450/000-005](http://www.wago.com/770-450/000-005)**Nr. articol: 770-450/000-006**

Marker card; Plastic; white

[www.wago.com/770-450/000-006](http://www.wago.com/770-450/000-006)**Nr. articol: 770-450/000-012**

Marker card; Plastic; white

[www.wago.com/770-450/000-012](http://www.wago.com/770-450/000-012)

## Strain relief plate

**Nr. articol: 770-505/021-000**

Strain relief housing; 5-pole; for 1 cable; 11.5 ... 16.5 mm; 71 mm; black

[www.wago.com/770-505/021-000](http://www.wago.com/770-505/021-000)**Nr. articol: 770-505/023-000**

Strain relief housing; 5-pole; for 2 cables; 5.0 ... 9.0 mm; 55 mm; black

[www.wago.com/770-505/023-000](http://www.wago.com/770-505/023-000)**Nr. articol: 770-515/021-000**

Strain relief housing; 5-pole; for 1 cable; 11.5 ... 16.5 mm; 71 mm; white

[www.wago.com/770-515/021-000](http://www.wago.com/770-515/021-000)**Nr. articol: 770-515/023-000**

Strain relief housing; 5-pole; for 2 cables; 5.0 ... 9.0 mm; 55 mm; white

[www.wago.com/770-515/023-000](http://www.wago.com/770-515/023-000)

## Coding

**Nr. articol: 770-401**

Coding pin; for plugs; Plastic; gray

[www.wago.com/770-401](http://www.wago.com/770-401)

Supus modificărilor.

## Descărcări CAD/CAE-Data

### CAD data

2D/3D Models 770-295/082-000

[URL](#)

[Descărcare](#)

### CAE data

WSCAD Universe 770-295/082-000

[URL](#)

[Descărcare](#)

## Installation Notes

### Conductor termination

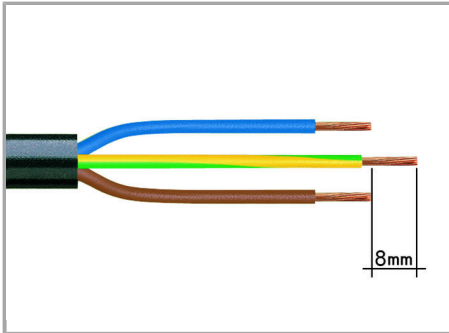

1. Strip length, outer insulation = 35 mm (2-pole), 55 mm (3- to 5-pole)

2. Strip length = 9 mm

3. Extended ground conductor = 8 mm

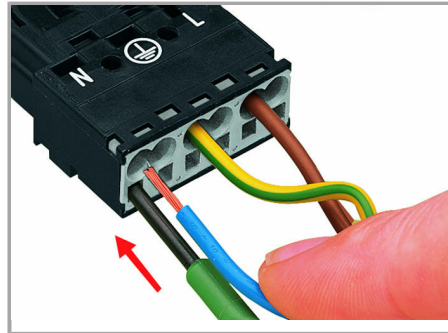

To terminate fine-stranded conductors, open the clamping unit via screwdriver (2.5 mm blade width) and insert stripped conductor until it hits backstop.

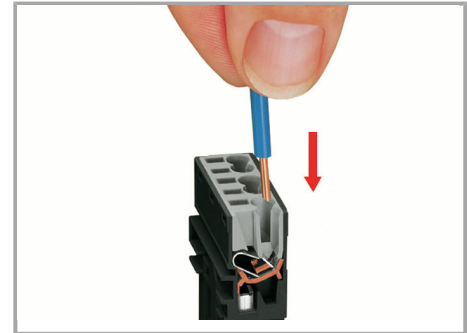

Insert stripped solid conductor until it hits backstop.

Supus modificărilor.



To terminate fine-stranded conductors, open the clamping unit via screwdriver (2.5 mm blade width) and insert stripped conductor until it hits backstop.

#### Conductor removal

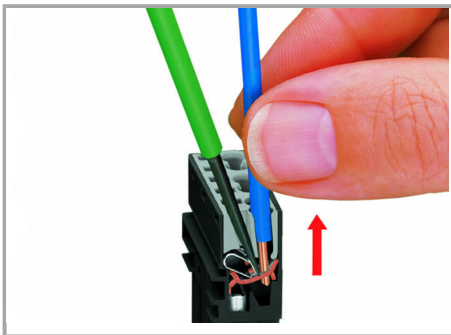

To remove the conductor, actuate the clamp via screwdriver (2.5 mm blade width) and pull out the conductor.

#### Installation

Supus modificărilor.

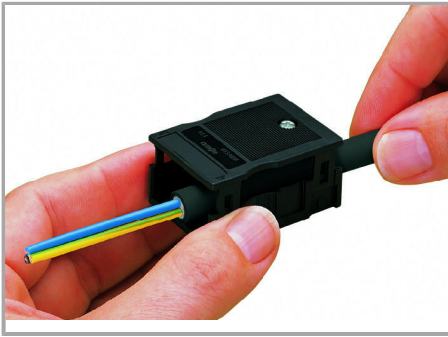

We recommend pulling the pre-latched strain relief housing over the cable prior to termination. However, the strain relief can be mounted at a later time as well.

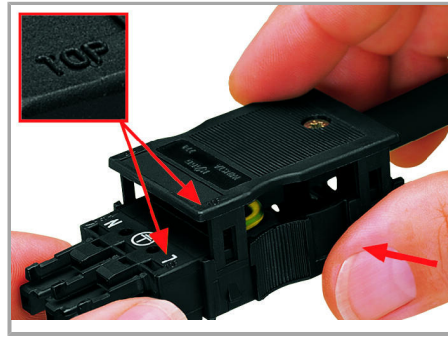

Latch the strain relief housing on the plug /socket. Note the "TOP" inscription.

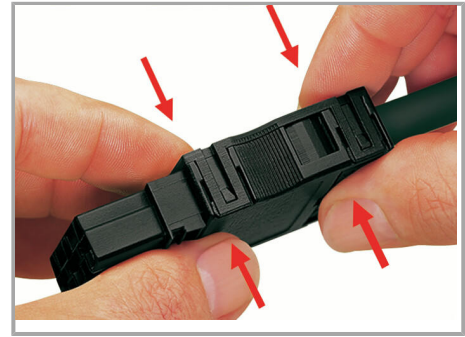

Prepare strain relief housing by snapping together upper and bottom part.



Tighten strain relief screw via screwdriver (2.5 mm blade width).

### Coding

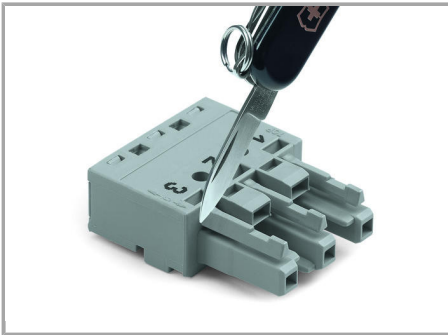

Simply cut off the coding pin from the socket.

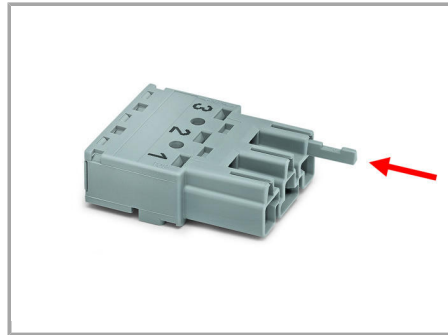

Insert coding pin into plug (break first) until it engages.

### Mismatching protection

Supus modificărilor.



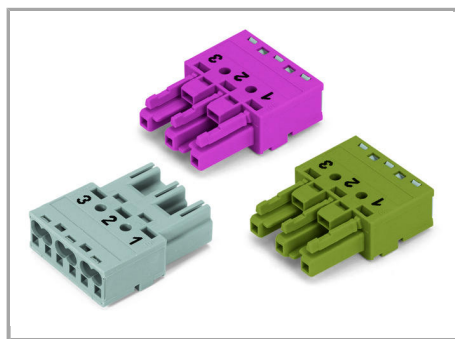

B-coded connectors with different colors can be plugged together.

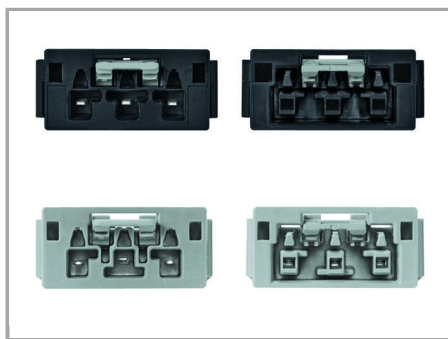

B-coded connectors (shown in gray) not only differ in color, but also in their design, making them incompatible with other coded connectors.

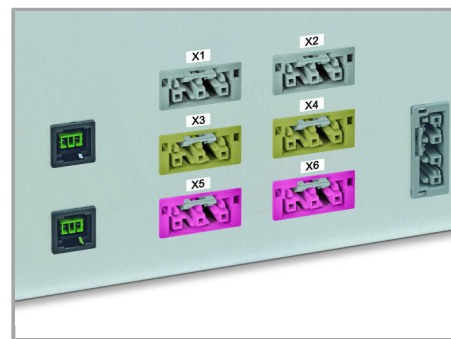

Easy circuit identification via different marking and colors

**Important note:**

Different colors and/or pole marking are used for circuit identification.

Only connectors of the same color and same pole marking must be plugged together.

**Familie de produse**

**<i>WINSTA</i>® MIDI special**

Afișare globală produse din familie.

Supus modificărilor.