

Fișă tehnică | Număr articol: 2002-2201/097-000

Double-deck terminal block; with gray separator; L; oversized; contact inserts only on upper deck; for DIN-rail 35 x 15 and 35 x 7.5; 2.5 mm²; Push-in CAGE CLAMP®; 2,50 mm²; gray

www.wago.com/2002-2201/097-000

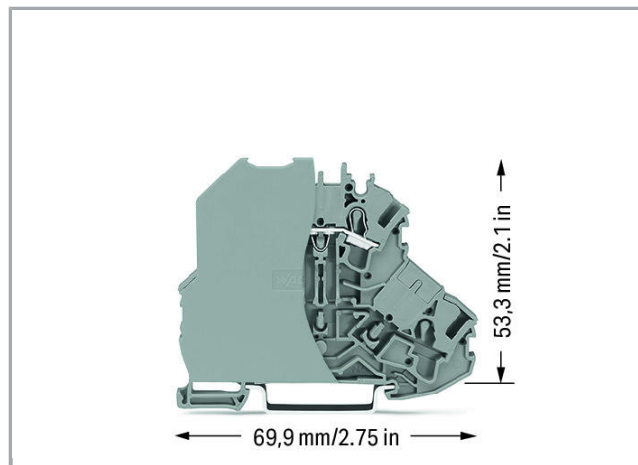
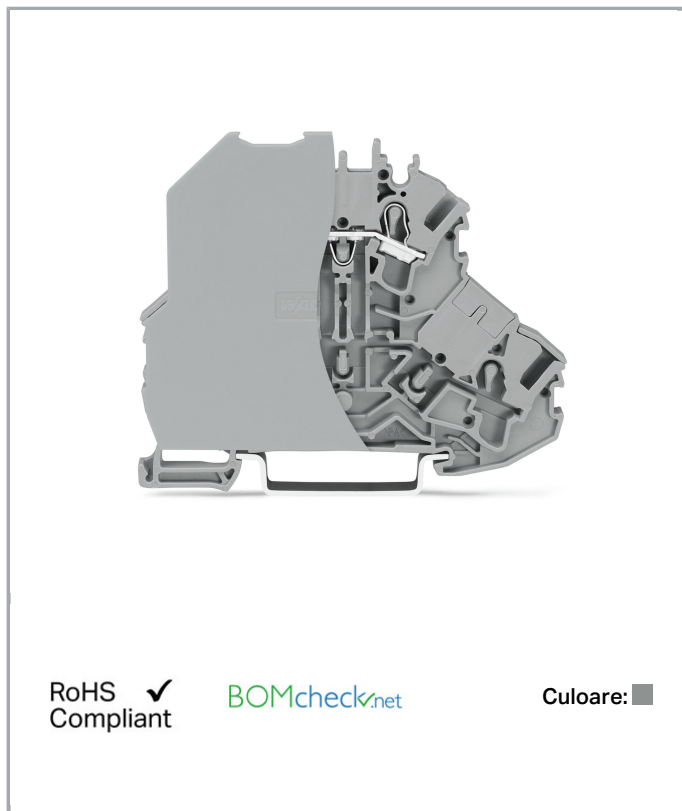

Supus modificărilor.

WAGO Kontakttechnik GmbH & Co. KG
/Representative Office Romania
Sos. Pipera-Tunari nr. 1/1
building 1, 2nd floor | 077190 Voluntari, Ilfov
Tel.: +40-(0)31 421 85 68 | Email: info-RO@wago.com

Aveți întrebări despre produsele noastre?
Vă stăm la dispoziție pentru preluarea apelului la +40 (0) 31 421 85 68.

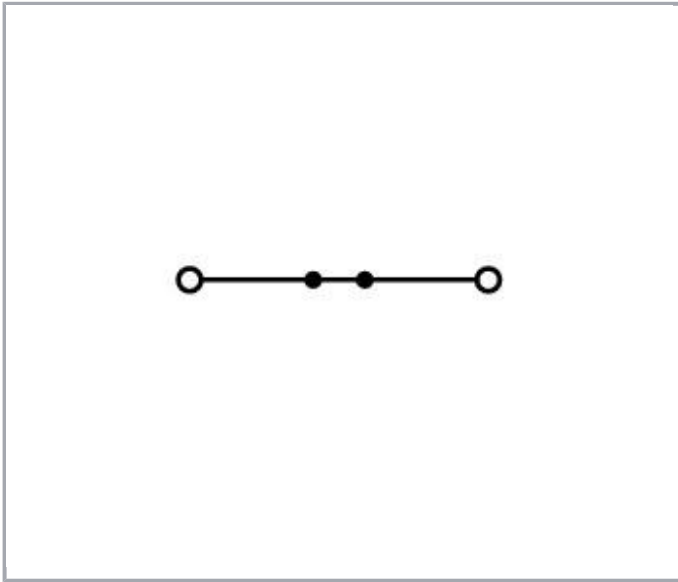
**Date****Electrical data**

Voltage type 1	AC/DC
Voltage type 2	DC

Ratings per IEC/EN 60664-1

Ratings per	IEC/EN 60947-7-1
Nominal voltage (III/3)	1000 V
Rated surge voltage (III/3)	12 kV
Rated current	24 A
Rated voltage (III/3) 2	1500 V
Rated surge voltage (III/3) 2	12 kV
Legend (ratings)	(III / 3) $\hat{=}$ Overvoltage category III / Pollution degree 3

Connection data

Connection technology	Push-in CAGE CLAMP [®]
Actuation type	Push-in Open Tool Slot
Connectable conductor materials	Copper
Nominal cross-section	2,5 mm ²
Solid conductor	0,25 ... 4 mm ² / 22 ... 12 AWG
Solid conductor; push-in termination	0,75 ... 4 mm ² / 18 ... 12 AWG

Supus modificărilor.

WAGO Kontakttechnik GmbH & Co. KG
 /Representative Office Romania
 Sos. Pipera-Tunari nr. 1/1
 building 1, 2nd floor | 077190 Voluntari, Ilfov
 Tel.: +40-(0)31 421 85 68 | Email: info-RO@wago.com

Aveți întrebări despre produsele noastre?
 Vă stăm la dispoziție pentru preluarea apelului la +40 (0) 31 421 85 68.



Fine-stranded conductor	0,25 ... 4 mm ² / 22 ... 12 AWG
Fine-stranded conductor; with insulated ferrule	1 ... 2,5 mm ² / 18 ... 12 AWG
Fine-stranded conductor; with ferrule; push-in termination	1 ... 2,5 mm ² / 18 ... 12 AWG
Strip length	10 ... 12 mm / 0.39 ... 0.47 inch
Total number of connection points	2
Total number of potentials	1
Number of levels	2
Wiring type	Front-entry wiring
Note (conductor cross-section)	Depending on the conductor characteristic, a conductor with a smaller cross-section can also be inserted via push-in termination.

Geometrical Data

Width	7,2 mm / 0.283 inch
Height from upper-edge of DIN-rail	53,3 mm / 2.098 inch
Depth	69,9 mm / 2.752 inch

Mechanical data

Design	horizontal type
Mounting type	DIN-35 rail
Potential marking	L
Marking level	Center/side marking

Material Data

Color	gray
Insulation material	Polyamide 66 (PA 66)
Weight	13,2 g

Commercial data

Packaging type	BOX
Country of origin	DE
GTIN	4055143420242
Customs tariff number	85369010000

Aprobări / certificate

Country specific Approvals

Emblemă	Aprobare	Text de aprobare suplimentar	Nume certificat
---------	----------	------------------------------	-----------------

Supus modificărilor.



WAGO Kontakttechnik GmbH & Co. KG
 /Representative Office Romania
 Sos. Pipera-Tunari nr. 1/1
 building 1, 2nd floor | 077190 Voluntari, Ilfov
 Tel.: +40-(0)31 421 85 68 | Email: info-RO@wago.com

Aveți întrebări despre produsele noastre?
 Vă stăm la dispoziție pentru preluarea apelului la +40 (0) 31 421 85 68.

	CCA DEKRA Certification B.V.	EN 60947	NTR NL 7730
--	---------------------------------	----------	----------------

	KEMA/KEUR DEKRA Certification B.V.	EN 60947	71- 107687
--	---------------------------------------	----------	---------------

Ship Approvals

Emblemă	Aprobare	Text de aprobare suplimentar	Nume certificat
	ABS American Bureau of Shipping	EN 60947	20- HG1941090- PDA
	DNV GL Det Norske Veritas, Germanischer Lloyd	-	TAE00001V2

UL-Approvals

Emblemă	Aprobare	Text de aprobare suplimentar	Nume certificat
	cURus Underwriters Laboratories Inc.	UL 1059	E45172

Counterpart















Produse compatibile

Insulation stop

















Supus modificărilor.

WAGO Kontakttechnik GmbH & Co. KG
/Representative Office Romania
Sos. Pipera-Tunari nr. 1/1
building 1, 2nd floor | 077190 Voluntari, Ilfov
Tel.: +40-(0)31 421 85 68 | Email: info-RO@wago.com

Aveți întrebări despre produsele noastre?
Vă stăm la dispoziție pentru preluarea apelului la +40 (0) 31 421 85 68.

	Nr. articol: 2002-171 Insulation stop; 0.25 - 0.5 mm ² ; 5 pieces/strip; light gray	www.wago.com/2002-171
	Nr. articol: 2002-172 Insulation stop; 0.75 - 1 mm ² ; 5 pieces/strip; dark gray	www.wago.com/2002-172
Push-In type wire jumper		
	Nr. articol: 2009-412 Push-in type wire jumper; insulated; wire length 60 mm; Conductor cross section 1.5 mm ² ; suitable for 2001, 2002, 2003 and 2022 Series rail-mounted terminal blocks; black	www.wago.com/2009-412
	Nr. articol: 2009-414 Push-in type wire jumper; insulated; wire length 110 mm; Conductor cross section 1.5 mm ² ; suitable for 2001, 2002, 2003 and 2022 Series rail-mounted terminal blocks; black	www.wago.com/2009-414
	Nr. articol: 2009-414/000-005 Push-in type wire jumper; insulated; wire length 110 mm; Conductor cross section 1.5 mm ² ; suitable for 2001, 2002, 2003 and 2022 Series rail-mounted terminal blocks; red	www.wago.com/2009-414/000-005
	Nr. articol: 2009-414/000-006 Push-in type wire jumper; insulated; wire length 110 mm; Conductor cross section 1.5 mm ² ; suitable for 2001, 2002, 2003 and 2022 Series rail-mounted terminal blocks; blue	www.wago.com/2009-414/000-006
	Nr. articol: 2009-416 Push-in type wire jumper; insulated; wire length 250 mm; Conductor cross section 1.5 mm ² ; suitable for 2001, 2002, 2003 and 2022 Series rail-mounted terminal blocks; black	www.wago.com/2009-416
tools		
	Nr. articol: 210-658 Operating tool; Blade: 3.5 x 0.5 mm; with a partially insulated shaft; angled; short	www.wago.com/210-658
	Nr. articol: 210-720 Operating tool; Blade: 3.5 x 0.5 mm; with a partially insulated shaft	www.wago.com/210-720
End plate		
	Nr. articol: 2002-2295 Separator plate; oversized upper deck; snap-fit type; 2 mm thick; gray	www.wago.com/2002-2295
	Nr. articol: 2002-2296 Separator plate; oversized upper deck; snap-fit type; 2 mm thick; orange	www.wago.com/2002-2296
Jumper		
	Nr. articol: 210-103 Wire commoning chain; insulated; 50 connections; black	www.wago.com/210-103
	Nr. articol: 210-123 Wire commoning chain; insulated; 50 connections	www.wago.com/210-123
Carrier rail		
	Nr. articol: 210-112 Steel carrier rail; 35 x 7.5 mm; 1 mm thick; 2 m long; slotted; according to EN 60715; "Hole width 25 mm	www.wago.com/210-112
	Nr. articol: 210-113 Steel carrier rail; 35 x 7.5 mm; 1 mm thick; 2 m long; unslotted; according to EN 60715	www.wago.com/210-113















Supus modificărilor.

	Nr. articol: 210-114 Steel carrier rail; 35 x 15 mm; 1.5 mm thick; 2 m long; unslotted; similar to EN 60715	www.wago.com/210-114
	Nr. articol: 210-115 Steel carrier rail; 35 x 7.5 mm; 1 mm thick; 2 m long; slotted; according to EN 60715; "Hole width 18 mm	www.wago.com/210-115
	Nr. articol: 210-118 Steel carrier rail; 35 x 15 mm; 2.3 mm thick; 2 m long; unslotted; according to EN 60715	www.wago.com/210-118
	Nr. articol: 210-196 Aluminum carrier rail; 35 x 8.2 mm; 1.6 mm thick; 2 m long; unslotted; similar to EN 60715; silver-colored	www.wago.com/210-196
	Nr. articol: 210-197 Steel carrier rail; 35 x 15 mm; 1.5 mm thick; 2 m long; slotted; similar to EN 60715	www.wago.com/210-197
	Nr. articol: 210-198 Copper carrier rail; 35 x 15 mm; 2.3 mm thick; 2 m long; unslotted; according to EN 60715; copper-colored	www.wago.com/210-198
	Nr. articol: 210-504 Steel carrier rail; 35 x 7.5 mm; 1 mm thick; 2 m long; slotted; galvanized; according to EN 60715	www.wago.com/210-504
	Nr. articol: 210-505 Steel carrier rail; 35 x 7.5 mm; 1 mm thick; 2 m long; unslotted; galvanized; according to EN 60715	www.wago.com/210-505
	Nr. articol: 210-506 Steel carrier rail; 35 x 15 mm; 1.5 mm thick; 2 m long; unslotted; galvanized; similar to EN 60715	www.wago.com/210-506
	Nr. articol: 210-508 Steel carrier rail; 35 x 15 mm; 1.5 mm thick; 2 m long; slotted; galvanized; similar to EN 60715	www.wago.com/210-508
Marking accessories		
	Nr. articol: 2002-121 Adaptor	www.wago.com/2002-121
	Nr. articol: 2009-110 Marking strips; on reel; not stretchable; plain; snap-on type; white	www.wago.com/2009-110
	Nr. articol: 2009-115 WMB-Inline; for Smart Printer; 1500 pieces on roll; stretchable 5 - 5.2 mm; plain; snap-on type; white	www.wago.com/2009-115
	Nr. articol: 2009-115/000-002 WMB-Inline; for Smart Printer; 1500 pieces on roll; stretchable 5 - 5.2 mm; plain; snap-on type; yellow	www.wago.com/2009-115/000-002
	Nr. articol: 2009-115/000-005 WMB-Inline; for Smart Printer; 1500 pieces on roll; stretchable 5 - 5.2 mm; plain; snap-on type; red	www.wago.com/2009-115/000-005
	Nr. articol: 2009-115/000-006 WMB-Inline; for Smart Printer; 1500 pieces on roll; stretchable 5 - 5.2 mm; plain; snap-on type; blue	www.wago.com/2009-115/000-006















Supus modificărilor.

WAGO Kontakttechnik GmbH & Co. KG
/Representative Office Romania
Sos. Pipera-Tunari nr. 1/1
building 1, 2nd floor | 077190 Voluntari, Ilfov
Tel.: +40-(0)31 421 85 68 | Email: info-RO@wago.com

Aveți întrebări despre produsele noastre?
Vă stăm la dispoziție pentru preluarea apelului la +40 (0) 31 421 85 68.

	Nr. articol: 2009-115/000-007 WMB-Inline; for Smart Printer; 1500 pieces on roll; stretchable 5 - 5.2 mm; plain; snap-on type; gray	www.wago.com/2009-115/000-007
	Nr. articol: 2009-115/000-012 WMB-Inline; for Smart Printer; 1500 pieces on roll; stretchable 5 - 5.2 mm; plain; snap-on type; orange	www.wago.com/2009-115/000-012
	Nr. articol: 2009-115/000-017 WMB-Inline; for Smart Printer; 1500 pieces on roll; stretchable 5 - 5.2 mm; plain; snap-on type; light green	www.wago.com/2009-115/000-017
	Nr. articol: 2009-115/000-023 WMB-Inline; for Smart Printer; 1500 pieces on roll; stretchable 5 - 5.2 mm; plain; snap-on type; green	www.wago.com/2009-115/000-023
	Nr. articol: 2009-115/000-024 WMB-Inline; for Smart Printer; 1500 pieces on roll; stretchable 5 - 5.2 mm; plain; snap-on type; violet	www.wago.com/2009-115/000-024
	Nr. articol: 2009-145 Mini-WSB Inline; for Smart Printer; 1700 pieces on roll; stretchable 5 - 5.2 mm; plain; snap-on type; white	www.wago.com/2009-145
	Nr. articol: 2009-145/000-002 Mini-WSB Inline; for Smart Printer; 1700 pieces on roll; stretchable 5 - 5.2 mm; plain; snap-on type; yellow	www.wago.com/2009-145/000-002
	Nr. articol: 2009-145/000-005 Mini-WSB Inline; for Smart Printer; 1700 pieces on roll; stretchable 5 - 5.2 mm; plain; snap-on type; red	www.wago.com/2009-145/000-005
	Nr. articol: 2009-145/000-006 Mini-WSB Inline; for Smart Printer; 1700 pieces on roll; stretchable 5 - 5.2 mm; plain; snap-on type; blue	www.wago.com/2009-145/000-006
	Nr. articol: 2009-145/000-007 Mini-WSB Inline; for Smart Printer; 1700 pieces on roll; stretchable 5 - 5.2 mm; plain; snap-on type; gray	www.wago.com/2009-145/000-007
	Nr. articol: 2009-145/000-012 Mini-WSB Inline; for Smart Printer; 1700 pieces on roll; stretchable 5 - 5.2 mm; plain; snap-on type; orange	www.wago.com/2009-145/000-012
	Nr. articol: 2009-145/000-023 Mini-WSB Inline; for Smart Printer; 1700 pieces on roll; stretchable 5 - 5.2 mm; plain; snap-on type; green	www.wago.com/2009-145/000-023
	Nr. articol: 2009-145/000-024 Mini-WSB Inline; for Smart Printer; 1700 pieces on roll; stretchable 5 - 5.2 mm; plain; snap-on type; violet	www.wago.com/2009-145/000-024
	Nr. articol: 2009-191 Group marker carrier	www.wago.com/2009-191

Supus modificărilor.

	Nr. articol: 2009-192 Group marker carrier	www.wago.com/2009-192
	Nr. articol: 2009-193 Group marker carrier	www.wago.com/2009-193
	Nr. articol: 2009-198 Adaptor	www.wago.com/2009-198
	Nr. articol: 248-501 Miniature WSB Quick marking system; plain; Marker width 5 mm; 10 strips with 10 markers per card	www.wago.com/248-501
	Nr. articol: 248-501/000-002 Mini-WSB marking card; as card; not stretchable; plain; snap-on type; yellow	www.wago.com/248-501/000-002
	Nr. articol: 248-501/000-005 Mini-WSB marking card; as card; not stretchable; plain; snap-on type; red	www.wago.com/248-501/000-005
	Nr. articol: 248-501/000-006 Mini-WSB marking card; as card; not stretchable; plain; snap-on type; blue	www.wago.com/248-501/000-006
	Nr. articol: 248-501/000-007 Mini-WSB marking card; as card; not stretchable; plain; snap-on type; gray	www.wago.com/248-501/000-007
	Nr. articol: 248-501/000-012 Mini-WSB marking card; as card; not stretchable; plain; snap-on type; orange	www.wago.com/248-501/000-012
	Nr. articol: 248-501/000-017 Mini-WSB marking card; as card; not stretchable; plain; snap-on type; light green	www.wago.com/248-501/000-017
	Nr. articol: 248-501/000-023 Mini-WSB marking card; as card; not stretchable; plain; snap-on type; green	www.wago.com/248-501/000-023
	Nr. articol: 248-501/000-024 Mini-WSB marking card; as card; not stretchable; plain; snap-on type; violet	www.wago.com/248-501/000-024
	Nr. articol: 793-501 WMB marking card; as card; not stretchable; plain; snap-on type; white	www.wago.com/793-501
	Nr. articol: 793-501/000-002 WMB marking card; as card; not stretchable; plain; snap-on type; yellow	www.wago.com/793-501/000-002
	Nr. articol: 793-501/000-005 WMB marking card; as card; not stretchable; plain; snap-on type; red	www.wago.com/793-501/000-005

Supus modificărilor.



Nr. articol: 793-501/000-006
WMB marking card; as card; not stretchable; plain; snap-on type; blue

www.wago.com/793-501/000-006



Nr. articol: 793-501/000-007
WMB marking card; as card; not stretchable; plain; snap-on type; gray

www.wago.com/793-501/000-007



Nr. articol: 793-501/000-012
WMB marking card; as card; not stretchable; plain; snap-on type; orange

www.wago.com/793-501/000-012



Nr. articol: 793-501/000-017
WMB marking card; as card; not stretchable; plain; snap-on type; light green

www.wago.com/793-501/000-017



Nr. articol: 793-501/000-023
WMB marking card; as card; not stretchable; plain; snap-on type; green

www.wago.com/793-501/000-023



Nr. articol: 793-501/000-024
WMB marking card; as card; not stretchable; plain; snap-on type; violet

www.wago.com/793-501/000-024



Nr. articol: 793-5501
WMB marking card; as card; for terminal block width 5 - 17.5 mm; stretchable 5 - 5.2 mm; plain; snap-on type; white

www.wago.com/793-5501



Nr. articol: 793-5501/000-002
WMB marking card; as card; for terminal block width 5 - 17.5 mm; stretchable 5 - 5.2 mm; plain; snap-on type; yellow

www.wago.com/793-5501/000-002



Nr. articol: 793-5501/000-005
WMB marking card; as card; for terminal block width 5 - 17.5 mm; stretchable 5 - 5.2 mm; plain; snap-on type; red

www.wago.com/793-5501/000-005



Nr. articol: 793-5501/000-006
WMB marking card; as card; for terminal block width 5 - 17.5 mm; stretchable 5 - 5.2 mm; plain; snap-on type; blue

www.wago.com/793-5501/000-006



Nr. articol: 793-5501/000-007
WMB marking card; as card; for terminal block width 5 - 17.5 mm; stretchable 5 - 5.2 mm; plain; snap-on type; gray

www.wago.com/793-5501/000-007



Nr. articol: 793-5501/000-012
WMB marking card; as card; for terminal block width 5 - 17.5 mm; stretchable 5 - 5.2 mm; plain; snap-on type; orange

www.wago.com/793-5501/000-012



Nr. articol: 793-5501/000-014
WMB marking card; as card; for terminal block width 5 - 17.5 mm; stretchable 5 - 5.2 mm; plain; snap-on type; brown

www.wago.com/793-5501/000-014

Nr. articol: 793-5501/000-017

Supus modificărilor.

WAGO Kontakttechnik GmbH & Co. KG
/Representative Office Romania
Sos. Pipera-Tunari nr. 1/1
building 1, 2nd floor | 077190 Voluntari, Ilfov
Tel.: +40-(0)31 421 85 68 | Email: info-RO@wago.com

Aveți întrebări despre produsele noastre?
Vă stăm la dispoziție pentru preluarea apelului la +40 (0) 31 421 85 68.



WMB marking card; as card; for terminal block width 5 - 17.5 mm; stretchable 5 - 5.2 mm; plain; snap-on type; green

www.wago.com/793-5501/000-017



Nr. articol: 793-5501/000-023

WMB marking card; as card; for terminal block width 5 - 17.5 mm; stretchable 5 - 5.2 mm; plain; snap-on type; light green

www.wago.com/793-5501/000-023



Nr. articol: 793-5501/000-024

WMB marking card; as card; for terminal block width 5 - 17.5 mm; stretchable 5 - 5.2 mm; plain; snap-on type; violet

www.wago.com/793-5501/000-024

ferrule



Nr. articol: 216-241

Ferrule; Sleeve for 0.5 mm² / 20 AWG; insulated; electro-tin plated; electrolytic copper; gastight crimped; acc. to DIN 46228, Part 4/09.90; white

www.wago.com/216-241



Nr. articol: 216-242

Ferrule; Sleeve for 0.75 mm² / 18 AWG; insulated; electro-tin plated; electrolytic copper; gastight crimped; acc. to DIN 46228, Part 4/09.90; gray

www.wago.com/216-242



Nr. articol: 216-243

Ferrule; Sleeve for 1 mm² / AWG 18; insulated; electro-tin plated; electrolytic copper; gastight crimped; acc. to DIN 46228, Part 4/09.90; red

www.wago.com/216-243



Nr. articol: 216-244

Ferrule; Sleeve for 1.5 mm² / AWG 16; insulated; electro-tin plated; electrolytic copper; gastight crimped; acc. to DIN 46228, Part 4/09.90; black

www.wago.com/216-244



Nr. articol: 216-246

Ferrule; Sleeve for 2.5 mm² / AWG 14; insulated; electro-tin plated; electrolytic copper; gastight crimped; acc. to DIN 46228, Part 4/09.90; blue

www.wago.com/216-246



Nr. articol: 216-262

Ferrule; Sleeve for 0.75 mm² / 18 AWG; insulated; electro-tin plated; electrolytic copper; gastight crimped; acc. to DIN 46228, Part 4/09.90; gray

www.wago.com/216-262



Nr. articol: 216-263

Ferrule; Sleeve for 1 mm² / AWG 18; insulated; electro-tin plated; electrolytic copper; gastight crimped; acc. to DIN 46228, Part 4/09.90; red

www.wago.com/216-263



Nr. articol: 216-264

Ferrule; Sleeve for 1.5 mm² / AWG 16; insulated; electro-tin plated; electrolytic copper; gastight crimped; acc. to DIN 46228, Part 4/09.90; black

www.wago.com/216-264



Nr. articol: 216-266

Ferrule; Sleeve for 2.5 mm² / AWG 14; insulated; electro-tin plated; electrolytic copper; gastight crimped; acc. to DIN 46228, Part 4/09.90; blue

www.wago.com/216-266

Protective Warning Marker



Nr. articol: 2002-115

Protective warning marker; with high-voltage symbol, black; for 5 terminal blocks; yellow

www.wago.com/2002-115

check



Nr. articol: 2002-611

TOPJOB®S L-type test plug module; modular; 1-pole; 2,50 mm²; gray

www.wago.com/2002-611

Supus modificărilor.



Nr. articol: 2002-649

TOPJOB®S L-type spacer module; modular; e.g., for bridging commoned terminal blocks; gray

www.wago.com/2002-649

Descărcări Documentation

Additional Information

Technical explanations

Apr 3, 2019

pdf
2,1 MB

Descărcare

CAD/CAE-Data

CAE data

EPLAN Data Portal 2002-2201/097-000

URL

Descărcare

WSCAD Universe 2002-2201/097-000

URL

Descărcare

Installation Notes

Conductor termination

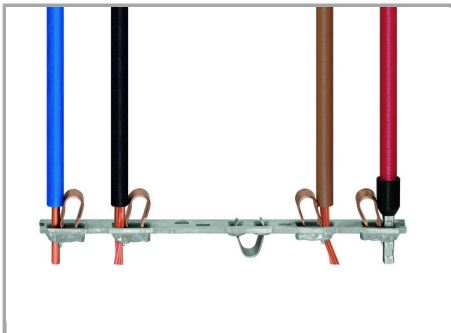

All conductor types at a glance

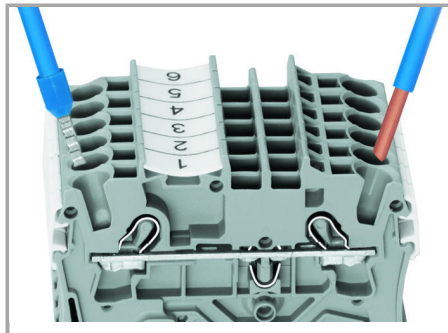

Terminating solid and ferruled conductors via push-in connection.

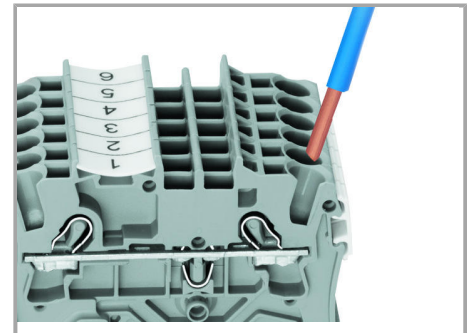

Inserting conductors via push-in termination.

Solid conductors with cross-sections from either one size above, or up to two sizes below, the rated cross-section can be simply pushed in – no tools needed.

Supus modificărilor.

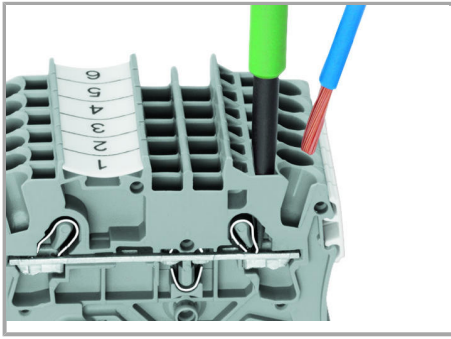

Inserting a conductor via operating tool.

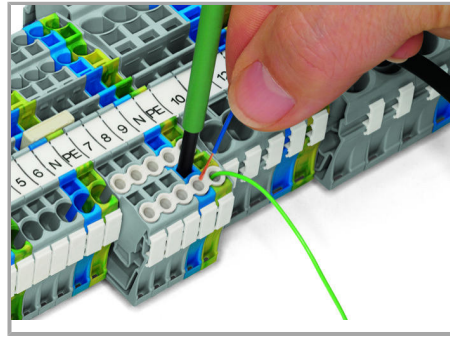

Conductor termination – Insulation stop.

Connecting fine-stranded conductors without ferrules, or small cross-sectional conductors that cannot be pushed in, is performed similarly to the original CAGE CLAMP® – just use an operating tool.

The smart feature:

To open the clamp, the operating tool is inserted vertically. The conductor entry is less than 15 degrees for easier wiring.

Familie de produse

TOPJOB® S

TOPJOB® S: In various industrial applications and modern building installations, WAGO's wide and versatile range of rail-mount terminal blocks provides more than just reliable electrical connections.

[Afișare globală produse din familie.](#)

Supus modificărilor.