

## Fișă tehnică | Număr articol: 2007-8801/046-000

2-conductor through terminal block; 6 mm<sup>2</sup>; with touch-proof test socket; for 4 mm Ø test plugs; side and center marking; for DIN-rail 35 x 15 and 35 x 7.5; Push-in CAGE CLAMP®; 6,00 mm<sup>2</sup>; gray

[www.wago.com/2007-8801/046-000](http://www.wago.com/2007-8801/046-000)

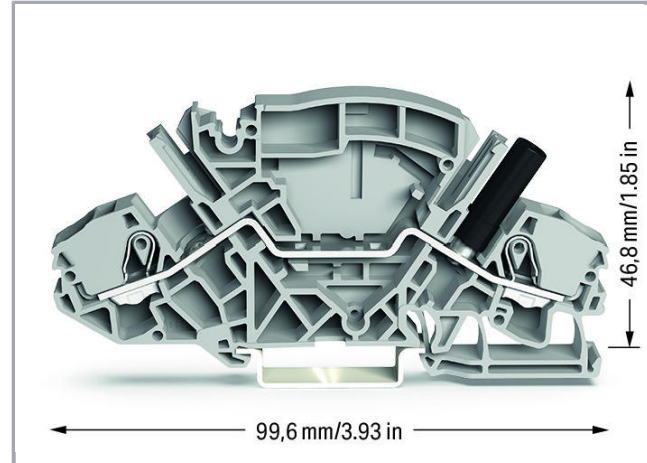
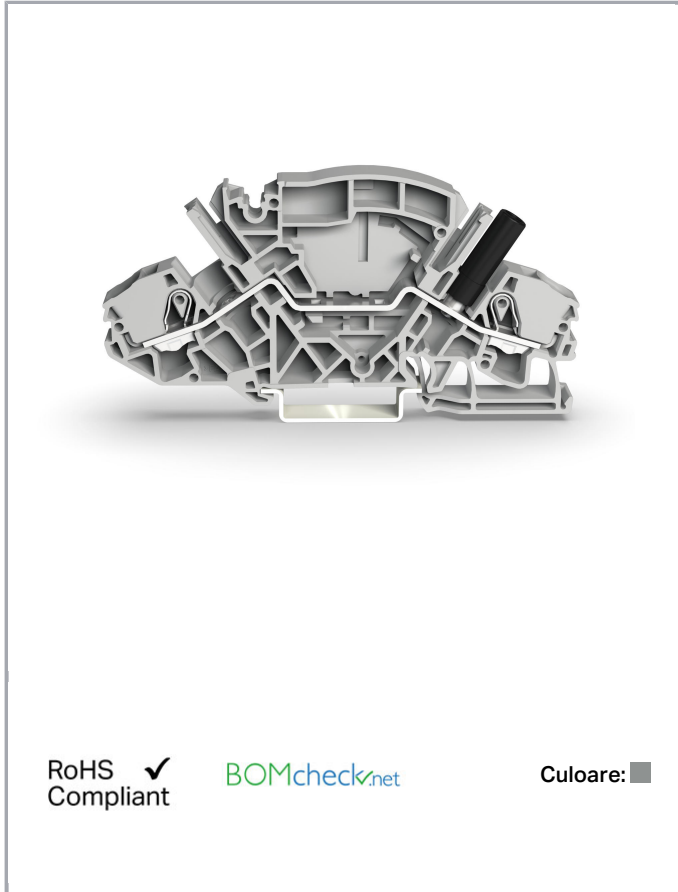

RoHS  
Compliant ✓

BOMcheck.net

Culoare: ■

### Date

#### Electrical data

#### Ratings per IEC/EN 60664-1

Nominal voltage (III/3)	500 V
Rated surge voltage (III/3)	6 kV
Rated current	30 A
Legend (ratings)	(III / 3) ≙ Overvoltage category III / Pollution degree 3

Supus modificărilor.

WAGO Kontakttechnik GmbH & Co. KG  
/Representative Office Romania  
Sos. Pipera-Tunari nr. 1/1  
building 1, 2nd floor | 077190 Voluntari, Ilfov  
Tel.: +40-(0)31 421 85 68 | Email: info-RO@wago.com

Aveți întrebări despre produsele noastre?  
Vă stăm la dispoziție pentru preluarea apelului la +40 (0) 31 421 85 68.

## Approvals per UL 1059

Rated voltage UL (Use Group B)	300 V
Rated current UL (Use Group B)	30 A
Rated voltage UL (Use Group C)	300 V
Rated current UL (Use Group C)	30 A
Rated voltage UL (Use Group D)	300 V
Rated current UL (Use Group D)	10 A
Approvals per	UL 1059

## Connection data

Connection technology	Push-in CAGE CLAMP®
Actuation type	Push-in Open Tool Slot
Connectable conductor materials	Copper
Nominal cross-section	6 mm <sup>2</sup>
Solid conductor	0,5 ... 10 mm <sup>2</sup> / 20 ... 8 AWG
Solid conductor; push-in termination	1 ... 10 mm <sup>2</sup> / 14 ... 8 AWG
Fine-stranded conductor	0,5 ... 10 mm <sup>2</sup> / 20 ... 8 AWG
Fine-stranded conductor; with insulated ferrule	2,5 ... 6 mm <sup>2</sup> / 16 ... 10 AWG
Fine-stranded conductor; with uninsulated ferrule	1,5 ... 6 mm <sup>2</sup> / 16 ... 10 AWG
Fine-stranded conductor; with ferrule; push-in termination	2,5 ... 6 mm <sup>2</sup> / 16 ... 16 AWG
Strip length	13 ... 15 mm / 0.51 ... 0.59 inch
Total number of connection points	2
Number of levels	1
Wiring type	Front-entry wiring
Number of jumper slots	2

## Geometrical Data

Width	8 mm / 0.315 inch
Height from upper-edge of DIN-rail	46,8 mm / 1.843 inch
Depth	99,6 mm / 3.921 inch

## Mechanical data

Design	angled
Mounting type	DIN-35 rail

Supus modificărilor.

WAGO Kontakttechnik GmbH & Co. KG  
/Representative Office Romania  
Sos. Pipera-Tunari nr. 1/1  
building 1, 2nd floor | 077190 Voluntari, Ilfov  
Tel.: +40-(0)31 421 85 68 | Email: info-RO@wago.com

Aveți întrebări despre produsele noastre?  
Vă stăm la dispoziție pentru preluarea apelului la +40 (0) 31 421 85 68.

Marking level

Center/side marking

## Material Data



Color	gray
Insulation material	Polyamide 66 (PA 66)
Weight	22 g

## Commercial data

Packaging type	BOX
Country of origin	CN
GTIN	4055143394840
Customs tariff number	85369010000

## Aprobări / certificate

### Country specific Approvals

Emblemă	Aprobare	Text de aprobare suplimentar	Nume certificat
	CCA DEKRA Certification B.V.	EN 60947	2198208.01
	CSA DEKRA Certification B.V.	C22.2 No. 158	70009679

### Ship Approvals

Emblemă	Aprobare	Text de aprobare suplimentar	Nume certificat
	DNV GL Det Norske Veritas, Germanischer Lloyd	-	TAE00001V2

### UL-Approvals

Emblemă	Aprobare	Text de aprobare suplimentar	Nume certificat
	cURus UL International Germany GmbH	UL 1059	E45172

Supus modificărilor.











WAGO Kontakttechnik GmbH & Co. KG  
/Representative Office Romania  
Sos. Pipera-Tunari nr. 1/1  
building 1, 2nd floor | 077190 Voluntari, Ilfov  
Tel.: +40-(0)31 421 85 68 | Email: info-RO@wago.com

Aveți întrebări despre produsele noastre?  
Vă stăm la dispoziție pentru preluarea apelului la +40 (0) 31 421 85 68.







## Counterpart

## Produse compatibile







## Jumper

	<b>Nr. articol: 282-432</b> Jumper; insulated; 2-way; Nominal current 30 A; orange	<a href="http://www.wago.com/282-432">www.wago.com/282-432</a>
	<b>Nr. articol: 282-432/100-000</b> Jumper with safety lid; insulated; 2-way; Nominal current 30 A; orange	<a href="http://www.wago.com/282-432/100-000">www.wago.com/282-432/100-000</a>
	<b>Nr. articol: 282-433</b> Jumper; insulated; 3-way; Nominal current 30 A; orange	<a href="http://www.wago.com/282-433">www.wago.com/282-433</a>
	<b>Nr. articol: 282-433/100-000</b> Jumper with safety lid; insulated; 3-way; Nominal current 30 A; orange	<a href="http://www.wago.com/282-433/100-000">www.wago.com/282-433/100-000</a>
	<b>Nr. articol: 282-434</b> Jumper; insulated; 4-way; Nominal current 30 A; orange	<a href="http://www.wago.com/282-434">www.wago.com/282-434</a>
	<b>Nr. articol: 282-434/100-000</b> Jumper with safety lid; insulated; 4-way; Nominal current 30 A; orange	<a href="http://www.wago.com/282-434/100-000">www.wago.com/282-434/100-000</a>
	<b>Nr. articol: 282-435</b> Jumper; insulated; 5-way; Nominal current 30 A; orange	<a href="http://www.wago.com/282-435">www.wago.com/282-435</a>
	<b>Nr. articol: 282-435/011-000</b> Jumper; insulated; 3-way (1-3-5); Nominal current 30 A; special version; orange	<a href="http://www.wago.com/282-435/011-000">www.wago.com/282-435/011-000</a>
	<b>Nr. articol: 282-435/300-000</b> Jumper; insulated; Nominal current 30 A; orange	<a href="http://www.wago.com/282-435/300-000">www.wago.com/282-435/300-000</a>
	<b>Nr. articol: 282-435/301-000</b> Jumper; orange	<a href="http://www.wago.com/282-435/301-000">www.wago.com/282-435/301-000</a>
	<b>Nr. articol: 282-436</b> Jumper; insulated; 6-way; Nominal current 30 A; orange	<a href="http://www.wago.com/282-436">www.wago.com/282-436</a>

Supus modificărilor.

	<b>Nr. articol: 282-436/301-000</b> Jumper; insulated; 1-2-4-6; Nominal current 30 A; special version; orange	<a href="http://www.wago.com/282-436/301-000">www.wago.com/282-436/301-000</a>
	<b>Nr. articol: 282-436/304-000</b> Jumper; orange	<a href="http://www.wago.com/282-436/304-000">www.wago.com/282-436/304-000</a>
	<b>Nr. articol: 282-437</b> Jumper; insulated; 7-way; Nominal current 30 A; orange	<a href="http://www.wago.com/282-437">www.wago.com/282-437</a>
	<b>Nr. articol: 282-437/011-000</b> Jumper; insulated; 1-3-5-7; Nominal current 30 A; special version; orange	<a href="http://www.wago.com/282-437/011-000">www.wago.com/282-437/011-000</a>
	<b>Nr. articol: 282-437/012-000</b> Jumper; insulated; 1-4-7; Nominal current 30 A; special version; orange	<a href="http://www.wago.com/282-437/012-000">www.wago.com/282-437/012-000</a>
	<b>Nr. articol: 282-438</b> Jumper; insulated; 8-way; Nominal current 30 A; orange	<a href="http://www.wago.com/282-438">www.wago.com/282-438</a>
	<b>Nr. articol: 282-438/300-000</b> Jumper; insulated; 1-2-5-8; Nominal current 30 A; special version; orange	<a href="http://www.wago.com/282-438/300-000">www.wago.com/282-438/300-000</a>
	<b>Nr. articol: 282-438/301-000</b> Jumper; insulated; 1-4-7-8; Nominal current 30 A; special version; orange	<a href="http://www.wago.com/282-438/301-000">www.wago.com/282-438/301-000</a>
	<b>Nr. articol: 282-439</b> Jumper; insulated; 9-way; Nominal current 30 A; orange	<a href="http://www.wago.com/282-439">www.wago.com/282-439</a>
	<b>Nr. articol: 282-439/011-000</b> Jumper; insulated; 1-3-5-7-9; Nominal current 30 A; special version; orange	<a href="http://www.wago.com/282-439/011-000">www.wago.com/282-439/011-000</a>
	<b>Nr. articol: 282-440</b> Jumper; insulated; 10-way; Nominal current 30 A; orange	<a href="http://www.wago.com/282-440">www.wago.com/282-440</a>
<b>tools</b>		
	<b>Nr. articol: 210-721</b> Operating tool; Blade: 5.5 x 0.8 mm; with a partially insulated shaft	<a href="http://www.wago.com/210-721">www.wago.com/210-721</a>
<b>Protective Warning Marker</b>		
	<b>Nr. articol: 2006-115</b> Protective warning marker; with high-voltage symbol, black; for 5 terminal blocks; yellow	<a href="http://www.wago.com/2006-115">www.wago.com/2006-115</a>
<b>Carrier rail</b>		
	<b>Nr. articol: 210-112</b> Steel carrier rail; 35 x 7.5 mm; 1 mm thick; 2 m long; slotted; according to EN 60715; "Hole width 25 mm	<a href="http://www.wago.com/210-112">www.wago.com/210-112</a>

Supus modificărilor.

	<b>Nr. articol: 210-113</b> Steel carrier rail; 35 x 7.5 mm; 1 mm thick; 2 m long; unslotted; according to EN 60715	<a href="http://www.wago.com/210-113">www.wago.com/210-113</a>
	<b>Nr. articol: 210-114</b> Steel carrier rail; 35 x 15 mm; 1.5 mm thick; 2 m long; unslotted; similar to EN 60715	<a href="http://www.wago.com/210-114">www.wago.com/210-114</a>
	<b>Nr. articol: 210-115</b> Steel carrier rail; 35 x 7.5 mm; 1 mm thick; 2 m long; slotted; according to EN 60715; "Hole width 18 mm	<a href="http://www.wago.com/210-115">www.wago.com/210-115</a>
	<b>Nr. articol: 210-118</b> Steel carrier rail; 35 x 15 mm; 2.3 mm thick; 2 m long; unslotted; according to EN 60715	<a href="http://www.wago.com/210-118">www.wago.com/210-118</a>
	<b>Nr. articol: 210-196</b> Aluminum carrier rail; 35 x 8.2 mm; 1.6 mm thick; 2 m long; unslotted; similar to EN 60715; silver-colored	<a href="http://www.wago.com/210-196">www.wago.com/210-196</a>
	<b>Nr. articol: 210-197</b> Steel carrier rail; 35 x 15 mm; 1.5 mm thick; 2 m long; slotted; similar to EN 60715	<a href="http://www.wago.com/210-197">www.wago.com/210-197</a>
	<b>Nr. articol: 210-198</b> Copper carrier rail; 35 x 15 mm; 2.3 mm thick; 2 m long; unslotted; according to EN 60715; copper-colored	<a href="http://www.wago.com/210-198">www.wago.com/210-198</a>















**Marking accessories**

	<b>Nr. articol: 2009-110</b> Marking strips; on reel; not stretchable; plain; snap-on type; white	<a href="http://www.wago.com/2009-110">www.wago.com/2009-110</a>
	<b>Nr. articol: 2009-115</b> WMB-Inline; for Smart Printer; 1500 pieces on roll; stretchable 5 - 5.2 mm; plain; snap-on type; white	<a href="http://www.wago.com/2009-115">www.wago.com/2009-115</a>
	<b>Nr. articol: 2009-115/000-002</b> WMB-Inline; for Smart Printer; 1500 pieces on roll; stretchable 5 - 5.2 mm; plain; snap-on type; yellow	<a href="http://www.wago.com/2009-115/000-002">www.wago.com/2009-115/000-002</a>
	<b>Nr. articol: 2009-115/000-006</b> WMB-Inline; for Smart Printer; 1500 pieces on roll; stretchable 5 - 5.2 mm; plain; snap-on type; blue	<a href="http://www.wago.com/2009-115/000-006">www.wago.com/2009-115/000-006</a>
	<b>Nr. articol: 2009-115/000-007</b> WMB-Inline; for Smart Printer; 1500 pieces on roll; stretchable 5 - 5.2 mm; plain; snap-on type; gray	<a href="http://www.wago.com/2009-115/000-007">www.wago.com/2009-115/000-007</a>
	<b>Nr. articol: 2009-115/000-012</b> WMB-Inline; for Smart Printer; 1500 pieces on roll; stretchable 5 - 5.2 mm; plain; snap-on type; orange	<a href="http://www.wago.com/2009-115/000-012">www.wago.com/2009-115/000-012</a>
	<b>Nr. articol: 2009-115/000-017</b> WMB-Inline; for Smart Printer; 1500 pieces on roll; stretchable 5 - 5.2 mm; plain; snap-on type; light green	<a href="http://www.wago.com/2009-115/000-017">www.wago.com/2009-115/000-017</a>
	<b>Nr. articol: 2009-115/000-023</b> WMB-Inline; for Smart Printer; 1500 pieces on roll; stretchable 5 - 5.2 mm; plain; snap-on type; green	<a href="http://www.wago.com/2009-115/000-023">www.wago.com/2009-115/000-023</a>



Supus modificărilor.

WAGO Kontakttechnik GmbH & Co. KG  
/Representative Office Romania  
Sos. Pipera-Tunari nr. 1/1  
building 1, 2nd floor | 077190 Voluntari, Ilfov  
Tel.: +40-(0)31 421 85 68 | Email: info-RO@wago.com

Aveți întrebări despre produsele noastre?  
Vă stăm la dispoziție pentru preluarea apelului la +40 (0) 31 421 85 68.

	<b>Nr. articol: 2009-115/000-024</b> WMB-Inline; for Smart Printer; 1500 pieces on roll; stretchable 5 - 5.2 mm; plain; snap-on type; violet	<a href="http://www.wago.com/2009-115/000-024">www.wago.com/2009-115/000-024</a>
	<b>Nr. articol: 2009-198</b> Adaptor	<a href="http://www.wago.com/2009-198">www.wago.com/2009-198</a>
	<b>Nr. articol: 793-501</b> WMB marking card; as card; not stretchable; plain; snap-on type; white	<a href="http://www.wago.com/793-501">www.wago.com/793-501</a>
	<b>Nr. articol: 793-501/000-002</b> WMB marking card; as card; not stretchable; plain; snap-on type; yellow	<a href="http://www.wago.com/793-501/000-002">www.wago.com/793-501/000-002</a>
	<b>Nr. articol: 793-501/000-005</b> WMB marking card; as card; not stretchable; plain; snap-on type; red	<a href="http://www.wago.com/793-501/000-005">www.wago.com/793-501/000-005</a>
	<b>Nr. articol: 793-501/000-006</b> WMB marking card; as card; not stretchable; plain; snap-on type; blue	<a href="http://www.wago.com/793-501/000-006">www.wago.com/793-501/000-006</a>
	<b>Nr. articol: 793-501/000-007</b> WMB marking card; as card; not stretchable; plain; snap-on type; gray	<a href="http://www.wago.com/793-501/000-007">www.wago.com/793-501/000-007</a>
	<b>Nr. articol: 793-501/000-012</b> WMB marking card; as card; not stretchable; plain; snap-on type; orange	<a href="http://www.wago.com/793-501/000-012">www.wago.com/793-501/000-012</a>
	<b>Nr. articol: 793-501/000-017</b> WMB marking card; as card; not stretchable; plain; snap-on type; light green	<a href="http://www.wago.com/793-501/000-017">www.wago.com/793-501/000-017</a>
	<b>Nr. articol: 793-501/000-023</b> WMB marking card; as card; not stretchable; plain; snap-on type; green	<a href="http://www.wago.com/793-501/000-023">www.wago.com/793-501/000-023</a>
	<b>Nr. articol: 793-501/000-024</b> WMB marking card; as card; not stretchable; plain; snap-on type; violet	<a href="http://www.wago.com/793-501/000-024">www.wago.com/793-501/000-024</a>
<b>ferrule</b>		
	<b>Nr. articol: 216-208</b> Ferrule; Sleeve for 6 mm <sup>2</sup> / AWG 10; insulated; electro-tin plated; electrolytic copper; gastight crimped; acc. to DIN 46228, Part 4/09.90; yellow	<a href="http://www.wago.com/216-208">www.wago.com/216-208</a>
	<b>Nr. articol: 216-262</b> Ferrule; Sleeve for 0.75 mm <sup>2</sup> / 18 AWG; insulated; electro-tin plated; electrolytic copper; gastight crimped; acc. to DIN 46228, Part 4/09.90; gray	<a href="http://www.wago.com/216-262">www.wago.com/216-262</a>
	<b>Nr. articol: 216-263</b> Ferrule; Sleeve for 1 mm <sup>2</sup> / AWG 18; insulated; electro-tin plated; electrolytic copper; gastight crimped; acc. to DIN 46228, Part 4/09.90; red	<a href="http://www.wago.com/216-263">www.wago.com/216-263</a>

Supus modificărilor.

	<p><b>Nr. articol: 216-264</b>                  Ferrule; Sleeve for 1.5 mm<sup>2</sup> / AWG 16; insulated; electro-tin plated; electrolytic copper; gastight crimped; acc. to DIN 46228, Part 4/09.90; black</p>	<a href="http://www.wago.com/216-264">www.wago.com/216-264</a>
	<p><b>Nr. articol: 216-266</b>                  Ferrule; Sleeve for 2.5 mm<sup>2</sup> / AWG 14; insulated; electro-tin plated; electrolytic copper; gastight crimped; acc. to DIN 46228, Part 4/09.90; blue</p>	<a href="http://www.wago.com/216-266">www.wago.com/216-266</a>
	<p><b>Nr. articol: 216-267</b>                  Ferrule; Sleeve for 4 mm<sup>2</sup> / AWG 12; insulated; electro-tin plated; electrolytic copper; gastight crimped; acc. to DIN 46228, Part 4/09.90; gray</p>	<a href="http://www.wago.com/216-267">www.wago.com/216-267</a>

## Descărcări

### Documentation

#### Additional Information

Technical explanations	Apr 3, 2019	pdf 2,1 MB	Descărcare
------------------------	-------------	---------------	------------

## CAD/CAE-Data

### CAD data

2D/3D Models 2007-8801/046-000	URL	Descărcare
--------------------------------	-----	------------

### CAE data

EPLAN Data Portal 2007-8801/046-000	URL	Descărcare
-------------------------------------	-----	------------

WSCAD Universe 2007-8801/046-000	URL	Descărcare
----------------------------------	-----	------------

## Installation Notes

### Conductor termination

Supus modificărilor.



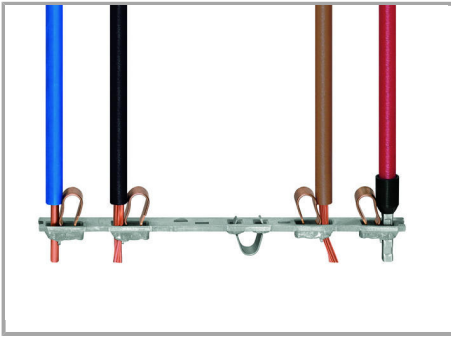

All conductor types at a glance

### Commoning

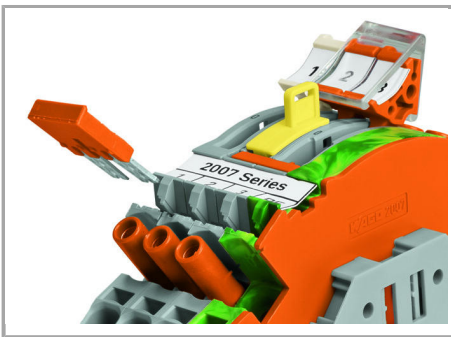

Additional commoning option on the transformer side

### Safety

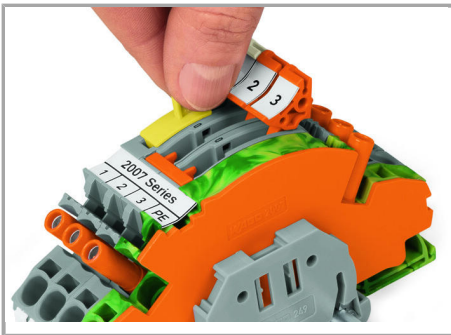

Lock-out prevents accidental operation of disconnect link.

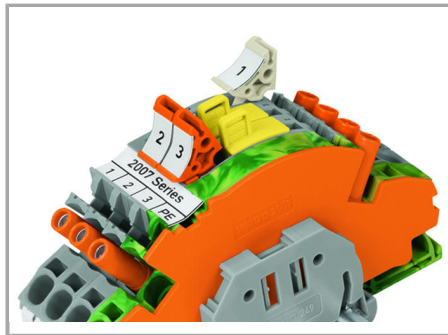

Lock-out snaps into one of two notched positions.

### Locking lever

Supus modificărilor.

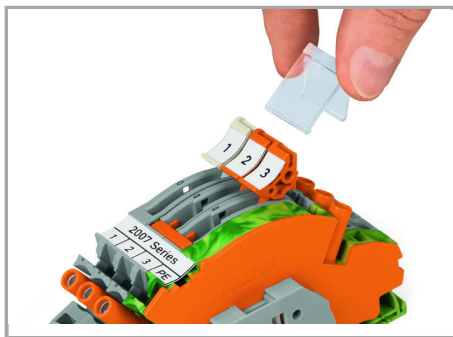

Using locking covers or profiles for adjacent terminal blocks allows disconnect links to be operated simultaneously.

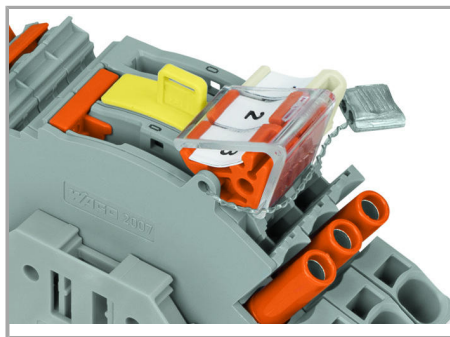

A lock-out seal can be used on the disconnect link in operating position I in combination with an end and separator plate (2007-8893 or 2007-8894).

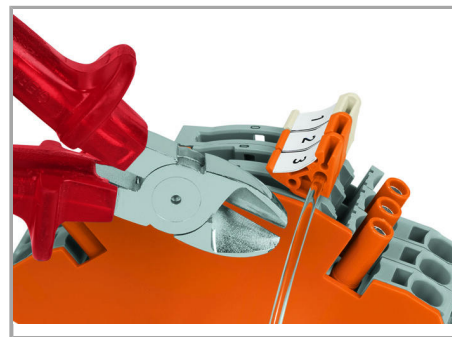

Interlocking link mechanically locks multiple links for multi-pole switching applications.

### Marking

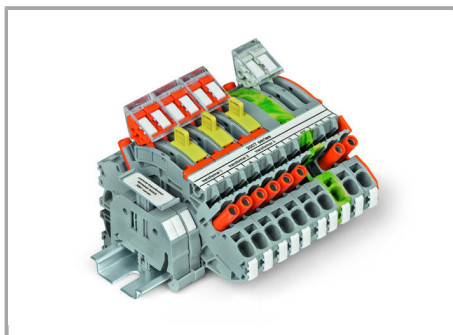

Marking via WMB Multi markers or marking strips.

### Familie de produse

#### TOPJOB® S

TOPJOB® S: In various industrial applications and modern building installations, WAGO's wide and versatile range of rail-mount terminal blocks provides more than just reliable electrical connections.

[Afișare globală produse din familie.](#)

Supus modificărilor.