

Fișă tehnică | Număr articol: 2007-8801/045-000

2-conductor through terminal block; 6 mm²; with touch-proof test socket; for 4 mm Ø test plugs; side and center marking; for DIN-rail 35 x 15 and 35 x 7.5; Push-in CAGE CLAMP®; 6,00 mm²; gray

www.wago.com/2007-8801/045-000

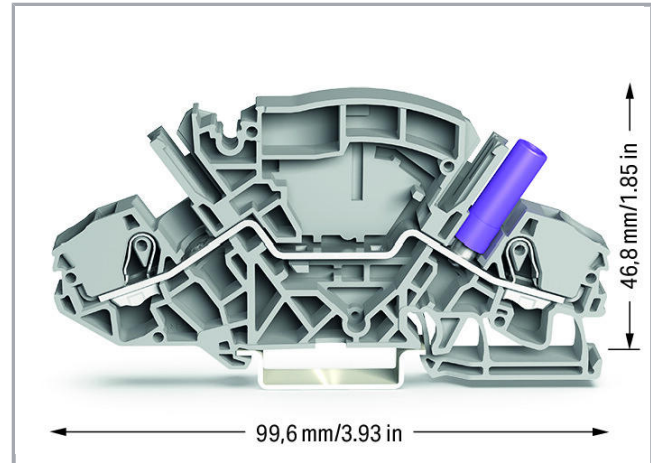
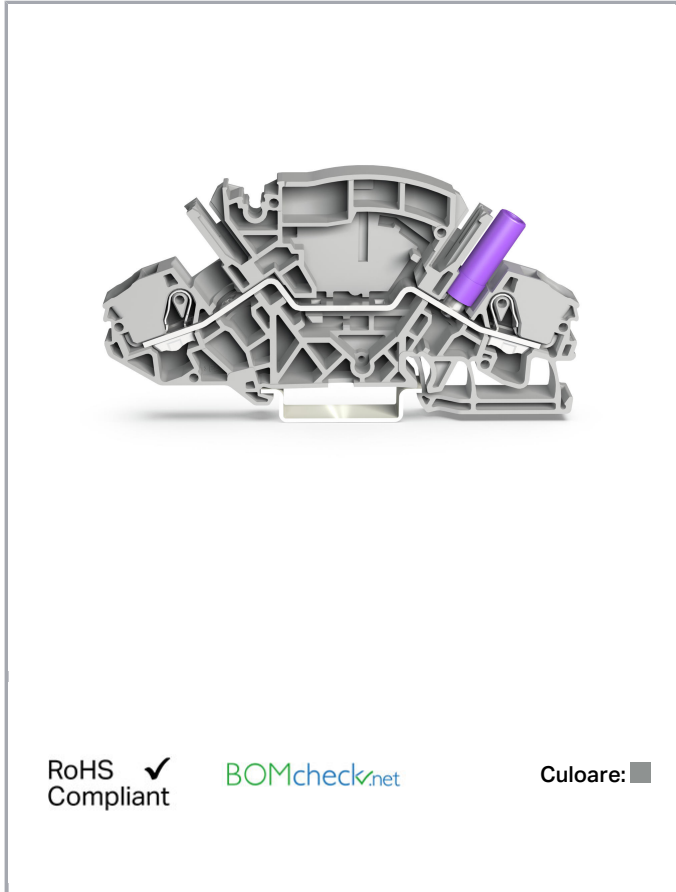

Date

Electrical data

Ratings per IEC/EN 60664-1

| | |
|-----------------------------|---|
| Nominal voltage (III/3) | 500 V |
| Rated surge voltage (III/3) | 6 kV |
| Rated current | 30 A |
| Legend (ratings) | (III / 3) ≙ Overvoltage category III / Pollution degree 3 |

Supus modificărilor.

WAGO Kontakttechnik GmbH & Co. KG
/Representative Office Romania
Sos. Pipera-Tunari nr. 1/1
building 1, 2nd floor | 077190 Voluntari, Ilfov
Tel.: +40-(0)31 421 85 68 | Email: info-RO@wago.com

Aveți întrebări despre produsele noastre?
Vă stăm la dispoziție pentru preluarea apelului la +40 (0) 31 421 85 68.



Approvals per UL 1059

| | |
|--------------------------------|---------|
| Rated voltage UL (Use Group B) | 300 V |
| Rated current UL (Use Group B) | 30 A |
| Rated voltage UL (Use Group C) | 300 V |
| Rated current UL (Use Group C) | 30 A |
| Rated voltage UL (Use Group D) | 300 V |
| Rated current UL (Use Group D) | 10 A |
| Approvals per | UL 1059 |

Connection data

| | |
|--|---|
| Connection technology | Push-in CAGE CLAMP® |
| Actuation type | Push-in Open Tool Slot |
| Connectable conductor materials | Copper |
| Nominal cross-section | 6 mm ² |
| Solid conductor | 0,5 ... 10 mm ² / 20 ... 8 AWG |
| Solid conductor; push-in termination | 1 ... 10 mm ² / 14 ... 8 AWG |
| Fine-stranded conductor | 0,5 ... 10 mm ² / 20 ... 8 AWG |
| Fine-stranded conductor; with insulated ferrule | 2,5 ... 6 mm ² / 16 ... 10 AWG |
| Fine-stranded conductor; with uninsulated ferrule | 1,5 ... 6 mm ² / 16 ... 10 AWG |
| Fine-stranded conductor; with ferrule; push-in termination | 2,5 ... 6 mm ² / 16 ... 15 AWG |
| Strip length | 13 ... 15 mm / 0.51 ... 0.59 inch |
| Total number of connection points | 2 |
| Number of levels | 1 |
| Wiring type | Front-entry wiring |
| Number of jumper slots | 2 |

Geometrical Data

| | |
|------------------------------------|----------------------|
| Width | 8 mm / 0.315 inch |
| Height from upper-edge of DIN-rail | 46,8 mm / 1.843 inch |
| Depth | 99,6 mm / 3.921 inch |

Mechanical data

| | |
|---------------|-------------|
| Design | angled |
| Mounting type | DIN-35 rail |

Supus modificărilor.

WAGO Kontakttechnik GmbH & Co. KG
/Representative Office Romania
Sos. Pipera-Tunari nr. 1/1
building 1, 2nd floor | 077190 Voluntari, Ilfov
Tel.: +40-(0)31 421 85 68 | Email: info-RO@wago.com

Aveți întrebări despre produsele noastre?
Vă stăm la dispoziție pentru preluarea apelului la +40 (0) 31 421 85 68.

| | |
|---------------|---------------------|
| Marking level | Center/side marking |
|---------------|---------------------|

Material Data



| | |
|---------------------|----------------------|
| Color | gray |
| Insulation material | Polyamide 66 (PA 66) |
| Weight | 21,8g |

Commercial data

| | |
|-----------------------|---------------|
| Packaging type | BOX |
| Country of origin | CN |
| GTIN | 4055143314039 |
| Customs tariff number | 85369010000 |

Aprobări / certificate

Country specific Approvals

| Emblemă | Aprobare | Text de aprobare suplimentar | Nume certificat |
|--|--|------------------------------|-----------------|
|  | CCA DEKRA Certification B.V. | EN 60947 | 2198208.01 |
|  | CSA DEKRA Certification B.V. | C22.2 No. 158 | 70009679 |

Ship Approvals

| Emblemă | Aprobare | Text de aprobare suplimentar | Nume certificat |
|--|---|------------------------------|-----------------|
|  | DNV GL Det Norske Veritas, Germanischer Lloyd | - | TAE00001V2 |

UL-Approvals

| Emblemă | Aprobare | Text de aprobare suplimentar | Nume certificat |
|--|---|------------------------------|-----------------|
|  | cURus UL International Germany GmbH | UL 1059 | E45172 |

Supus modificărilor.

WAGO Kontakttechnik GmbH & Co. KG
/Representative Office Romania
Sos. Pipera-Tunari nr. 1/1
building 1, 2nd floor | 077190 Voluntari, Ilfov
Tel.: +40-(0)31 421 85 68 | Email: info-RO@wago.com

Aveți întrebări despre produsele noastre?
Vă stăm la dispoziție pentru preluarea apelului la +40 (0) 31 421 85 68.

Counterpart

Produse compatibile





Carrier rail

| | | |
|--|---|--|
|  | Nr. articol: 210-112 Steel carrier rail; 35 x 7.5 mm; 1 mm thick; 2 m long; slotted; according to EN 60715; "Hole width 25 mm | www.wago.com/210-112 |
|  | Nr. articol: 210-113 Steel carrier rail; 35 x 7.5 mm; 1 mm thick; 2 m long; unslotted; according to EN 60715 | www.wago.com/210-113 |
| | Nr. articol: 210-114 Steel carrier rail; 35 x 15 mm; 1.5 mm thick; 2 m long; unslotted; similar to EN 60715 | www.wago.com/210-114 |
|  | Nr. articol: 210-115 Steel carrier rail; 35 x 7.5 mm; 1 mm thick; 2 m long; slotted; according to EN 60715; "Hole width 18 mm | www.wago.com/210-115 |
|  | Nr. articol: 210-118 Steel carrier rail; 35 x 15 mm; 2.3 mm thick; 2 m long; unslotted; according to EN 60715 | www.wago.com/210-118 |
|  | Nr. articol: 210-196 Aluminum carrier rail; 35 x 8.2 mm; 1.6 mm thick; 2 m long; unslotted; similar to EN 60715; silver-colored | www.wago.com/210-196 |
|  | Nr. articol: 210-197 Steel carrier rail; 35 x 15 mm; 1.5 mm thick; 2 m long; slotted; similar to EN 60715 | www.wago.com/210-197 |
|  | Nr. articol: 210-198 Copper carrier rail; 35 x 15 mm; 2.3 mm thick; 2 m long; unslotted; according to EN 60715; copper-colored | www.wago.com/210-198 |
| ferrule | | |
|  | Nr. articol: 216-208 Ferrule; Sleeve for 6 mm ² / AWG 10; insulated; electro-tin plated; electrolytic copper; gastight crimped; acc. to DIN 46228, Part 4/09.90; yellow | www.wago.com/216-208 |
|  | Nr. articol: 216-262 Ferrule; Sleeve for 0.75 mm ² / 18 AWG; insulated; electro-tin plated; electrolytic copper; gastight crimped; acc. to DIN 46228, Part 4/09.90; gray | www.wago.com/216-262 |
|  | Nr. articol: 216-263 Ferrule; Sleeve for 1 mm ² / AWG 18; insulated; electro-tin plated; electrolytic copper; gastight crimped; acc. to DIN 46228, Part 4/09.90; red | www.wago.com/216-263 |
| | Nr. articol: 216-264 Ferrule; Sleeve for 1.5 mm ² / AWG 16; insulated; electro-tin plated; electrolytic copper; gastight | www.wago.com/216-264 |

Supus modificărilor.

WAGO Kontakttechnik GmbH & Co. KG
/Representative Office Romania
Sos. Pipera-Tunari nr. 1/1
building 1, 2nd floor | 077190 Voluntari, Ilfov
Tel.: +40-(0)31 421 85 68 | Email: info-RO@wago.com















Aveți întrebări despre produsele noastre?
Vă stăm la dispoziție pentru preluarea apelului la +40 (0) 31 421 85 68.

| | | |
|--|--|--|
|  | crimped; acc. to DIN 46228, Part 4/09.90; black | |
|  | Nr. articol: 216-266 Ferrule; Sleeve for 2.5 mm ² / AWG 14; insulated; electro-tin plated; electrolytic copper; gastight crimped; acc. to DIN 46228, Part 4/09.90; blue | www.wago.com/216-266 |
|  | Nr. articol: 216-267 Ferrule; Sleeve for 4 mm ² / AWG 12; insulated; electro-tin plated; electrolytic copper; gastight crimped; acc. to DIN 46228, Part 4/09.90; gray | www.wago.com/216-267 |
| Jumper | | |
|  | Nr. articol: 282-432 Jumper; insulated; 2-way; Nominal current 30 A; orange | www.wago.com/282-432 |
|  | Nr. articol: 282-432/100-000 Jumper with safety lid; insulated; 2-way; Nominal current 30 A; orange | www.wago.com/282-432/100-000 |
|  | Nr. articol: 282-433 Jumper; insulated; 3-way; Nominal current 30 A; orange | www.wago.com/282-433 |
|  | Nr. articol: 282-433/100-000 Jumper with safety lid; insulated; 3-way; Nominal current 30 A; orange | www.wago.com/282-433/100-000 |
|  | Nr. articol: 282-434 Jumper; insulated; 4-way; Nominal current 30 A; orange | www.wago.com/282-434 |
|  | Nr. articol: 282-434/100-000 Jumper with safety lid; insulated; 4-way; Nominal current 30 A; orange | www.wago.com/282-434/100-000 |
|  | Nr. articol: 282-435 Jumper; insulated; 5-way; Nominal current 30 A; orange | www.wago.com/282-435 |
|  | Nr. articol: 282-435/011-000 Jumper; insulated; 3-way (1-3-5); Nominal current 30 A; special version; orange | www.wago.com/282-435/011-000 |
|  | Nr. articol: 282-435/300-000 Jumper; insulated; Nominal current 30 A; orange | www.wago.com/282-435/300-000 |
|  | Nr. articol: 282-435/301-000 Jumper; orange | www.wago.com/282-435/301-000 |
|  | Nr. articol: 282-436 Jumper; insulated; 6-way; Nominal current 30 A; orange | www.wago.com/282-436 |
|  | Nr. articol: 282-436/301-000 Jumper; insulated; 1-2-4-6; Nominal current 30 A; special version; orange | www.wago.com/282-436/301-000 |

Supus modificărilor.

| | | |
|--|---|--|
|  | Nr. articol: 282-436/304-000 Jumper; orange | www.wago.com/282-436/304-000 |
|  | Nr. articol: 282-437 Jumper; insulated; 7-way; Nominal current 30 A; orange | www.wago.com/282-437 |
|  | Nr. articol: 282-437/011-000 Jumper; insulated; 1-3-5-7; Nominal current 30 A; special version; orange | www.wago.com/282-437/011-000 |
|  | Nr. articol: 282-437/012-000 Jumper; insulated; 1-4-7; Nominal current 30 A; special version; orange | www.wago.com/282-437/012-000 |
|  | Nr. articol: 282-438 Jumper; insulated; 8-way; Nominal current 30 A; orange | www.wago.com/282-438 |
|  | Nr. articol: 282-438/300-000 Jumper; insulated; 1-2-5-8; Nominal current 30 A; special version; orange | www.wago.com/282-438/300-000 |
|  | Nr. articol: 282-438/301-000 Jumper; insulated; 1-4-7-8; Nominal current 30 A; special version; orange | www.wago.com/282-438/301-000 |
|  | Nr. articol: 282-439 Jumper; insulated; 9-way; Nominal current 30 A; orange | www.wago.com/282-439 |
|  | Nr. articol: 282-439/011-000 Jumper; insulated; 1-3-5-7-9; Nominal current 30 A; special version; orange | www.wago.com/282-439/011-000 |
|  | Nr. articol: 282-440 Jumper; insulated; 10-way; Nominal current 30 A; orange | www.wago.com/282-440 |
| tools | | |
|  | Nr. articol: 210-721 Operating tool; Blade: 5.5 x 0.8 mm; with a partially insulated shaft | www.wago.com/210-721 |
| Protective Warning Marker | | |
|  | Nr. articol: 2006-115 Protective warning marker; with high-voltage symbol, black; for 5 terminal blocks; yellow | www.wago.com/2006-115 |
| Marking accessories | | |
|  | Nr. articol: 2009-110 Marking strips; on reel; not stretchable; plain; snap-on type; white | www.wago.com/2009-110 |
|  | Nr. articol: 2009-115 WMB-Inline; for Smart Printer; 1500 pieces on roll; stretchable 5 - 5.2 mm; plain; snap-on type; white | www.wago.com/2009-115 |
|  | Nr. articol: 2009-115/000-002 WMB-Inline; for Smart Printer; 1500 pieces on roll; stretchable 5 - 5.2 mm; plain; snap-on type; yellow | www.wago.com/2009-115/000-002 |

Supus modificărilor.

| | | |
|--|--|--|
|  | Nr. articol: 2009-115/000-006 WMB-Inline; for Smart Printer; 1500 pieces on roll; stretchable 5 - 5.2 mm; plain; snap-on type; blue | www.wago.com/2009-115/000-006 |
|  | Nr. articol: 2009-115/000-007 WMB-Inline; for Smart Printer; 1500 pieces on roll; stretchable 5 - 5.2 mm; plain; snap-on type; gray | www.wago.com/2009-115/000-007 |
|  | Nr. articol: 2009-115/000-012 WMB-Inline; for Smart Printer; 1500 pieces on roll; stretchable 5 - 5.2 mm; plain; snap-on type; orange | www.wago.com/2009-115/000-012 |
|  | Nr. articol: 2009-115/000-017 WMB-Inline; for Smart Printer; 1500 pieces on roll; stretchable 5 - 5.2 mm; plain; snap-on type; light green | www.wago.com/2009-115/000-017 |
|  | Nr. articol: 2009-115/000-023 WMB-Inline; for Smart Printer; 1500 pieces on roll; stretchable 5 - 5.2 mm; plain; snap-on type; green | www.wago.com/2009-115/000-023 |
|  | Nr. articol: 2009-115/000-024 WMB-Inline; for Smart Printer; 1500 pieces on roll; stretchable 5 - 5.2 mm; plain; snap-on type; violet | www.wago.com/2009-115/000-024 |
|  | Nr. articol: 2009-198 Adaptor | www.wago.com/2009-198 |
|  | Nr. articol: 793-501 WMB marking card; as card; not stretchable; plain; snap-on type; white | www.wago.com/793-501 |
|  | Nr. articol: 793-501/000-002 WMB marking card; as card; not stretchable; plain; snap-on type; yellow | www.wago.com/793-501/000-002 |
|  | Nr. articol: 793-501/000-005 WMB marking card; as card; not stretchable; plain; snap-on type; red | www.wago.com/793-501/000-005 |
|  | Nr. articol: 793-501/000-006 WMB marking card; as card; not stretchable; plain; snap-on type; blue | www.wago.com/793-501/000-006 |
|  | Nr. articol: 793-501/000-007 WMB marking card; as card; not stretchable; plain; snap-on type; gray | www.wago.com/793-501/000-007 |
|  | Nr. articol: 793-501/000-012 WMB marking card; as card; not stretchable; plain; snap-on type; orange | www.wago.com/793-501/000-012 |
|  | Nr. articol: 793-501/000-017 WMB marking card; as card; not stretchable; plain; snap-on type; light green | www.wago.com/793-501/000-017 |

Supus modificărilor.

WAGO Kontakttechnik GmbH & Co. KG
/Representative Office Romania
Sos. Pipera-Tunari nr. 1/1
building 1, 2nd floor | 077190 Voluntari, Ilfov
Tel.: +40-(0)31 421 85 68 | Email: info-RO@wago.com

Aveți întrebări despre produsele noastre?
Vă stăm la dispoziție pentru preluarea apelului la +40 (0) 31 421 85 68.



Nr. articol: 793-501/000-023
WMB marking card; as card; not stretchable; plain; snap-on type; green

www.wago.com/793-501/000-023



Nr. articol: 793-501/000-024
WMB marking card; as card; not stretchable; plain; snap-on type; violet

www.wago.com/793-501/000-024

Descărcări Documentation

Additional Information

| | | | |
|------------------------|-------------|---------------|------------|
| Technical explanations | Apr 3, 2019 | pdf 2,1 MB | Descărcare |
|------------------------|-------------|---------------|------------|

CAD/CAE-Data

CAD data

| | | |
|--------------------------------|-----|------------|
| 2D/3D Models 2007-8801/045-000 | URL | Descărcare |
|--------------------------------|-----|------------|

CAE data

| | | |
|-------------------------------------|-----|------------|
| EPLAN Data Portal 2007-8801/045-000 | URL | Descărcare |
|-------------------------------------|-----|------------|

| | | |
|----------------------------------|-----|------------|
| WSCAD Universe 2007-8801/045-000 | URL | Descărcare |
|----------------------------------|-----|------------|

Installation Notes

Conductor termination

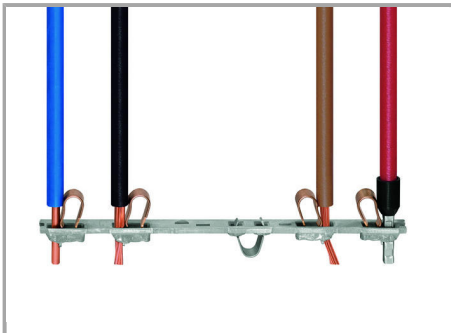

All conductor types at a glance

Supus modificărilor.

WAGO Kontakttechnik GmbH & Co. KG
/Representative Office Romania
Sos. Pipera-Tunari nr. 1/1
building 1, 2nd floor | 077190 Voluntari, Ilfov
Tel.: +40-(0)31 421 85 68 | Email: info-RO@wago.com

Aveți întrebări despre produsele noastre?
Vă stăm la dispoziție pentru preluarea apelului la +40 (0) 31 421 85 68.

Commoning

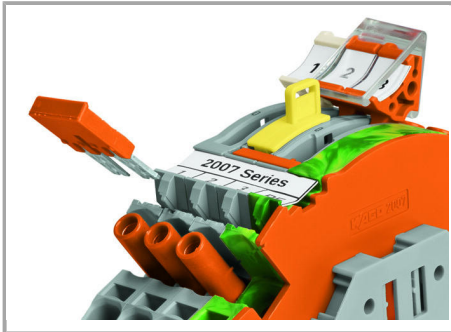

Additional commoning option on the transformer side

Safety

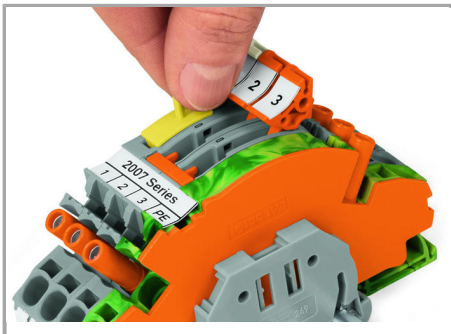

Lock-out prevents accidental operation of disconnect link.

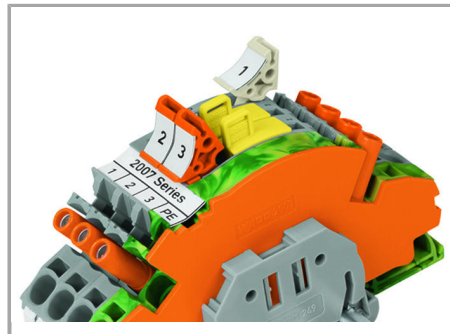

Lock-out snaps into one of two notched positions.

Locking lever

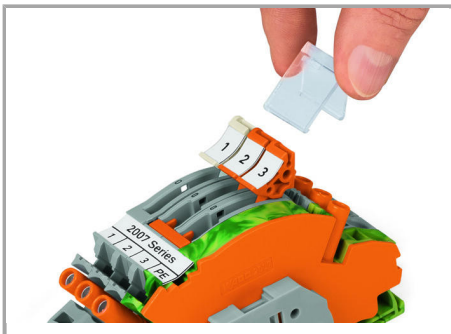

Using locking covers or profiles for adjacent terminal blocks allows disconnect links to be operated simultaneously.

Supus modificărilor.

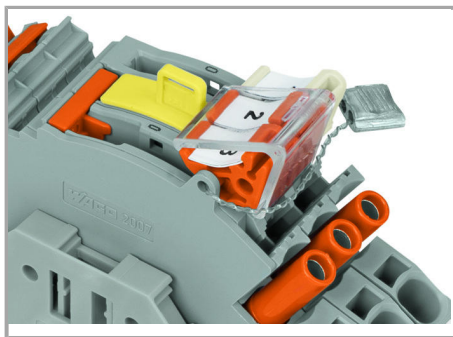

A lock-out seal can be used on the disconnect link in operating position I in combination with an end and separator plate (2007-8893 or 2007-8894).



Interlocking link mechanically locks multiple links for multi-pole switching applications.

Marking

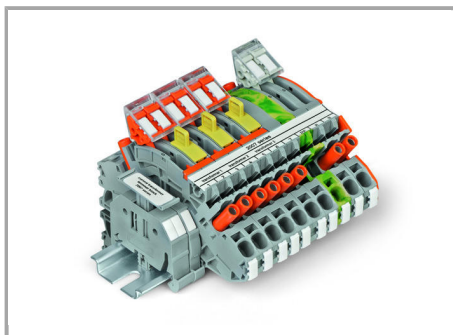

Marking via WMB Multi markers or marking strips.

Familie de produse

TOPJOB® S

TOPJOB® S: In various industrial applications and modern building installations, WAGO's wide and versatile range of rail-mount terminal blocks provides more than just reliable electrical connections.

[Afișare globală produse din familie.](#)

Supus modificărilor.