

## Fișă tehnică | Număr articol: 231-178/001-000

THT male header; 1.2 x 1.2 mm solder pin; straight; Pin spacing 5 mm; 18-pole; gray

[www.wago.com/231-178/001-000](http://www.wago.com/231-178/001-000)

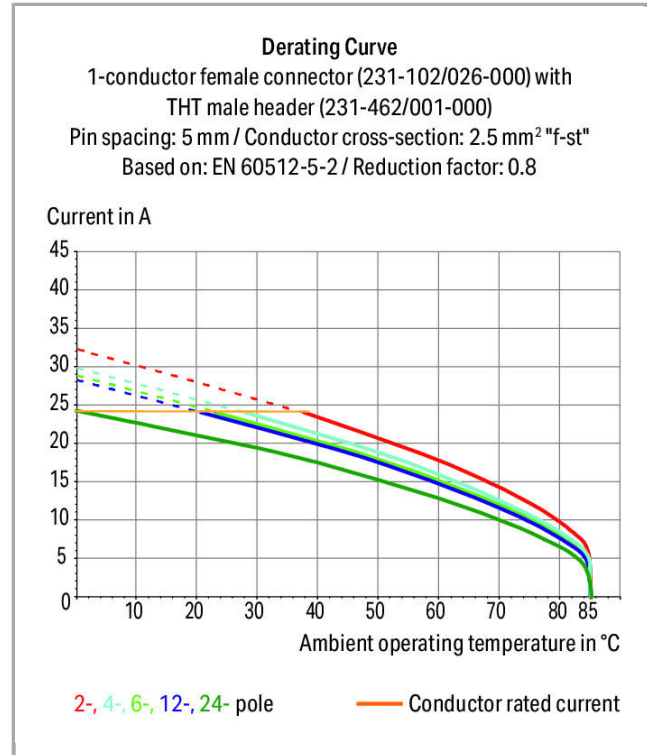
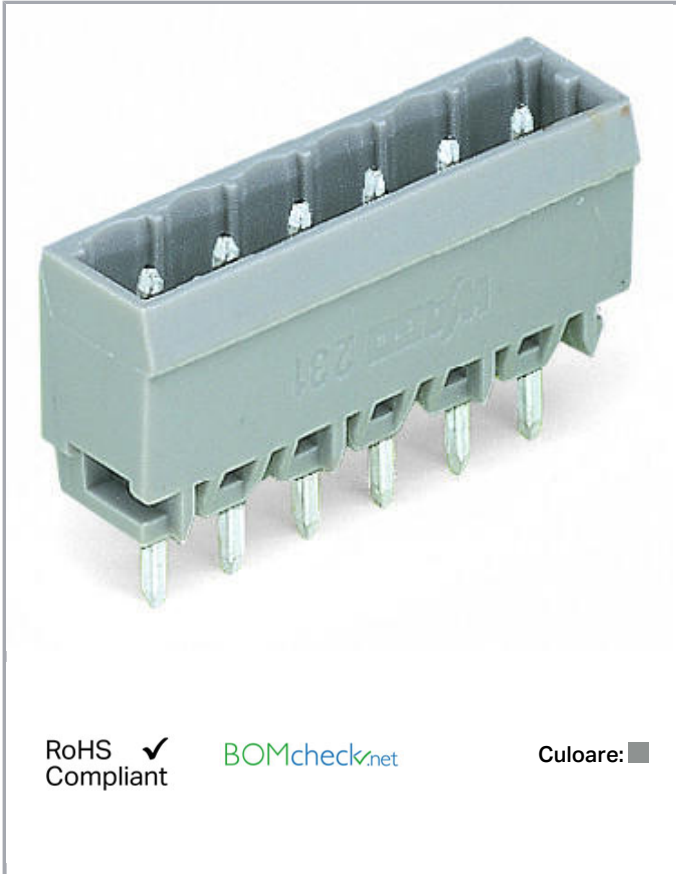

Supus modificărilor.

WAGO Kontakttechnik GmbH & Co. KG  
/Representative Office Romania  
Sos. Pipera-Tunari nr. 1/1  
building 1, 2nd floor | 077190 Voluntari, Ilfov  
Tel.: +40-(0)31 421 85 68 | Email: info-RO@wago.com

Aveți întrebări despre produsele noastre?  
Vă stăm la dispoziție pentru preluarea apelului la +40 (0) 31 421 85 68.

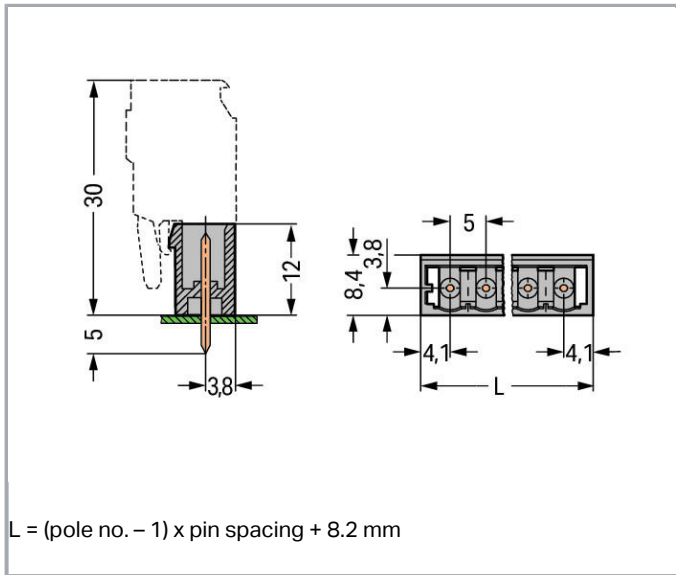

## Descriere articol

- Horizontal or vertical PCB mounting via straight or angled solder pins
- 1.2 x 1.2 mm solder pins allow nominal current up to 16 A, enhancing stability of shorter headers
- With coding fingers

### Safety information 1:

The *MULTI CONNECTION SYSTEM (MCS)* is designed without breaking capacity for compliance with DIN EN 61984. When used as intended, MCS Connectors shall not be connected/disconnected when live or under load. The circuit design should ensure header pins, which can be touched, are not live when unmated.

## Date

### Electrical data

#### Ratings per IEC/EN 60664-1

Ratings per	IEC/EN 60664-1
Nominal voltage (III/3)	250 V
Rated surge voltage (III/3)	4 kV
Rated voltage (III/2)	320 V
Rated surge voltage (III/2)	4 kV
Nominal voltage (II/2)	630 V
Rated surge voltage (II/2)	4 kV
Rated current	16 A

Supus modificărilor.

WAGO Kontakttechnik GmbH & Co. KG  
 /Representative Office Romania  
 Sos. Pipera-Tunari nr. 1/1  
 building 1, 2nd floor | 077190 Voluntari, Ilfov  
 Tel.: +40-(0)31 421 85 68 | Email: info-RO@wago.com

Aveți întrebări despre produsele noastre?  
 Vă stăm la dispoziție pentru preluarea apelului la +40 (0) 31 421 85 68.



Legend (ratings)

(III / 2) ≙ Overvoltage category III / Pollution degree 2

**Approvals per UL 1059**

Rated voltage UL (Use Group B)	300 V
Rated current UL (Use Group B)	15 A
Rated voltage UL (Use Group D)	300 V
Rated current UL (Use Group D)	10 A
Approvals per	UL 1059

**Approvals per UL 1977**

Rated voltage UL 1977	600 V
Rated current UL 1977	15 A

**Approvals per CSA**

Rated voltage CSA (Use Group B)	300 V
Rated current CSA (Use Group B)	15 A
Rated voltage CSA (Use Group D)	300 V
Rated current CSA (Use Group D)	10 A

**Connection data**

Pole No.	18
Total number of potentials	18
Number of connection types	1
Number of levels	1

**Geometrical Data**

Pin spacing	5 mm / 0.197 inch
Width	93.2 mm / 3.669 inch
Height	17 mm / 0.669 inch
Height from the surface	12 mm / 0.472 inch
Depth	8.4 mm / 0.331 inch
Solder pin length	5 mm
Solder pin dimensions	1.2 x 1.2 mm
Drilled hole diameter with tolerance	1.7 <sup>(+0.1)</sup> mm

Supus modificărilor.

WAGO Kontakttechnik GmbH & Co. KG  
 /Representative Office Romania  
 Sos. Pipera-Tunari nr. 1/1  
 building 1, 2nd floor | 077190 Voluntari, Ilfov  
 Tel.: +40-(0)31 421 85 68 | Email: info-RO@wago.com

Aveți întrebări despre produsele noastre?  
 Vă stăm la dispoziție pentru preluarea apelului la +40 (0) 31 421 85 68.



## Plug connection

Contact type (pluggable connector)	Male connector/plug
Connector (connection type)	for PCBs
Mismating protection	No
Mating direction to the PCB	90°

## PCB contact

PCB contact	THT
Solder pin arrangement	over the entire male connector, in line
Number of solder pins per potential	1

## Material Data

Color	gray
Material group	I
Insulation material	Polyamide 66 (PA 66)
Flammability class per UL94	V0
Contact material	Electrolytic copper (E <sub>Cu</sub> )
Contact plating	tin-plated
Fire load	0,101 MJ
Weight	6,8 g

## Environmental Requirements

Limit temperature range	-60 ... +100 °C
-------------------------	-----------------

## Commercial data

Product Group	3 (Multi Conn. System)
Packaging type	BOX
Country of origin	DE
GTIN	4044918928816
Customs tariff number	85366990990

## Aprobări / certificate

### Country specific Approvals

Emblemă	Aprobare	Text de aprobare suplimentar	Nume certificat
---------	----------	------------------------------	-----------------

Supus modificărilor.

WAGO Kontakttechnik GmbH & Co. KG  
 /Representative Office Romania  
 Sos. Pipera-Tunari nr. 1/1  
 building 1, 2nd floor | 077190 Voluntari, Ilfov  
 Tel.: +40-(0)31 421 85 68 | Email: info-RO@wago.com

Aveți întrebări despre produsele noastre?  
 Vă stăm la dispoziție pentru preluarea apelului la +40 (0) 31 421 85 68.





CSA  
DEKRA Certification B.V.



C22.2

1466354

### Ship Approvals

Emblemă	Aprobare	Text de aprobare suplimentar	Nume certificat
	<b>ABS</b> American Bureau of Shipping	-	19- HG1869876- PDA
	<b>DNV GL</b> Det Norske Veritas, Germanischer Lloyd	-	TAE000016Z

### UL-Approvals

Emblemă	Aprobare	Text de aprobare suplimentar	Nume certificat
	<b>UL</b> Underwriters Laboratories Inc.	UL 1059	20190731- E45172
	<b>UR</b> UL International Germany GmbH	UL 1977	E45171

### Counterpart



Nr. articol 231-118/026-000

1-conductor female plug; 2.5 mm<sup>2</sup>; Pin spacing 5 mm; 18-pole; 2,50 mm<sup>2</sup>; gray

[www.wago.com/231-118/026-000](http://www.wago.com/231-118/026-000)

### Produse compatibile

#### Marking accessories



Nr. articol: 210-833

Marking strips; on reel; 6 mm wide; plain; Self-adhesive; white

[www.wago.com/210-833](http://www.wago.com/210-833)

Nr. articol: 210-834

Supus modificărilor.

WAGO Kontakttechnik GmbH & Co. KG  
/Representative Office Romania  
Sos. Pipera-Tunari nr. 1/1  
building 1, 2nd floor | 077190 Voluntari, Ilfov  
Tel.: +40-(0)31 421 85 68 | Email: info-RO@wago.com

Aveți întrebări despre produsele noastre?  
Vă stăm la dispoziție pentru preluarea apelului la +40 (0) 31 421 85 68.



Marking strips; on reel; 5 mm wide; plain; Self-adhesive; white

[www.wago.com/210-834](http://www.wago.com/210-834)

## Coding

**Nr. articol: 231-129**

Coding key; snap-on type; light gray

[www.wago.com/231-129](http://www.wago.com/231-129)**Nr. articol: 231-500**

Spacer; for formation of groups; light gray

[www.wago.com/231-500](http://www.wago.com/231-500)

## Descărcări

### Documentation

#### Additional Information

Technical explanations	Apr 3, 2019	pdf 3,6 MB	Descărcare
------------------------	-------------	---------------	------------

## CAD/CAE-Data

### CAD data

2D/3D Models 231-178/001-000	URL	Descărcare
------------------------------	-----	------------

### CAE data

EPLAN Data Portal 231-178/001-000	URL	Descărcare
-----------------------------------	-----	------------

### PCB Design

Symbol and Footprint 231-178/001-000	URL	Descărcare
--------------------------------------	-----	------------

CAX data for your PCB design, consisting of "schematic symbols and PCB footprints", allow easy integration of the WAGO component into your development environment.

### Supported formats:

- Accel EDA 14 & 15
- Altium 6 to current version
- Cadence Allegro
- DesignSpark
- Eagle Libraries
- KiCad
- Mentor Graphics BoardStation
- Mentor Graphics Design Architect
- Mentor Graphics Design Expedition 99 and 2000

Supus modificărilor.

WAGO Kontakttechnik GmbH & Co. KG  
 /Representative Office Romania  
 Sos. Pipera-Tunari nr. 1/1  
 building 1, 2nd floor | 077190 Voluntari, Ilfov  
 Tel.: +40-(0)31 421 85 68 | Email: info-RO@wago.com

Aveți întrebări despre produsele noastre?  
 Vă stăm la dispoziție pentru preluarea apelului la +40 (0) 31 421 85 68.

- OrCAD 9.X PCB and Capture
- PADS PowerPCB 3, 3.5, 4.X, and 5.X
- PADS PowerPCB and PowerLogic 3.0
- PCAD 2000, 2001, 2002, 2004, and 2006
- Pulsonix 8.5 or newer
- STL
- 3D STEP
- TARGET 3001!
- View Logic ViewDraw
- Quadcept
- Zuken CadStar 3 and 4
- Zuken CR-5000 and CR-8000

PCB Component Libraries (EDA), PCB CAD Library Ultra Librarian

---

## Installation Notes

### Coding

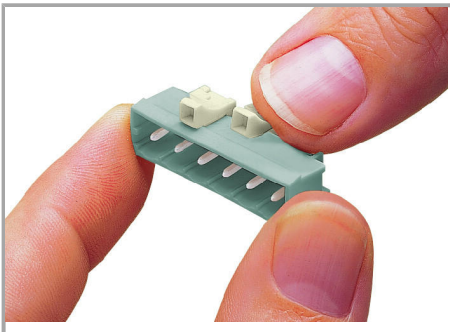

Coding a male header – fitting coding key(s).

## Familie de produse

*<i>MCS</i>* MIDI Classic  
Afișare globală produse din familie.

Supus modificărilor.

---

WAGO Kontakttechnik GmbH & Co. KG  
/Representative Office Romania  
Sos. Pipera-Tunari nr. 1/1  
building 1, 2nd floor | 077190 Voluntari, Ilfov  
Tel.: +40-(0)31 421 85 68 | Email: info-RO@wago.com

Aveți întrebări despre produsele noastre?  
Vă stăm la dispoziție pentru preluarea apelului la +40 (0) 31 421 85 68.