

Fișă tehnică | Număr articol: 2091-1107

1-conductor female plug; Gripping plate; 1.5 mm²; Pin spacing 3.5 mm; 7-pole; 1,50 mm²; light gray

www.wago.com/2091-1107

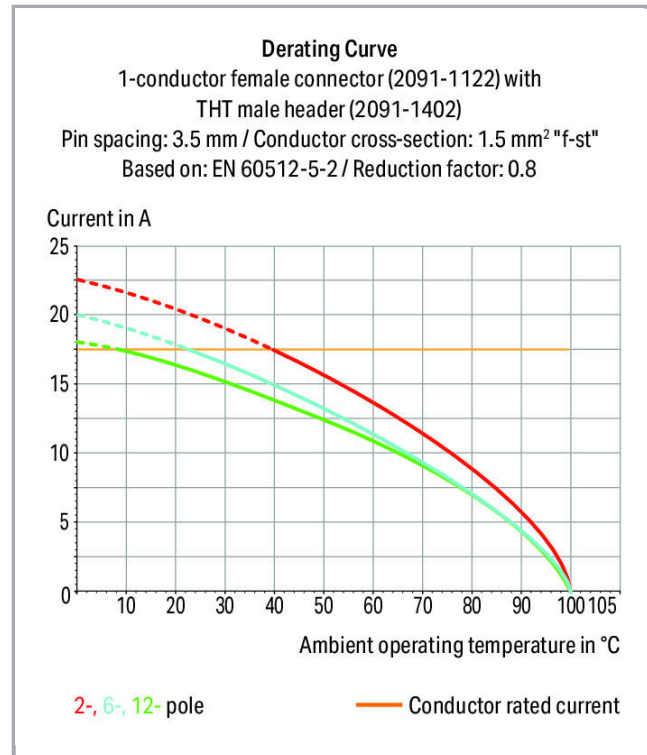

Supus modificărilor.

WAGO Kontakttechnik GmbH & Co. KG
/Representative Office Romania
Sos. Pipera-Tunari nr. 1/1
building 1, 2nd floor | 077190 Voluntari, Ilfov
Tel.: +40-(0)31 421 85 68 | Email: info-RO@wago.com

Aveți întrebări despre produsele noastre?
Vă stăm la dispoziție pentru preluarea apelului la +40 (0) 31 421 85 68.

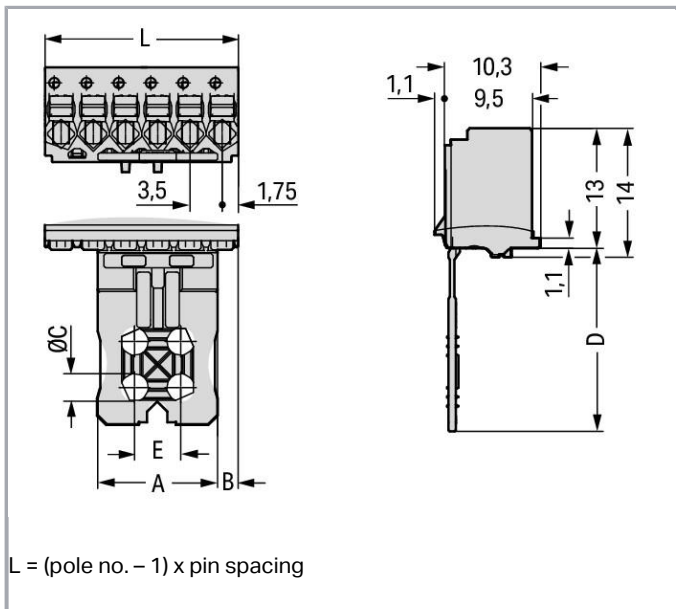

Descriere articol

- Universal connection of all conductor types
- Simple, push-in termination of solid and ferruled conductors
- Easy-to-use design does not require special tools
- Ability to wire while mated or unmated
- Testing parallel to conductor entry – tip contact
- Also available with gripping plates
- Integrated locking latches prevent accidental disconnection

Safety information 1:

The **picoMAX® pluggable connection system** is designed without breaking capacity for compliance with DIN EN 61984. When used as intended, MCS Connectors shall not be connected/disconnected when live or under load. The circuit design should ensure header pins, which can be touched, are not live when unmated.

Date

Electrical data

Ratings per IEC/EN 60664-1

| Ratings per | IEC/EN 60664-1 |
|-----------------------------|----------------|
| Nominal voltage (III/3) | 160 V |
| Rated surge voltage (III/3) | 2,5 kV |

Supus modificărilor.

WAGO Kontakttechnik GmbH & Co. KG
 /Representative Office Romania
 Sos. Pipera-Tunari nr. 1/1
 building 1, 2nd floor | 077190 Voluntari, Ilfov
 Tel.: +40-(0)31 421 85 68 | Email: info-RO@wago.com

Aveți întrebări despre produsele noastre?
 Vă stăm la dispoziție pentru preluarea apelului la +40 (0) 31 421 85 68.



| | |
|-----------------------------|---|
| Rated voltage (III/2) | 160 V |
| Rated surge voltage (III/2) | 2,5 kV |
| Nominal voltage (II/2) | 320 V |
| Rated surge voltage (II/2) | 2,5 kV |
| Rated current | 10 A |
| Legend (ratings) | (III / 2) ≙ Overvoltage category III / Pollution degree 2 |

Approvals per UL 1059

| | |
|--------------------------------|---------|
| Rated voltage UL (Use Group B) | 300 V |
| Rated current UL (Use Group B) | 10 A |
| Rated voltage UL (Use Group D) | 300 V |
| Rated current UL (Use Group D) | 10 A |
| Approvals per | UL 1059 |

Connection data

| | |
|---|---|
| Connection technology | Push-in CAGE CLAMP® |
| Actuation type | Push-button |
| Solid conductor | 0.2 ... 1.5 mm ² / 24 ... 14 AWG |
| Fine-stranded conductor | 0.2 ... 1.5 mm ² / 24 ... 14 AWG |
| Fine-stranded conductor; with insulated ferrule | 0.25 ... 0.75 mm ² |
| Fine-stranded conductor; with uninsulated ferrule | 0.25 ... 1.5 mm ² |
| Strip length | 8 ... 9 mm / 0.31 ... 0.35 inch |
| Pole No. | 7 |
| Total number of connection points | 7 |
| Total number of potentials | 7 |
| Number of connection types | 1 |
| Number of levels | 1 |

Geometrical Data

| | |
|-------------|----------------------|
| Pin spacing | 3.5 mm / 0.138 inch |
| Width | 24.5 mm / 0.965 inch |
| Height | 33 mm / 1.299 inch |
| Depth | 11.4 mm / 0.449 inch |

Mechanical data

| | |
|--------|---------------------|
| Design | With gripping plate |
|--------|---------------------|

Supus modificărilor.

WAGO Kontakttechnik GmbH & Co. KG
 /Representative Office Romania
 Sos. Pipera-Tunari nr. 1/1
 building 1, 2nd floor | 077190 Voluntari, Ilfov
 Tel.: +40-(0)31 421 85 68 | Email: info-RO@wago.com

Aveți întrebări despre produsele noastre?
 Vă stăm la dispoziție pentru preluarea apelului la +40 (0) 31 421 85 68.

Plug connection

| | |
|------------------------------------|-------------------------|
| Contact type (pluggable connector) | Female connector/socket |
| Connector (connection type) | for conductors |
| Mismating protection | No |

Material Data

| | |
|-----------------------------|--|
| Color | light gray |
| Material group | I |
| Insulation material | Polyphthalamide (PPA GF) |
| Flammability class per UL94 | V0 |
| Clamping spring material | Chrome nickel spring steel (CrNi) |
| Contact material | Electrolytic copper (E _{Cu}) |
| Contact plating | tin-plated |
| Weight | 3,7 g |

Environmental Requirements



| | |
|-------------------------|-----------------|
| Limit temperature range | -60 ... +100 °C |
|-------------------------|-----------------|

Commercial data

| | |
|-----------------------|---------------|
| Packaging type | BOX |
| Country of origin | DE |
| GTIN | 4055143478830 |
| Customs tariff number | 85366990990 |

Aprobări / certificate

Country specific Approvals

| Emblemă | Aprobare | Text de aprobare suplimentar | Nume certificat |
|--|---------------------------------------|------------------------------|------------------------|
|  | CSA DEKRA Certification B.V. | C22.2 | 2362521 |
|  | KEMA/KEUR DEKRA Certification B.V. | EN 61984 | 71- 102260 REV.1 |

Supus modificărilor.



WAGO Kontakttechnik GmbH & Co. KG
/Representative Office Romania
Sos. Pipera-Tunari nr. 1/1
building 1, 2nd floor | 077190 Voluntari, Ilfov
Tel.: +40-(0)31 421 85 68 | Email: info-RO@wago.com

Aveți întrebări despre produsele noastre?
Vă stăm la dispoziție pentru preluarea apelului la +40 (0) 31 421 85 68.

UL-Approvals

| Emblemă | Aprobare | Text de aprobare suplimentar | Nume certificat |
|--|--------------------------------------|------------------------------|---------------------|
|  | UL Underwriters Laboratories Inc. | UL 1977 | 20190909- E45171 |

Counterpart

| | | |
|--|---|--|
|  | Nr. articol 2091-1427 THT male header; 1.0 mm Ø solder pin; angled; Pin spacing 3.5 mm; 7-pole; light gray | www.wago.com/2091-1427 |
|  | Nr. articol 2091-1407 THT male header; 1.0 mm Ø solder pin; straight; Pin spacing 3.5 mm; 7-pole; light gray | www.wago.com/2091-1407 |

Produse compatibile

tools

| | | |
|--|---|--|
|  | Nr. articol: 210-719 Operating tool; Blade: 2.5 x 0.4 mm; with a partially insulated shaft | www.wago.com/210-719 |
|--|---|--|

Coding

| | | |
|--|---|--|
|  | Nr. articol: 2091-1610 Coding key carrier; suitable for 3.5 mm pin spacing; orange | www.wago.com/2091-1610 |
|--|---|--|

check

| | | |
|--|--|--|
|  | Nr. articol: 735-500 Test pin; 1 mm Ø; with solder connection for test wire | www.wago.com/735-500 |
|--|--|--|

Descărcări

Documentation

Additional Information

| | | | |
|------------------------|-------------|---------------|------------|
| Technical explanations | Apr 3, 2019 | pdf 3,6 MB | Descărcare |
|------------------------|-------------|---------------|------------|

Supus modificărilor.

Installation Notes

Locking

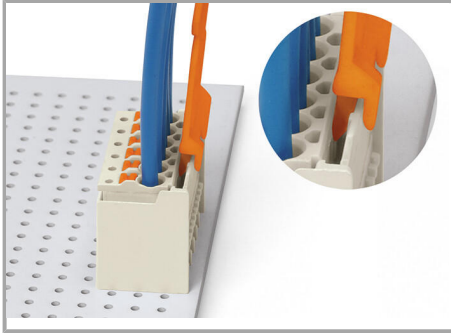

Disconnecting female connector via unlocking tool. Plug unlocking tool into the male locking latch.

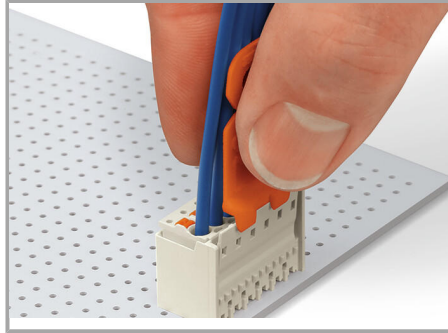

Insert unlocking tool until it hits backstop. Wedge opens locking latch.

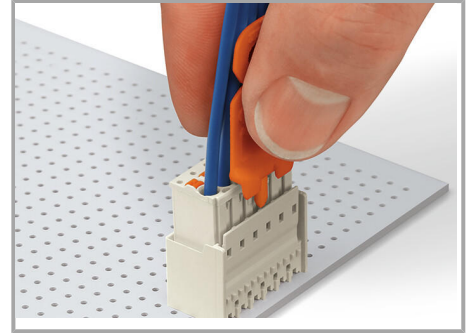

Pull on both unlocking tool and conductors to remove female connector from male header.

Conductor termination

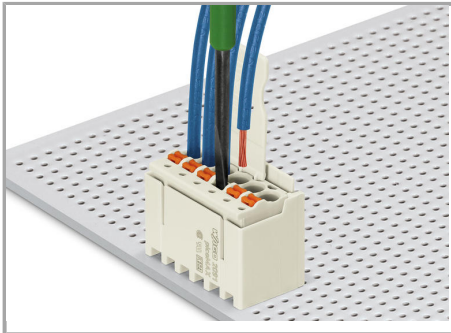

Inserting fine-stranded conductor into mated female connector via push-button.

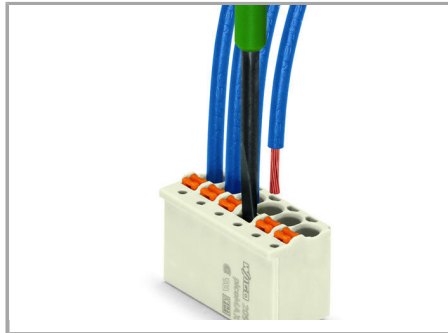

Inserting fine-stranded conductor into unmated female connector via push-button.

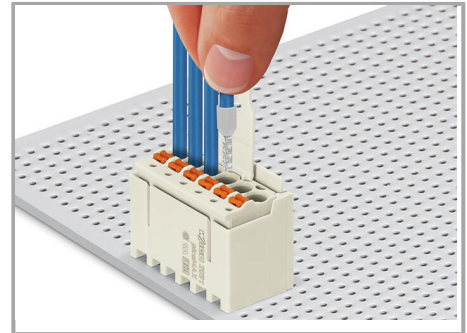

Inserting solid and ferruled conductors via push-in termination

Marking



Pole marking via factory direct printing.

Coding

Supus modificărilor.

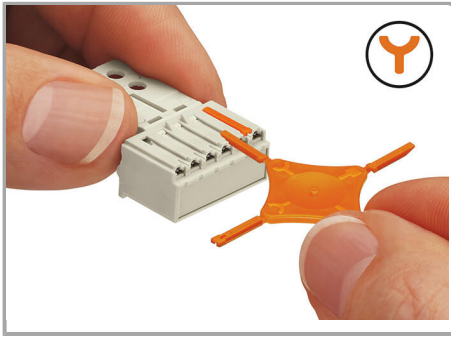

Coding a female connector (via coding key carrier and two keys for female connector, see symbol).

Testing



Testing with 1 mm Ø test pin, tip contact.

Familie de produse

picoMAX

Afișare globală produse din familie.

Supus modificărilor.