

## Fișă tehnică | Număr articol: 774-9993/216-101

pre-assembled connecting cable; Eca; Plug/open-ended; 3-pole; Cod. A;  
H05Z1Z1-F 3G 1.5 mm<sup>2</sup>; 1 m; 1,50 mm<sup>2</sup>; black

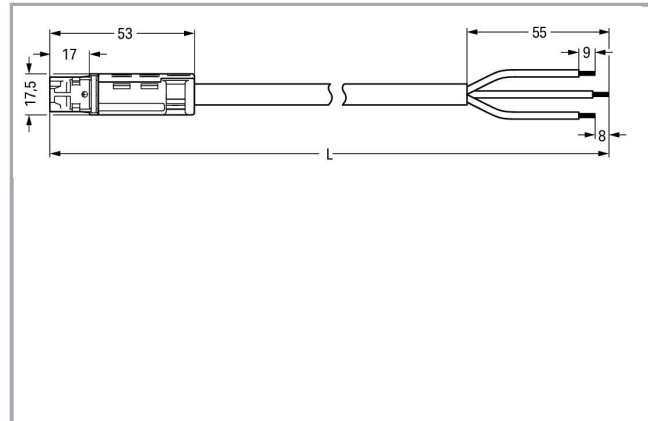

[www.wago.com/774-9993/216-101](http://www.wago.com/774-9993/216-101)

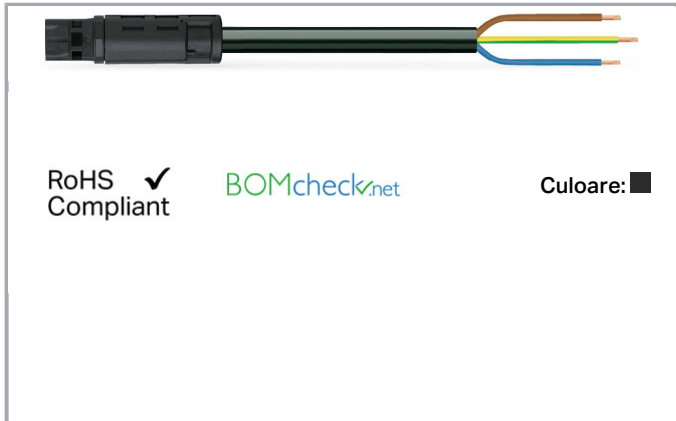

### Descriere articol

- For round conduits and ducts
- 3- and 4-pole preassembled cables with 17.5 mm outer diameter for easy plug & play
- Plug-in integration into the electrical installation of hollow-wall boxes via adapter, for example

### Note:

Cables with a different fire class can be found in the eShop.

### Note on mismatching protection:

All WINSTA<sup>®</sup> components are 100% protected against mismatching when:

- plugging different numbers of poles
- plugging while incorrectly rotated
- plugging while laterally staggered

### Date

#### Electrical data

Note on Contact Resistance

approx. 1 mΩ of contact resistance approx. 0.25 mΩ contact transition plug/socket

Supus modificărilor.

WAGO Kontakttechnik GmbH & Co. KG  
/Representative Office Romania  
Sos. Pipera-Tunari nr. 1/1  
building 1, 2nd floor | 077190 Voluntari, Ilfov  
Tel.: +40-(0)31 421 85 68 | Email: info-RO@wago.com

Aveți întrebări despre produsele noastre?  
Vă stăm la dispoziție pentru preluarea apelului la +40 (0) 31 421 85 68.



## Ratings per IEC/EN 60664-1

Ratings per	IEC/EN 60664-1
Nominal voltage (III/3)	250 V
Rated surge voltage (III/3)	4 kV
Rated current	16 A
Legend (ratings)	(III / 3) ≙ Overvoltage category III / Pollution degree 3

## Connection data

Strip length	9 mm / 0.35 inch
Pole No.	3
Total number of potentials	3
Ground function	with preceding ground contact
Conductor preparation	tip-bonded
Sheathed cable diameter	7,4 ... 9,4 mm
Wire cross-section	1,5 mm <sup>2</sup>
Strip length (outer insulation)	55 mm
Connection type	Plug - Free end

## Geometrical Data

Total length	1 m
--------------	-----

## Mechanical data

Mating force of a plug-in connection	approx. 30 ... 70 N (depending on pole number)
Retention force of a plug-in connection	when locked: > 80N
Unmating force of a plug-in connection	when unlocked: approx. 30 ... 70 N (depending on pole number)
Number of mating cycles	200, without resistive load 100, with resistive load $I_N = 20$ A, tested (2.5mm <sup>2</sup> /AWG 14)

Connection type	Plug - free end
Type of pre-assembled cable	Connecting cable
Cable type	H05Z1Z1-F 3G1.5
Marking	L N
Protection type	IP20
Note on protection type	Only when mated (these compact connectors are not designed for

Supus modificărilor.

WAGO Kontakttechnik GmbH & Co. KG  
/Representative Office Romania  
Sos. Pipera-Tunari nr. 1/1  
building 1, 2nd floor | 077190 Voluntari, Ilfov  
Tel.: +40-(0)31 421 85 68 | Email: info-RO@wago.com

Aveți întrebări despre produsele noastre?  
Vă stăm la dispoziție pentru preluarea apelului la +40 (0) 31 421 85 68.



use in open, easily accessible areas).

Application	General mains applications
-------------	----------------------------

**Plug connection**

Mismating protection	Yes
Locking of plug-in connection	locking lever

**Material Data**

Color	black
Insulation material	Polyamide 66 (PA 66)
Fire class per EN 50575	E <sub>ca</sub>
Contact material	Copper or copper alloy (surface-treated)
Fire load	1,703 MJ
Connector color	black
Strain relief color	black
Weight	99,9 g

**Environmental Requirements**

Processing temperature	-5 ... +40 °C
Continuous operating temperature	-35 ... +85 °C
Note on continuous operating temperature	PVC cable for temperatures ≤ 70 °C (including halogen-free) Insulating parts for temperatures ≤ 105 °C

**Commercial data**

Packaging type	not packed
Country of origin	DE
GTIN	4045454324605
Customs tariff number	85444290900

**Counterpart****Descărcări****CAD/CAE-Data****CAD data**

2D/3D Models 774-9993/216-101	URL	Descărcare
-------------------------------	-----	------------

Supus modificărilor.

WAGO Kontakttechnik GmbH & Co. KG  
/Representative Office Romania  
Sos. Pipera-Tunari nr. 1/1  
building 1, 2nd floor | 077190 Voluntari, Ilfov  
Tel.: +40-(0)31 421 85 68 | Email: info-RO@wago.com

Aveți întrebări despre produsele noastre?  
Vă stăm la dispoziție pentru preluarea apelului la +40 (0) 31 421 85 68.



#### CAE data

WSCAD Universe 774-9993/216-101

URL

Descărcare

---

#### Installation Notes

#### Familie de produse

<i>WINSTA</i>® RD

Afișare globală produse din familie.

Supus modificărilor.

---

WAGO Kontakttechnik GmbH & Co. KG  
/Representative Office Romania  
Sos. Pipera-Tunari nr. 1/1  
building 1, 2nd floor | 077190 Voluntari, Ilfov  
Tel.: +40-(0)31 421 85 68 | Email: info-RO@wago.com

Aveți întrebări despre produsele noastre?  
Vă stăm la dispoziție pentru preluarea apelului la +40 (0) 31 421 85 68.