

Fișă tehnică | Număr articol: 899-631/477-000

Distribution box; Single-phase current (230 V); 1 input; 11 outputs; Cod. A;
MIDI; black

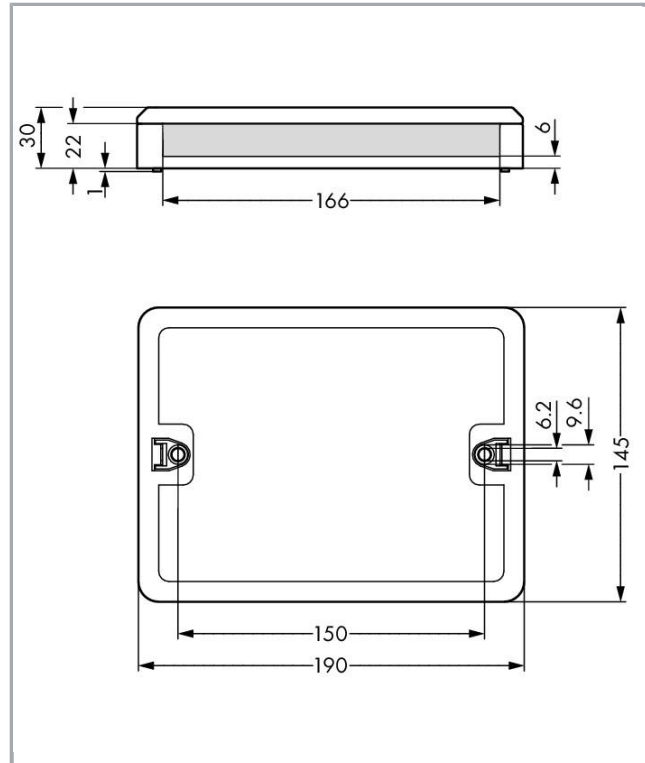

www.wago.com/899-631/477-000

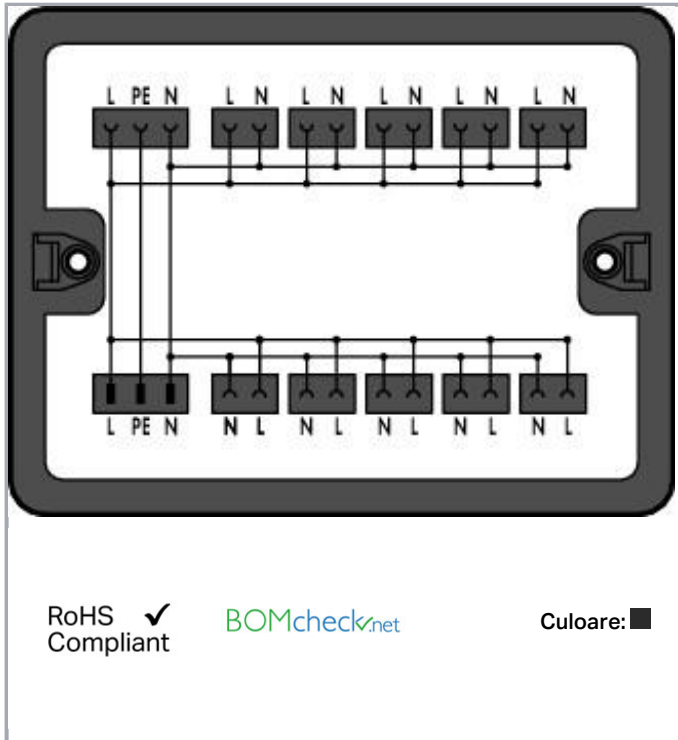

Descriere articol

Note on mismatching protection:

All WINSTA[®] components are 100% protected against mismatching when:

- plugging different numbers of poles
- plugging while rotated 180
- plugging while laterally staggered
- plugging one pole

Date

Electrical data

Note on Contact Resistance

approx. 1 mΩ of contact resistance approx. 0.25 mΩ contact transition plug/socket

Supus modificărilor.

WAGO Kontakttechnik GmbH & Co. KG
/Representative Office Romania
Sos. Pipera-Tunari nr. 1/1
building 1, 2nd floor | 077190 Voluntari, Ilfov
Tel.: +40-(0)31 421 85 68 | Email: info-RO@wago.com

Aveți întrebări despre produsele noastre?
Vă stăm la dispoziție pentru preluarea apelului la +40 (0) 31 421 85 68.



Ratings per IEC/EN 60664-1

Ratings per	IEC/EN 60664-1
Nominal voltage (III/3)	250 V
Rated surge voltage (III/3)	4 kV
Rated current	16 A
Legend (ratings)	(III / 3) ≙ Overvoltage category III / Pollution degree 3

Geometrical Data

Width	190 mm / 7.48 inch
Height	30 mm / 1.181 inch
Depth	145 mm / 5.709 inch

Mechanical data

Interne Verdrahtung	1,5 mm ²
Coding	A
Mounting type	Wall, screw mount Installation on mounting plate
Protection type	IP20
Note on protection type	Only when mated (these compact connectors are not designed for use in open, easily accessible areas).
Application	General mains applications

Plug connection

Mismating protection	Yes
Locking of plug-in connection	locking lever

Material Data

Color	black
Insulation material	Polyamide 66 (PA 66)
Contact material	Copper or copper alloy (surface-treated)
Fire load	7,347 MJ
Weight	333,8 g

Environmental Requirements

Processing temperature	-5 ... +40 °C
------------------------	---------------

Supus modificărilor.

WAGO Kontakttechnik GmbH & Co. KG
/Representative Office Romania
Sos. Pipera-Tunari nr. 1/1
building 1, 2nd floor | 077190 Voluntari, Ilfov
Tel.: +40-(0)31 421 85 68 | Email: info-RO@wago.com

Aveți întrebări despre produsele noastre?
Vă stăm la dispoziție pentru preluarea apelului la +40 (0) 31 421 85 68.

Continuous operating temperature

-35 ... +85 °C









Note on continuous operating temperature

Insulating parts for temperatures ≤ 105 °C

Commercial data

Packaging type	BOX
Country of origin	DE
GTIN	4055143932097
Customs tariff number	85366990990

Counterpart

	Nr. articol 770-103 Socket; with strain relief housing; 3-pole; Cod. A; 4,00 mm ² ; black	www.wago.com/770-103
	Nr. articol 770-112/041-000 Plug; with strain relief housing; 2-pole; Cod. A; 4,00 mm ² ; black	www.wago.com/770-112/041-000
	Nr. articol 770-113 Plug; with strain relief housing; 3-pole; Cod. A; 4,00 mm ² ; black	www.wago.com/770-113
	Nr. articol 770-203 Socket; 3-pole; Cod. A; 4,00 mm ² ; black	www.wago.com/770-203
	Nr. articol 770-212 Plug; 2-pole; Cod. A; 4,00 mm ² ; black	www.wago.com/770-212
	Nr. articol 771-8992/006-101 pre-assembled interconnecting cable; Eca; Socket/plug; 2-pole; Cod. A; H05VV-F 2 x 1.5 mm ² ; 1 m; 1,50 mm ² ; black	www.wago.com/771-8992/006-101
	Nr. articol 770-213 Plug; 3-pole; Cod. A; 4,00 mm ² ; black	www.wago.com/770-213
	Nr. articol 771-9993/006-101 pre-assembled interconnecting cable; Eca; Socket/plug; 3-pole; Cod. A; H05VV-F 3G 1.5 mm ² ; 1 m; 1,50 mm ² ; black	www.wago.com/771-9993/006-101

Installation Notes

Installation

Supus modificărilor.

WAGO Kontakttechnik GmbH & Co. KG
/Representative Office Romania
Sos. Pipera-Tunari nr. 1/1
building 1, 2nd floor | 077190 Voluntari, Ilfov
Tel.: +40-(0)31 421 85 68 | Email: info-RO@wago.com

Aveți întrebări despre produsele noastre?
Vă stăm la dispoziție pentru preluarea apelului la +40 (0) 31 421 85 68.



Securing the mounting plate with WINSTA®
Distribution Box to the wall (e.g., via stud gun).

Familie de produse

<i>WINSTA</i>® Boxen

WINSTA® ist das Steckverbindersystem, das optimal auf die hohen Anforderungen in der Gebäudeinstallation zugeschnitten ist. Es macht die Elektroinstallation steckbar und dadurch schnell, sicher und fehlerfrei. Dies gilt auch in weiteren Anwendungen wie z. B. im Schiffbau, in der Bahntechnik oder in der Industrie.

Afișare globală produse din familie.

Supus modificărilor.