

Fișă tehnică | Număr articol: 891-8994/106-102

pre-assembled connecting cable; Eca; Socket/open-ended; 4-pole; Cod. A;
H05VV-F 4G 1.5 mm²; 1 m; 1,50 mm²; white

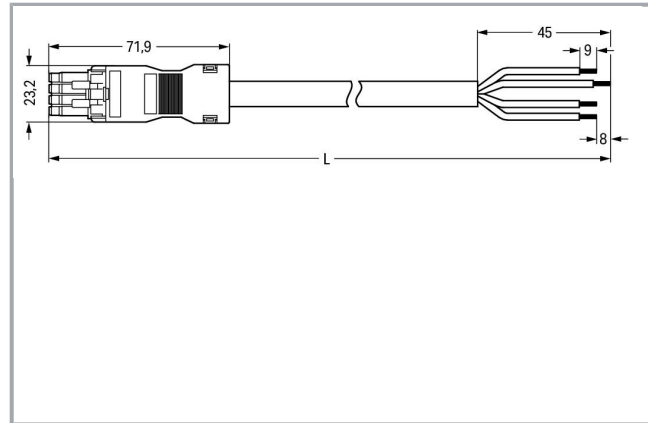

www.wago.com/891-8994/106-102

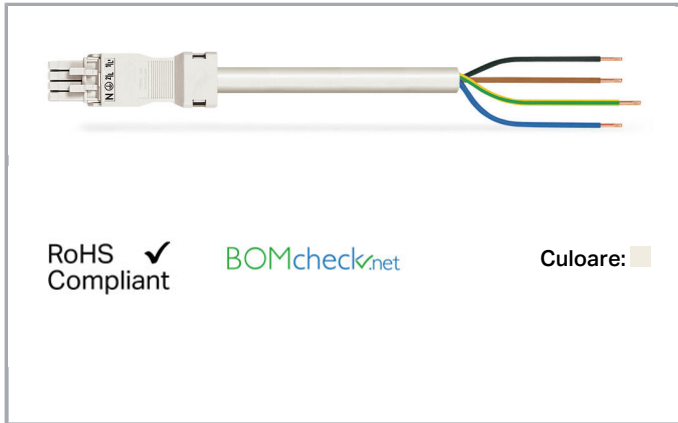

Descriere articol

- Protected against mismatching and maintenance-free
- Compact design with 4.4 mm pole spacing

Note:

Cables with a different fire class can be found in the eShop.

Note on mismatching protection:

All WINSTA[®] components are 100% protected against mismatching when:

- plugging different numbers of poles
- plugging while rotated 180
- plugging while laterally staggered
- plugging one pole

Safety information 1:

Application note for the U.S. market (USR): Some versions may also be used for current interruption in accordance with the UL certificate in select applications with currents below 5 A and voltages up to 600 V. For further information, please contact your local sales office.

Date

Electrical data

Note on Contact Resistance

approx. 1 mΩ of contact resistance approx. 0.25 mΩ contact transition plug/socket

Supus modificărilor.

WAGO Kontakttechnik GmbH & Co. KG
/Representative Office Romania
Sos. Pipera-Tunari nr. 1/1
building 1, 2nd floor | 077190 Voluntari, Ilfov
Tel.: +40-(0)31 421 85 68 | Email: info-RO@wago.com

Aveți întrebări despre produsele noastre?
Vă stăm la dispoziție pentru preluarea apelului la +40 (0) 31 421 85 68.

Ratings per IEC/EN 60664-1

| | |
|-----------------------------|---|
| Ratings per | IEC/EN 60664-1 |
| Nominal voltage (III/3) | 400 V |
| Rated surge voltage (III/3) | 6 kV |
| Rated current | 16 A |
| Legend (ratings) | (III / 3) ≙ Overvoltage category III / Pollution degree 3 |

Approvals per UL 1977

| | |
|-----------------------|-------|
| Rated voltage UL 1977 | 600 V |
| Rated current UL 1977 | 12 A |

Connection data

| | |
|---------------------------------|-------------------------------|
| Strip length | 9 mm / 0.35 inch |
| Pole No. | 4 |
| Total number of potentials | 4 |
| Ground function | with preceding ground contact |
| Conductor preparation | tip-bonded |
| Sheathed cable diameter | 8,4 ... 10,5 mm |
| Wire cross-section | 1,5 mm ² |
| Strip length (outer insulation) | 45 mm |
| Connection type | Socket - Free end |

Geometrical Data

| | |
|--------------|---------------------|
| Pin spacing | 4,4 mm / 0.173 inch |
| Total length | 1 m |

Mechanical data

| | |
|---|---|
| Coding | A |
| Mating force of a plug-in connection | approx. 20 ... 70 N (depending on pole number) |
| Retention force of a plug-in connection | when locked: > 80N |
| Unmating force of a plug-in connection | when unlocked: approx. 20 ... 70 N (depending on pole number) |
| Number of mating cycles | 200, without resistive load 100, with resistive load $I_N = 16$ A, tested (1.5mm ² /AWG 16) |

Supus modificărilor.



| | |
|-----------------------------|----------------------------|
| Connection type | Socket - free end |
| Type of pre-assembled cable | Connecting cable |
| Cable type | H05VV-F 4G1.5 |
| Marking | N 2/L 1/L' |
| Protection type | IP40 |
| Potential marking | N 2/L 1/L' |
| Application | General mains applications |

Plug connection

| | |
|-------------------------------|---------------|
| Mismatching protection | Yes |
| Locking of plug-in connection | locking lever |
| Locking lever | retrofitable |

Material Data

| | |
|----------------------------------|--|
| Color | white |
| Insulation material | Polyamide 66 (PA 66) |
| Fire class per EN 50575 | E _{ca} |
| Contact material | Copper or copper alloy (surface-treated) |
| Fire load | 2,402 MJ |
| Connector color | white |
| Printing color of mating face | black |
| Strain relief color | white |
| Printing color of strain relief | black |
| Sheathed cable color | white |
| Printing color of sheathed cable | black |
| Sheath material | PVC |
| Weight | 142,3 g |

Environmental Requirements

| | |
|--|---|
| Processing temperature | -5 ... +40 °C |
| Continuous operating temperature | -35 ... +85 °C |
| Note on continuous operating temperature | PVC cable for temperatures ≤ 70 °C (including halogen-free) Insulating parts for temperatures ≤ 105 °C |

Commercial data

| | |
|----------------|------------|
| Packaging type | not packed |
|----------------|------------|

Supus modificărilor.

WAGO Kontakttechnik GmbH & Co. KG
/Representative Office Romania
Sos. Pipera-Tunari nr. 1/1
building 1, 2nd floor | 077190 Voluntari, Ilfov
Tel.: +40-(0)31 421 85 68 | Email: info-RO@wago.com

Aveți întrebări despre produsele noastre?
Vă stăm la dispoziție pentru preluarea apelului la +40 (0) 31 421 85 68.





| | |
|-----------------------|---------------|
| Country of origin | PL |
| GTIN | 4055143404259 |
| Customs tariff number | 85444290900 |

Aprobări / certificate

Country specific Approvals

| Emblemă | Aprobare | Text de aprobare suplimentar | Nume certificat |
|--|--|------------------------------|-----------------|
|  | KEMA/KEUR DEKRA Certification B.V. | EN 61535 | 2179129.02 |

Counterpart

| | | |
|---|---|--|
|  | Nr. articol890-134 Plug; with strain relief housing; 4-pole; 1,50 mm ² ; white | www.wago.com/890-134 |
|  | Nr. articol890-234 Plug; 4-pole; 1,50 mm ² ; white | www.wago.com/890-234 |
|  | Nr. articol890-676 T-distribution connector; 4-pole; Cod. A; 1 input; 2 outputs; 2 locking levers; white | www.wago.com/890-676 |
|  | Nr. articol890-677 T-distribution connector; 4-pole; Cod. A; 1 input; 2 outputs; 3 locking levers; for flying leads; white | www.wago.com/890-677 |
|  | Nr. articol890-734 Snap-in plug; 4-pole; Cod. A; 1,50 mm ² ; white | www.wago.com/890-734 |
|  | Nr. articol890-834 Plug for PCBs; straight; 4-pole; Cod. A | www.wago.com/890-834 |
|  | Nr. articol890-994 h-distribution connector; 4-pole; Cod. A; 1 input; 2 outputs; outputs on one side; 2 locking levers; white | www.wago.com/890-994 |

Supus modificărilor.

WAGO Kontakttechnik GmbH & Co. KG
/Representative Office Romania
Sos. Pipera-Tunari nr. 1/1
building 1, 2nd floor | 077190 Voluntari, Ilfov
Tel.: +40-(0)31 421 85 68 | Email: info-RO@wago.com

Aveți întrebări despre produsele noastre?
Vă stăm la dispoziție pentru preluarea apelului la +40 (0) 31 421 85 68.



Nr. articol 890-834/011-000
Plug for PCBs; angled; 4-pole; Cod. A

www.wago.com/890-834/011-000



Nr. articol 890-995
h-distribution connector; 4-pole; Cod. A; 1 input; 2 outputs; outputs on one side; 3 locking levers; for flying leads; white

www.wago.com/890-995

Descărcări

CAD/CAE-Data

CAE data

WSCAD Universe 891-8994/106-102

URL

Descărcare

Installation Notes

Familie de produse

WINSTA® MINI

Afișare globală produse din familie.

Supus modificărilor.