

Fișă tehnică | Număr articol: 731-517/031-000

1-conductor female plug; angled; clamping collar; 2.5 mm²; Pin spacing 5 mm; 17-pole; 2,50 mm²; gray

www.wago.com/731-517/031-000

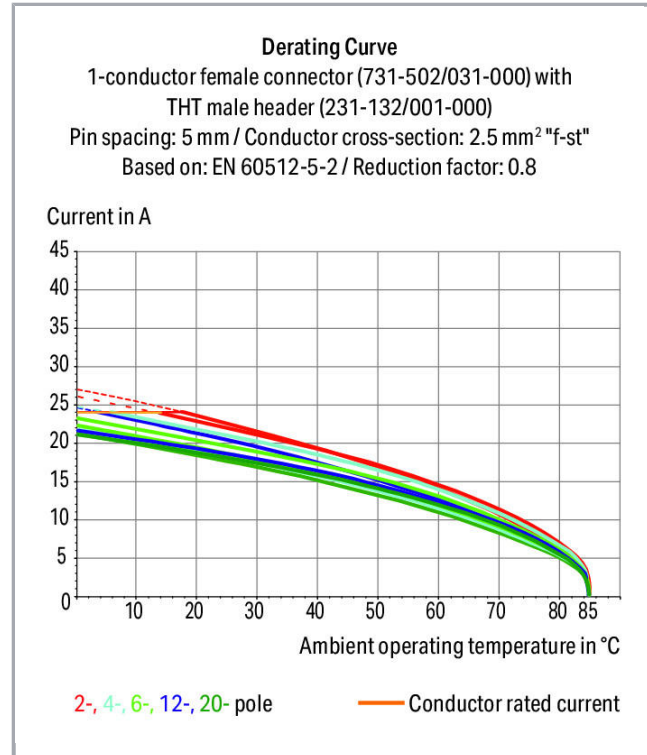

Supus modificărilor.

WAGO Kontakttechnik GmbH & Co. KG
/Representative Office Romania
Sos. Pipera-Tunari nr. 1/1
building 1, 2nd floor | 077190 Voluntari, Ilfov
Tel.: +40-(0)31 421 85 68 | Email: info-RO@wago.com

Aveți întrebări despre produsele noastre?
Vă stăm la dispoziție pentru preluarea apelului la +40 (0) 31 421 85 68.

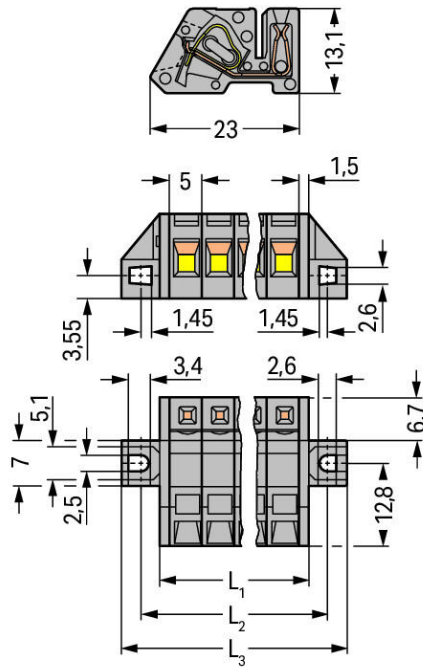

$L_1 = (\text{pole no.} \times \text{pin spacing}) + 3 \text{ mm}$

$L_2 = (\text{pole no.} \times \text{pin spacing}) + 8.8 \text{ mm}$

$L_3 = (\text{pole no.} \times \text{pin spacing}) + 14.8 \text{ mm}$

Descriere articol

- Universal connection for all conductor types
- Versions available with snap-in mounting feet or flanges for panel or through-panel mounting
- Mounting adapter allows versions with snap-in mounting feet to be DIN-rail mounted
- Easy conductor termination, even when halves are mated

Safety information 1:

The *MULTI CONNECTION SYSTEM (MCS)* is designed without breaking capacity for compliance with DIN EN 61984. When used as intended, MCS Connectors shall not be connected/disconnected when live or under load. The circuit design should ensure header pins, which can be touched, are not live when unmated.

Supus modificărilor.

WAGO Kontakttechnik GmbH & Co. KG
 /Representative Office Romania
 Sos. Pipera-Tunari nr. 1/1
 building 1, 2nd floor | 077190 Voluntari, Ilfov
 Tel.: +40-(0)31 421 85 68 | Email: info-RO@wago.com

Aveți întrebări despre produsele noastre?

Vă stăm la dispoziție pentru preluarea apelului la +40 (0) 31 421 85 68.

**Date****Electrical data****Ratings per IEC/EN 60664-1**

Ratings per	IEC/EN 60664-1
Nominal voltage (III/3)	320 V
Rated surge voltage (III/3)	4 kV
Rated voltage (III/2)	320 V
Rated surge voltage (III/2)	4 kV
Nominal voltage (II/2)	630 V
Rated surge voltage (II/2)	4 kV
Rated current	12 A
Legend (ratings)	(III / 2) ≙ Overvoltage category III / Pollution degree 2

Approvals per UL 1059

Rated voltage UL (Use Group B)	300 V
Rated current UL (Use Group B)	15 A
Rated voltage UL (Use Group D)	300 V
Rated current UL (Use Group D)	10 A
Approvals per	UL 1059

Approvals per UL 1977

Rated voltage UL 1977	600 V
Rated current UL 1977	15 A

Approvals per CSA

Rated voltage CSA (Use Group B)	300 V
Rated current CSA (Use Group B)	15 A
Rated voltage CSA (Use Group D)	300 V
Rated current CSA (Use Group D)	10 A

Connection data

Connection technology	CAGE CLAMP®
Actuation type	Operating tool
Solid conductor	0.08 ... 2.5 mm ² / 28 ... 12 AWG
Fine-stranded conductor	0.08 ... 2.5 mm ² / 28 ... 12 AWG

Supus modificărilor.

WAGO Kontakttechnik GmbH & Co. KG
 /Representative Office Romania
 Sos. Pipera-Tunari nr. 1/1
 building 1, 2nd floor | 077190 Voluntari, Ilfov
 Tel.: +40-(0)31 421 85 68 | Email: info-RO@wago.com

Aveți întrebări despre produsele noastre?
 Vă stăm la dispoziție pentru preluarea apelului la +40 (0) 31 421 85 68.



Fine-stranded conductor; with insulated ferrule	0.25 ... 1.5 mm ²
Fine-stranded conductor; with uninsulated ferrule	0.25 ... 2.5 mm ²
Strip length	7 ... 8 mm / 0.28 ... 0.31 inch
Pole No.	17
Total number of connection points	17
Total number of potentials	17
Number of connection types	1
Number of levels	1
Conductor entry direction to mating direction	90°

Geometrical Data

Pin spacing	5 mm / 0.197 inch
Width	99.8 mm / 3.929 inch
Height	13.1 mm / 0.516 inch
Depth	23 mm / 0.906 inch

Mechanical data

Design	angled; mountable
Mounting type	Mounting flange
Mounting type	Feed-through mounting Panel mounting

Plug connection

Contact type (pluggable connector)	Female connector/socket
Connector (connection type)	for conductors
Mismating protection	No

Material Data

Color	gray
Material group	I
Insulation material	Polyamide 66 (PA 66)
Flammability class per UL94	V0
Clamping spring material	Chrome nickel spring steel (CrNi)
Contact material	Copper alloy
Contact plating	tin-plated
Fire load	0,485 MJ
Weight	24,8 g

Supus modificărilor.

WAGO Kontakttechnik GmbH & Co. KG
/Representative Office Romania
Sos. Pipera-Tunari nr. 1/1
building 1, 2nd floor | 077190 Voluntari, Ilfov
Tel.: +40-(0)31 421 85 68 | Email: info-RO@wago.com

Aveți întrebări despre produsele noastre?
Vă stăm la dispoziție pentru preluarea apelului la +40 (0) 31 421 85 68.

Environmental Requirements



Limit temperature range	-60 ... +85 °C
-------------------------	----------------

Commercial data

Product Group	3 (Multi Conn. System)
Packaging type	BOX
Country of origin	PL
GTIN	4044918575331
Customs tariff number	85366990990

Aprobări / certificate

Country specific Approvals

Emblemă	Aprobare	Text de aprobare suplimentar	Nume certificat
	CSA DEKRA Certification B.V.	C22.2	1466354
	KEMA/KEUR DEKRA Certification B.V.	EN 61984	2190761.01

Ship Approvals

Emblemă	Aprobare	Text de aprobare suplimentar	Nume certificat
	ABS American Bureau of Shipping	-	19- HG1869876- PDA

UL-Approvals

Emblemă	Aprobare	Text de aprobare suplimentar	Nume certificat
	UL Underwriters Laboratories Inc.	UL 1977	E45171
	UL Underwriters Laboratories Inc.	UL 1059	20190731- E45172

Supus modificărilor.

WAGO Kontakttechnik GmbH & Co. KG
/Representative Office Romania
Sos. Pipera-Tunari nr. 1/1
building 1, 2nd floor | 077190 Voluntari, Ilfov
Tel.: +40-(0)31 421 85 68 | Email: info-RO@wago.com

Aveți întrebări despre produsele noastre?
Vă stăm la dispoziție pentru preluarea apelului la +40 (0) 31 421 85 68.



Counterpart



Nr. articol231-617

1-conductor male connector; 2.5 mm²; Pin spacing 5 mm; 17-pole; 2,50 mm²; gray

www.wago.com/231-617

Produse compatibile

Marking accessories

Nr. articol: 210-332/500-202

Marking strips; as a DIN A4 sheet; MARKED; 1-16 (160x); Height of marker strip: 3 mm; Strip length 182 mm; Horizontal marking; Self-adhesive; white

www.wago.com/210-332/500-202

Nr. articol: 210-332/500-204

Marking strips; as a DIN A4 sheet; MARKED; 17-32 (160x); Height of marker strip: 3 mm; Strip length 182 mm; Horizontal marking; Self-adhesive; white

www.wago.com/210-332/500-204

Nr. articol: 210-332/500-205

Marking strips; as a DIN A4 sheet; MARKED; 1-32 (80x); Height of marker strip: 3 mm; Strip length 182 mm; Horizontal marking; Self-adhesive; white

www.wago.com/210-332/500-205

Nr. articol: 210-332/500-206

Marking strips; as a DIN A4 sheet; MARKED; 33-48 (160x); Height of marker strip: 3 mm; Strip length 182 mm; Horizontal marking; Self-adhesive; white

www.wago.com/210-332/500-206



Nr. articol: 210-833

Marking strips; on reel; 6 mm wide; plain; Self-adhesive; white

www.wago.com/210-833



Nr. articol: 210-834

Marking strips; on reel; 5 mm wide; plain; Self-adhesive; white

www.wago.com/210-834

tools



Nr. articol: 209-130

Operating tool; suitable for 264, 280 and 281 Series; 1-way; of insulating material

www.wago.com/209-130



















Nr. articol: 210-657

Operating tool; Blade: 3.5 x 0.5 mm; with a partially insulated shaft; short

www.wago.com/210-657

Supus modificărilor.

	Nr. articol: 210-720 Operating tool; Blade: 3.5 x 0.5 mm; with a partially insulated shaft	www.wago.com/210-720
	Nr. articol: 231-131 Push-button; loose	www.wago.com/231-131
	Nr. articol: 231-159 Operating tool; natural	www.wago.com/231-159
	Nr. articol: 231-231 Combination operating tool; red	www.wago.com/231-231
	Nr. articol: 231-291 Operating tool; loose; red	www.wago.com/231-291
	Nr. articol: 280-432 Operating tool; made of insulating material; 2-way	www.wago.com/280-432
	Nr. articol: 280-433 Operating tool; made of insulating material; 3-way	www.wago.com/280-433
	Nr. articol: 280-434 Operating tool; made of insulating material; 4-way	www.wago.com/280-434
	Nr. articol: 280-435 Operating tool; made of insulating material; 5-way; gray	www.wago.com/280-435
	Nr. articol: 280-436 Operating tool; made of insulating material; 6-way	www.wago.com/280-436
	Nr. articol: 280-437 Operating tool; made of insulating material; 7-way	www.wago.com/280-437
	Nr. articol: 280-438 Operating tool; made of insulating material; 8-way	www.wago.com/280-438
	Nr. articol: 280-440 Operating tool; made of insulating material; 10-way	www.wago.com/280-440
assembling		
	Nr. articol: 209-147 Self-tapping screw	www.wago.com/209-147
	Nr. articol: 231-194 Self-tapping screw; B 2.2x13, fixing hole 1.8 mm Ø	www.wago.com/231-194
	Nr. articol: 231-195 Screw with nut; M2x12; for fixing element	www.wago.com/231-195
	Nr. articol: 231-295 Screw with nut	www.wago.com/231-295

Jumper

Nr. articol: 231-902

Supus modificărilor.



Comb-style jumper bar; for 5 mm and 5.08 mm pin spacing; reduces conductor size to 1.5 mm; gray www.wago.com/231-902



Nr. articol: 231-903

Comb-style jumper bar; 3-way; suitable for 231 Series female connectors; with 5 mm pin spacing; insulated; gray www.wago.com/231-903



Nr. articol: 231-905

Comb-style jumper bar; 5-way; suitable for 231 Series female connectors; with 5 mm pin spacing; insulated; gray www.wago.com/231-905



Nr. articol: 231-907

Comb-style jumper bar; 7-way; suitable for 231 Series female connectors; with 5 mm pin spacing; insulated; gray www.wago.com/231-907



Nr. articol: 231-910

Comb-style jumper bar; 10-way; suitable for 231 Series female connectors; with 5 mm pin spacing; insulated; gray www.wago.com/231-910

ferrule



Nr. articol: 216-106

Ferrule; Sleeve for 2.5 mm² / AWG 14; uninsulated; electro-tin plated www.wago.com/216-106



Nr. articol: 216-121

Ferrule; Sleeve for 0.5 mm² / AWG 22; uninsulated; electro-tin plated www.wago.com/216-121



Nr. articol: 216-122

Ferrule; Sleeve for 0.75 mm² / AWG 20; uninsulated; electro-tin plated www.wago.com/216-122



Nr. articol: 216-123

Ferrule; Sleeve for 1 mm² / AWG 18; uninsulated; electro-tin plated www.wago.com/216-123



Nr. articol: 216-124

Ferrule; Sleeve for 1.5 mm² / AWG 16; uninsulated; electro-tin plated www.wago.com/216-124



Nr. articol: 216-131

Ferrule; Sleeve for 0.25 mm² / AWG 24; uninsulated; electro-tin plated www.wago.com/216-131



Nr. articol: 216-132

Ferrule; Sleeve for 0.34 mm² / AWG 24; uninsulated; electro-tin plated www.wago.com/216-132



Nr. articol: 216-141

Ferrule; Sleeve for 0.5 mm² / 20 AWG; uninsulated; electro-tin plated; electrolytic copper; gastight crimped; acc. to DIN 46228, Part 1/08.92 www.wago.com/216-141



Nr. articol: 216-142

Ferrule; Sleeve for 0.75 mm² / 18 AWG; uninsulated; electro-tin plated; electrolytic copper; gastight crimped; acc. to DIN 46228, Part 1/08.92 www.wago.com/216-142



Nr. articol: 216-143

















Ferrule; Sleeve for 1 mm² / AWG 18; uninsulated; electro-tin plated; electrolytic copper; gastight crimped; acc. to DIN 46228, Part 1/08.92 www.wago.com/216-143



Nr. articol: 216-144



Ferrule; Sleeve for 1.5 mm² / AWG 16; uninsulated; electro-tin plated; electrolytic copper; gastight crimped; acc. to DIN 46228, Part 1/08.92 www.wago.com/216-144

Supus modificărilor.

	Nr. articol: 216-151 Ferrule; Sleeve for 0.25 mm ² / AWG 24; uninsulated; electro-tin plated	www.wago.com/216-151
	Nr. articol: 216-152 Ferrule; Sleeve for 0.34 mm ² / AWG 24; uninsulated; electro-tin plated	www.wago.com/216-152
	Nr. articol: 216-221 Ferrule; Sleeve for 0.5 mm ² / 20 AWG; insulated; electro-tin plated; white	www.wago.com/216-221
	Nr. articol: 216-222 Ferrule; Sleeve for 0.75 mm ² / 18 AWG; insulated; electro-tin plated; gray	www.wago.com/216-222
	Nr. articol: 216-223 Ferrule; Sleeve for 1 mm ² / AWG 18; insulated; electro-tin plated; red	www.wago.com/216-223
	Nr. articol: 216-224 Ferrule; Sleeve for 1.5 mm ² / AWG 16; insulated; electro-tin plated; black	www.wago.com/216-224
	Nr. articol: 216-241 Ferrule; Sleeve for 0.5 mm ² / 20 AWG; insulated; electro-tin plated; electrolytic copper; gastight crimped; acc. to DIN 46228, Part 4/09.90; white	www.wago.com/216-241
	Nr. articol: 216-242 Ferrule; Sleeve for 0.75 mm ² / 18 AWG; insulated; electro-tin plated; electrolytic copper; gastight crimped; acc. to DIN 46228, Part 4/09.90; gray	www.wago.com/216-242
	Nr. articol: 216-243 Ferrule; Sleeve for 1 mm ² / AWG 18; insulated; electro-tin plated; electrolytic copper; gastight crimped; acc. to DIN 46228, Part 4/09.90; red	www.wago.com/216-243
	Nr. articol: 216-244 Ferrule; Sleeve for 1.5 mm ² / AWG 16; insulated; electro-tin plated; electrolytic copper; gastight crimped; acc. to DIN 46228, Part 4/09.90; black	www.wago.com/216-244
	Nr. articol: 216-246 Ferrule; Sleeve for 2.5 mm ² / AWG 14; insulated; electro-tin plated; electrolytic copper; gastight crimped; acc. to DIN 46228, Part 4/09.90; blue	www.wago.com/216-246
	Nr. articol: 216-262 Ferrule; Sleeve for 0.75 mm ² / 18 AWG; insulated; electro-tin plated; electrolytic copper; gastight crimped; acc. to DIN 46228, Part 4/09.90; gray	www.wago.com/216-262
	Nr. articol: 216-263 Ferrule; Sleeve for 1 mm ² / AWG 18; insulated; electro-tin plated; electrolytic copper; gastight crimped; acc. to DIN 46228, Part 4/09.90; red	www.wago.com/216-263
	Nr. articol: 216-264 Ferrule; Sleeve for 1.5 mm ² / AWG 16; insulated; electro-tin plated; electrolytic copper; gastight crimped; acc. to DIN 46228, Part 4/09.90; black	www.wago.com/216-264
	Nr. articol: 216-284 Ferrule; Sleeve for 1.5 mm ² / AWG 16; insulated; electro-tin plated; electrolytic copper; gastight crimped; acc. to DIN 46228, Part 4/09.90; black	www.wago.com/216-284
	Nr. articol: 216-321 Ferrule; Sleeve for 0.25 mm ² / AWG 24; insulated; electro-tin plated; yellow	www.wago.com/216-321
	Nr. articol: 216-322 Ferrule; Sleeve for 0.34 mm ² / 22 AWG; insulated; electro-tin plated; green	www.wago.com/216-322

Supus modificărilor.

check

	Nr. articol: 210-136 Test plug; 2 mm Ø; with 500 mm cable; red	www.wago.com/210-136
	Nr. articol: 210-137 Test plug; 2.3 mm Ø; with 500 mm cable; yellow	www.wago.com/210-137
	Nr. articol: 231-661 Test plugs for female connectors; for 5 mm and 5.08 mm pin spacing; 2,50 mm ² ; light gray	www.wago.com/231-661

Descărcări

Documentation

Additional Information

Technical explanations	Apr 3, 2019	pdf 3,6 MB	Descărcare
------------------------	-------------	---------------	------------

CAD/CAE-Data

CAD data

2D/3D Models 731-517/031-000	URL	Descărcare
------------------------------	-----	------------

CAE data

EPLAN Data Portal 731-517/031-000	URL	Descărcare
-----------------------------------	-----	------------

Installation Notes

Application

Supus modificărilor.



Angled female plug – a male header with straight solder pins is used for horizontal PCB mounting in narrow housings.

Application



Angled female connector used as through-panel connector.

Termination ports and operating slots are located outside the housing – panel thickness up to 2 mm.

Familie de produse

<i>MCS</i> MIDI Classic

Afișare globală produse din familie.

Supus modificărilor.